

DX3

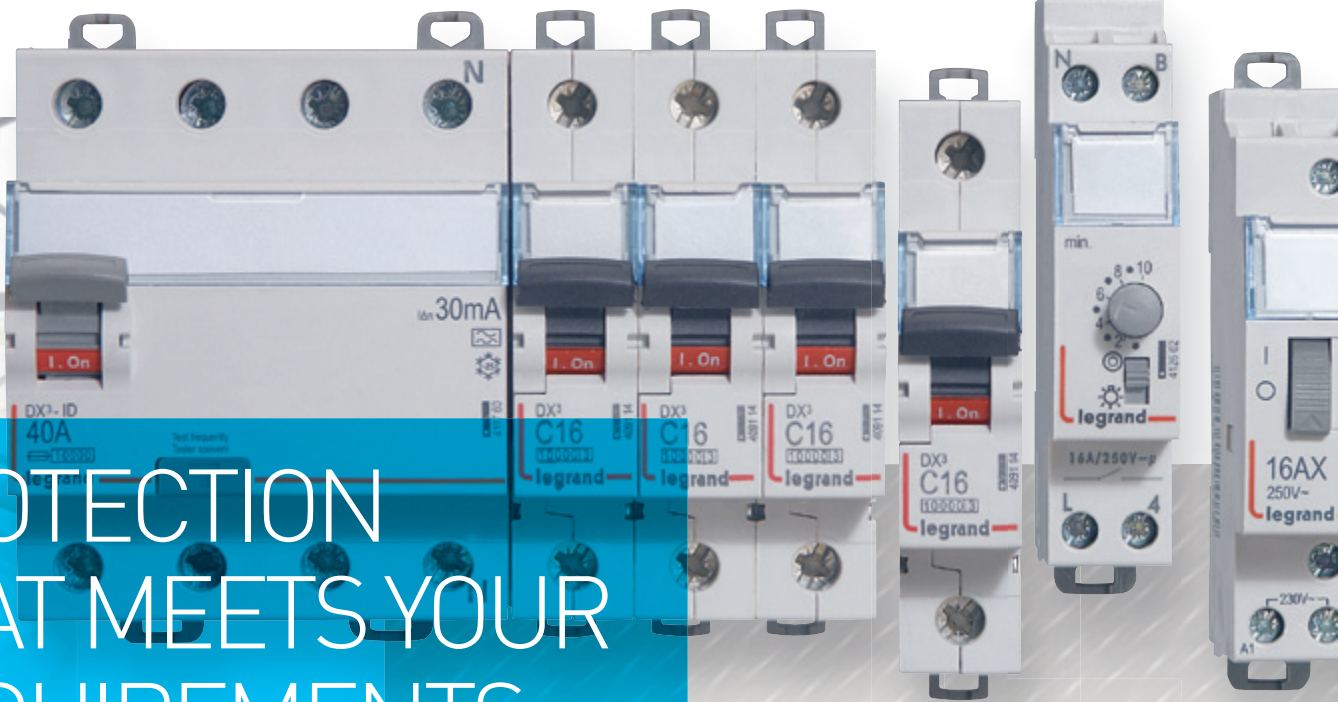

PROTECTION
THAT MEETS YOUR
REQUIREMENTS

→ [CATALOGUE PAGES INSIDE](#)

GLOBAL SPECIALIST IN ELECTRICAL AND
DIGITAL BUILDING INFRASTRUCTURES

 **legrand**[®]

THE NEW DX³ OFFER

Legrand offers you leading-edge technical features with its new DX³ range of modular circuit breakers.

This range, up to 125 A, is suitable for all residential, commercial and industrial applications which require high performance, selectivity and back-up combination of devices. In this document, discover the innovations of this new range which will enable you to build more reliable, higher performance and more economical distribution boards.

PROTECTION/BREAKING

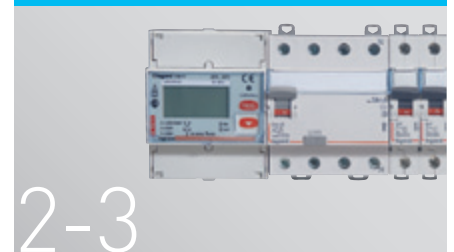

A clear, comprehensive offer for all types of application

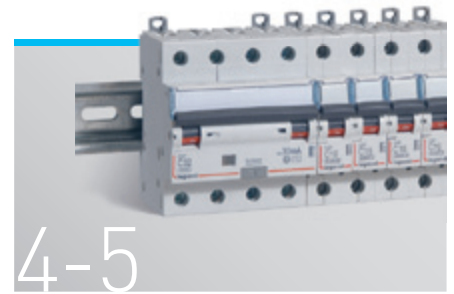

Performance that meets your requirements



Clear identification of each circuit





8-9

Impeccable quality

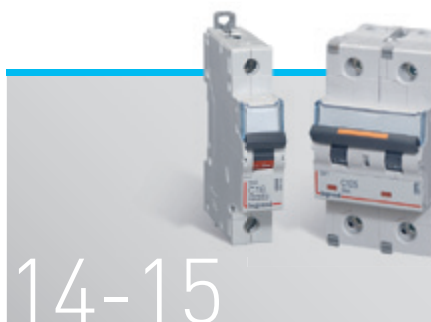

14-15

Easy, safe connection

CONTROL



22-23

More comfortable buildings and energy savings

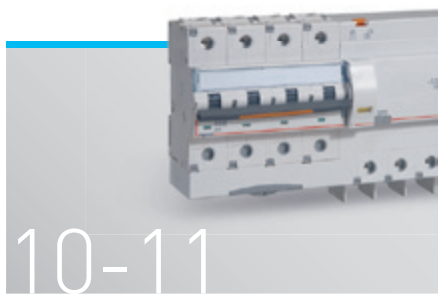

10-11

Protection tailored to your requirements

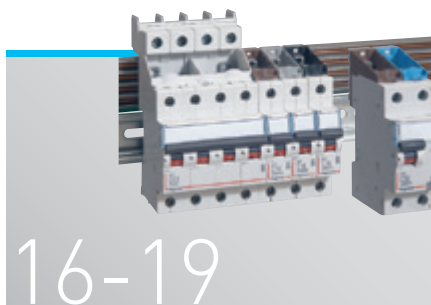

16-19

Choose your distribution

MEASUREMENT



24-25

Measurement at the heart of energy efficiency

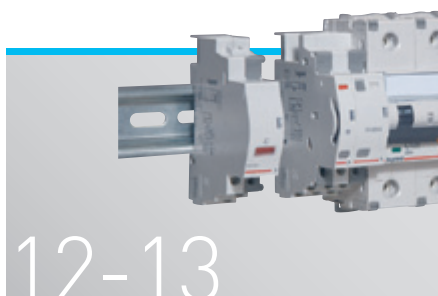

12-13

Perfect control of your installation

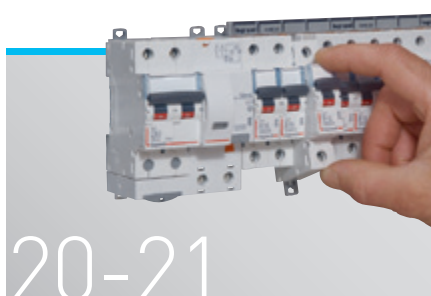

20-21

Easy operation and maintenance

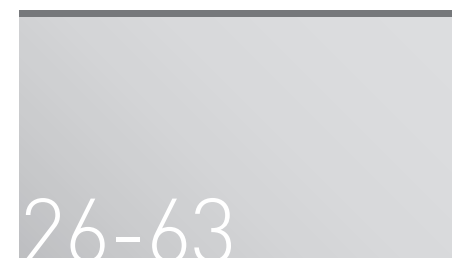

26-63

Catalogue pages

LEGRAND, A CLEAR, COMPREHENSIVE OFFER FOR ALL TYPES OF APPLICATION

The new DX³ circuit breakers

can be integrated in a wide range of products, providing exceptional technical and economic performance levels

The variety of functions and range of characteristics offered will enable you to equip all your distribution boards. The very high levels of coordination between the various ranges of DX³ modular circuit breakers or between DX³ modular circuit breakers and DPX³ MCCBs enable the cost of the installation to be optimised.

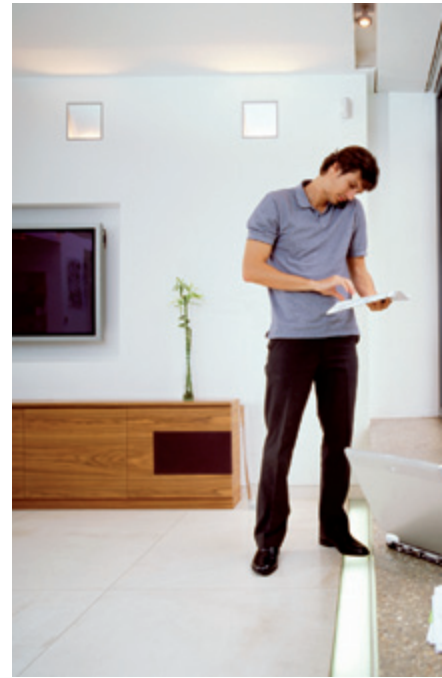

MEASUREMENT

PROTECTION/BREAKING

CONTROL

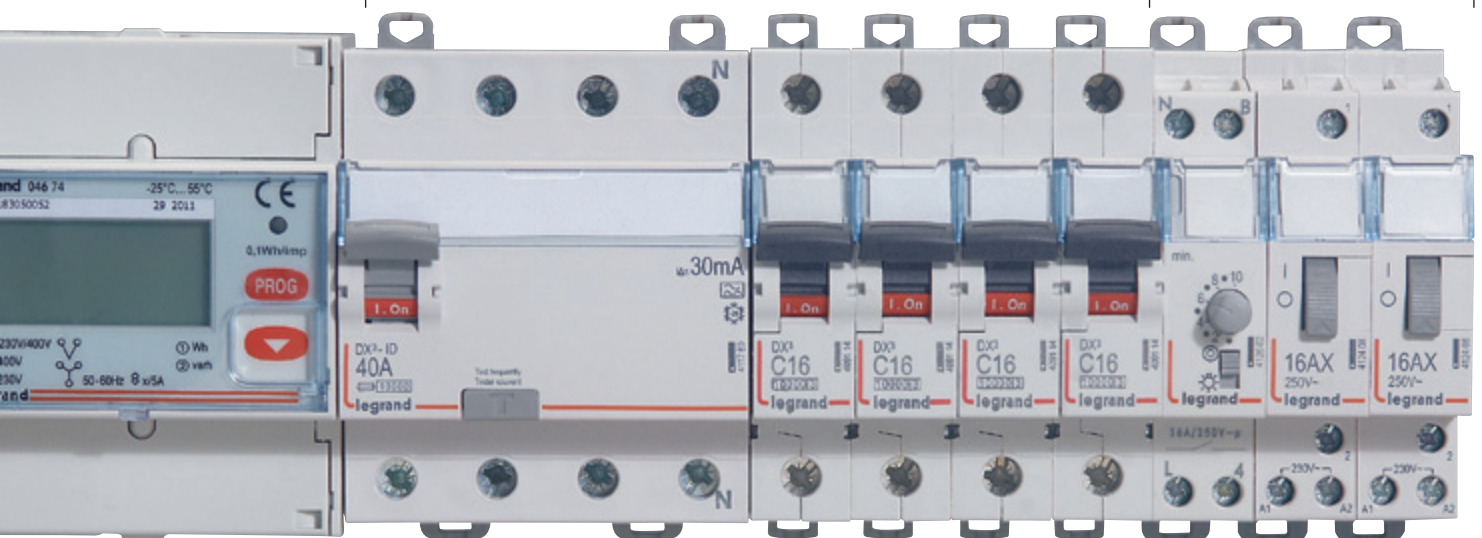

All functions on DIN rail



Each breaking capacity has its own power solution

Perfect complementarity for your distribution boards up to 6300 A and 100 kA breaking capacity.

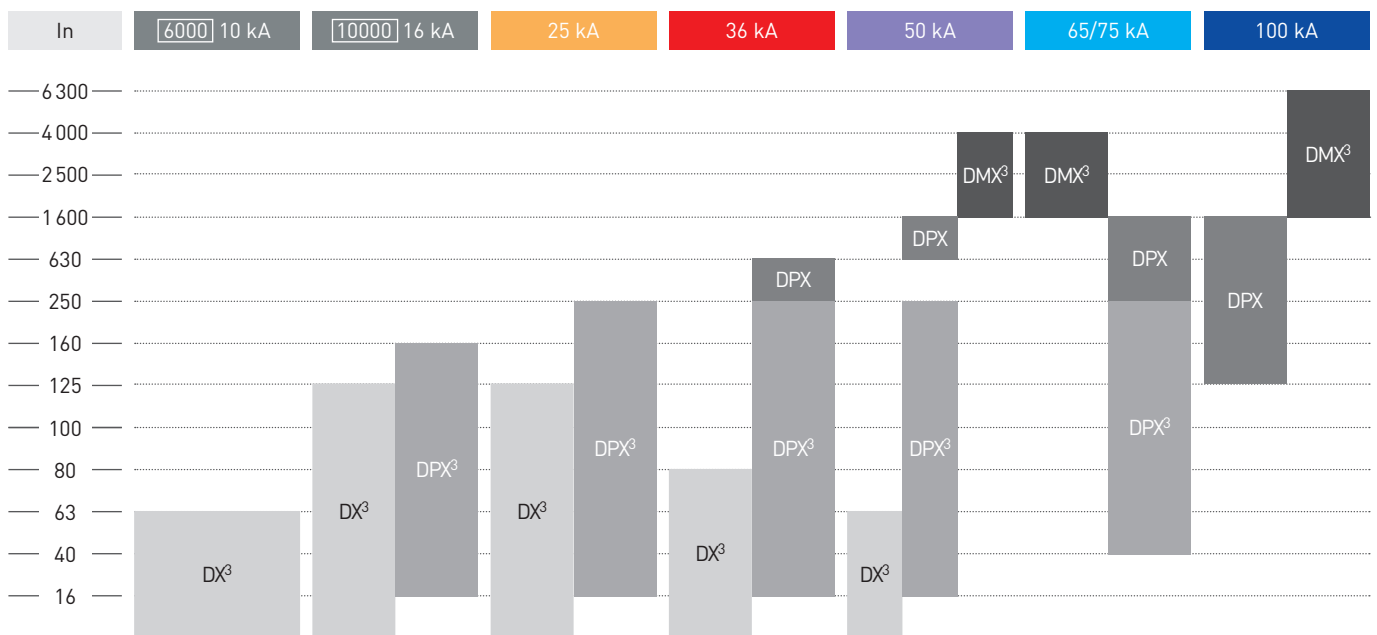
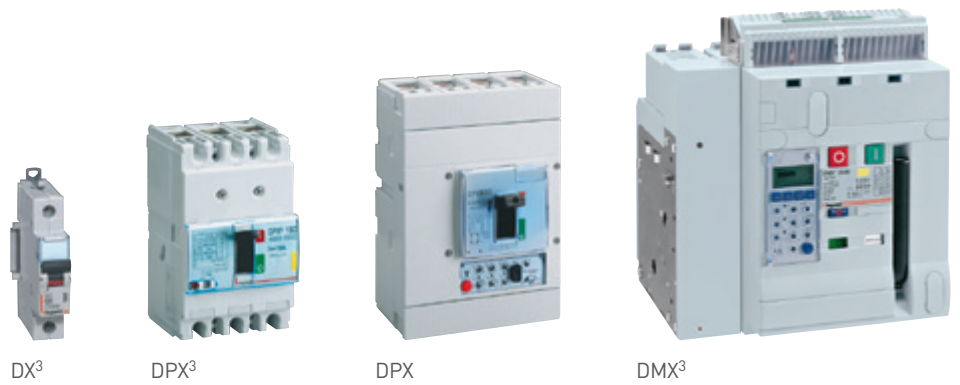

PERFORMANCE THAT MEETS YOUR REQUIREMENTS

The DX³ range is designed to meet the efficiency, safety and compliance requirements with which new electrical installations must comply.

Nominal current, breaking capacity, number of poles, tripping curve, discrimination: the electrical characteristics of the new DX³ circuit breakers have been designed to meet the needs of all types of installations, from residential buildings to the largest industrial sites, including commercial buildings of all sizes.

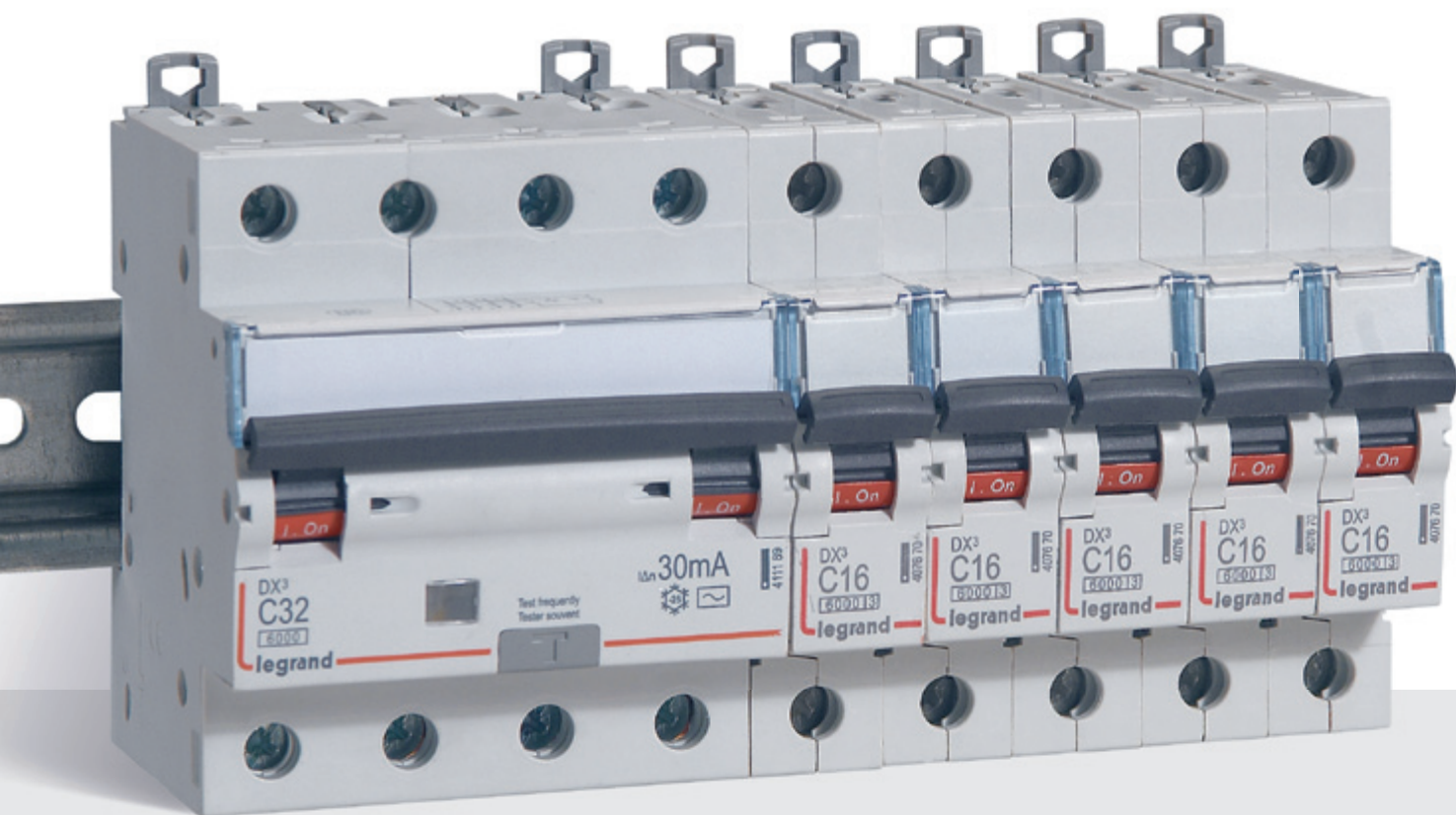

Compact:
10 to 32 A 4-pole DX³ RCBO only 4
modules, protected neutral.

DX³ performance

A comprehensive, uniform range up to 125 A nominal current and 50 kA breaking capacity in a compact unit (1 or 1.5 modules/pole).

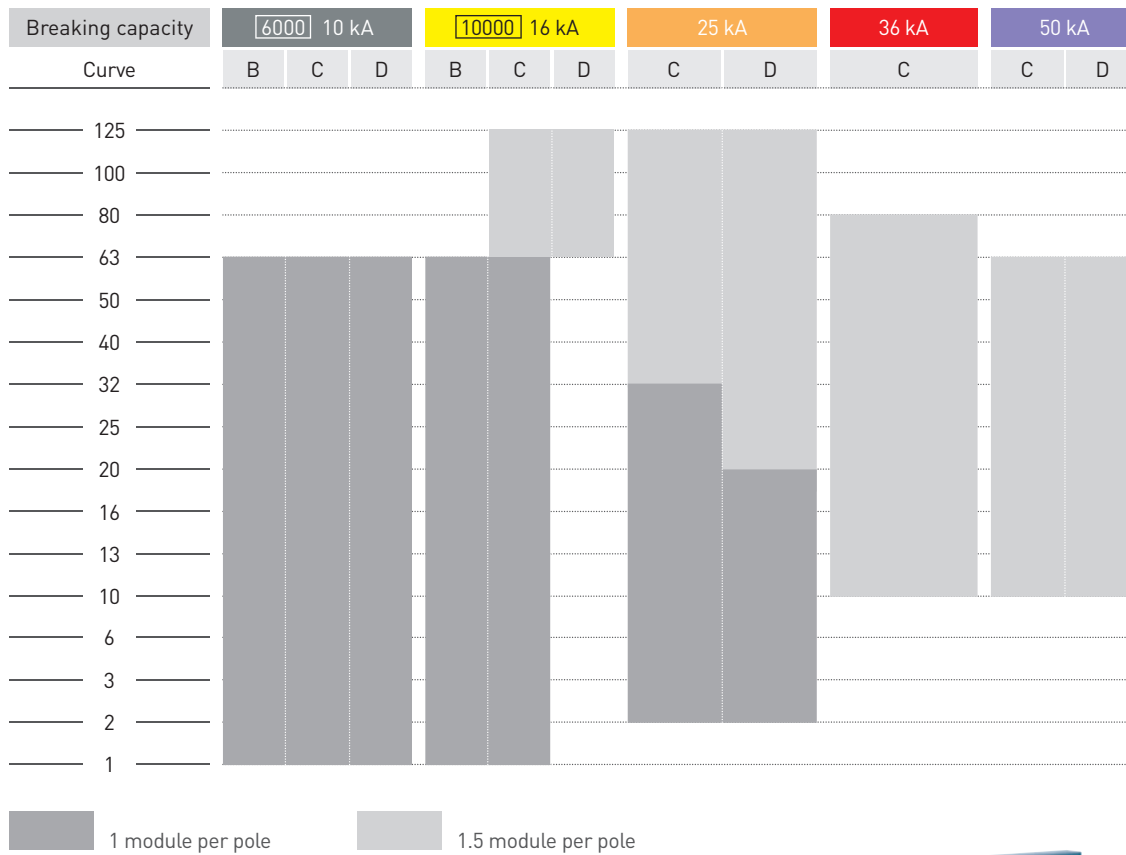

DX³ circuit breakers are limitation class 3: they limit the short-circuit power in the cables and can prolong the installation's life by avoiding damage to the cables resulting from the stresses caused by the power flowing through them. The products never work at the "limit" of their capacity.

The information in the table applies to 1P, 3P and 4P circuit breakers. For further information on the number of modules per pole, please refer to the catalogue pages.



THE XL PRO CALCUL AND XL PRO³ software include the whole DX³ range for building perfect distribution boards.

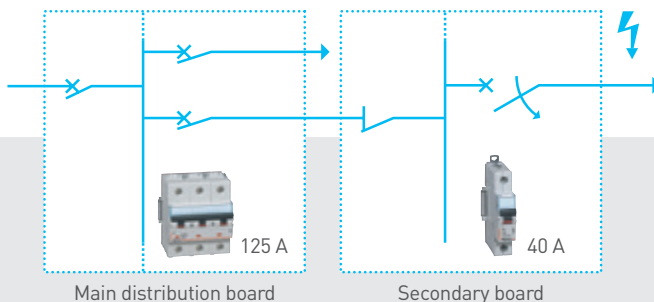

The tripping characteristics are calculated and adjusted to ensure correct discrimination between the different protection levels in order to improve ease of use.

CONTINUITY OF SERVICE: OPTIMUM DISCRIMINATION

The excellent discrimination between DX³ circuit breakers and with DPX or DPX³ MCCBs ensures optimum continuity of service for your installations.

CLEAR IDENTIFICATION OF EACH CIRCUIT



At the head of
distribution boards,
at the head of rows
or to protect outgoing
lines up to 125 A.
There is always a
DX³ solution

Quick identification of devices and circuits is a guarantee of efficiency not only for installation but also for operation and maintenance. Legrand has always taken great care with the marking and ease of identification of its circuit breakers.

The DX³ range includes new enhancements so that your distribution boards are even easier to use.

Technical labelling area

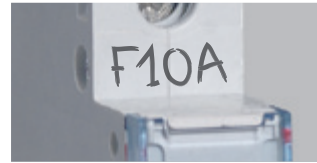

Innovative label-holder:

- Improved opening
- Enhanced dust protection
- Label remains firmly in place during transport



Identification

Dual identification of the breaking capacity and clear marking for easier maintenance

Black handle: circuit breakers
Grey handle: switches

Breaking capacity

- 16 kA ■
- 25 kA ■
- 36 kA ■
- 50 kA ■

Curve

Limitation class 3 (on concerned ratings and breaking capacities)

Rating

Breaking capacity according to IEC 60898-1

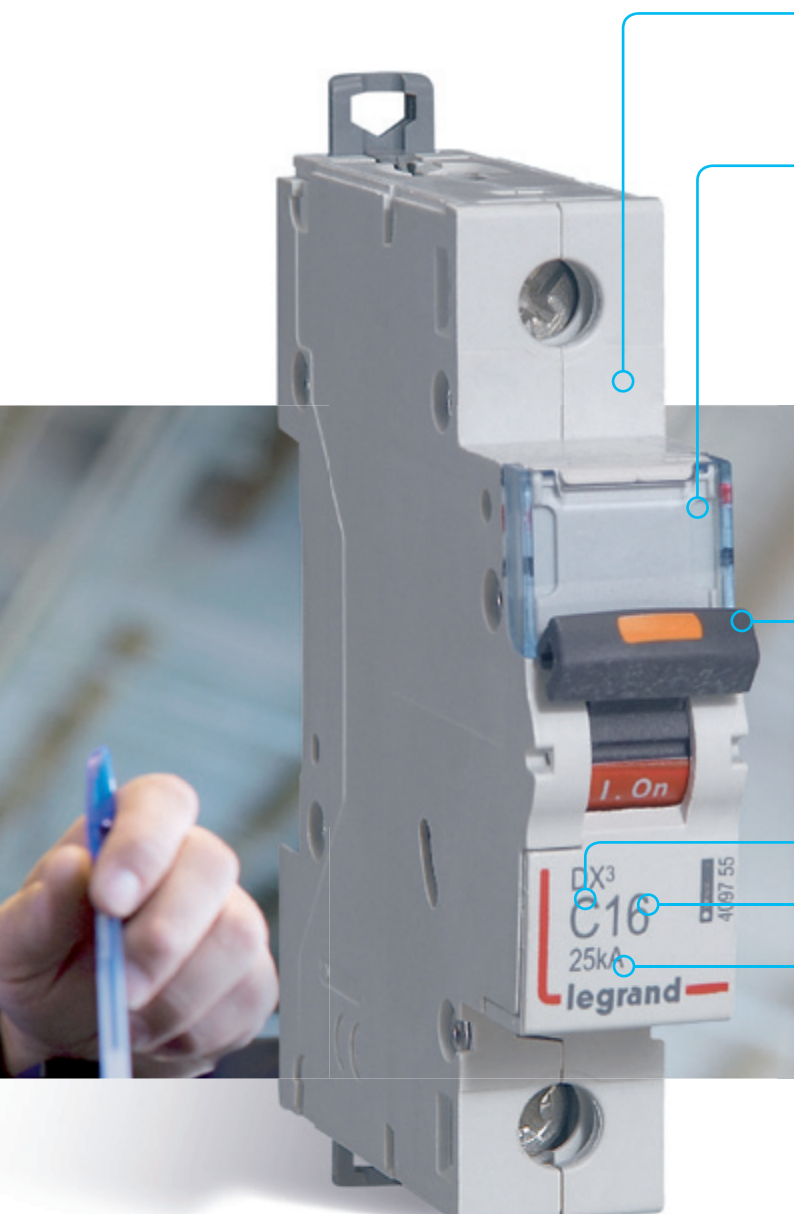

STATE OF THE CIRCUIT BREAKER

Can be identified quickly via the colour marking on the handle:

- I-On/red
- O-Off/green

DX³ IMPECCABLE QUALITY



Legrand pays particular attention to how these devices perform: each of them is set and checked individually on the production lines

Isolating switches, RCDs, circuit breakers, RCBOs, add-on modules, control and signalling auxiliaries: the guarantee of finding the function you need with a uniform appearance and optimised dimensions.



CERTIFICATION OF LEGRAND'S FACTORIES:

- ISO 9001 for quality
- ISO 14001 for environmental protection

DX³ PRODUCTS ARE CERTIFIED IN ACCORDANCE WITH INTERNATIONAL PRODUCT STANDARDS.

Approvals, such as VDE, which are universally recognised for the rigour of their requirements, are renewed annually.

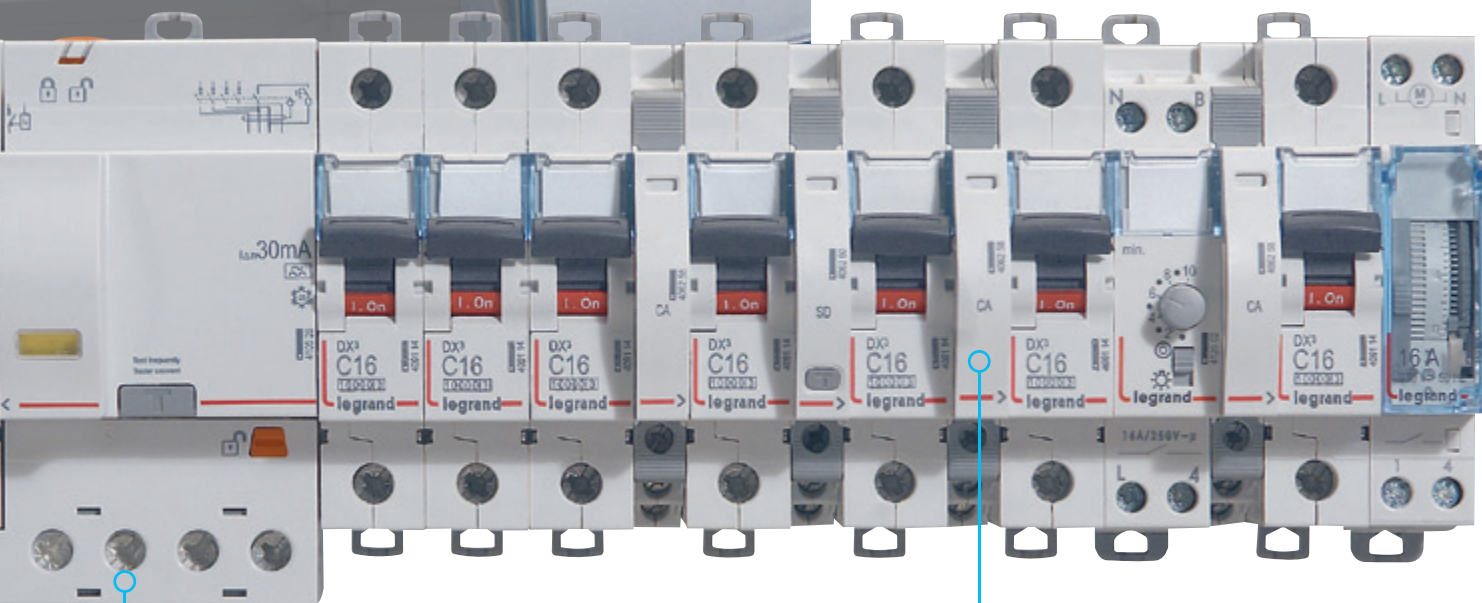

All DX³ circuit breakers can be used with an add-on module (see page 10).

The DX³ control and signalling auxiliaries are common to all the protection devices irrespective of their size (1 or 1.5 modules per pole) (see page 12).



COPYTRACER, THE FIGHT AGAINST COUNTERFEITING

Copytracer is a unique registration number that is marked on some of our products. The number is stored in a database.

Go to the website: www.legrand-copytracer.com

PROTECTION TAILORED TO YOUR REQUIREMENTS

With the
DX³ add-on modules

The new DX³ add-on modules have a wide range of features to meet the most stringent requirements for the protection of people. Like the new DX³ circuit breakers, they offer high performance levels and incorporate innovative solutions for installation and operation.

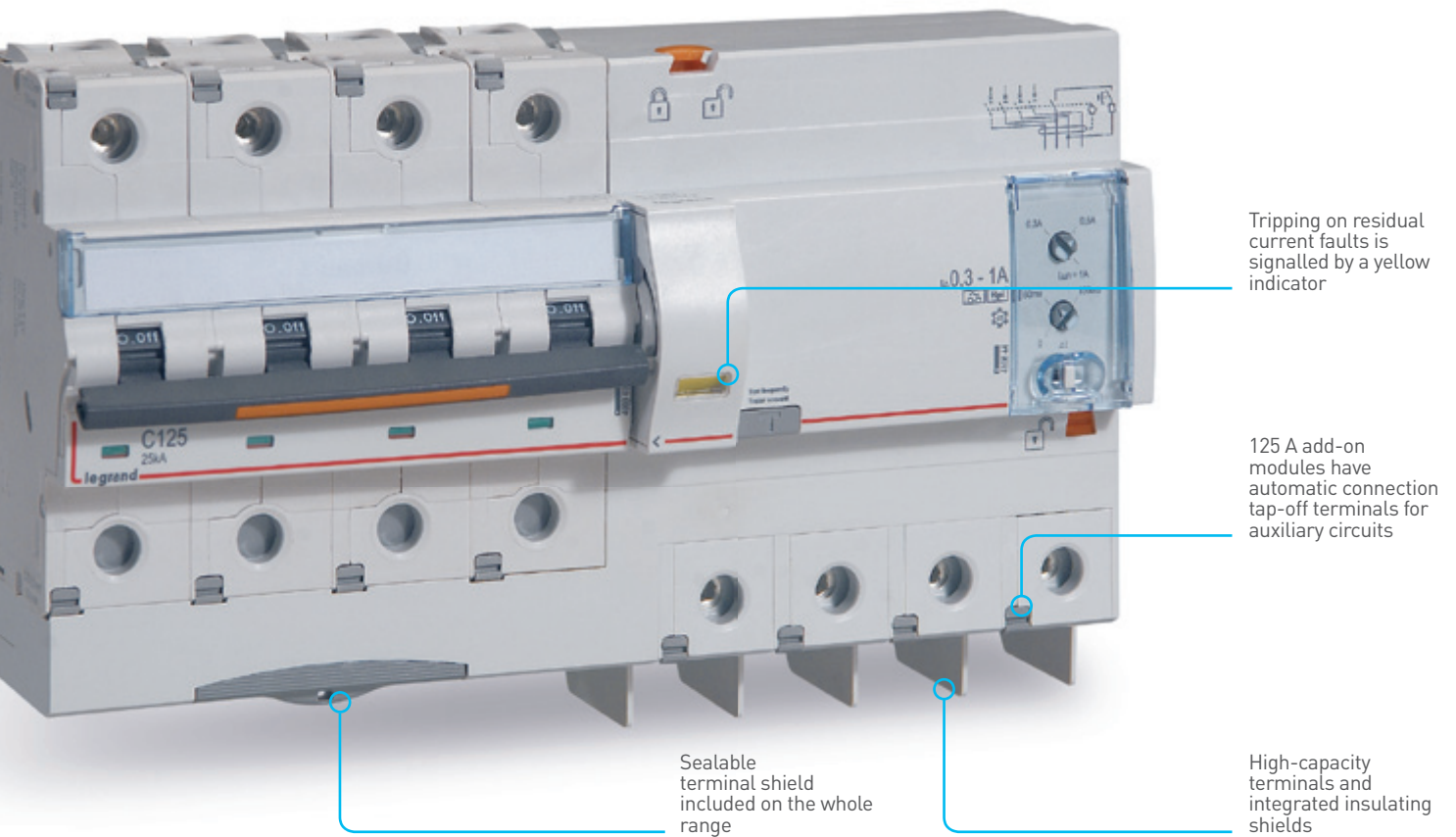

Version		FIXED				ADJUSTABLE	
Sensitivity		30 mA		300 mA		300-500-1000 mA	
Time delay		Instantaneous		Instantaneous		0-60-150 ms	
Max. current		63 A	125 A	63 A	125 A	63 A	125 A
AC type	4P		•		•		
	2P	•	•			•	•
A type Hpi	3P	•	•	•		•	•
	4P	•	•	•		•	•

A single mounting principle for all DX³ add-on modules

It has never been so quick and safe to fit an add-on module.

The exclusive Legrand system, common to the whole DX³ range, makes the assembly extremely strong and provides guaranteed safety.



Maximum continuity of service

DX³ adjustable add-on modules can provide discrimination up to 3 levels by adjusting their sensitivity. They enable those parts of the installation that are not affected by a fault to remain operational, while ensuring total safety of people.

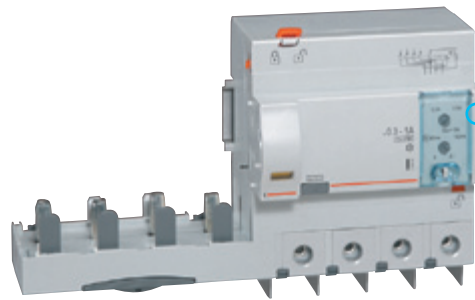

4P - 125 A ADD-ON MODULE adjustable version



Easy to access settings on the front panel with sealable transparent cover

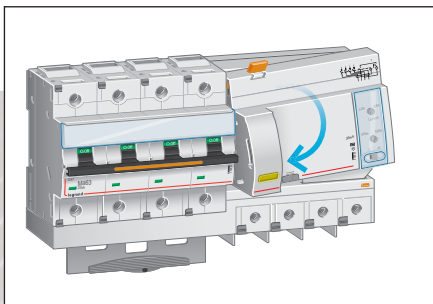

FIT THE CIRCUIT BREAKER and the add-on module

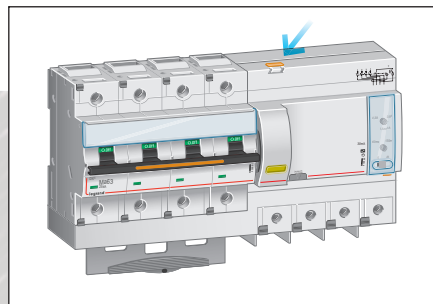

LOCK THE COMBINATION TOGETHER

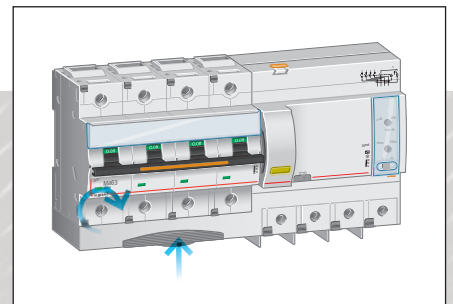

TIGHTEN THE TERMINALS and fit the terminal shield

PERFECT CONTROL OF YOUR INSTALLATION



The DX³ range
has a selection
of electrical
auxiliaries
for monitoring
and controlling
circuits remotely

Auxiliary contacts and fault
signal contacts, shunt trips,
undervoltage releases,
motorised controls and
automatic reclosers

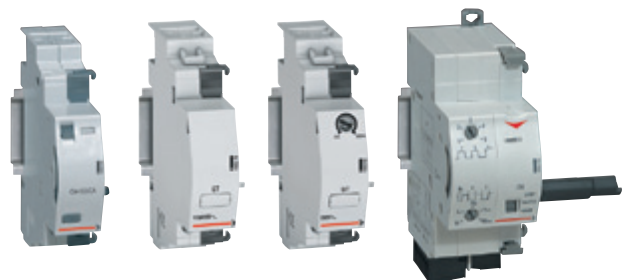

THE AUXILIARIES FIT FIRMLY WITHOUT the need for any tools and ensure the whole assembly is robust

THE ACCESSIBILITY OF THE TERMINALS and the visibility of the screw heads make the installer's work easier

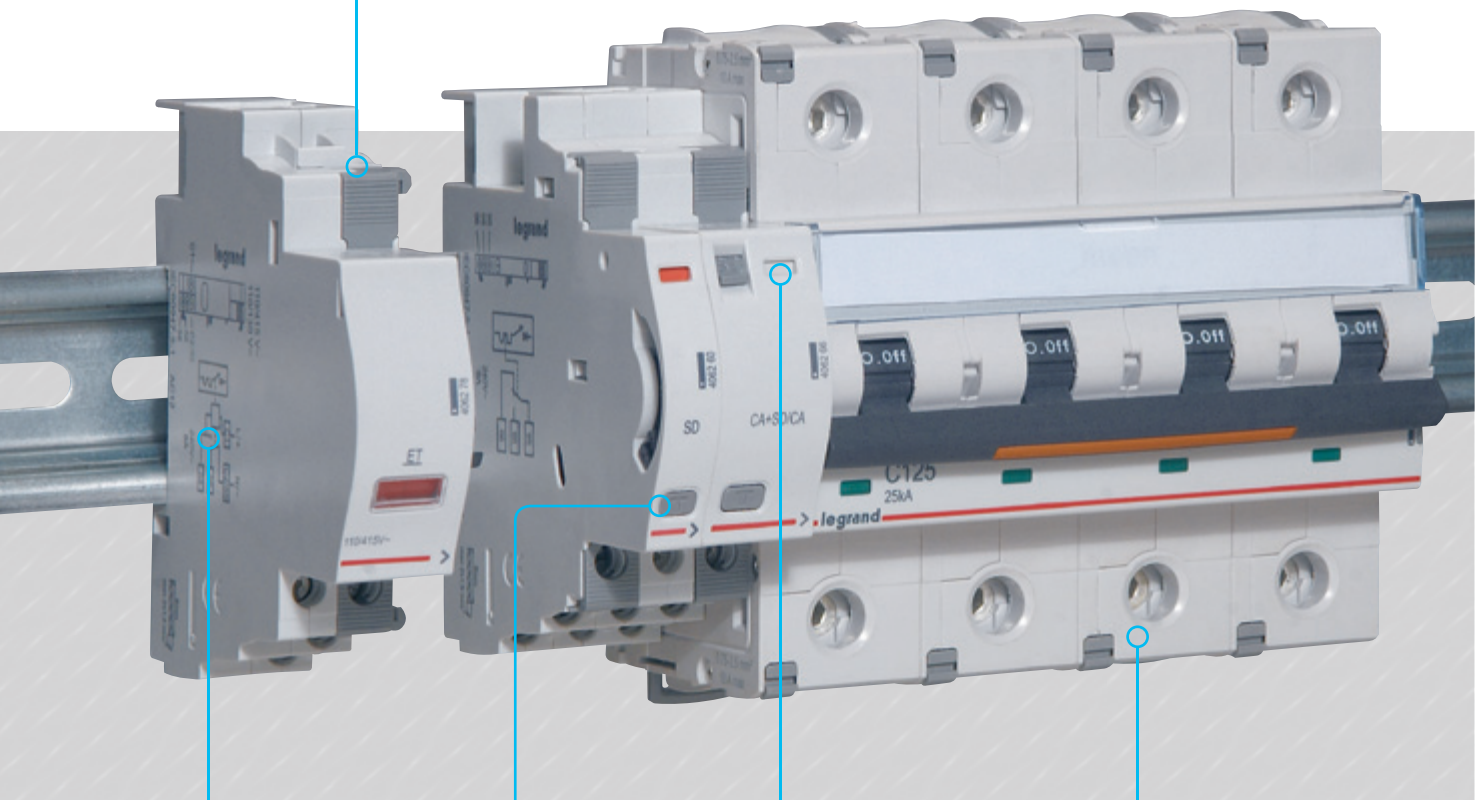
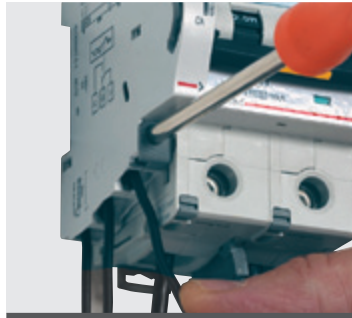
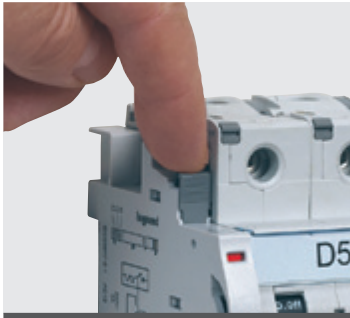

Marking of auxiliaries (characteristics, connection, mounting)

The fault signal contacts have a test button

The colour code of the indicators on the signalling auxiliaries is the same as that of the remote indicators

DX³ circuit breakers take up to 3 auxiliaries including one control auxiliary

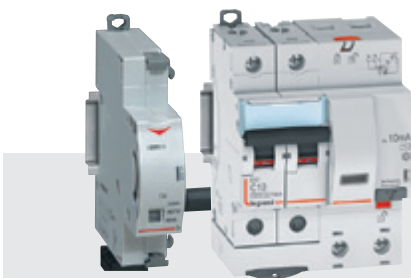

DX³ motorised controls can be used with 1 module per pole devices (circuit breakers, RCBOs and RCCBs) just as easily as auxiliaries.

OPTIMISED SPACE IN THE DISTRIBUTION BOARD

Legrand motorised controls are the most compact on the market: 1 module wide. They save a great deal of space inside the distribution board.

EASY, SAFE CONNECTION



Safety is prioritised with the innovative features of the DX³ products

The quality and hold of the connections are vital for the safety of distribution boards. This is why Legrand, with its wealth of experience and expertise, has broken new ground again with terminals with a loosening compensation system and retractable insulating shields.



1 MODULE/POLE
Terminal capacity :
In ≤ 63 A → 35 mm²



1,5 MODULES/POLE
Terminal capacity :
In ≤ 63 A → 50 mm²
In ≥ 80 A → 70 mm²

WIRE GUIDE FLAP
ensures the wire is in the correct position

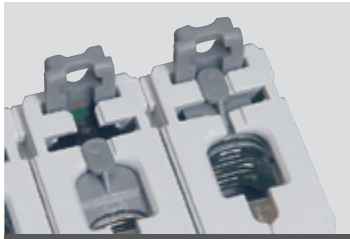

RISING CLAMP TERMINALS
ensure a high quality, durable connection

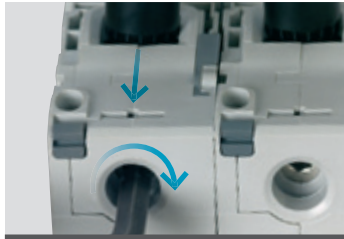

RELIABLE CONNECTIONS
Compensation for the effect of loosening to ensure excellent hold over time and consistent contact ($I_n \geq 80 \text{ A}$)

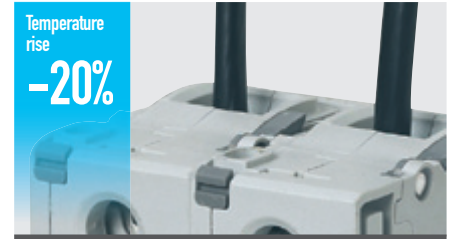

Clamping screw for flat or pozidrive screwdriver. Tightening torques higher than those recommended by the standard



The use of an Allen key makes it easier to tighten to the required torque ($I_n \geq 80 \text{ A}$)



RETRACTABLE INSULATING SHIELDS

With the integrated retractable insulating shields, no additional accessories are needed to isolate the connections on all breaking capacities and high ratings of the 1.5 modules/pole ($I_n \leq 63 \text{ A}$) circuit breakers.

CHOOSE YOUR DISTRIBUTION

A wide range of distribution devices is available for your modular rows

From the simple supply busbar to the HX³ 125 A plug-in distribution block, whether they have conventional screw connections or more innovative automatic terminal connections, or plug in directly, Legrand quality is always there.

STANDARD DISTRIBUTION Supply busbars

DX³ 1 module/pole devices up to 63 A can be connected to supply busbars via the top or the bottom.

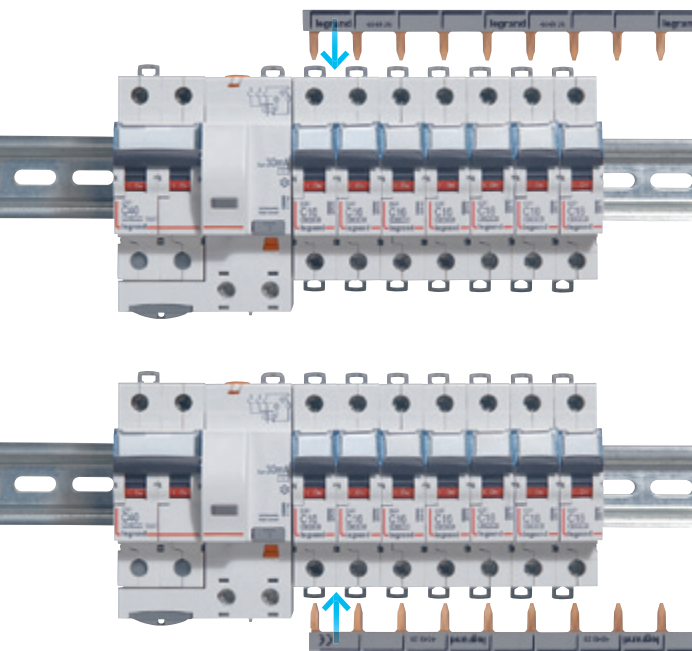

Four-pole distribution

For three-phase horizontal distribution in a single action.

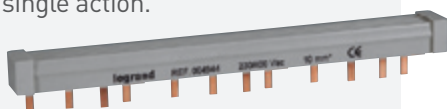

STANDARD DISTRIBUTION Modular distribution blocks

The 40 to 250 A modular distribution blocks are totally universal, making them suitable for all types of distribution board.

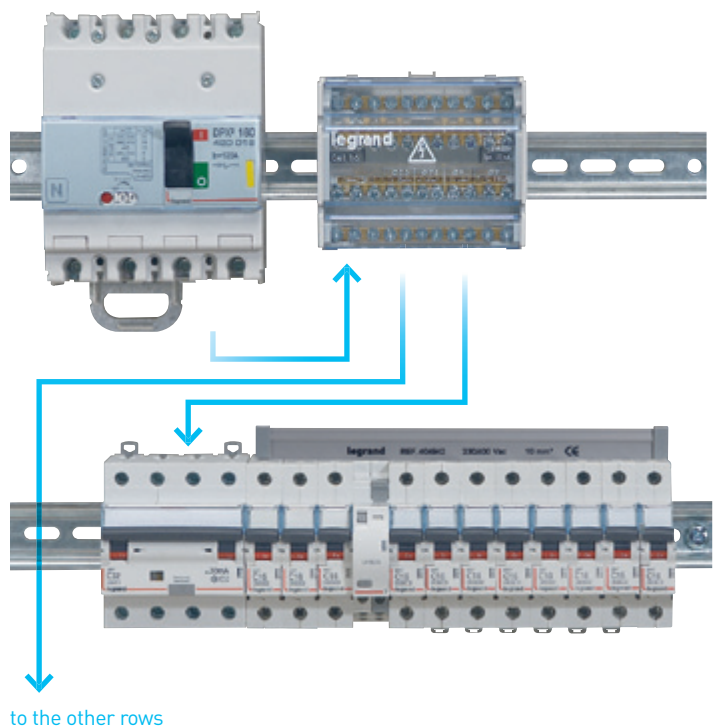

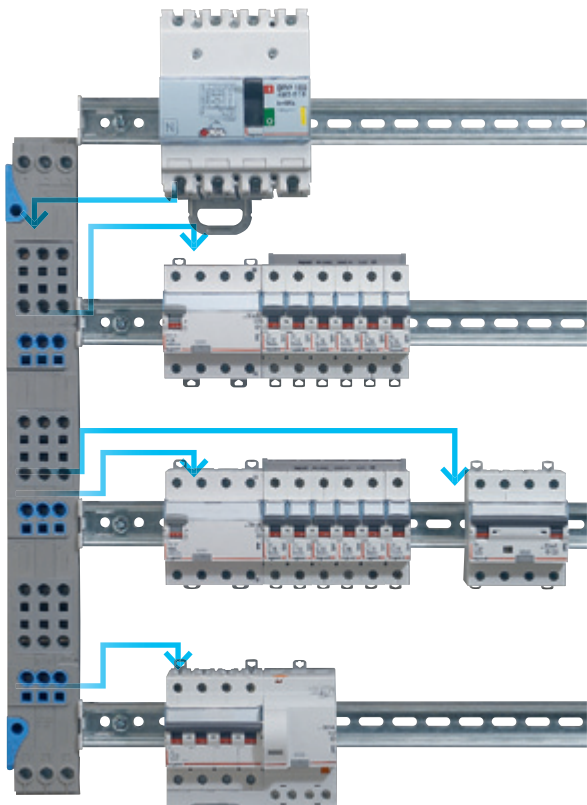

OPTIMISED DISTRIBUTION VX³ 63 and 125 A, vertical distribution blocks with automatic terminals

- Significant space saving due to their vertical installation beside the rows
- Time saving as there is less wiring with the IP 2x automatic terminals for flexible or rigid wires.



Mounting in Legrand enclosures:
Plexo³, XL³125, 160, 3 to 6 rows

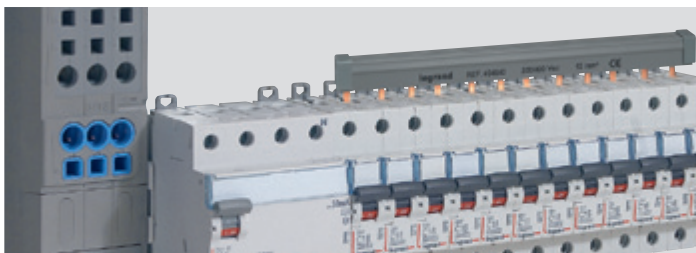

SUPPLY BUSBARS, AN IDEAL ADDITION

In addition to 4-pole vertical distribution blocks with automatic terminals, supply busbars power the devices in each row via the "head of row" protection device.

CHOOSE YOUR DISTRIBUTION (continued)

Legrand optimised distribution has been designed for maximum safety and for ease of installation and maintenance of distribution boards

Wiring and tedious tightening operations are minimised, and the risks of poor contact and short-circuits are reduced while mounting time is optimised.

OPTIMISED DISTRIBUTION HX³ 125 A horizontal distribution blocks with automatic terminals

Horizontal 4-pole distribution for
XL³ 160 to 4000 enclosures:

- Freedom to mix 1P, 1P+N, 2P, 3P and 4P devices on the same row
- Space saving: installed between the rows
- Time saving: less wiring, IP 2x automatic terminals for flexible or rigid wires

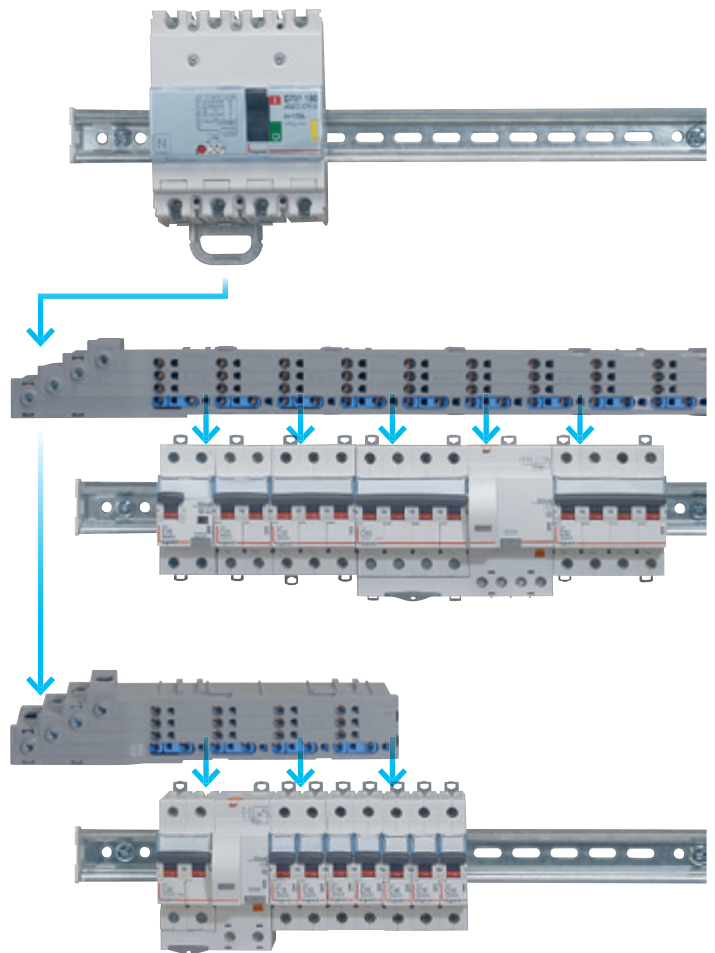

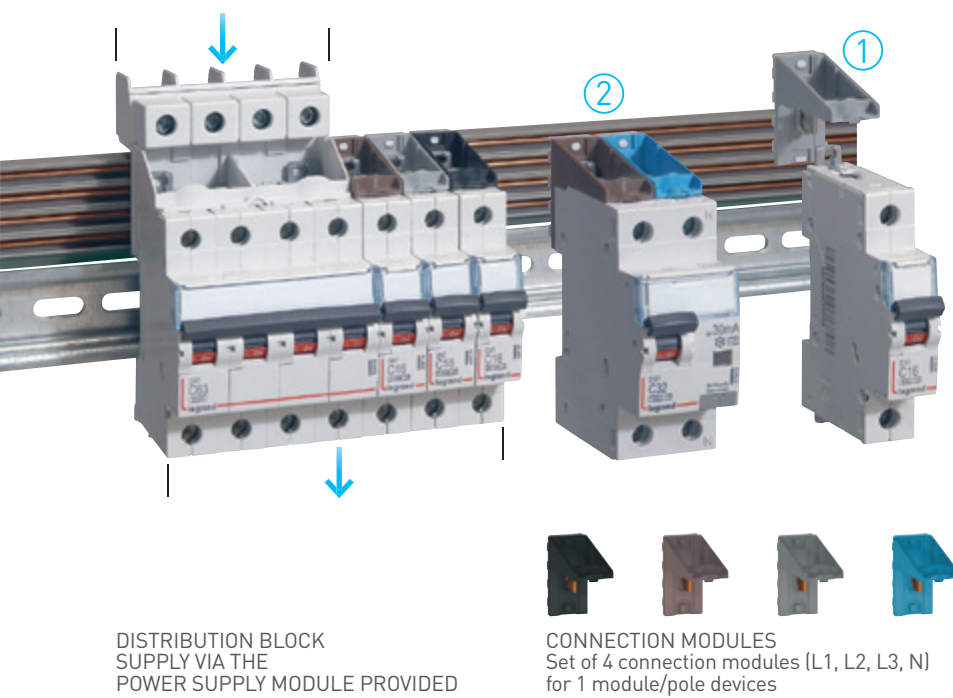

OPTIMISED DISTRIBUTION HX³ 125 A horizontal distribution blocks with plug-in connection

Horizontal 4-pole distribution for XL³ 160 to 4000 enclosures:

- Optimised design: freedom to mix 1P, 1P+N, 2P, 3P and 4P devices on the same row
- Optimised installation: automatic connection with no wiring or clamping
- Safe connection and disconnection of devices, even when the distribution block is powered-up (due to the IP xxB insulation of the distribution block and the integral connection modules in the devices).



CONNECTION MODULES
Set of 4 connection modules (L1, L2, L3, N)
for 1 module/pole devices

DISTRIBUTION BLOCK
SUPPLY VIA THE
POWER SUPPLY MODULE PROVIDED

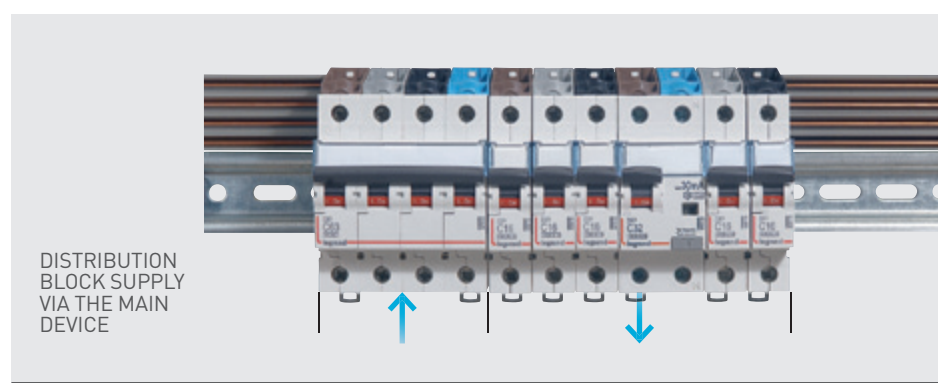

DISTRIBUTION BLOCK
SUPPLY
VIA THE MAIN
DEVICE

EASY CONNECTION

Circuit breakers with plug-in terminals are fixed onto the distribution block with no need for any tool. The phase to be connected is determined by the choice of connector. The distribution block can be supplied via the power supply module provided or via the head of row device.

EASY OPERATION AND MAINTENANCE

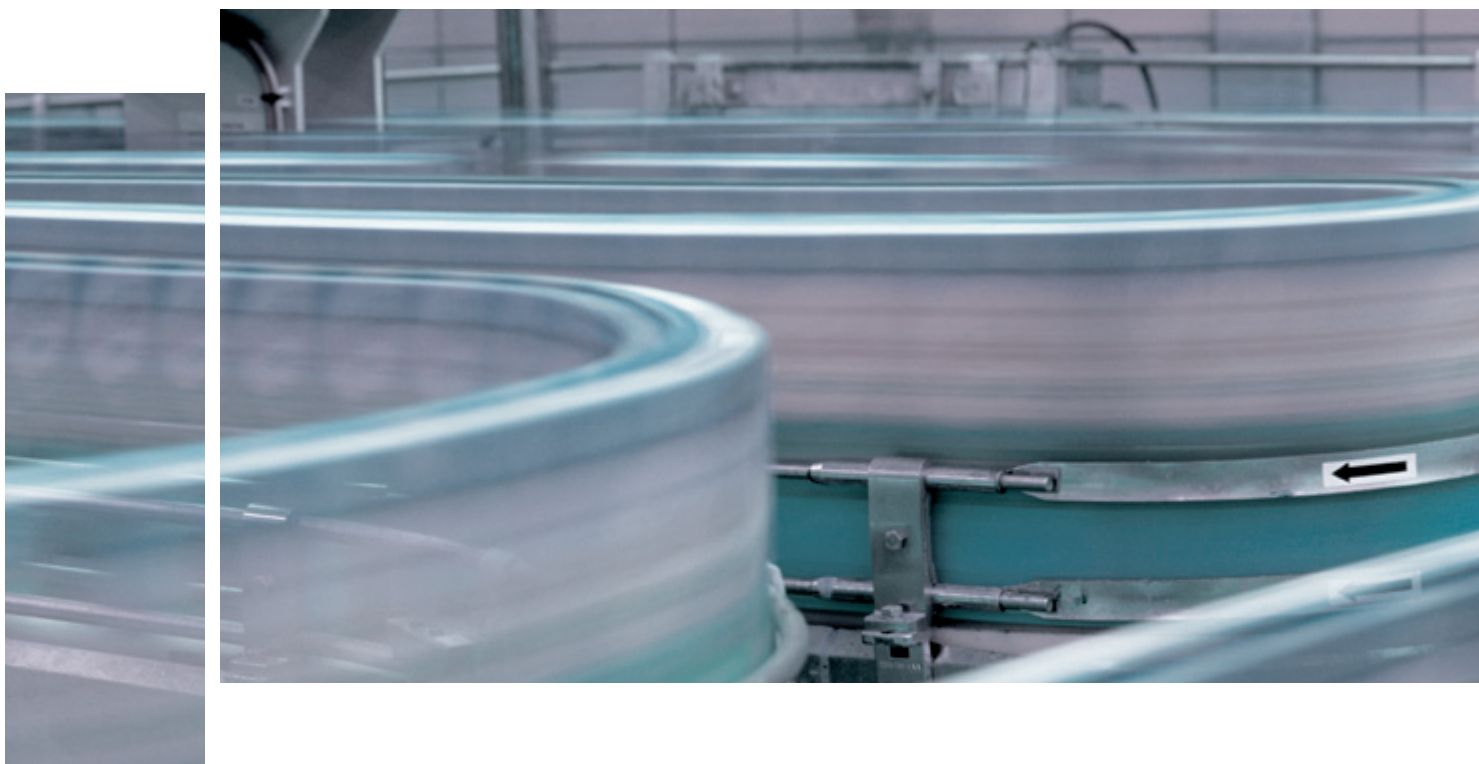

When designing
the DX³ range,
Legrand did not
forget about
users and
maintenance
engineers

As well as the already well-known functions such as the double clip which enables maintenance to be carried out on the module, new features such as the labelling area, automatic connection tap-off terminals and status indicators have been added to make day-to-day use of distribution boards even easier.

EASY TAP-OFF CONNECTION FROM 80 A
 The IP 2x automatic tap-off terminals can be used to connect an auxiliary circuit or a measuring device safely



INCREASED SAFETY
 The DX³ range guarantees IP2x protection. There is no risk of contact with live parts, even when the faceplate is open.

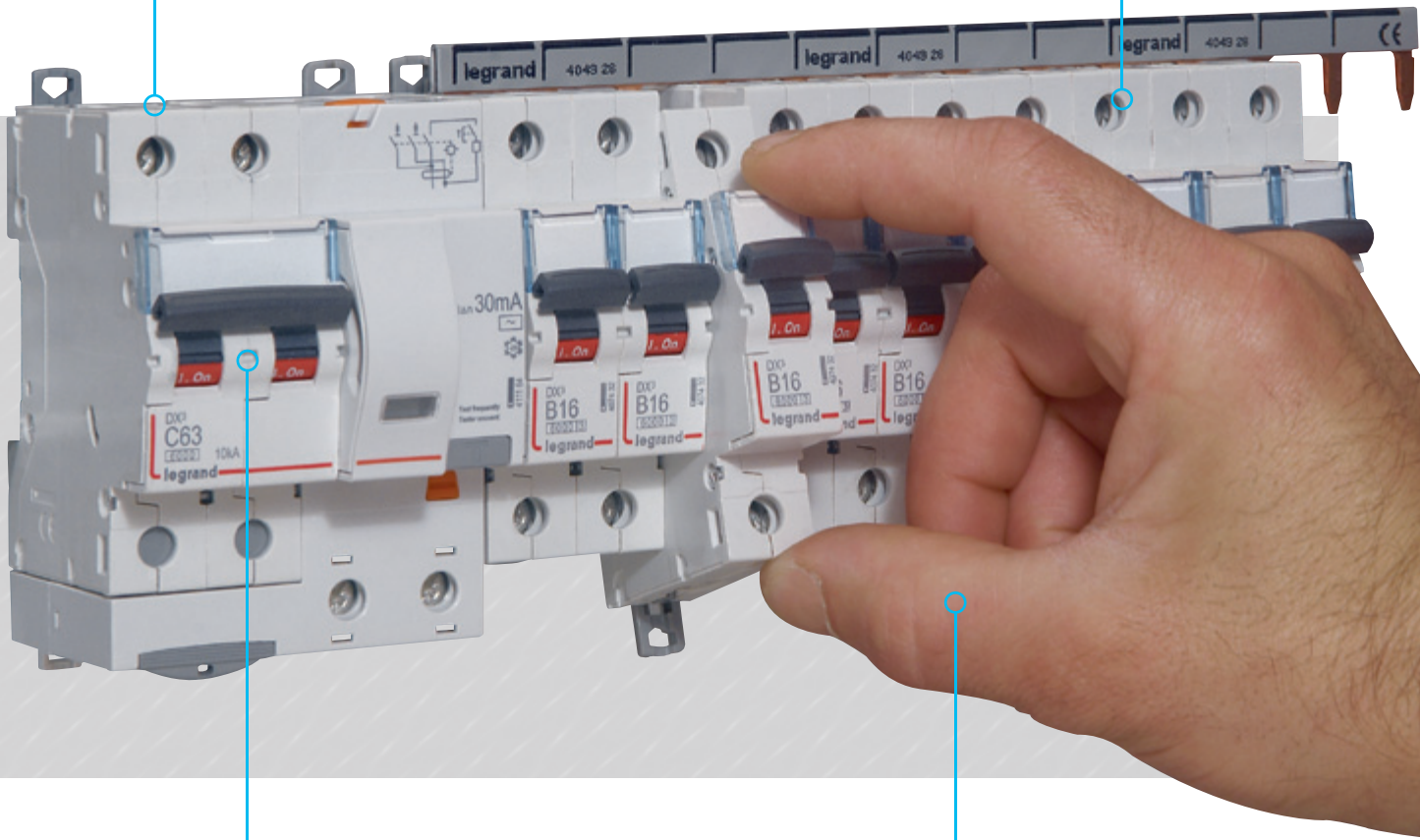

LOCKING IN OPEN POSITION
 for 1.5 module per pole devices using a single Colring cable tie

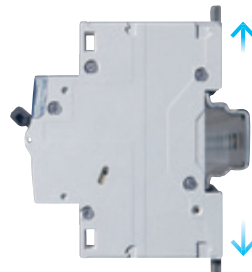

THE DOUBLE CLIP
 enables a device to be replaced without disconnecting the whole row

MORE COMFORTABLE BUILDINGS AND ENERGY SAVINGS

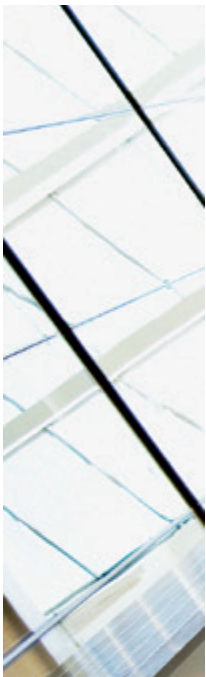

The Legrand modular control and monitoring devices are a perfect addition to the range of DX³ protection devices

With the same design, they integrate perfectly in your distribution boards. Power contactors, pulse operated latching relays, pushbuttons, indicators, timers, programmers, etc. With the selection of functions available it is simple to improve the safety, efficiency and comfort of installations and meet energy requirements.



SUPPLY BUSBAR INSERTION

There is a position on the top of the control devices for inserting the supply busbar

LIGHT SENSITIVE SWITCH to switch lighting on automatically when the natural light decreases

16 A TO 63 A LEGRAND POWER CONTACTORS are available with 24 VAC or 230 VAC coil

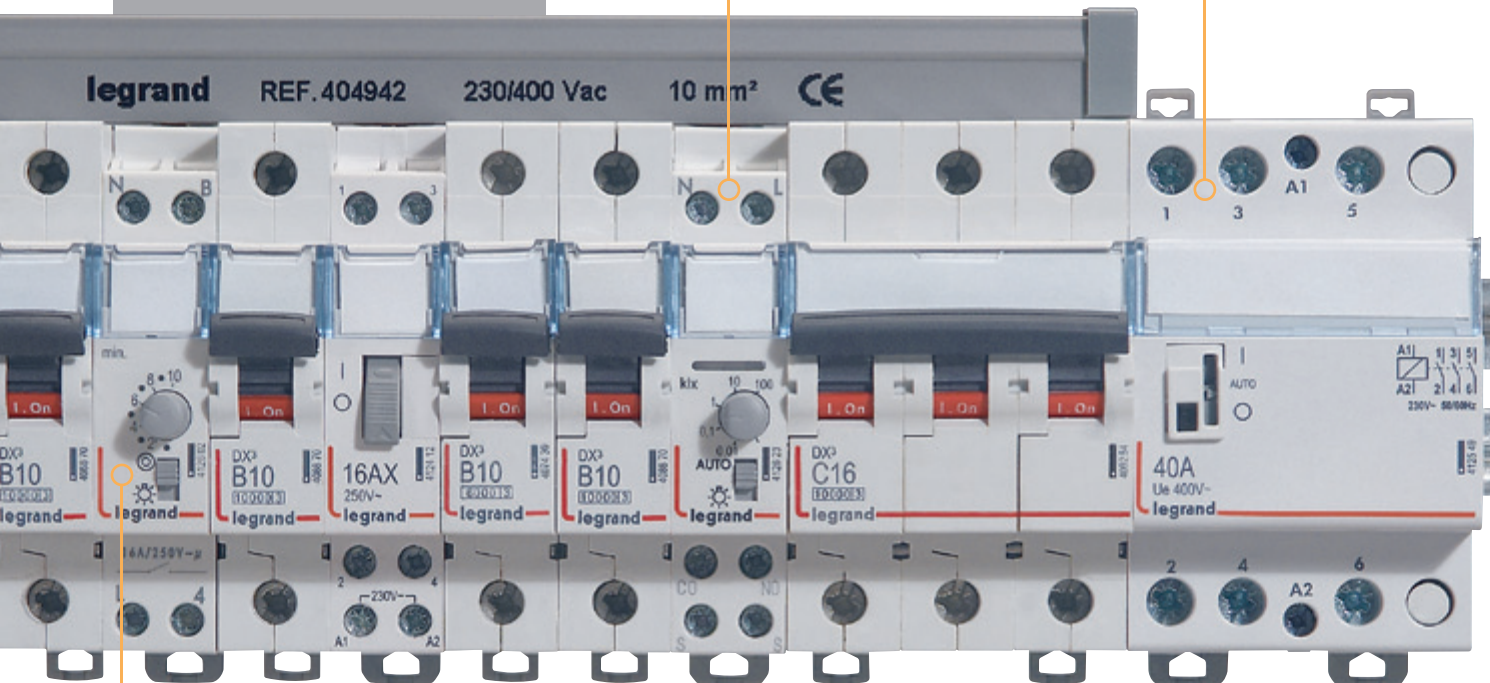

TIMER to switch off of lighting automatically after an adjustable period of 0.5 s to 10 min



- 1 to 4 x 16 A outputs
- 24-hour, 7-day or annual programming
- Programming direct or from a PC with a transfer key

ENERGY SAVINGS WITH TIMERS

In order to optimise power consumption, Legrand electronic timers can be used to assign operating periods, for example for heating or lighting.

MEASUREMENT AT THE HEART OF ENERGY EFFICIENCY

A project to optimise
quality and 
energy efficiency must
include measurement

Measurement upstream, to identify the critical points and ensure optimum targeting of the actions to be taken. Downstream to monitor the effects and control any drift. Legrand EMDX³ measurement control units and electricity meters will naturally have a place in distribution boards.

EMDX³ measurement control units

All the essential parameters of
the installation on DIN rail or on the door :

- Dual tariff metering
- Active and reactive energy
- Operating time
- Power factor
- Harmonic distortion
- Programmable alarms



EMDX³ UNIT ON DIN RAIL



EMDX³ UNIT ON DOOR
EMDX³ units on doors provide a large size display and their capacity can be increased with extension modules.



ECO-DESIGN A VOLUNTARY APPROACH

The Legrand group has been taking environmental problems into account since 2001. This approach is based on international standards for the objective measurement of the environmental impacts of products in terms of both consumption of resources and pollution. Legrand publishes these reports in the form of PEP (Product Environmental Profile) sheets.

Remote supervision and viewing

With the Legrand communication interfaces (RS 485, IP), supervision software and Web servers, measurements can be centralised and displayed remotely on a PC, tablet or smartphone.



DISPLAY OF 32 MEASUREMENT POINTS
ON TABLET COMPUTERS AND WEB SERVERS

EMDX³ electricity meter on DIN rail

EMDX³ meters installed in secondary distribution boards can be used to monitor consumption per building, per floor and per application.





DIN RAIL equipment

RCDs and RCBOs



P. 28
DX³-ID
2-pole RCDs
from 16 to 100 A

MCBs



P. 32
DX³ 6000 - 10 kA
MCBs from 1 to 63 A

Add-on modules



P. 38
DX³ 2-pole
add-on modules
for 1 module/pole
MCBs

Auxiliaires, remote control and accessories



P. 40
Signalling
auxiliaires

Other control functions



P. 49
CX³
power
contactors

EMDX³ electrical energy meters & measuring units



P. 58
EMDX³
electrical energy
meters

DISCOVER THE PRODUCTS



DX³ - ID
RCDs
(p. 28)

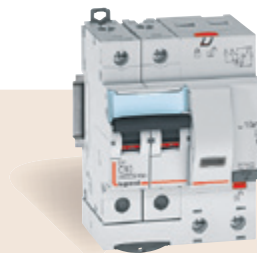

DX³
RCBOs
(p. 30)



P. 28
DX³-ID
4-pole RCDs
from 25 to 100 A



P. 30
DX³ 10000
single pole RCBOs
from 10 to 45 A



P. 30
DX³ 6000 - 10 kA
single pole + neutral
RCBOs
from 3 to 63 A



P. 31
DX³ 6000 - 10 kA
2 and 4-pole
RCBOs
from 10 to 63 A



P. 34
DX³ 10000 - 16 kA
MCBs from 1 to 125 A



P. 36
DX³ 25 kA
MCBs
from 2 to 125 A



P. 37
DX³ 36 kA
MCBs
from 10 to 80 A



P. 37
DX³ 50 kA
MCBs
from 10 to 63 A



P. 38
DX³ 3-pole
add-on modules
for 1 module/pole
MCBs



P. 38
DX³ 4-pole
add-on modules
for 1 module/pole
MCBs



P. 39
DX³ 2 and 4-pole
add-on modules
for 1.5 modules/pole
MCBs



P. 40
Current shunt trips
and undervoltage
releases



P. 40
Motorised
controls



P. 41
STOP&GO
automatic
resetting



P. 52
Pulse operated
latching relays



P. 54
Programmable
time switches



P. 56
Electronic
time-lag
switches



P. 57
Light sensitive
switches



P. 58
EMDX³
DIN rail mounting
multi-function
measuring units



P. 59
EMDX³
door mounting
multi-function
measuring units



P. 60
Current
transformers

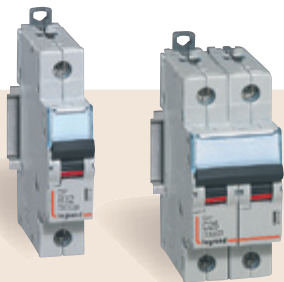

DX³
MCBs
(p. 32)



EMDX³
multi-function
measuring units
(p. 59)

RCDs - DX³-ID

residual current devices 16 A to 100 A - AC, A and Hpi types



4 115 25



4 117 05



4 117 60

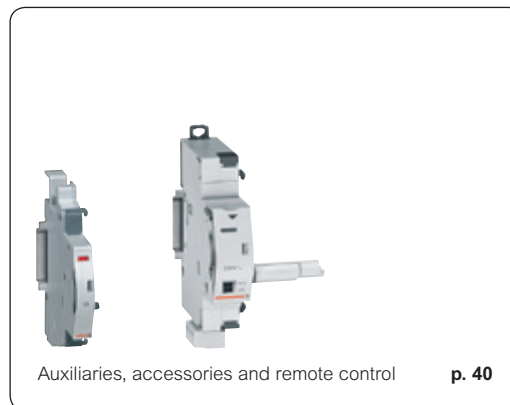

Auxiliaries, accessories and remote control

p. 40

Dimensions **see e-catalogue**
 Technical characteristics **p. 29**

Conform to IEC 61008 - 1

- AC type : detect AC component faults
 - A type : detect AC and DC component faults
 - Hpi type (High immunity) : detect AC and DC component faults
- Enhanced immunity to unwanted tripping in disturbed environments
 Can be equipped with DX³ auxiliaries and accessories (p. 40)

Pack	Cat.Nos	2-pole - 230 V \sim	Number of modules
		AC Type 10 mA	
		Nominal rating In (A)	
1	4 115 00	16	2
		AC Type 30 mA	
1	4 115 04	25	2
1	4 115 05	40	2
1	4 115 06	63	2
1	4 115 07	80	2
1	4 115 08	100	2
		AC Type 100 mA	
1	4 115 14	25	2
1	4 115 15	40	2
1	4 115 16	63	2
1	4 115 17	80	2
		AC Type 300 mA	
1	4 115 24	25	2
1	4 115 25	40	2
1	4 115 26	63	2
1	4 115 27	80	2
1	4 115 28	100	2
		AC Type 100 mA selective	
1	4 115 37	100	2
		AC Type 300 mA selective	
1	4 115 43	63	2
		A Type 10 mA	
1	4 115 50	16	2
		A Type 30 mA	
1	4 115 54	25	2
1	4 115 55	40	2
1	4 115 56	63	2
1	4 115 57	80	2
		A Type 300 mA	
1	4 115 69	25	2
1	4 115 70	40	2
1	4 115 71	63	2
1	4 115 72	80	2
		Hpi Type 30 mA	
1	4 115 90	25	2
1	4 115 91	40	2
1	4 115 92	63	2

Pack	Cat.Nos	4-pole - 400 V \sim - neutral on right-hand side	Number of modules
		AC Type 30 mA	
		Nominal rating In (A)	
1	4 117 02	25	4
1	4 117 03	40	4
1	4 117 04	63	4
1	4 117 05	80	4
		AC Type 100 mA	
1	4 117 12	25	4
1	4 117 13	40	4
1	4 117 14	63	4
1	4 117 15	80	4
		AC Type 300 mA	
1	4 117 22	25	4
1	4 117 23	40	4
1	4 117 24	63	4
1	4 117 25	80	4
		AC Type 500 mA	
1	4 117 32	25	4
1	4 117 33	40	4
1	4 117 34	63	4
1	4 117 35	80	4
		AC Type 300 mA selective	
1	4 117 45	40	4
1	4 117 46	63	4
		A Type 30 mA	
1	4 117 59	25	4
1	4 117 60	40	4
1	4 117 61	63	4
1	4 117 62	80	4
1	4 117 63	100	4
		A Type 100 mA	
1	4 117 69	25	4
1	4 117 70	40	4
1	4 117 71	63	4
1	4 117 72	80	4
1	4 117 73	100	4
		A Type 300 mA	
1	4 117 79	25	4
1	4 117 80	40	4
1	4 117 81	63	4
1	4 117 82	80	4
1	4 117 83	100	4

RCDs - DX³-ID - residual current devices

16 A to 100 A - AC, A and Hpi types (continued)



4 117 90

Dimensions **see e-catalogue**

Conform to IEC 61008 - 1

- AC type : detect AC component faults
 - A type : detect AC and DC component faults
 - Hpi type (High immunity) : detect AC and DC component faults
- Enhanced immunity to unwanted tripping in disturbed environments
Can be equipped with DX³ auxiliaries and accessories (p. 40)

Pack	Cat.Nos	4-pole - 400 V [~] - neutral on right-hand side (continued)	
		Nominal rating I _n (A)	Number of modules
		A Type 500 mA	
1	4 117 89	25	4
1	4 117 90	40	4
1	4 117 91	63	4
1	4 117 92	80	4
1	4 117 93	100	4
		A Type 300 mA selective	
1	4 118 00	40	4
1	4 118 01	63	4

For detailed dimensions, **see e-catalogue**



RCDs DX³-ID

technical characteristics

DX³-ID - RCDs (residual current devices)

Connection cross-section

RCDs	Cable (mm ²)	
	rigid	flexible
Connection at top and bottom	50	35

AC type - Standard applications

AC type RCDs detect AC residual currents
In the majority of cases (standard applications), they are used for AC current detection at 50/60 Hz

A type - Specific applications: dedicated lines

In addition to the characteristics of AC type RCDs, A type RCDs also detect DC residual currents
They are used whenever fault currents are not sinusoidal
They are particularly suitable for the following specific applications (hobs, washing machines...) or materials that may produce DC fault currents, speed drives with frequency inverters, etc.

Hpi type - Special applications

Type Hpi RCDs are devices which offer additional immunity to unwanted tripping which significantly exceeds the level required by the standard
They are also able to detect AC and DC residual currents (A type)
Operation between - 25 °C and + 40 °C
They are used in special applications where:

- Loss of information is potentially damaging, e.g. power supply lines for computer equipment (banks, equipment on military bases, flight reservation centres, etc.)
- Loss of operation is potentially damaging (automated machinery, medical equipment, freezer cable, etc.)

They are also used:

- On sites where there is an increased risk of lightning strikes
- On sites where cables are subject to high levels of interference (use of fluorescents, etc.)
- On sites where very long cables are used

RCBOs DX™ **10000** - residual current circuit breakers from 10 A to 45 A AC type



6 064 15

Dimensions **see e-catalogue**
Technical characteristics **p. 42**

Breaking capacity:

10000 - IEC 61009-1 - for single pole

• AC type : detect AC component faults

Pack	Cat.Nos	Single pole - 230 V _~
		Blue neutral leads
		AC Type 30 mA
		C curve
		Nominal rating In (A)
1	6 064 10	10
1	6 064 11	16
1	6 064 12	20
1	6 064 13	25
1	6 064 14	32
1	6 064 15	45

Number of modules

1
1
1
1
1
1
1

RCBOs DX³ **6000** - 10 kA - residual current circuit breakers from 3 A to 63 A AC, A and Hpi types



4 110 02

Dimensions **see e-catalogue**
Technical characteristics **p. 42**

Conform to IEC 61009-1

Breaking capacity:

6000 - IEC 61009-1 - 10 kA / IEC 60947-2 for single pole + neutral, 2 and 4-pole

- AC type : detect AC component faults
 - A type : detect AC and DC component faults
 - Hpi type (High immunity) **Hpi**: detect AC and DC component faults
- Enhanced immunity to unwanted tripping in disturbed environments
Can be equipped with DX³ auxiliaries and accessories (p. 40)

Pack	Cat.Nos	Single pole + neutral - 230 V _~	
		Neutral on right-hand side	
		AC Type 10 mA	
		Nominal rating In (A)	
		Number of modules	
1	C curve 4 109 93	16	2
		AC Type 30 mA	
1	4 109 97	3	2
1	4 109 99	6	2
1	4 110 00	10	2
1	4 110 02	16	2
1	4 110 03	20	2
1	4 110 04	25	2
1	4 110 05	32	2
1	4 110 06	40	2
		AC Type 300 mA	
1	4 110 21	6	2
1	4 110 22	10	2
1	4 110 24	16	2
1	4 110 25	20	2
1	4 110 26	25	2
1	4 110 27	32	2
1	4 110 28	40	2
		A Type 10 mA	
1	4 110 41	16	2
		A Type 30 mA	
1	4 110 47	6	2
1	4 110 48	10	2
1	4 110 50	16	2
1	4 110 51	20	2
1	4 110 52	25	2
1	4 110 53	32	2
1	4 110 54	40	2
		Hpi Type Hpi 30 mA	
1	4 110 91	6	2
1	4 110 92	10	2
1	4 110 94	16	2
1	4 110 95	20	2
1	4 110 96	25	2
1	4 110 97	32	2
1	4 110 98	40	2

RCBOs DX³ 6000 - 10 kA

residual current circuit breakers from 3 A to 63 A - AC, A and Hpi types (continued)



4 111 49

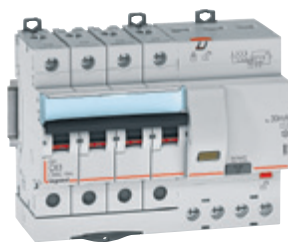

4 111 92



4 112 41

Dimensions **see e-catalogue**
 Technical characteristics **p. 42**

Breaking capacity:
 6000 - IEC 61009-1 - 10 kA / IEC 60947-2 for single pole + neutral, 2 and 4-pole
 • AC type : detect AC component faults
 • A type : detect AC and DC component faults
 • Hpi type (High immunity) : detect AC and DC component faults
 Enhanced immunity to unwanted tripping in disturbed environments
 Can be equipped with DX³ auxiliaries and accessories (p. 40)

Pack	Cat.Nos	2-pole - 230 V~	
		AC Type 10 mA	
		Nominal rating In (A)	Number of modules
1	4 111 49	10	4
1	4 111 50	16	4
1	4 111 51	20	4
		AC Type 30 mA	
1	4 111 57	10	4
1	4 111 58	16	4
1	4 111 59	20	4
1	4 111 60	25	4
1	4 111 61	32	4
1	4 111 62	40	4
1	4 111 63	50	4
1	4 111 64	63	4
		AC Type 300 mA	
1	4 111 71	10	4
1	4 111 72	16	4
1	4 111 73	20	4
1	4 111 74	25	4
1	4 111 75	32	4
1	4 111 76	40	4
1	4 111 77	50	4
1	4 111 78	63	4

Pack	Cat.Nos	4-pole - 400 V~	
		AC Type 30 mA	
		Nominal rating In (A)	Number of modules
1	4 111 85	10	4
1	4 111 86	16	4
1	4 111 87	20	4
1	4 111 88	25	4
1	4 111 89	32	4
1	4 111 90	40	7
1	4 111 91	50	7
1	4 111 92	63	7
		AC Type 300 mA	
1	4 112 04	10	4
1	4 112 05	16	4
1	4 112 06	20	4
1	4 112 07	25	4
1	4 112 08	32	4
1	4 112 09	40	7
1	4 112 10	50	7
1	4 112 11	63	7
		A Type 30 mA	
1	4 112 33	10	4
1	4 112 34	16	4
1	4 112 35	20	4
1	4 112 36	25	4
1	4 112 37	32	4
		A Type 300 mA	
1	4 112 38	10	4
1	4 112 39	16	4
1	4 112 40	20	4
1	4 112 41	25	4
1	4 112 42	32	4

For detailed dimensions,
see e-catalogue



MCBs DX³ 6000 - 10 kA

thermal magnetic circuit breakers from 1 A to 63 A



4 074 35



4 075 65



4 078 02



4 079 34

Dimensions **see e-catalogue**
 Technical characteristics **p. 42**

Conform to IEC 60898-1

Breaking capacity

6000 - IEC 60898-1 - 400 V~

10 kA - IEC 60947-2 - 400 V~

Can be equipped with DX³ auxiliaries and accessories (p. 40)

Pack	Cat.Nos	MCBs DX ³ 6000 - 10 kA - B curve	
		Single pole 230/400 V~	
	B curve	Nominal rating I _n (A)	Number of modules
1	4 074 25	1	1
1	4 074 26	2	1
1	4 074 27	3	1
1	4 074 29	6	1
1	4 074 30	10	1
1	4 074 32	16	1
1	4 074 33	20	1
1	4 074 34	25	1
1	4 074 35	32	1
1	4 074 36	40	1
1	4 074 37	50	1
1	4 074 38	63	1
		2-pole 230/400 V~	
1	4 075 02	1	2
1	4 075 03	2	2
1	4 075 04	3	2
1	4 075 06	6	2
1	4 075 07	10	2
1	4 075 09	16	2
1	4 075 10	20	2
1	4 075 11	25	2
1	4 075 12	32	2
1	4 075 13	40	2
1	4 075 14	50	2
1	4 075 15	63	2
		3-pole 400 V~	
1	4 075 54	1	3
1	4 075 55	2	3
1	4 075 56	3	3
1	4 075 58	6	3
1	4 075 59	10	3
1	4 075 61	16	3
1	4 075 62	20	3
1	4 075 63	25	3
1	4 075 64	32	3
1	4 075 65	40	3
1	4 075 66	50	3
1	4 075 67	63	3
		4-pole 400 V~	
1	4 076 17	1	4
1	4 076 18	2	4
1	4 076 19	3	4
1	4 076 21	6	4
1	4 076 22	10	4
1	4 076 24	16	4
1	4 076 25	20	4
1	4 076 26	25	4
1	4 076 27	32	4
1	4 076 28	40	4
1	4 076 29	50	4
1	4 076 30	63	4

Pack	Cat.Nos	MCBs DX ³ 6000 - 10 kA - C curve	
		Single pole 230/400 V~	
	C curve	Nominal rating I _n (A)	Number of modules
1	4 076 62	1	1
1	4 076 63	2	1
1	4 076 64	3	1
1	4 076 66	6	1
10	4 076 68	10	1
10	4 076 70	16	1
1	4 076 71	20	1
1	4 076 72	25	1
1	4 076 73	32	1
1	4 076 74	40	1
1	4 076 75	50	1
1	4 076 76	63	1
		2-pole 230/400 V~	
1	4 077 92	1	2
1	4 077 93	2	2
1	4 077 94	3	2
1	4 077 96	6	2
1	4 077 98	10	2
1	4 078 00	16	2
1	4 078 01	20	2
1	4 078 02	25	2
1	4 078 03	32	2
1	4 078 04	40	2
1	4 078 05	50	2
1	4 078 06	63	2
		3-pole 400 V~	
1	4 078 51	1	3
1	4 078 52	2	3
1	4 078 53	3	3
1	4 078 55	6	3
1	4 078 57	10	3
1	4 078 59	16	3
1	4 078 60	20	3
1	4 078 61	25	3
1	4 078 62	32	3
1	4 078 63	40	3
1	4 078 64	50	3
1	4 078 65	63	3
		4-pole 400 V~	
1	4 079 20	1	4
1	4 079 21	2	4
1	4 079 22	3	4
1	4 079 24	6	4
1	4 079 26	10	4
1	4 079 28	16	4
1	4 079 29	20	4
1	4 079 30	25	4
1	4 079 31	32	4
1	4 079 32	40	4
1	4 079 33	50	4
1	4 079 34	63	4

MCBs DX³ [6000] - 10 kA - thermal magnetic circuit breakers from 1 A to 63 A (continued)



4 079 67



4 080 33

Dimensions **see e-catalogue**
Technical characteristics **p. 42**

Conform to IEC 60898-1
Breaking capacity
[6000] - IEC 60898-1 - 400 V~
10 kA - IEC 60947-2 - 400 V~
Can be equipped with DX³ auxiliaries and accessories (p. 40)

Pack	Cat.Nos	MCBs DX ³ [6000] - 10 kA - D curve	
Single pole 230/400 V~			
	D curve	Nominal rating I _n (A)	Number of modules
1	4 079 63	1	1
1	4 079 64	2	1
1	4 079 65	3	1
1	4 079 67	6	1
1	4 079 69	10	1
1	4 079 71	16	1
1	4 079 72	20	1
1	4 079 73	25	1
1	4 079 74	32	1
1	4 079 75	40	1
1	4 079 76	50	1
1	4 079 77	63	1
2-pole 230/400 V~			
1	4 080 23	1	2
1	4 080 24	2	2
1	4 080 25	3	2
1	4 080 27	6	2
1	4 080 29	10	2
1	4 080 31	16	2
1	4 080 32	20	2
1	4 080 33	25	2
1	4 080 34	32	2
1	4 080 35	40	2
1	4 080 36	50	2
1	4 080 37	63	2
3-pole 400 V~			
1	4 080 81	1	3
1	4 080 82	2	3
1	4 080 83	3	3
1	4 080 85	6	3
1	4 080 87	10	3
1	4 080 89	16	3
1	4 080 90	20	3
1	4 080 91	25	3
1	4 080 92	32	3
1	4 080 93	40	3
1	4 080 94	50	3
1	4 080 95	63	3
4-pole 400 V~			
1	4 081 43	6	4
1	4 081 45	10	4
1	4 081 47	16	4
1	4 081 48	20	4
1	4 081 49	25	4
1	4 081 50	32	4
1	4 081 51	40	4
1	4 081 52	50	4
1	4 081 53	63	4

AUXILIARIES AND REMOTE CONTROL

Common auxiliaries and motorised controls for DX³ MCBs, RCBOs and RCDs

DISCOVER THE RANGES

- Perfect fitting on protection devices
- Easy to access and visible terminals
- Allow insertion of supply busbars



SIGNALLING
AUXILIARIES,
P. 40



UNDERVOLTAGE
RELEASES,
P. 40



CURRENT
SHUNT TRIPS,
P. 40



MOTORISED
CONTROLS,
P. 40

MORE INFORMATION



► E-CATALOGUE



► QR-CODE



MCBs DX³ 10000 - 16 kA

thermal magnetic circuit breakers from 1 A to 125 A



4 088 69



4 089 43

Dimensions **see e-catalogue**
 Technical characteristics **p. 42**

Conform to IEC 60898-1

Breaking capacity

10000 - IEC 60898-1 - 400 V~

16 kA - IEC 60947-2 - 400 V~

Can be equipped with DX³ auxiliaries and accessories (p. 40)

Pack	Cat.Nos	MCBs DX ³ 10000 - 16 kA - B curve	
		Single pole 230/400 V~	
	B curve	Nominal rating In (A)	Number of modules
1	4 088 65	1	1
1	4 088 66	2	1
1	4 088 67	3	1
1	4 088 69	6	1
1	4 088 70	10	1
1	4 088 71	13	1
1	4 088 72	16	1
1	4 088 73	20	1
1	4 088 74	25	1
1	4 088 75	32	1
1	4 088 76	40	1
1	4 088 77	50	1
1	4 088 78	63	1
		2-pole 230/400 V~	
1	4 089 35	1	2
1	4 089 36	2	2
1	4 089 37	3	2
1	4 089 39	6	2
1	4 089 40	10	2
1	4 089 41	13	2
1	4 089 42	16	2
1	4 089 43	20	2
1	4 089 44	25	2
1	4 089 45	32	2
1	4 089 46	40	2
1	4 089 47	50	2
1	4 089 48	63	2
		3-pole 400 V~	
1	4 089 84	1	3
1	4 089 85	2	3
1	4 089 86	3	3
1	4 089 88	6	3
1	4 089 89	10	3
1	4 089 90	13	3
1	4 089 91	16	3
1	4 089 92	20	3
1	4 089 93	25	3
1	4 089 94	32	3
1	4 089 95	40	3
1	4 089 96	50	3
1	4 089 97	63	3

Pack	Cat.Nos	MCBs DX ³ 10000 - 16 kA - B curve (continued)	
		4-pole 400 V~	
	B curve	Nominal rating In (A)	Number of modules
1	4 090 58	1	4
1	4 090 59	2	4
1	4 090 60	3	4
1	4 090 62	6	4
1	4 090 63	10	4
1	4 090 64	13	4
1	4 090 65	16	4
1	4 090 66	20	4
1	4 090 67	25	4
1	4 090 68	32	4
1	4 090 69	40	4
1	4 090 70	50	4
1	4 090 71	63	4

MCBs DX³ 10000 - 16 kA

thermal magnetic circuit breakers from 1 A to 125 A (continued)

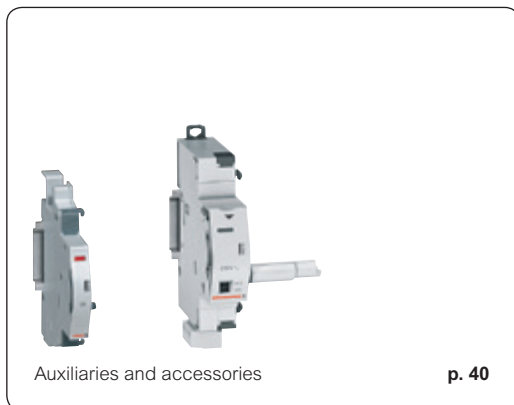
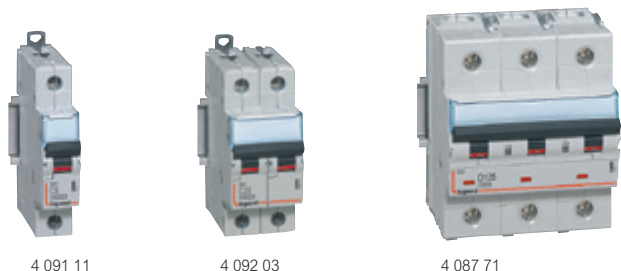

Dimensions **see e-catalogue**
 Technical characteristics **p. 42**

Conform to IEC 60898-1
 Breaking capacity
 10000 - IEC 60898-1 - 400 V~
 16 kA - IEC 60947-2 - 400 V~
 Can be equipped with DX³ auxiliaries and accessories (p. 40)

Pack	Cat.Nos	MCBs DX ³ 10000 - 16 kA - C curve	
		Single pole 230/400 V~	
	C curve	Nominal rating In (A)	Number of modules
1	4 091 07	1	1
1	4 091 08	2	1
1	4 091 09	3	1
1	4 091 11	6	1
1	4 091 12	10	1
1	4 091 13	13	1
1	4 091 14	16	1
1	4 091 15	20	1
1	4 091 16	25	1
1	4 091 17	32	1
1	4 091 18	40	1
1	4 091 19	50	1
1	4 091 20	63	1
1	4 085 99	80	1.5
1	4 086 00	100	1.5
1	4 086 01	125	1.5
		2-pole 230/400 V~	
1	4 091 95	1	2
1	4 091 96	2	2
1	4 091 97	3	2
1	4 091 99	6	2
1	4 092 00	10	2
1	4 092 01	13	2
1	4 092 02	16	2
1	4 092 03	20	2
1	4 092 04	25	2
1	4 092 05	32	2
1	4 092 06	40	2
1	4 092 07	50	2
1	4 092 08	63	2
1	4 086 40	80	3
1	4 086 41	100	3
1	4 086 42	125	3
		3-pole 400 V~	
1	4 092 47	1	3
1	4 092 48	2	3
1	4 092 49	3	3
1	4 092 51	6	3
1	4 092 52	10	3
1	4 092 53	13	3
1	4 092 54	16	3
1	4 092 55	20	3
1	4 092 56	25	3
1	4 092 57	32	3
1	4 092 58	40	3
1	4 092 59	50	3
1	4 092 60	63	3
1	4 086 62	80	4.5
1	4 086 63	100	4.5
1	4 086 64	125	4.5

Pack	Cat.Nos	MCBs DX ³ 10000 - 16 kA - C curve (continued)	
		4-pole 400 V~	
	C curve	Nominal rating In (A)	Number of modules
1	4 093 29	1	4
1	4 093 30	2	4
1	4 093 31	3	4
1	4 093 33	6	4
1	4 093 34	10	4
1	4 093 35	13	4
1	4 093 36	16	4
1	4 093 37	20	4
1	4 093 38	25	4
1	4 093 39	32	4
1	4 093 40	40	4
1	4 093 41	50	4
1	4 093 42	63	4
1	4 087 03	80	6
1	4 087 04	100	6
1	4 087 05	125	6
		MCBs DX³ 10000 - 16 kA - D curve	
	D curve	Nominal rating In (A)	Number of modules
1	4 087 69	80	4.5
1	4 087 70	100	4.5
1	4 087 71	125	4.5

For detailed dimensions,
see e-catalogue



MCBs DX³ - 25 kA

thermal magnetic MCBs from 2 A to 125 A

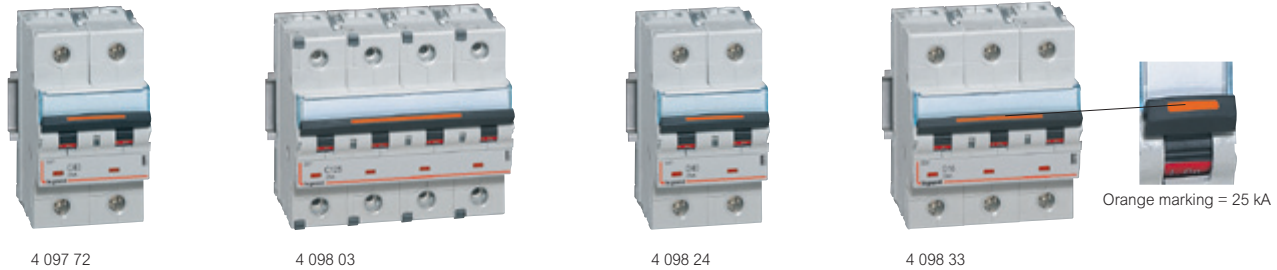

Dimensions **see e-catalogue**
 Technical characteristics **p. 42**

Breaking capacity:
 25 kA - IEC 60947-2 - 400 V~
 Can be equipped with DX³ auxiliaries and accessories (p. 40)

Pack	Cat.Nos	MCBs DX ³ - 25 kA - C curve		Pack	Cat.Nos	MCBs DX ³ - 25 kA - D curve	
		Single pole 230/400 V~				Single pole 230/400 V~	
		Nominal rating In (A)	Number of modules			Nominal rating In (A)	Number of modules
1	4 097 52	2	1	1	4 098 04	2	1
1	4 097 53	6	1	1	4 098 05	6	1
1	4 097 54	10	1	1	4 098 06	10	1
1	4 097 55	16	1	1	4 098 07	16	1.5
1	4 097 56	20	1	1	4 098 08	20	1.5
1	4 097 57	25	1	1	4 098 09	25	1.5
1	4 097 58	32	1.5	1	4 098 10	32	1.5
1	4 097 59	40	1.5	1	4 098 11	40	1.5
1	4 097 60	50	1.5	1	4 098 12	50	1.5
1	4 097 61	63	1.5	1	4 098 13	63	1.5
1	4 097 62	80	1.5	1	4 098 14	80	1.5
1	4 097 63	100	1.5	1	4 098 15	100	1.5
1	4 097 64	125	1.5	1	4 098 16	125	1.5
		2-pole - 230/400 V~				2-pole - 230/400 V~	
1	4 097 65	2	2	1	4 098 17	2	2
1	4 097 66	6	2	1	4 098 18	6	2
1	4 097 67	10	2	1	4 098 19	10	2
1	4 097 68	16	2	1	4 098 20	16	2
1	4 097 69	20	2	1	4 098 21	20	2
1	4 097 70	25	2	1	4 098 22	25	2
1	4 097 71	32	2	1	4 098 23	32	3
1	4 097 72	40	3	1	4 098 24	40	3
1	4 097 73	50	3				
1	4 097 74	63	3				
1	4 097 75	80	3				
1	4 097 76	100	3				
1	4 097 77	125	3				
		3-pole - 400 V~				3-pole - 400 V~	
1	4 097 78	2	3	1	4 098 30	2	3
1	4 097 79	6	3	1	4 098 31	6	3
1	4 097 80	10	3	1	4 098 32	10	3
1	4 097 81	16	3	1	4 098 33	16	4.5
1	4 097 82	20	3	1	4 098 34	20	4.5
1	4 097 83	25	3	1	4 098 35	25	4.5
1	4 097 84	32	4.5	1	4 098 36	32	4.5
1	4 097 85	40	4.5	1	4 098 37	40	4.5
1	4 097 86	50	4.5	1	4 098 38	50	4.5
1	4 097 87	63	4.5	1	4 098 39	63	4.5
1	4 097 88	80	4.5	1	4 098 40	80	4.5
1	4 097 89	100	4.5	1	4 098 41	100	4.5
1	4 097 90	125	4.5	1	4 098 42	125	4.5
		4-pole - 400 V~				4-pole - 400 V~	
1	4 097 91	2	4	1	4 098 43	2	4
1	4 097 92	6	4	1	4 098 44	6	4
1	4 097 93	10	4	1	4 098 45	10	4
1	4 097 94	16	4	1	4 098 46	16	6
1	4 097 95	20	4	1	4 098 47	20	6
1	4 097 96	25	4	1	4 098 48	25	6
1	4 097 97	32	6	1	4 098 49	32	6
1	4 097 98	40	6	1	4 098 50	40	6
1	4 097 99	50	6	1	4 098 51	50	6
1	4 098 00	63	6	1	4 098 52	63	6
1	4 098 01	80	6	1	4 098 53	80	6
1	4 098 02	100	6	1	4 098 54	100	6
1	4 098 03	125	6	1	4 098 55	125	6

DX³ - 25 kA Z curve MCBs,
please consult us

MCBs DX³ - 36 kA

thermal magnetic MCBs from 10 A to 80 A



Dimensions **see e-catalogue**
Technical characteristics **p. 42**

Breaking capacity:
36 kA - IEC 60947-2 - 400 V \sim
Can be equipped with DX³ auxiliaries and accessories (p. 40)

Pack	Cat.Nos	MCBs DX ³ - 36 kA - C curve	
		2-pole - 230/400 V\sim	
		Nominal rating In (A)	Number of modules
1	4 100 07	10	1.5
1	4 100 08	16	1.5
1	4 100 09	20	1.5
1	4 100 10	25	1.5
1	4 100 11	32	1.5
1	4 100 12	40	1.5
1	4 100 13	50	1.5
1	4 100 14	63	1.5
1	4 100 15	80	1.5
		3-pole - 400 V\sim	
1	4 100 20	10	4.5
1	4 100 21	16	4.5
1	4 100 22	20	4.5
1	4 100 23	25	4.5
1	4 100 24	32	4.5
1	4 100 25	40	4.5
1	4 100 26	50	4.5
1	4 100 27	63	4.5
1	4 100 28	80	4.5
		4-pole - 400 V\sim	
1	4 100 33	10	6
1	4 100 34	16	6
1	4 100 35	20	6
1	4 100 36	25	6
1	4 100 37	32	6
1	4 100 38	40	6
1	4 100 39	50	6
1	4 100 40	63	6
1	4 100 41	80	6

MCBs DX³ - 50 kA

thermal magnetic MCBs from 10 A to 63 A



Dimensions **see e-catalogue**
Technical characteristics **p. 42**

Breaking capacity:
50 kA - IEC 60947-2 - 400 V \sim
Can be equipped with DX³ auxiliaries and accessories (p. 40)

Pack	Cat.Nos		MCBs DX ³ - 50 kA - D curve	
			Single pole 230/400 V\sim	
			Nominal rating In (A)	Number of modules
1	C curve	D curve	10	1.5
1	4 101 34	4 101 86	16	1.5
1	4 101 35	4 101 87	20	1.5
1	4 101 36	4 101 88	25	1.5
1	4 101 37	4 101 89	32	1.5
1	4 101 38	4 101 90	40	1.5
1	4 101 39	4 101 91	50	1.5
1	4 101 40	4 101 92	63	1.5
1	4 101 41	4 101 93		
			2-pole - 230/400 V\sim	
1	4 101 47	4 101 99	10	3
1	4 101 48	4 102 00	16	3
1	4 101 49	4 102 01	20	3
1	4 101 50	4 102 02	25	3
1	4 101 51	4 102 03	32	3
1	4 101 52	4 102 04	40	3
1	4 101 53		50	3
1	4 101 54		63	3
			3-pole - 400 V\sim	
1	4 101 60	4 102 12	10	4.5
1	4 101 61	4 102 13	16	4.5
1	4 101 62	4 102 14	20	4.5
1	4 101 63	4 102 15	25	4.5
1	4 101 64	4 102 16	32	4.5
1	4 101 65	4 102 17	40	4.5
1	4 101 66	4 102 18	50	4.5
1	4 101 67	4 102 19	63	4.5
			4-pole - 400 V\sim	
1	4 101 73	4 102 25	10	6
1	4 101 74	4 102 26	16	6
1	4 101 75	4 102 27	20	6
1	4 101 76	4 102 28	25	6
1	4 101 77	4 102 29	32	6
1	4 101 78	4 102 30	40	6
1	4 101 79	4 102 31	50	6
1	4 101 80	4 102 32	63	6

For detailed dimensions,
see e-catalogue



Add-on modules DX³

for 1 module/pole DX³ MCBs



4 104 01



4 104 71

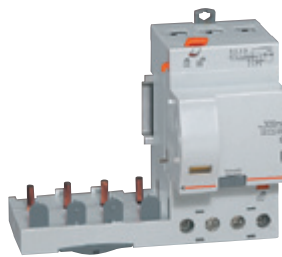

4 105 55

Dimensions **see e-catalogue**
Technical characteristics **p. 43**

Conform to IEC 61009-1

- AC type : detect AC components faults
- A type : detect AC and DC component faults
- Hpi type **Hpi**: detect faults with AC and DC components, increased immunity to false tripping

For mounting on the right-hand side of 1 module per pole DX³ MCBs

Pack	Cat.Nos	2-pole - 230 V \sim	
		AC Type 30 mA	
		Nominal rating In (A)	Number of modules
1	4 104 01	40	2
1	4 104 02	63	2
		AC Type 300 mA	
1	4 104 13	40	2
1	4 104 14	63	2
		AC Type 300 mA selective	
1	4 104 24	63	2
		AC Type 1000 mA selective	
1	4 104 26	63	2
		A Type 30 mA	
1	4 104 28	40	2
1	4 104 29	63	2
		A Type 300 mA	
1	4 104 31	40	2
1	4 104 32	63	2
		Hpi Type Hpi 30 mA	
1	4 104 35	63	2

Pack	Cat.Nos	3-pole - 400 V \sim	
		AC Type 30 mA	
		Nominal rating In (A)	Number of modules
1	4 104 71	40	3
1	4 104 72	63	3
		AC Type 300 mA	
1	4 104 74	40	3
1	4 104 75	63	3
		AC Type 300 mA selective	
1	4 104 77	63	3
		A Type 30 mA	
1	4 104 80	63	3
		A Type 300 mA	
1	4 104 83	63	3
		Hpi Type Hpi 30 mA	
1	4 104 86	63	3

Pack	Cat.Nos	4-pole - 400 V \sim	
		AC Type 30 mA	
		Nominal rating In (A)	Number of modules
1	4 104 99	40	3
1	4 105 00	63	3
		AC Type 300 mA	
1	4 105 11	40	3
1	4 105 12	63	3
		AC Type 300 mA selective	
1	4 105 21	63	3
		AC Type 1000 mA selective	
1	4 105 23	63	3
		A Type 30 mA	
1	4 105 25	40	3
1	4 105 26	63	3
		A Type 300 mA	
1	4 105 28	40	3
1	4 105 29	63	3
		A Type 300 mA selective	
1	4 105 31	63	3
		Hpi Type Hpi 30 mA	
1	4 105 34	63	3
		Hpi Type Hpi 300 mA selective	
1	4 105 55	63	3

Add-on modules DX³

for 1.5 module/pole DX³ MCBs

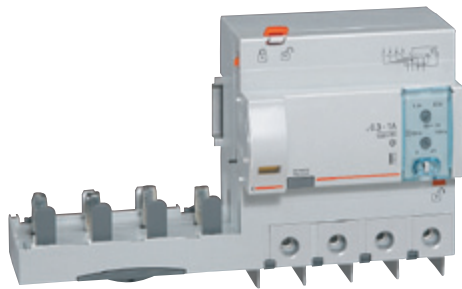

4 106 43

Dimensions **see e-catalogue**
Technical characteristics **p. 43**

Conform to IEC 61009-1

- AC type : detect AC components faults
- Hpi type : detect faults with AC and DC components, increased immunity to false tripping

For mounting on the right-hand side of 1.5 module per pole DX³ MCBs

Pack	Cat.Nos		
		2-pole - 230 V[~]	
		AC Type 30 mA	
		Nominal rating In (A)	Number of modules
1	4 105 68	125	4
		AC Type 300 mA	
1	4 105 71	125	4
		Hpi Type Hpi 30 mA	
1	4 105 76	63	2
1	4 105 78	125	4
		Hpi Type Hpi 300 mA	
1	4 105 82	125	4
		Hpi Type Hpi adjustable from 300 to 1000 mA	
1	4 105 83	63	4
		3-pole - 400 V[~]	
		Hpi Type Hpi 30 mA	
		Nominal rating In (A)	Number of modules
1	4 106 05	63	3
		Hpi Type Hpi 300 mA	
1	4 106 08	63	3
		Hpi Type Hpi adjustable from 300 to 1000 mA	
1	4 106 11	63	6
		4-pole - 400 V[~]	
		AC Type 30 mA	
		Nominal rating In (A)	Number of modules
1	4 106 25	125	6
		AC Type 300 mA	
1	4 106 29	125	6
		Hpi Type Hpi 30 mA	
1	4 106 36	63	3
1	4 106 38	125	6
		Hpi Type Hpi 300 mA	
1	4 106 40	63	3
1	4 106 42	125	6
		Hpi Type Hpi adjustable from 300 to 1000 mA	
1	4 106 43	63	6

Add-on modules DX³

Compatibility MCBs/add-on modules

Breaking capacity	Curve	Number of poles	Add-on module for 1 module/pole MCBs	Add-on module for 1.5 module/pole MCBs
6000 / 10 kA	B, C, D	2P, 3P, 4P	All range	-
10000 / 16 kA	B, C, D	2P, 3P, 4P	In ≤ 63 A	In ≥ 80 A
25 kA	B, C, Z	3P, 4P	In ≤ 25 A	In ≥ 32 A
		2P	In ≤ 32 A	In ≥ 40 A
	D	3P, 4P	In ≤ 10 A	In ≥ 12,5 A
		2P	In ≤ 25 A	In ≥ 32 A
50 kA	B, C, D	2P, 3P, 4P		All range

Adjustable add-on modules, Hpi type

Easy to access settings on front panel with sealable transparent cover

Sensitivity: 300, 500 and 1000 mA

Time delay: instantaneous, selective (60 ms) or delayed (150 ms)

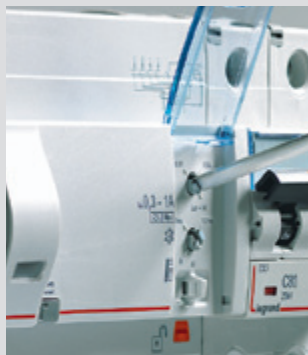

For detailed dimensions,
see e-catalogue



Auxiliaries, remote control and accessories DX³

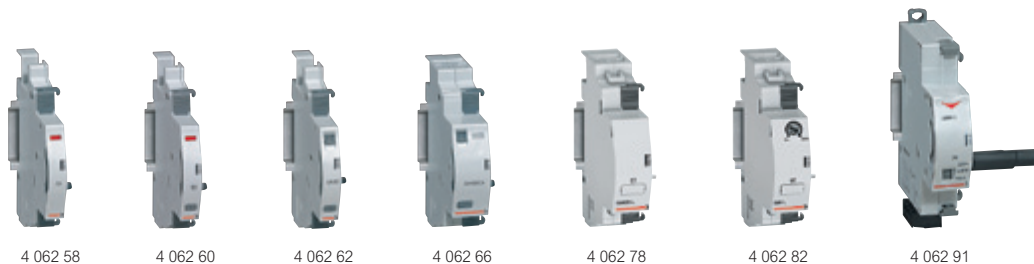

Technical characteristics p. 42

Pack	Cat.Nos	Auxiliaries	No. of modules
		Mounted on the left-hand side of the devices Possible configuration per device: 3 auxiliaries including 1 control auxiliary Auxiliaries common to MCBs, RCBOs RCDs and isolating switches Allow insertion of the supply busbar	
1	4 062 58	Signalling auxiliaries Auxiliary changeover switch, 6 A - 250 V \sim Indicates the position of the contacts of the MCB, RCD or isolating switch	0.5
1	4 062 60	Fault signalling changeover switch, 6 A - 250 V \sim Indicates opening on a fault	0.5
1	4 062 62	Auxiliary changeover switch, 6 A - 250 V \sim Can be changed to a fault signalling changeover switch	0.5
1	4 062 66	Auxiliary changeover switch + fault signalling changeover switch, 6 A - 250 V \sim Can be changed to 2 auxiliary changeover switches	1
		Current shunt trips Used for remote tripping of an MCB, RCD, RCBO or isolating switch at the supply end	
1	4 062 76	12 to 48 V \sim /=	1
1	4 062 78	110 to 415 V \sim	1
		Undervoltage releases Time delay adjustable from 0 to 300 ms	
1	4 062 80	24 to 48 V \sim /=	1
1	4 062 82	230 V \sim	1
		Stand-alone release for N/C push-button Used for positive safety tripping on the control circuit via an N/C push-button Prevents the device with which it is used tripping if there is no supply voltage, while retaining the possibility of tripping via the control circuit for 60 hours minimum Not suitable for the supply circuits of moving machinery (e.g.: machine tools)	
1	4 062 87	Stand-alone release, 230 V \sim supplied with battery	1.5
1	4 062 85	Replacement battery for release Cat.No 4 062 87	

Pack	Cat.Nos	Motorised controls	No. of modules
		For mounting on the left-hand side of 1 module/pole MCBs, RCBOs and RCDs Enable the products with which they are used to be opened and closed remotely Take one control auxiliary and one signalling auxiliary The signalling auxiliary must be placed between the remote control and the control auxiliary	
		Standard	
		Control voltage 230 V \sim	No. of modules 1
1	4 062 91		1
		With integrated automatic resetting Automatically resets the product with which it is used, thus ensuring continuity of service	
1	4 062 93	24-48 V \sim /=	2
1	4 062 95	230 V \sim	2
		Accessories	
		Padlocking Support for one \varnothing 5 or \varnothing 6 mm padlock for DX ³ MCBs and RCDs or isolating switches	
2	4 063 03		
1	0 227 97	\varnothing 6 shackle type padlock	
3	4 063 13	\varnothing 5 shackle type padlock	
		Sealable screw cover - 4 separable poles	
2	4 063 04	For DX ³ MCBs, 1 module per pole	
2	4 063 12	For DX ³ MCBs, 1.5 module per pole	
		Insulating shields For DX ³ MCBs, 1 module per pole	
1	4 063 05	Pole insulating shield (set of 6)	
		Spacing units with feedthrough 0.5 module	
10	4 063 07		
		Aluminium terminals	
1	4 063 10	50 mm ²	
1	4 063 11	95 mm ² for 1.5 module/pole MCBs	
		Terminal shields For 1.5 module/pole products (set of 2)	
1	4 063 06		

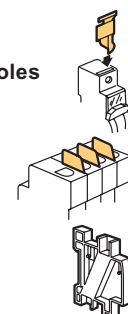

STOP&GO automatic resetting for DX³



4 062 88

Pack	Cat.Nos	STOP&GO automatic resetting	
1	4 062 88	Standard Control voltage 230 V~	No. of modules 2
1	4 062 95	Self-test unit With periodic testing of the residual current device with which it is used (sensitivity 30 mA or less) 230 V~	2

For mounting on the left-hand side of 2 module Ph+N or 2P RCDs, MCBs, RCBOs ≤ 63 A
 Automatically reset the device with which they are used in the event of false tripping after a transient fault (e.g. : lightning)
 Check the condition of the installation before resetting
 Indicate any permanent fault (residual current or short-circuit fault)
 Take one control auxiliary and one signalling auxiliary

STOP&GO automatic resetting for DX³

Operating principle

Temporarily electrical disturbances and other external events can cause unwanted tripping of different devices protecting electrical installation

STOP&GO verifies automatically the state of the installation, before resetting and launches a visual and audible alarm signal in case of permanent fault detection (short-circuit or residual current)

After verifying the state of the installation, STOP&GO automatic resets the associated protection device in order to immediately re-establish power supply and avoid unwanted consequences

STOP&GO does not protect the installation against lightning strikes
 For an efficient protection against lightning, use voltage surge protectors

The Autotest version is specially suitable for installations equipped with residual current protection devices (RCD's and RCBOs)
 STOP&GO periodically does an automatic test of the functioning of residual current protection devices. The manual test is no longer needed

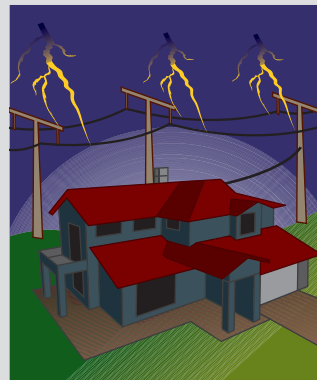

Installation without STOP&GO

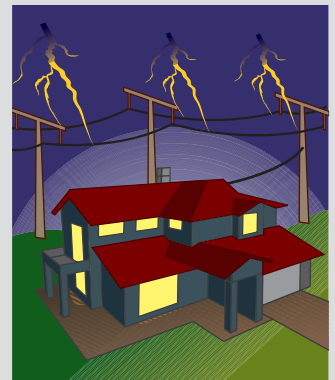

Installation with STOP&GO

Mains fault due to temporarily electrical disturbances
 Electrical devices are not powered anymore

STOP&GO automatic resets the associated protection device in order to immediately re-establish power supply

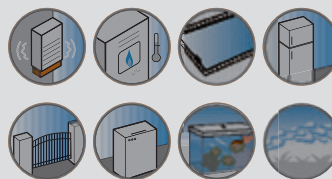

Performance of MCBs and auxiliaries

Breaking capacity in IT neutral earthing system

MCB single pole breaking capacity at 400 V according to IEC 60947-2

DX ³ 10000 16 kA	1P/2P/3P/4P	4 kA
DX ³ 25 kA	1P/2P/3P/4P	6.25 kA
DX ³ 36 kA	2P/3P/4P	9 kA
DX ³ 50 kA	1P/2P/3P/4P	12.5 kA

Breaking capacity in the event of short-circuit to earth and insulation voltage

	1P/2P/3P/4P 230/400 V~ MCBs			
	DX ³ 10000 16 kA	DX ³ 25 kA	DX ³ 36 kA	DX ³ 50 kA
Icn1	16000 A	25000 A	36000 A	50000 A
Ui	500 V	500 V	500 V	500 V

Icn1: Breaking capacity on 1 pole for multipole MCBs in the event of short-circuit to earth

Ui: Rated insulation voltage

Terminal connection cross-sections (mm²)

Copper cable	Rigid	Flexible
	DX ³ 6000 10 kA	35
DX ³ 10000 16 kA	35	25
DX ³ 80 to 125 A	70	50
DX ³ 25 kA ≥ 32 A (C curve) ≥ 16 A (D curve)	50	35
DX ³ 36 kA, DX ³ 50 kA and add-on modules	50	35
Auxiliaries	2.5	2.5

MCB tripping curves

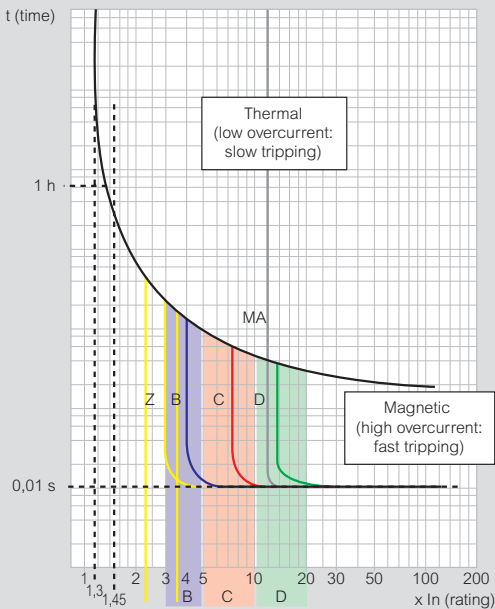

Thermal tripping for an ambient temperature 30°C
 I_n = nominal current (rating) of MCB

Curves	Magnetic threshold settings
Z ⁽¹⁾	2.4 to 3.6 I_n
B	3 to 5 I_n
C	5 to 10 I_n
D	10 to 14 I_n (10 to 20 acc. to the stds)
MA ⁽¹⁾	12 to 14 I_n

1: On request

Technical characteristics of auxiliaries

Max. connection cross-section: 2.5 mm²
 Operating temperature: - 25°C to + 70°C

Shunt trips

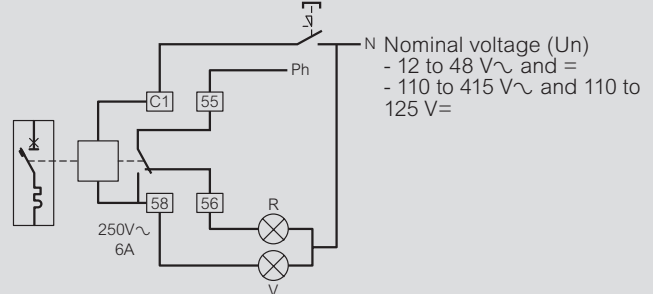

Equipped with a signalling contact which indicates tripping of the shunt trip and automatically breaks the coil.

Min. and max. voltage: 0.7 to 1.1 U_n

Tripping time: less than 20 ms

Power consumption: at 1.1 x 48 V = 121 VA
 at 1.1 x 415 V = 127 VA

Impedance: 12 to 48 V = 23 Ω
 110 to 415 V = 1640 Ω

Consumption	Umin.	Umax.
12 to 48 V	522 mA	2610 mA
110 to 415 V	69 mA	259 mA

Undervoltage releases

Pull-in voltage ≥ 0.55 U_n

Tripping time: 100 to 400 ms ± 10% (adjustable)

Power consumption: 24 V~ and = : 0.1 VA
 48 V~ and = : 0.2 VA
 230 V~ : 1 VA

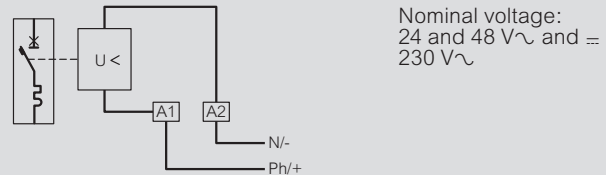

Stand-alone releases for N/C push-buttons

Min. and max. operating voltage: 196 to 250 V~

Power consumption: 1.4 VA

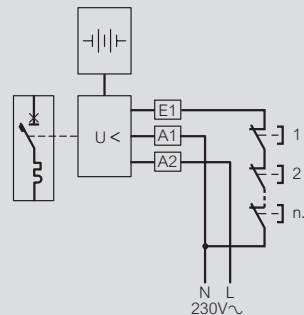

Signalling auxiliaries

Umin.: 24 V~ / = and Imin.: 5 mA

Performance of add-on modules

AC type - Standard applications

Detection of 50-60 Hz AC residual currents

A type - Specific applications: dedicated lines

In addition to the characteristics of AC type add-on modules, A type add-on modules also detect residual currents with DC components. They are used whenever the fault currents are not sinusoidal. They are particularly suitable for the following dedicated line applications:

- On circuits where class 1 equipment may produce fault currents with DC components, such as variable speed drives with frequency inverter, etc.

Hpi type - Special applications

Hpi add-on modules, with additional immunity to false tripping, which is much higher than the level required by the standard, detect residual currents with AC and DC components (A type), operate between - 25°C and + 40°C, and are used in the following special cases:

- When loss of data would be detrimental, such as computer equipment power supply lines (banks, military instrumentation, airline reservation centres, etc.)
- When loss of operation would be detrimental (automated machines, medical instrumentation, freezer lines, etc.)
- In places where there is a high risk of lightning strikes
- On sites with lines subject to considerable interference (use of fluorescent lights, etc)
- On sites with very long lines

Special case of continuity of service

In certain locations where no staff are present and in which continuity of service is particularly important, false tripping of MCBs is not permitted (isolated telephone/TV or radio substations, pumping stations, etc.)
Combining an Hpi RCBO with a motorised control and a STOP & GO recloser provides optimum continuity of service

Average residual current performance curves

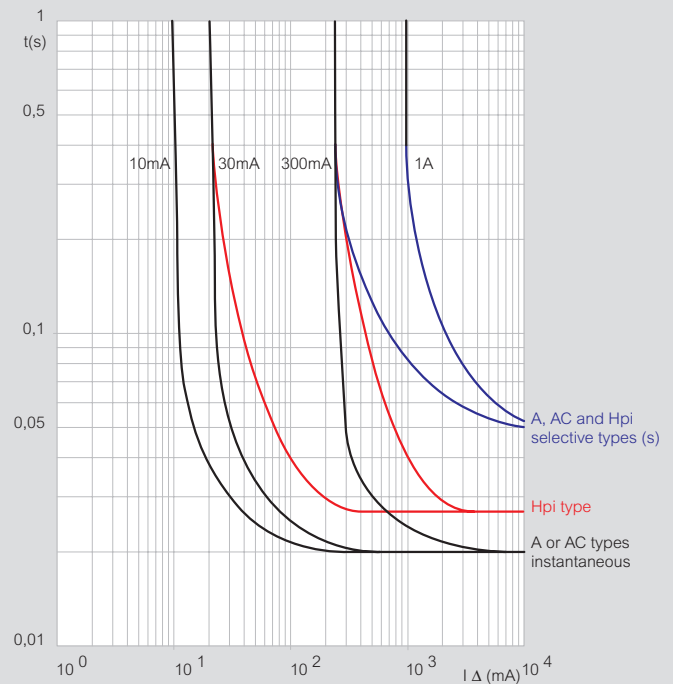

Residual current breaking capacity of DX³ add-on modules

I Δ m according to EN 61009-1
AC, A and Hpi add-on modules

DX ³ add-on modules used with an MCB		I Δ m
DX ³ (1 mod./pole)	25 kA \leq 25 A (B, C, Z curves)	6000 A
	25 kA \leq 10 A (D, MA curves)	
DX ³ (1.5 mod./pole)	<u>10000</u> 16 kA (80 to 125 A)	30000 A
	25 kA \geq 32 A (B, C, Z curves)	
	25 kA \geq 12.5 A (D, MA curves)	
	36 kA	
	50 kA	

Selectivity tables

MCBs/MCBs (in A)

Downstream MCB	Upstream MCB	DX ³ [6000] - 10 kA / DX ³ [10000] - 16 kA				DX ³ [6000] - 10 kA / DX ³ [10000] - 16 kA						
		B curve				C curve						
	In (A)	32	40	50	63	32	40	50	63	80	100	125
DX ³ [6000] - 10 kA B & C curve	≤ 6	128	160	200	252	240	300	375	472	4000	T	T
	10	128	160	200	252	240	300	375	472	3000	5000	T
	13	128	160	200	252	240	300	375	472	2500	4000	6000
	16	128	160	200	252	240	300	375	472	2000	3600	5500
	20		160	200	252	240	300	375	472	1600	3000	4000
	25			200	252	240	300	375	472	1300	2400	3300
	32				252		300	375	472	1000	1800	2700
	40							375	472	800	1600	2400
	50								472	800	900	1700
	63									650	900	1200
DX ³ [10000] - 16 kA B & C curve	≤ 6	128	160	200	252	240	300	375	472	4000	T	T
	10	128	160	200	252	240	300	375	472	3000	5000	T
	16	128	160	200	252	240	300	375	472	2000	3600	5500
	20		160	200	252	240	300	375	472	1600	3000	4000
	25			200	252	240	300	375	472	1300	2400	3300
	32				252		300	375	472	1000	1800	2700
	40							375	472	800	1600	2400
	50								472	800	900	1700
	63									650	900	1200
	80										600	750
100											750	
DX ³ [10000] - 16 kA D curve	80											
	100											
	125											
DX ³ 25 kA B & C curve	≤ 6					240	300	375	472	4000	T	T
	10					240	300	375	472	3000	5000	T
	16					240	300	375	472	2000	3600	5500
	20					240	300	375	472	1600	3000	4000
	25					240	300	375	472	1300	2400	3300
	32						300	375	472	1000	1800	2700
	40							375	472	800	1600	2400
	50								472	800	900	1700
	63									650	900	1200
	80										600	750
100											750	
DX ³ 25 kA D curve	≤ 6											
	10											
	16											
	20											
	25											
	32											
	40											
	50											
	63											
	80											
DX ³ 36 kA C curve	≤ 6											
	10											
	16											
	20											
	25											
	32											
	40											
	50											
	63											
	80											
DX ³ 50 kA B & C curve	10											
	16											
	20											
	25											
	32											
	40											
DX ³ 50 kA D curve	10											
	16											
	20											
	25											
	32											
	40											

T: total selectivity, up to downstream circuit breaker breaking capacity according to IEC 60947-2
 The magnetic threshold and the nominal rating of the downstream MCB must always be inferior to the ones of the upstream MCB

Back up between MCCBs and MCBs (in kA)

In 3 phases networks + N 400/415 V according to IEC 60947-2

MCBs/MCCBs upstream		DX ³ [10000] 16 kA B, C and D curves 10 to 125 A	DX ³ 25 kA B, C and D curves 10 to 125 A	DX ³ 50 kA C and D curves 10 to 63 A	DPX-E 125 16 kA 16 to 125 A	DPX 125 25 kA 16 to 125 A 36 kA 16 to 125 A			DPX 160 25 kA 63 to 160 A 36 kA 63 to 160 A 50 kA 40 to 160 A		
MCBs downstream											
DX ³ [6000] - 10 kA B, C and D curves	≤ 20 A	16 kA	25 kA	50 kA	16 kA	25 kA	25 kA	25 kA	25 kA	25 kA	25 kA
	25 A	16 kA	25 kA	50 kA	16 kA	25 kA	25 kA	25 kA	25 kA	25 kA	25 kA
	32 A	16 kA	25 kA	50 kA	16 kA	25 kA	25 kA	25 kA	25 kA	25 kA	25 kA
	40 A	16 kA	25 kA	50 kA	16 kA	25 kA	25 kA	25 kA	25 kA	25 kA	25 kA
	50 A	16 kA	25 kA	50 kA	16 kA	25 kA	25 kA	25 kA	25 kA	25 kA	25 kA
DX ³ [10000] - 16 kA B, C and D curves	63 A	-	-	-	16 kA	25 kA	25 kA	20 kA	20 kA	20 kA	20 kA
	≤ 20 A	-	25 kA	50 kA	16 kA	25 kA	25 kA	25 kA	25 kA	25 kA	25 kA
	25 A	-	25 kA	50 kA	16 kA	25 kA	25 kA	25 kA	25 kA	25 kA	25 kA
	32 A	-	25 kA	50 kA	16 kA	25 kA	25 kA	25 kA	25 kA	25 kA	25 kA
	40 A	-	25 kA	50 kA	16 kA	25 kA	25 kA	25 kA	25 kA	25 kA	25 kA
	50 A	-	25 kA	50 kA	16 kA	25 kA	25 kA	25 kA	25 kA	25 kA	25 kA
	63 A	-	-	-	16 kA	25 kA	25 kA	20 kA	20 kA	20 kA	20 kA
80 et 100 A	-	-	-	16 kA	20 kA	20 kA	20 kA	20 kA	20 kA	20 kA	
125 A	-	-	-	-	-	30 kA	20 kA	20 kA	20 kA	20 kA	
DX ³ 25 kA B and C curve	≤ 25 A	-	-	50 kA	-	-	30 kA	-	30 kA	30 kA	30 kA
	32 to 50 A	-	-	50 kA	-	-	30 kA	-	30 kA	30 kA	30 kA
	63 to 80 A	-	-	-	-	-	30 kA	-	30 kA	30 kA	30 kA
	100 et 125 A	-	-	-	-	-	30 kA	-	30 kA	30 kA	30 kA
DX ³ 25 kA D curves	≤ 10 A	-	-	50 kA	-	-	30 kA	-	30 kA	30 kA	30 kA
	16 to 63 A	-	-	50 kA	-	-	30 kA	-	30 kA	30 kA	30 kA
DX ³ 36 kA C curve	10 to 50 A	-	-	50 kA	-	-	-	-	-	-	-
	63 A	-	-	-	-	-	-	-	-	-	-
	80 A	-	-	-	-	-	-	-	-	-	-
DX ³ 50 kA C and D curves	≤ 4 to 63 A	-	-	-	-	-	-	-	-	-	

In 3 phases networks + N 230/240 V according to IEC 60947-2

MCBs/MCCBs upstream		DX ³ [10000] 16 kA B, C and D curves		DX ³ 25 kA B, C and D curves		DX ³ 50 kA C curves		DX ³ 50 kA D curves		DPX 125 25 kA 16 to 125 A 36 kA 16 to 125 A	
MCBs downstream		≤ 32 A	40 to 125 A	≤ 32 A	40 to 125 A	≤ 32 A	40 to 63 A	≤ 32 A	40 to 63 A		
DX ³ [6000] - 10 kA B, C and D curves	≤ 20 A	32 kA	25 kA	50 kA	25 kA	50 kA	50 kA	50 kA	50 kA	35 kA	40 kA
	25 to 40 A	-	25 kA	-	25 kA	-	50 kA	-	50 kA	35 kA	40 kA
	50 A	-	25 kA	-	25 kA	-	-	-	-	25 kA	25 kA
	63 A	-	25 kA	-	25 kA	-	-	-	-	25 kA	25 kA
DX ³ [10000] - 16 kA B, C and D curves	≤ 20 A	-	-	50 kA	32 kA	70 kA	70 kA	70 kA	70 kA	35 kA	40 kA
	25 to 40 A	-	-	-	32 kA	-	70 kA	-	70 kA	35 kA	40 kA
	50 et 63 A	-	-	-	32 kA	-	-	-	-	35 kA	35 kA
	80 to 125 A	-	-	-	-	-	-	-	-	35 kA	35 kA
DX ³ 25 kA B and C curves	≤ 25 A	-	-	-	-	50 kA	50 kA	70 kA	70 kA	-	-
	32 to 125 A	-	-	-	-	65 kA	50 kA	-	70 kA	-	-
DX ³ 25 kA D curves	≤ 10 A	-	-	-	-	50 kA	50 kA	70 kA	70 kA	-	-
	16 to 63 A	-	-	-	-	65 kA	50 kA	70 kA	70 kA	-	-
DX ³ 36 kA C curve	10 to 50 A	-	-	-	-	85 kA	72 kA	-	-	-	-
	63 A	-	-	-	-	-	-	-	-	-	-
	80 A	-	-	-	-	-	-	-	-	-	-
DX ³ 50 kA C and D curves	≤ 4 to 63 A	-	-	-	-	-	-	-	-	-	

TT or TN neutral earthing systems: for a 230/400 V supply in order to determine the breaking capacity of a 2 P MCB used as L + N (230 V) downstream a 2 P or 4 P circuit breaker use values indicated in the table for 230/240 V

	DPX 250 ER			DPX 250	DPX-H 250	DPX 630	DPX-H 630	DPX 1250 and 1600 + DPX-H 1250 and 1600
	25 kA 100 to 250 A	36 kA 100 to 250 A	50 kA 100 to 250 A	36 kA 40 to 250 A	70 kA 40 to 250 A	36 kA 160 to 630 A	70 kA 160 to 630 A	50 kA and 70 kA 630 to 1600 A
	25 kA	25 kA	25 kA	25 kA	25 kA	25 kA	25 kA	25 kA
	25 kA	25 kA	25 kA	25 kA	25 kA	25 kA	25 kA	20 kA
	25 kA	25 kA	25 kA	25 kA	25 kA	25 kA	25 kA	15 kA
	25 kA	25 kA	25 kA	25 kA	25 kA	20 kA	20 kA	15 kA
	25 kA	25 kA	25 kA	25 kA	25 kA	16 kA	16 kA	12,5 kA
	20 kA	20 kA	20 kA	20 kA	20 kA	16 kA	16 kA	12,5 kA
	25 kA	25 kA	25 kA	25 kA	25 kA	25 kA	25 kA	25 kA
	25 kA	25 kA	25 kA	25 kA	25 kA	25 kA	25 kA	20 kA
	25 kA	25 kA	25 kA	25 kA	25 kA	25 kA	25 kA	16 kA
	25 kA	25 kA	25 kA	25 kA	25 kA	20 kA	20 kA	16 kA
	25 kA	25 kA	25 kA	25 kA	25 kA	20 kA	20 kA	16 kA
	20 kA	20 kA	20 kA	20 kA	20 kA	20 kA	20 kA	16 kA
	20 kA	20 kA	20 kA	20 kA	20 kA	20 kA	20 kA	16 kA
	20 kA	20 kA	20 kA	16 kA	16 kA	16 kA	16 kA	16 kA
	-	30 kA	30 kA	30 kA	30 kA	30 kA	30 kA	30 kA
	-	30 kA	30 kA	36 kA	36 kA	36 kA	36 kA	36 kA
	-	30 kA	30 kA	36 kA	36 kA	36 kA	36 kA	36 kA
	-	30 kA	30 kA	36 kA	36 kA	30 kA	30 kA	30 kA
	-	30 kA	30 kA	30 kA	30 kA	30 kA	30 kA	30 kA
	-	30 kA	30 kA	36 kA	36 kA	36 kA	36 kA	36 kA
	-	-	50 kA	-	50 kA	-	50 kA	50 kA
	-	-	50 kA	-	50 kA	-	50 kA	50 kA
	-	-	50 kA	-	50 kA	-	36 kA	36 kA
	-	-	-	-	70 kA	-	70 kA	70 kA

	DPX 160			DPX 250 ER			DPX 250	DPX-H 250	DPX 630	DPX-H 630	DPX 1250 and 1600 + DPX-H 1250 and 1600
	25 kA 63 to 160 A	36 kA 63 to 160 A	50 kA 40 to 160 A	25 kA 100 to 250 A	36 kA 100 to 250 A	50 kA 100 to 250 A	36 kA 40 to 250 A	70 kA 40 to 250 A	36 kA 160 to 630 A	70 kA 160 to 630 A	50 kA + 70 kA 630 to 1600 A
	40 kA	50 kA	50 kA	40 kA	50 kA	50 kA	50 kA	50 kA	50 kA	50 kA	50 kA
	40 kA	50 kA	50 kA	40 kA	50 kA	50 kA	50 kA	50 kA	50 kA	50 kA	50 kA
	36 kA	36 kA	36 kA	36 kA	36 kA	36 kA	50 kA	50 kA	30 kA	30 kA	25 kA
	30 kA	30 kA	30 kA	30 kA	30 kA	30 kA	50 kA	50 kA	30 kA	30 kA	25 kA
	40 kA	50 kA	50 kA	40 kA	50 kA	50 kA	50 kA	50 kA	50 kA	50 kA	50 kA
	40 kA	50 kA	50 kA	40 kA	50 kA	50 kA	50 kA	50 kA	50 kA	50 kA	50 kA
	36 kA	36 kA	36 kA	36 kA	36 kA	36 kA	50 kA	50 kA	36 kA	36 kA	36 kA
	36 kA	36 kA	36 kA	36 kA	36 kA	36 kA	50 kA	50 kA	32 kA	32 kA	32 kA
	-	-	55 kA	-	-	55 kA	55 kA	60 kA	55 kA	60 kA	50 kA
	-	-	55 kA	-	-	55 kA	55 kA	60 kA	55 kA	60 kA	50 kA
	-	-	55 kA	-	-	55 kA	55 kA	60 kA	55 kA	60 kA	50 kA
	-	-	55 kA	-	-	55 kA	55 kA	60 kA	55 kA	60 kA	50 kA
	-	-	-	-	-	-	-	75 kA	-	75 kA	75 kA
	-	-	-	-	-	-	-	75 kA	-	75 kA	75 kA
	-	-	-	-	-	-	-	75 kA	-	75 kA	75 kA
	-	-	-	-	-	-	-	120 kA	-	120 kA	120 kA

Protection of DC circuits

Protection of DC circuits

DX³ 6000 and DX³ 10000 MCBs (1P/2P/3P/4P - I_n ≤ 63 A) designed for use in 230/400 V_~ supplies, can also be used in DC circuits. In this case, the following deratings and precautions must be taken into account

1 - Protection against short-circuits

Max. magnetic tripping threshold: multiplied by 1.4
 Example: For a C curve MCB for which the AC tripping threshold is between 5 and 10 I_n, the DC tripping threshold will be between 7 and 14 I_n

2 - Protection against overloads

The time/current thermal tripping curve is the same as for AC

3 - Operating voltage

Max. operating voltage: 80 V per pole (60 V for single-pole + N MCBs)
 For voltages higher than this value, several poles must be wired in series

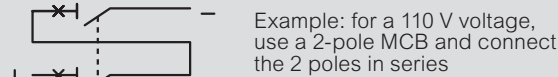

4 - Breaking capacity

4000 A for a single pole MCB at max. voltage (80 V_~ per pole)

For other voltages, the breaking capacities are as follows:

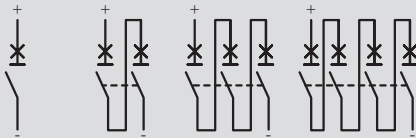

DX ³ 6000	voltage	single-pole	2P	3P	4P
Acc. to IEC 60947.2	≤ 48 V	6 kA	6 kA		
	110 V		6 kA	6 kA	
	230 V				10 kA
Ics ⁽¹⁾	≤ 48 V	100 %	100 %		
	110 V		100 %	100 %	
	230 V				100 %

DX ³ 10000	voltage	single-pole	2P	3P	4P
Acc. to IEC 60947.2	≤ 48 V	10 kA	10 kA		
	110 V		10 kA	10 kA	
	230 V				15 kA
Ics ⁽¹⁾	≤ 48 V	100 %	100 %		
	110 V		100 %	100 %	
	230 V				100 %

1: As a % of I_{cu}

5 - Distribution of breaking poles

To choose the MCB and determine the pole distribution necessary for breaking on each of the polarities, it is necessary to know how the installation is earthed

• Supply with one polarity earthed:

Place all the poles necessary for breaking on the other polarity. If isolation is required, an additional pole must be added on the earthed polarity

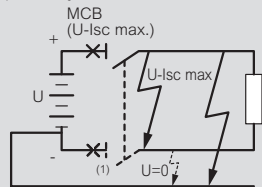

1: Only if isolation required

Example: circuit earthed via the negative polarity / U = 110 V_~ / I_{sc} = 10 kA / I_n = 32 A

Protect the positive polarity using an MCB capable of breaking 10 kA at 110 V (DX³ 10000 2P 32 A with 2 poles on the positive polarity)
 For isolation, use a DX³ 10000 3P 32 A with 2 poles on the positive polarity and one pole on the negative polarity

DX ³ 10000	voltage	single-pole	2P	3P	4P
Acc. to IEC 60947.2	≤ 48 V	10 kA	10 kA		
	110 V		10 kA	10 kA	
	230 V				15 kA

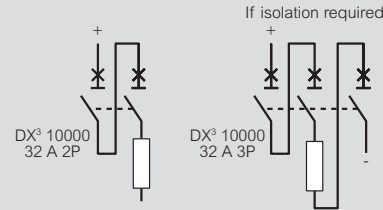

• Network earthed via a middle point:

Place on each polarity the number of poles necessary for max. I_{sc} breaking at half voltage

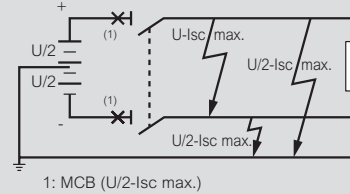

Example: circuit earthed via a middle point / U = 230 V_~ / I_{sc} = 6 kA / I_n = 10 A

Protect each polarity using an MCB capable of breaking 6 kA at half voltage, i.e. 115 V (DX³ 6000 4P 10 A with 2 poles on each polarity)

DX ³ 6000	voltage	single-pole	2P	3P	4P
Acc. to IEC 60947.2	≤ 48 V	6 kA	6 kA		
	110 V		6 kA	6 kA	
	230 V				10 kA

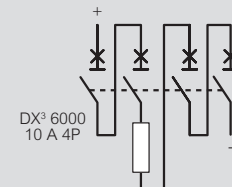

• Isolated earth supply:

Distribute the poles necessary for breaking over the 2 polarities to provide protection in the event of a double earth fault (particularly if there are a number of circuits in parallel)

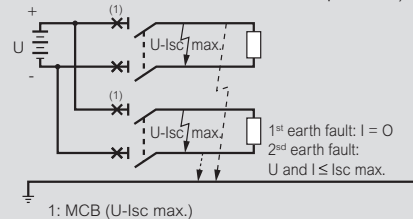

Example: isolated earth circuit / U = 48 V_~ / I_{sc} = 4,5 kA / I_n = 40 A
 Protect the installation with an MCB capable of breaking 4.5 kA at 48 V and protect each polarity (DX³ 6000 MCB 2P 40 A with one pole on each polarity)

DX ³ 6000	voltage	single-pole	2P	3P	4P
Acc. to IEC 60947.2	≤ 48 V	6 kA	6 kA		
	110 V		6 kA	6 kA	
	230 V				10 kA

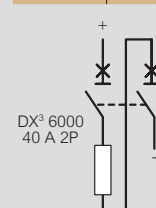

Power contactors CX³ with handle

from 16 A to 63 A



4 125 44



4 125 56

Dimensions **see e-catalogue**
 Technical characteristics **p. 51**

Conform to IEC/EN 61095

Space for power supply busbar on top (up to 25 A)

Pack	Cat.Nos	Power contactors with 24 V~ coil and handle			
		Manual override for test and repair function, carried out via the handle Permanent "ON" or "OFF" without automatic reset			
		2-pole - 250 V~			
1	4 125 14	I max 25 A		Type of contact 2 N/O	Number of modules 1
1	4 125 15 ¹	40 A		2 N/O	2
1	4 125 16 ¹	63 A		2 N/O	2
		4-pole - 400 V~			
1	4 125 17	25 A		4 N/O	2
1	4 125 18 ¹	40 A		4 N/O	3
1	4 125 19 ¹	63 A		4 N/O	3
		Low noise power contactors with 230 V~ coil and handle			
		2-pole - 250 V~			
1	4 125 58	I max 25 A		Type of contact 2 N/O	Number of modules 1
1	4 125 59 ¹	40 A		2 N/O	2
1	4 125 60 ¹	63 A		2 N/O	2
		4-pole - 400 V~			
1	4 125 61	25 A		4 N/O	1
1	4 125 62 ¹	40 A		4 N/O	2
1	4 125 63 ¹	63 A		4 N/O	2

Pack	Cat.Nos	Power contactors with 230 V~ coil and handle			
		Manual override for test and repair function, carried out via the handle Permanent "ON" or "OFF" without automatic closing of the contactor			
		2-pole - 250 V~			
4	4 125 44	I max 25 A		Type of contact 2 N/O	Number of modules 1
1	4 125 45 ¹	40 A		2 N/O	2
1	4 125 47 ¹	63 A		2 N/O	2
1	4 125 48 ¹	63 A		2 N/C	2
		3-pole 400 V~			
1	4 125 49 ¹	40 A		3 N/O	3
1	4 125 50 ¹	63 A		3 N/O	3
		4-pole 400 V~			
2	4 125 51	25 A		4 N/O	2
1	4 125 53 ¹	40 A		4 N/O	3
1	4 125 56 ¹	63 A		4 N/O	3
1	4 125 57 ¹	63 A		4 N/C	3

1: Handle can be accessed after removing blanking plate

Power contactors CX³ without handle

from 16 A to 63 A



4 125 05



4 125 35

Dimensions **see e-catalogue**
Technical characteristics **p. 51**

Conform to IEC/EN 61095
Space for power supply busbar on top (up to 25 A)

Pack	Cat.Nos	Power contactors with 24 V~ coil			
1	4 125 03	2-pole - 250 V~			
		I max 16 A	Connection 	Type of contact N/C + N/O	Number of modules 1
1	4 125 05	25 A		2 N/O	1
1	4 125 10	4-pole - 400 V~			
		25 A		4 N/O	2
1	4 125 09	25 A		2 N/C + 2 N/O	2

Pack	Cat.Nos	Power contactors with 230 V~ coil			
4	4 125 21	2-pole - 250 V~			
		I max 16 A	Connection 	Type of contact N/C + N/O	Number of modules 1
10 1	4 125 23 4 125 27	25 A		2 N/O	1
		63 A		2 N/O	2
1	4 125 24	25 A		2 N/C	1
5 1	4 125 35 4 125 41	4-pole - 400 V~			
		25 A 63 A		4 N/O 4 N/O	2 3
1	4 125 36	25 A		4 N/C	2
1	4 125 33	25 A		2 N/C + 2 N/O	2

Auxiliaries for contactors CX³



4 124 29



4 124 31

Pack	Cat.Nos	Signalling auxiliaries for contactors			
1	4 124 29	Auxiliary changeover switch Used to signal the position status of the contacts on the product to which it is connected			
		For 1 module contactors 16 A to 25 A Maximum 2 auxiliary devices per contactor Fitted on left-hand side of contactor			
		I max 5 A	Voltage 250 V~	Contact N/C + N/O	Number of modules 0.5
1	4 124 30	For 2 module contactors 25 A Maximum 2 auxiliary devices per contactor Fitted on left-hand side of contactor			
		5 A	250 V~	N/C + N/O	0.5
1	4 124 31	For 40 and 63 A contactors Maximum 1 auxiliary device per contactor Fitted on left-hand side of contactor			
		5 A	250 V~	N/C + N/O	0.5

For detailed dimensions,
see e-catalogue



Power contactors CX³

Technical characteristics

- Rated impulse withstand voltage (Uimp): 4 kV
- Mechanical endurance (no. of operating cycles): 10⁶ cycles
- Operating temperatures: - 25 °C to + 40 °C
- Storage temperatures: - 40 °C to + 70 °C

Contactor protection against short circuits according to standard EN 61095, conditional short-circuit current:

- I_q = 6 kA for 16 to 25 A contactors

- I_q = 3 kA for 40 to 63 A contactors

Circle breaker or gG fuse rated:

- ≤ 16 A for 16 A rating ≤ 40 A for 40 A rating
- ≤ 25 A for 25 A rating ≤ 63 A for 63 A rating

Consumption of a contactor control coil

16 A and 25 A power contactors					
Coil voltage	24 V~		230 V~ low noise	230 V~	
Current	16 A and 25 A	25 A	25 A	16 A and 25 A	16 A and 25 A
Type of contact	NC + NO 2 NO	4 NO	2 NO	NC + NO 2 NO 2 NC	2 NC + 2 NO 4 NO 4 NC
Dimensions	1 mod.	2 mod.	1 mod.	1 mod.	2 mod.
Holding current	200 mA	300 mA	12 mA	20 mA	20 mA
Inrush current	970 mA	2500 mA	60 mA	90 mA	200 mA

40 A and 63 A power contactors				
Coil voltage	24 V~		230 V~	
Current	40 A and 63 A	40 A and 63 A	40 A and 63 A	40 A and 63 A
Type of contact	2 NO	4 NO	2 NO 2 NC	3 NO 4 NO 4 NC
Dimensions	2 mod.	3 mod.	2 mod.	3 mod.
Holding current	250 mA	270 mA	15 mA	30 mA
Inrush current	1750 mA	1500 mA	150 mA	200 mA

Recommendations

Insert a spacing module (Cat.No 4 063 07 p. 40):

- every two contactors when the ambient temperature is below 40 °C

- every contactor when the ambient temperature is between 40 and 60 °C

Contactor rating	40 °C	50 °C	60 °C
I _e = 16 A	16 A	14 A	12 A
I _e = 25 A	25 A	22 A	20 A
I _e = 40 A	40 A	36 A	32 A
I _e = 63 A	63 A	57 A	50 A

Max. connection cross-section in mm²

Conductor type	Ratings ≤ 25 A	Ratings 40 & 63 A
Rigid	6 ² or 2 x 2.5 ²	25 ² or 2 x 10 ²
Flexible	6 ² or 2 x 2.5 ²	25 ² or 2 x 10 ²
Flexible with single end cap	6 ²	16 ²
Flexible with double end cap	2 x 4 ²	2 x 16 ²

Contactor selection charts

Incandescent lamps

Tungsten and halogen filaments 230 V~								
Nominal wattage	40 W	60 W	75 W	100 W	150 W	200 W	500 W	1000 W
16 A	45	30	24	19	13	10	4	2
25 A	60	48	38	30	20	15	6	3
40 A	96	77	61	48	32	24	10	5
63 A	154	123	97	77	51	38	15	8

ELV halogen bulbs with ferromagnetic ballast						ELV halogen bulbs with electronic ballast						
Nominal wattage	20 W	35 W	50 W	75 W	100 W	150 W	20 W	35 W	50 W	75 W	100 W	150 W
16 A	32	20	15	12	9	6	60	40	28	18	14	9
25 A	52	30	24	16	12	8	80	50	40	26	20	13
40 A	68	39	31	21	16	10	112	70	56	36	28	18
63 A	88	51	41	27	20	14	157	98	78	51	39	25

Contactor selection charts (continued)

Fluorescent tubes with ferromagnetic ballast

Nominal wattage	Single parallel compensated fluorescent					Double series compensated fluorescent				
	18 W	20 W	36 W	58 W	115 W	2 x 20 W	2 x 36 W	2 x 40 W	2 x 58 W	2 x 140 W
16 A	24	24	16	11	5	30	24	22	15	6
25 A	33	30	25	17	9	45	38	35	24	10
40 A	43	39	33	22	12	68	57	53	36	15
63 A	56	51	42	29	15	101	86	79	54	23

Nominal wattage	Quadruple series compensated fluorescent				Compact fluorescent with built-in starter			
	4 x 18 W				7 W	10 W	18 W	26 W
16 A	16				50	40	28	19
25 A	24				60	50	42	28
40 A	36				78	65	55	36
63 A	54				101	85	71	47

Fluorescent tubes with electronic ballast

Nominal wattage	Single fluorescent				Double fluorescent		
	18 W	30 W	36 W	58 W	2 x 18 W	2 x 36 W	2 x 58 W
16 A	72	42	36	22	36	20	12
25 A	110	68	58	36	56	30	19
40 A	165	102	87	54	84	45	29
63 A	248	153	131	81	126	68	43

Nominal wattage	Triple fluorescent (series compensated)		Quadruple fluorescent (series compensated)	
	3 x 14 W	3 x 18 W	4 x 14 W	4 x 18 W
16 A	34	26	26	20
25 A	46	38	37	28
40 A	62	51	52	39
63 A	84	69	73	55

Compact fluorescent with built-in electronic power supply					
Nominal wattage	7 W	11 W	15 W	20 W	23 W
16 A	120	80	64	50	43
25 A	200	125	90	70	60
40 A	280	175	126	98	84
63 A	392	245	176	137	118

Discharge lamps with compensation

Nominal wattage	Metal halogenide						Low pressure sodium vapour					
	35 W	70 W	100 W	150 W	250 W	400 W	18 W	35 W	55 W	90 W	135 W	180 W
16 A	10	6	5	3	2	1	12	6	5	3	2	2
25 A	15	9	7	5	3	2	20	10	7	5	3	3
40 A	23	14	11	8	5	3	30	15	11	8	5	5
63 A	34	20	16	11	7	5	45	23	16	11	7	7

Nominal wattage	High pressure sodium vapour					High pressure mercury vapour				
	70 W	150 W	250 W	400 W	1000 W	50 W	80 W	125 W	250 W	400 W
16 A	8	7	5	3	1	11	8	6	3	2
25 A	10	9	6	4	2	15	10	8	4	3
40 A	15	14	9	6	3	21	14	11	6	4
63 A	23	20	14	9	5	29	20	16	8	6

Nominal wattage	High pressure mixed			
	100 W	160 W	250 W	400 W
16 A	9	6	4	2
25 A	11	7	5	3
40 A	14	9	7	4
63 A	19	12	8	5

Pulse operated latching relays



Dimensions **see e-catalogue**

Pack	Cat.Nos	Noiseless pulse operated latching relay			
1	4 124 00	Conform to standard EN 60669-2-2 Single pole - 16 A - 250 V\sim Control voltage: 230 V Type of contact: 1 N/O Connection: Number of modules: 1			
1	4 124 01	Conform to standard EN 60669-2-2 Delayed noiseless pulse operated latching relay Single pole - 16 A - 250 V\sim Control voltage: 230 V Type of contact: 1 N/O Connection: Number of modules: 1			
1	4 124 04	Conform to standard EN 60669-2-2 Maximum 2 auxiliary devices per latching relay Standard pulse operated latching relays Single pole - 16 A - 250 V\sim Control voltage: 12 V Type of contact: 1 N/O Connection: Number of modules: 1			
1	4 124 05	Control voltage: 24 V Type of contact: 1 N/O Connection: Number of modules: 1			
10	4 124 08	Control voltage: 230 V Type of contact: 1 N/O Connection: Number of modules: 1			
1	4 124 10	2-pole - 16 A - 250 V\sim Control voltage: 24 V Type of contact: 2 N/O Connection: Number of modules: 1			
1	4 124 11	Control voltage: 48 V Type of contact: 2 N/O Connection: Number of modules: 1			
1	4 124 12	Control voltage: 230 V Type of contact: 2 N/O Connection: Number of modules: 1			
1	4 124 14	4-pole - 16 A - 250 V\sim Can be used for 3-pole assembly Control voltage: 24 V Type of contact: 4 N/O Connection: Number of modules: 2			
1	4 124 16	Control voltage: 230 V Type of contact: 4 N/O Connection: Number of modules: 2			
10	0 491 20	Surface mounting pulse operated latching relays 10 A - 230 V \sim - 50/60 Hz Suitable for new installations or retrofitting of existing ones Compatible with electronic ballasts and fluocompact lamps Mounting on plate or in flush-mounting boxes \varnothing 67 mm Equipped with automatic terminals for flexible or rigid wires (max. 2.5 mm) Power : min. 7 W / max. 2300 W IP 20 - IK 04 Dimensions: 49 x 46 x 26 mm Maximum current when used with illuminated push-buttons : 50 mA Noiseless Single pole Single pole with timer Enables energy savings by switching off lighting after a specified period Time delay adjustment from 1 to 60 min. Switch-off pre-warning function (can be disabled)			
10	0 491 21	Single pole with timer Enables energy savings by switching off lighting after a specified period Time delay adjustment from 1 to 60 min. Switch-off pre-warning function (can be disabled)			

Pack	Cat.Nos	Signalling auxiliary			
1	4 124 29	Fitted on left-hand side of latching relay (equipped or not with control auxiliary) Maximum 2 auxiliaries per latching relay Used to signal the status of the contacts on the associated product Auxiliary changeover switch I max.: 5 A Voltage: 250 V \sim Contact: N/C + N/O Number of modules: 0.5			
1	4 124 33	Control auxiliary Fitted on left-hand side of latching relay Maximum 1 control auxiliary per latching relay Compatible with signalling auxiliary Cat.No 4 124 29 Auxiliary device for centralized control For a centralized control of different latching relays from one single point For latching relays 24 V \sim to 48 V \sim Number of modules: 0.5			
1	4 124 34	For latching relays 230 V \sim Number of modules: 0.5			
1	4 124 36	Auxiliary device for general centralized control For simultaneous control of different groups of latching relays, already fitted with auxiliary device for centralised control 230 V \sim Cat.No 4 124 34 Number of modules: 1			
1	4 124 37	Auxiliary device for maintained contact Allows the control of a latching relay via one maintained contact (i.e. time switches) Number of modules: 0.5			
1	4 124 39	Compensator module Used to control 230 V \sim - 50 Hz pulse operated latching relays via illuminated push-buttons without malfunctions Connects to the terminals of the pulse operated latching relay coil Compensation: - 1 compensator module for a total consumption of 3 to 6 mA (example: 6 to 11 illuminated push-buttons consuming 0.55 mA each) - 2 compensators modules for a total consumption of 6 to 9 mA (example: 12 to 17 illuminated push-buttons with consuming 0.5 mA each) Impedance compensator for 230 V \sim pulse operated latching relays Number of modules: 1			

Pulse operated latching relays

Schemas

Signalling with auxiliary Cat.No 4 124 29

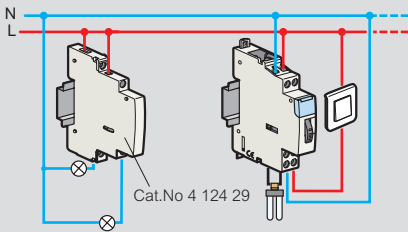

Centralized control at one point using auxiliary devices Cat.Nos 4 124 34 and 4 124 36

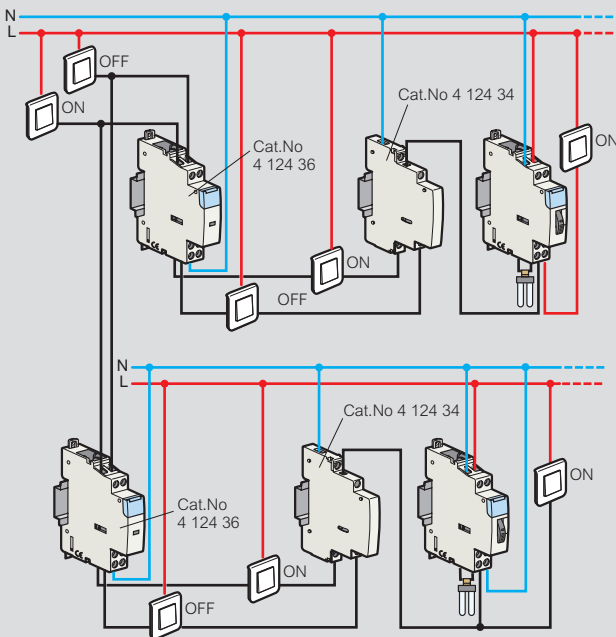

Use only non illuminated push-buttons

Control via maintained contact using auxiliary device Cat.No 4 124 37 and time switch

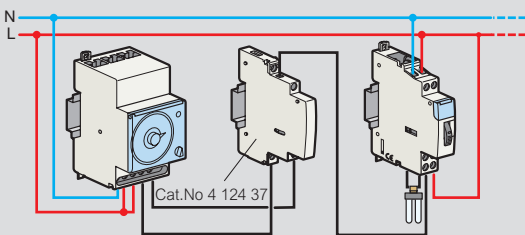

Technical characteristics

Power consumption

Cat.Nos	4 124 00 4 124 01	4 124 04	4 124 05 4 124 10	4 124 14	4 124 11	4 124 08 4 124 12	4 124 16
Control voltage	230 V~	12 V~	24 V~	24 V~	48 V~	230 V~	230 V~
Nominal current	16 A	16 A	16 A	16 A	16 A	16 A	16 A
Connection	1 N/O	1 N/O	1 N/O 2 N/O	4 N/O	2 N/O	1 N/O 2 N/O	4 N/O
Number of modules	1	1	1	1	1	1	2
Holding	-	670 mA	280 mA	570 mA	170 mA	30 mA	50 mA
Inrush	-	2500 mA	1200 mA	2500 mA	700 mA	130 mA	250 mA

Connection cross section mm²

Type of conductors	Cross section
Rigid	1 x 6 mm ² or 2 x 2,5 mm ²
Flexible	1 x 6 mm ² or 2 x 2,5 mm ²
Flexible with single ferrule	6 mm ²
Flexible with double ferrule	2 x 4 mm ²

Cross reference list old range/new range

Old range Cat.No	New range Cat.No	Designation
041 60	4 124 04	16 A - 12 V - 1 N/O
041 61	4 124 05	16 A - 24 V - 1 N/O
041 62	4 124 08	16 A - 230 V - 1 N/O
041 65	4 124 10	16 A - 24 V - 2 N/O
041 66	4 124 11	16 A - 48 V - 2 N/O
041 68	4 124 12	16 A - 230 V - 2 N/O
041 71	4 124 16	16 A - 230 V - 4 N/O
041 85	4 124 29	Auxiliary changeover switch
041 86	4 124 33	Auxiliary devices for centralized control 24 V~ - 48 V~
041 87	4 124 34	Auxiliary devices for centralized control 230 V~
041 89	4 124 39	Compensation module
041 88	4 124 36	Auxiliary device for general centralized control
041 84	4 124 37	Auxiliary device for maintained contact

Programmable time switches

with digital display



Dimensions **see e-catalogue**

For switching an electric circuit (lighting, heating) ON or OFF at selected times during a pre-programmed time period Temporary (automatic return) or permanent (forced switching ON or OFF) override on output

Pack	Cat.Nos	Standard - daily or weekly programme with 6 years clock working reserve	Pack	Cat.Nos	Multiple functions annual program
1	0 037 05	<p>Compatible with alternative renewable energy systems such as photovoltaic panels Automatic summer/winter changeover Clock precision: ± 1 sec per day Minimum programme setting: 1 min 28 programmes</p> <p>Power supply 120/230 V\sim - 50/60 Hz 1 output 16 A - 250 V\sim $\mu \cos \phi = 1$ per 1 inverter contact Low consumption: 0.1 W</p>	1	4 126 30	<p>Annual programme High precision clock: ± 0.2 sec per day For programming periods throughout the year 28 programmes per channel possible: - weekly / astronomical programmes - yearly programmes - exceptional programmes Manual override (switch on and off) for every channel on the front of the switch Programmed directly on keypad, or using programme transfer key supplied 2 outputs - 230 V\sim - 50/60 Hz</p>
1	4 126 31	<p>Multiple functions - daily or weekly programme with 6 years clock working reserve Programme settings: on daily or weekly basis 15 languages A programme consists of an on and off time and their assignment to certain days Option to suspend the programme for a specific period to set-up with start and date Minimum programme setting: 1 s. High precision clock: ± 0.1 sec per day Particularly suited to irregular cycles: - security installations (access point, alarms, etc.), - industrial installations (pump stations, etc.) Programmed directly on keypad, or using programme transfer key Cat.No 4 128 72 Additional functions including random (irregular cycles), hour counters</p> <p>Power supply 230 V\sim - 50/60 Hz 1 output 16 A - 250 V\sim 56 programmes $\mu \cos \phi = 1$ per 1 inverter contact 84 impulses max.</p>	2	0 047 70	<p>4 outputs - 120/230 V\sim - 50/60 Hz</p>
1	4 126 41	<p>Power supply 120 V\sim - 50/60 Hz 1 output 16 A - 250 V\sim 56 programmes $\mu \cos \phi = 1$ per 1 inverter contact 84 impulses max.</p>	2	0 047 82	<p>Battery Working reserve 5 years for Cat.No 0 047 70</p>
1	4 126 32	<p>Power supply 24 V\sim - 50/60 Hz 1 output 16 A - 24 V\sim 56 programmes $\mu \cos \phi = 1$ per 1 inverter contact 84 impulses max.</p>	2	4 128 73	<p>Programming software Can be used to create, save and transfer program settings for multifunction and multi-program time switches, Cat.Nos 0 047 70, 4 126 31/32/33/41 and 4 126 54 Data is transferred to the programme transfer key Cat.No 4 128 72, using the data loader connected to the USB port of the PC Kit comprising software on CD-ROM, data loader and transfer key Windows Vista compatible</p>
1	4 126 33	<p>Programming transfer key Can be used to store programme settings made: - Directly on a multifunction and multi-programme time switch Cat.Nos 4 126 31/33/41 (loading on device) - with the programming software installed on a PC running Windows (loading on data loader)</p>	2	4 126 54	<p>For outdoor illuminations Astronomical For autonomous control of outdoor illuminations Automatic programming: simply initialise the products for the location with no need to install a photoelectric cell Programmed directly on keypad, or using programme transfer key Cat.No 4 128 27 High precision clock: ± 0.2 sec per day</p>
1	4 128 72		2	4 126 57	<p>Power supply 230 V\sim - 50/60 Hz 1 output 16 A - 250 V\sim 28 programmes</p>
			2		<p>2 output 16 A - 250 V\sim 2 x 14 programmes</p>

Programmable time switches

with analogue dial

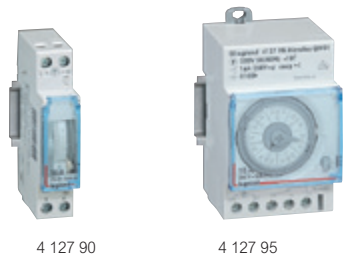

Dimensions [see e-catalogue](#)

Programmed via captive segment
 1-module device: min. 1 segment
 3-module device: min. 2 segments
 Power supply: 230 V \sim - 50/60 Hz
 3-position override switch "ON-AUTO-OFF" on front panel
 Manual changeover to summer/winter time
 1 outlet 16 A - 250 V \sim - μ cos ϕ = 1

Pack	Cat.Nos	Daily programme	Number of modules
		1 segment = 15 minutes Accuracy: \pm 5 minutes	
		Vertical dial Minimum switching time: 15 minutes N/O contact Without working reserve	
1	4 127 80		1
1	4 127 90	With 100 h working reserve	1
		Horizontal dial Minimum switching time: 15 minutes Changeover switch Without working reserve	
1	4 128 12		3
1	4 128 13	With 100 h working reserve	3
		Weekly programme 1 segment = 2 hours Accuracy: \pm 30 minutes	
		Vertical dial Minimum switching time: 2 hours N/O contact With 100 h working reserve	
1	4 127 94		1
		Horizontal dial Minimum switching time: 4 hours Changeover switch With 100 h working reserve	
1	4 127 95		3

Programmable time switches

with analogue and digital dial

Diagrams

Cat.Nos 4 127 80/90/94

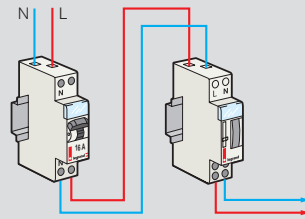

Cat.Nos 4 128 12/13/95

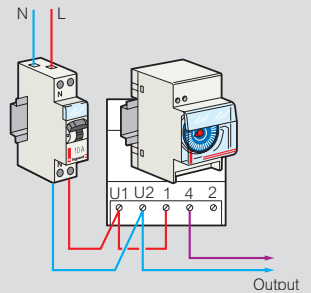

Cat.No 0 047 70

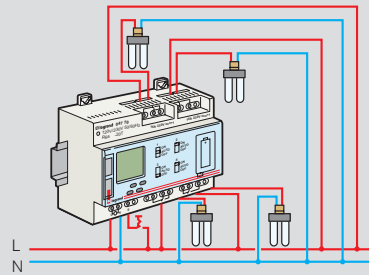

Cat.Nos 4 126 31/32/33

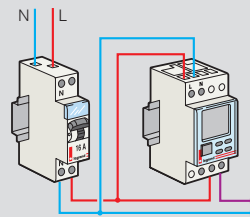

Cat.No 4 126 54

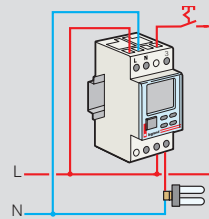

Cat.No 4 126 57

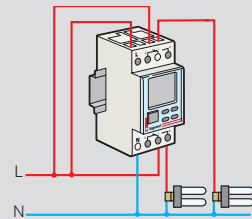

Output closing and breaking times are calculated based on the date, the actual time when the device was switched and on geographical coordinates of the actual location

Technical characteristics

Cat.Nos	Prog. time	Min. programme settings	Working reserve	Summer/winter time	Outputs 16 A	Nb of prog.	Nb of modules
0 037 05	7 d	1 min	6 years	auto	1	28	1
4 126 31	24 h/7 d	1 s	6 years	auto	1	56	2
4 126 32	24 h/7 d	1 s	6 years	auto	1	56	2
4 126 33	24 h/7 d	1 s	6 years	auto	1	56	2
4 126 41	24 h/7 d	1 s	6 years	auto	2	2 x 28	2

Cat.Nos	Programme	Segment	Min. switching time	Working reserve	16 A output via contact		Nb of modules
					N/O	Chang. S.	
4 128 12	24 h	15 min	30 min	without	-	1	3
4 128 13	24 h	15 min	30 min	100 h	-	1	3
4 127 80	24 h	15 min	15 min	without	1	-	1
4 127 90	24 h	15 min	15 min	100 h	1	-	1
4 127 94	7 d	2 h	2 h	100 h	1	-	1
4 127 95	7 d	2 h	4 h	100 h	-	1	3



0 037 05



Space for supply busbar



0 047 04

Dimensions **see e-catalogue**

Designed for supply busbar compatibility
 Power supply: 230 V~ - 50/60 Hz
 Switches a lighting circuit for a specific time
 Self-protection in the event of blocked pushbutton

Pack	Cat.Nos	Time-lag switch	Numbers of modules
10	4 126 02	Resettable 230 V~ - 50/60 Hz Timing adjustable from 0.5 sec to 10 min Manual override contact Output 16 A - 250 V~ - $\mu \cos \phi = 1$ 2000 W incandescent/halogen 2000 W halogen - 230 V~ 1000 VA fluo - series compensated 120 VA fluo - parallel compensated 14 μF 100 VA compact fluorescent 1000 W energy saving lamp automatic 3-wire or 4-wire connection	1
10	0 047 04	Multi-function time-lag switch Resettable 230 V~ - 50/60 Hz Timing adjustable from 0.5 sec to 12 min Operation with 3 or 4 wires automatically recognised by the time-lag switch - Inputs for separate control 8-230 V (presence detection, lighting control by door entry system etc.) - Switch-off pre-warning function, display of time-lag end - Long duration function (1 hour) and manual switch-off Output 16 A - 250 V~ - $\mu \cos \phi = 1$ 3680 W incandescent/halogen 2000 W halogen 230 V~ 1000 VA fluo - parallel compensated $\leq 100 \mu\text{F}$ 2000 VA compact fluorescent 500 W halogen lamp + ferromagnetic transformer 2000 W halogen lamp + electronic transformer - Specially suited to energy saving lamps 1000 W energy saving lamp	1
1	0 497 83	Automatic staircase time-lag switch for wall mounting 230 V - 50 Hz Switches a lighting circuit during a determined period Controlled by illuminated push-button 50 mA max 3 wire connection Output : 1 contact Contact rating 10 A - 250 V~ - $\cos \phi = 1$ Type of delay adjustable Type Electronic Resettable 0.5 to 10 min.	

Multi-function time-lag switch

4-wire

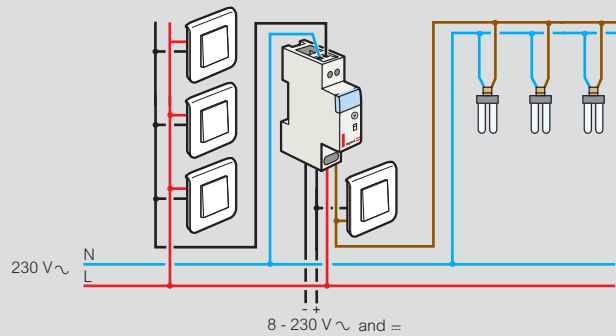

3-wire

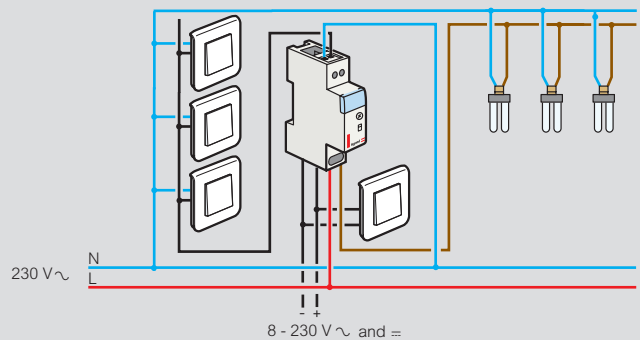

Multi-function time-lag switch: lighting control by door entry system

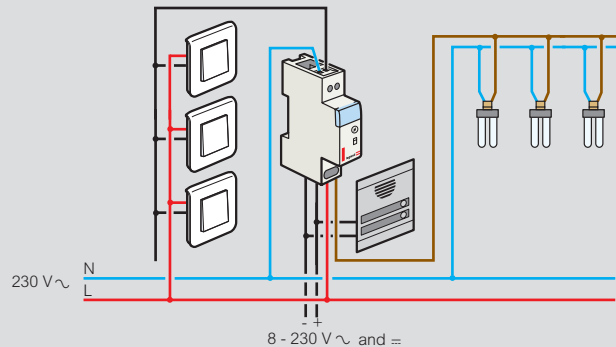

Switch-off pre-warning function

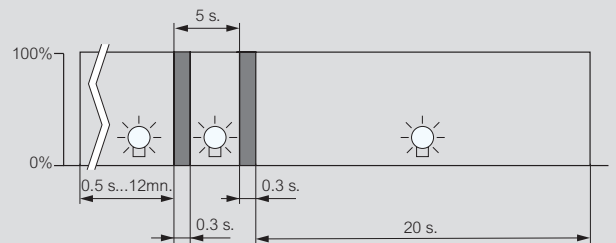

For fluorescent and energy saving lamps the switch-off period is longer than 0.3 s, because of re-starting time required by the lamps

Light sensitive switches



Light sensitive switches

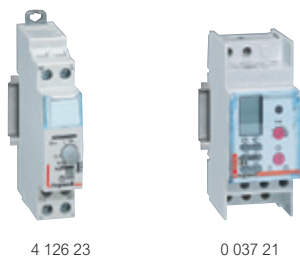

4 126 23

0 037 21

Dimensions **see e-catalogue**

Can be used to switch a lighting circuit "ON" and "OFF" based on light conditions (nightfall, daybreak)
 Supplied with photoelectric cell housed in Plexo weatherproof box
 Power supply: 230 V~ - 50/60 Hz

Pack	Cat.Nos	Standard
1	4 126 23	Output 16 A - 250 V~ - $\mu \cos \phi = 1$ 2000 W incandescent 2000 W series compensated fluorescent 1000 W parallel compensated fluorescent 70 μ F 1000 W energy-saving bulb 2000 W halogen bulb + ferromagnetic transformer 2000 W halogen bulb + electronic transformer Automatic timer response Adjustable from 1 to 100 000 lux Number of modules: 1 Supplied with photoelectric cell Cat.No. 4 128 58
1	4 128 58	Replacement photoelectric cell for use with standard light sensitive switch Cat.No. 4 126 23 - IP 55 - IK07
1	0 037 21	Programmable with weekly time switch Output 10 A - 250 V~ - $\mu \cos \phi = 1$ 1000 W incandescent 2000 VA fluo serie compensated Timer response: 60 sec Adjustable from 2 to 60000 lux 8 possible programmes (off periods during the night)

Numbers of modules
2

Standard light sensitive switch (Cat.No 4 126 23)

Switch "ON" and "OFF" defined by a light level threshold

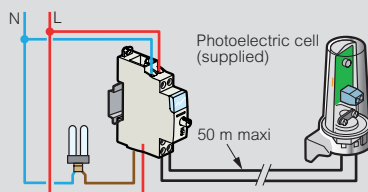

Programmable light sensitive switch (Cat.No 0 037 21)

Controls lighting according to the time and light level
 Minimum switching interval: 1 minute
 Working reserve: 100 hrs
 Manual switch: override/programme/stop
 Automatic changeover to summer/winter time
 Temporary override with automatic return to programme

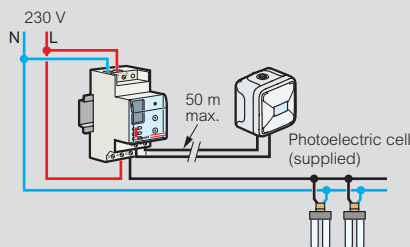

EMDX³ electrical energy meters

┌ rail mounting



0 046 70

0 046 74

Technical characteristics p. 61

Measure the electricity consumed by a single-phase or three-phase circuit downstream of the electricity distribution metering. Display electricity consumption in kWh, as well as other values such as current, active energy, reactive energy and power (depending on the catalogue number).

Conform to standards IEC 62053-21/23, IEC 62052-11 and IEC 61010-1. MID compliance ensures accuracy of the metering with a view to recharging for the electricity used.

Pack	Cat.Nos		Single-phase meters
	Non-MID	MID compliant	
1	0 046 70		Direct connection 32 A - 1 module Pulse output
1	0 046 81		36 A - 2 modules Pulse output
1	0 046 72	0 046 78	63 A - 2 modules Pulse output
1	0 046 77	0 046 79	63 A - 2 modules RS 485 output
Three-phase meters			
1	0 046 73	0 046 82	Direct connection 63 A - 4 modules Pulse output
1	0 046 80	0 046 83	63 A - 4 modules RS 485 output
Connection with CT			
1	0 046 74	0 046 85	5 A - 4 modules pulse output
1	0 046 84	0 046 86	5 A - 4 modules RS 485 and pulse output
Concentrator			
1	0 046 87		For collecting and transmitting measurements taken by 7 universal pulse electricity meters. Also collects data from other meters (gas meters, water meters, etc.) RS485 output 4 modules

EMDX³ multi-function measuring units

┌ rail mounting



0 046 76

Technical characteristics p. 61

Conform to standards:

- IEC 61557-12
- IEC 62053-22 class 0.5 S
- IEC 62053-23 class 2

Pack	Cat.Nos	EMDX³ modular
		For mounting on ┌ rail Width: 4 modules • LCD display • Measurement of currents, voltages, active, reactive and apparent power and internal temperature • Dual tariff metering: - Active energy consumed - Reactive energy consumed - Operating time - Power factor • THD voltages and currents up to order 51 • Programmable alarms on all functions • Outputs for controlling wiring devices, alarm feedback and pulse feedback
1	0 046 75	EMDX³ pulse unit Data transmission via pulses
1	0 046 76	EMDX³ RS 485 unit Data transmission via RS 485 communication interface and pulses

EMDX³ multi-function measuring units

for mounting on door or solid faceplate



0 146 68



0 146 69



0 146 73



Current transformers (CT)

p. 60

Technical characteristics p. 61

Conform to standards:

- IEC 61557-12
- IEC 62053-22 class 0.5 S
- IEC 62053-23 class 2

Pack	Cat.Nos	EMDX ³ - Access	Pack	Cat.Nos	EMDX ³ - Premium (continued)
1	0 146 68	Multi-function measuring unit For mounting on door or solid faceplate Dimensions: 96 x 96 x 60 mm • LCD display • Measurement of currents, voltages, active, reactive and apparent power, internal temperature and power factor • Metering: - Active energy consumed or produced - Reactive energy consumed or produced - Operating time - Pulses • THD voltages and currents up to order 51 • Programmable alarms on all functions Can take 2 optional modules	1	0 146 73	Modules for EMDX³ - Premium multi-function measuring units RS 485 communication module MODBUS link
			1	0 146 74	Storage module Storage of active and reactive power over 62 days, the last 10 alarms and the average voltage and frequency values over 60 days max.
			1	0 146 75	Module with 2 inputs/2 outputs Up to 3 modules, i.e. 6 inputs/6 outputs, can be installed Outputs can be assigned to monitoring mode, remote control or timed remote control
1	0 146 71	Modules for EMDX³ - Access multi-function measuring unit RS485 communication module MODBUS link	1	0 146 77	Temperature module Indication of the internal temperature and possibility of connecting 3 sensors for measuring the external temperature
1	0 146 72	1-output module Can be assigned to pulse feedback, alarm feedback or control of wiring devices			Communication and supervision
		EMDX³ - Premium			Web servers Enable remote viewing, via a web browser on PCs, smartphones, web viewers, tablet computers such as iPads, Archos, etc., of values collected on electricity meters and multi-function measuring units
1	0 146 69	Multi-function measuring units For mounting on door or solid faceplate Dimensions: 96 x 96 x 60 mm • LCD display • Measurement of currents, voltages, active, reactive and apparent power, internal temperature and power factor • Metering: - Active energy consumed or produced - Reactive energy consumed or produced - Operating time - Pulses • Individual harmonics up to order 63 • Programmable alarms on all functions Can take 4 optional modules	1	0 261 78	For 32 metering points (meters or multi-function measuring units)
			1	0 261 79	For an unlimited number of metering points (meters or multi-function measuring units)
					Legrand software dedicated to measurement For displaying the values collected from electricity meters or multi-function measuring units on a PC connected to the network
			1	0 261 88	For 32 metering points (supplied on CD)
			1	0 261 89	For an unlimited number of metering points (supplied on CD)
					IP converter For RS485/Ethernet conversion for connecting electricity meters and multi-function measuring units to an IP network



0 047 79

Pack Cat.Nos Single-phase current transformers (CT)

Used with ammeters, electricity meters or multi-function measuring units
Provide a 0 to 5 A current at the secondary, proportional to the primary current
For fixing on plates, EN 60715 rail
Cat.Nos 0 046 31/34/36, or bars
Secondary connected by terminals or lugs
Precision class 1%

For 16 x 12.5 mm bar and Ø21 mm cable

Pack	Cat.Nos	Transformation ratio	Output (VA)
1	0 046 31	50/5	1.25
1	0 046 34	100/5	2.5
1	0 046 36	200/5	5.5

For 20.5 x 12.5 and 30 x 10.5 mm bar and Ø23 mm cable

1	0 047 75	300/5	11
---	----------	-------	----

For 40.5 x 10.5 mm bar and Ø35 mm cable

1	0 046 38	400/5	12
---	----------	-------	----

For 65 x 32 mm bar

1	0 047 76	600/5	12
1	0 047 77	800/5	15
1	0 047 78	1000/5	20

For 84 x 34 mm bar

1	0 047 79	1250/5	15
---	----------	--------	----

For 127 x 38 mm bar

1	0 046 45	1500/5	15
1	0 046 46	2000/5	20

For 127 x 54 mm bar

1	0 047 80	2500/5	50
1	0 046 48	4000/5	50

Three-phase current transformers (CT)

Used with ammeters, electricity meters or multi-function measuring units
Provide a 0 to 5 A current at the secondary, proportional to the primary current
For fixing directly on bars
Secondary connected by terminals or lugs
Precision class 1%

For three 20.5 x 5.5 mm bars

Pack	Cat.Nos	Transformation ratio	Output (VA)
1	0 046 98	250/5	3

For three 30.5 x 5.5 mm bars

1	0 046 99	400/5	4
---	----------	-------	---

Current transformers (CT)

Technical characteristics

Degree of protection: IP 20

Operating frequency: 50/60 Hz

Dimensions

• Single-phase CTs

Cat.Nos 0 046 31/34/36 for 16 x 12.5 mm bar and Ø21 mm cable

Fixing on EN 60715 rail

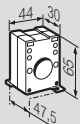

Cat.No 0 047 75 for 20.5 x 12.5 and 30 x 10.5 mm bar and Ø23 mm cable

Cat.No 0 046 38 for 40.5 x 10.5 mm bar and Ø35 mm cable

Fixing on EN 60715 rail or on plate

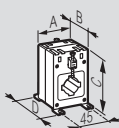

Cat.Nos	A	B	C	D	Ø	Fixing centres on plate
0 047 75	56	42	94	50	23	50 x 45
0 046 38	77	46	107	54	35	54 x 45

Cat.Nos 0 047 76/77/78 for 65 x 32 mm bar

Cat.No 0 047 79 for 84 x 34 mm bar

Fixing on bar

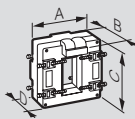

Cat.Nos	A	B	C	D
0 047 76/77/78	90	90	94	40
0 047 79	96	87	116	58

Cat.Nos 0 046 45/46 for 127 x 38 mm bar

Cat.Nos 0 047 80 and 0 046 48 for 127 x 54 mm bar

Fixing on bar

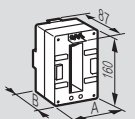

Cat.Nos	A	B
0 046 45/46	99	58
0 046 48/0 047 80	125	40

• Three-phase CT

Cat.No 0 046 98 for three 20.5 x 5.5 mm bars

Cat.No 0 046 99 for three 30.5 x 5.5 mm bars

Fixing on bar

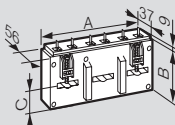

Cat.Nos	A	B	C
0 046 98	107	58.5	25
0 046 99	135	66.5	30

Determination of the max. distance between CT and meter

Cat.Nos	Max. power of CT	Meter consump. (W)	Max. loss in capac. (VA)	Max. distance bet. CT & meter (m)		
				Wiring 2.5 mm ²	Wiring 4 mm ²	Wiring 6 mm ²
0 046 31	1.25	0.5	0.75	1.8	2.7	3.9
0 046 34	2.5	0.5	2	4.9	7.1	10.4
0 046 98	3	0.5	2.5	6.1	8.9	13
0 046 99	4	0.5	3.5	8.5	12.4	18.1
0 046 36	5.5	0.5	5	12.2	17.8	25.9
0 047 75	11	0.5	10.5	25.5	37.3	54.4
0 046 38	12	0.5	11.5	28	40.8	59.6
0 047 77/79	15	0.5	14.5	35.3	51.5	75.2
0 046 45	15	0.5	14.5	35.3	51.5	75.2
0 046 46	20	0.5	19.5	47.4	69.3	101.1
0 047 78	20	0.5	19.5	47.4	69.3	101.1
0 047 80	50	0.5	49.5	120.4	175.8	256.7
0 046 48	50	0.5	49.5	120.4	175.8	256.7

EMDX³ electrical energy meters

└ rail mounting

Technical characteristics

Single-phase meters Cat.Nos 0 046 70/72/77/78/79/81

LCD display: 7 digits
 Resolution: 0.1 kWh
 Maximum indication: 99999.9 kWh
 Metrological LED: 1 Wh/pulse (Cat.No 0 046 70 : 0.5 Wh/pulse)
 Accuracy (EN 62053-21): class 1
 Reference voltage Un: 230 V-240 V
 Reference frequency: 50-60 Hz
 Pulse output: 1 pulse/10 Wh
 (Cat.No 046 70: 2 pulse/Wh)

Three-phase meters Cat.Nos 0 046 73/74/80/82/83/84/85/86

LCD display: 8 digits
 Resolution: 0.01 kWh⁽¹⁾
 Maximum indication: 99999.99 kWh⁽¹⁾
 Metrological LED: 0.1 Wh/pulse or 1 Wh/pulse
 Active energy accuracy (EN 62053-21): class 1
 Reactive energy accuracy (EN 62053-23): class 2
 Reference voltage Un:
 - Single-phase: 230-240 V
 - Three-phase: 230(400)-240(415) V
 Operating limit range (EN 62053-21, EN 62053-23):
 - Single-phase: 110 to 254 V
 - Three-phase: 110(190) to 254(440) V
 Pulse output: 1 pulse/10 Wh

Cat.Nos		0 046 70	0 046 81	0 046 72	0 046 77	0 046 78	0 046 79	0 046 73	0 046 80	0 046 82	0 046 83	0 046 74	0 046 84	0 046 85	0 046 86		
Number of modules		1	2	2	2	2	2	4	4	4	4	4	4	4	4		
Connection	Direct	●	●	●	●	●	●	●	●	●	●	●	●	●	●		
	Via a current transformer											●	●	●	●		
	Single-phase	●	●	●	●	●	●					●	●				
	Three-phase							●	●	●	●	●	●	●	●		
Max. current		32 A	36 A	63 A	63 A	63 A	63 A	63 A	63 A	63 A	63 A	5 A (CT)	5 A (CT)	5 A (CT)	5 A (CT)		
Metering and measurement	Total active energy	●	●	●	●	●	●	●	●	●	●	●	●	●	●		
	Total reactive energy							●	●	●	●	●	●	●	●		
	Partial active energy (reset)		●	●	●	●	●	●	●	●	●	●	●	●	●		
	Partial reactive energy (reset)							●	●	●	●	●	●	●	●		
	Active power			●	●	●	●	●	●	●	●	●	●	●	●		
	Reactive power							●	●	●	●	●	●	●	●		
	Apparent power							●	●	●	●	●	●	●	●		
	Current			●	●	●	●	●	●	●	●	●	●	●	●		
	Voltage			●	●	●	●	●	●	●	●	●	●	●	●		
	Frequency			●	●	●	●	●	●	●	●	●	●	●	●		
	Power factor			●	●	●	●	●	●	●	●	●	●	●	●		
	Time-of-use			●	●												
	Average active power							●	●	●	●	●	●	●	●		
	Max. average active power value							●	●	●	●	●	●	●	●		
Dual tariff							●										
Communication	Pulse output	●	●	●		●	●	●	●	●	●	●	●	●	●		
	RS 485 interface				●	●		●	●		●	●	●	●	●		
MID compliant					●	●				●	●			●	●		
Operating conditions	Reference temperature	23 °C ± 2 °C															
	Operating temperature	-20 to +55 °C				-10 to +45 °C				-5 to +55 °C							
	Storage temperature	-40 to +70 °C				-25 to +70 °C				-25 to +70 °C							
	Consumption	≤ 8 VA				≤ 8 VA				≤ 4 VA per phase				≤ 1 VA per phase			
	Heat dissipation	≤ 6.5 W				≤ 6.5 W				≤ 6 W				≤ 4 W			

Interfacing with IP communication network

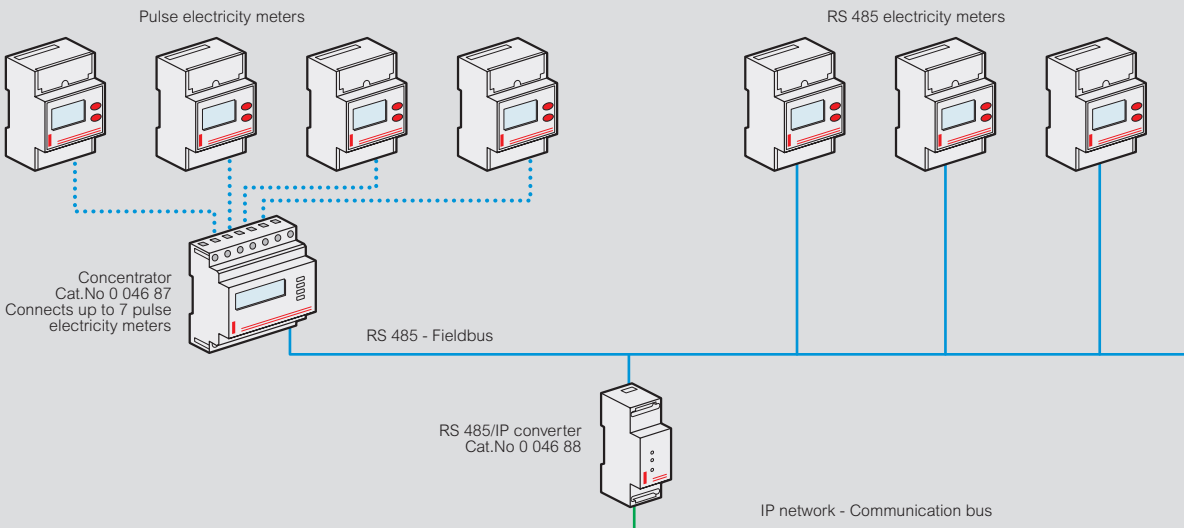

1: For direct connection meters
 If connected via transformers, the resolution and maximum indication depend on the transformation ratios of these transformers

EMDX³ multi-function measuring units

Technical characteristics

Cat.Nos		0 046 75/76	0 146 68	0 146 69	
Connection	Current measurement terminals	4 mm ²	6 mm ²	6 mm ²	
	Other terminals	2.5 mm ²	2.5 mm ²	2.5 mm ²	
Protection index	Front cover	IP 51	IP 52	IP 52	
	Casing	IP 20	IP 30	IP 30	
Weight		205/215 g	400 g	400 g	
Display		Backlit LCD	Backlit LCD	Backlit LCD	
Measurements		3P+N, 3P, 2P, 1P+N	3P+N, 3P, 2P, 1P+N	3P+N, 3P, 2P, 1P+N	
Voltage measurement	Direct	Phase/phase	50 to 520 V~	50 to 500 V~	18 to 700 V~
		Phase/neutral	28 to 300 V~	28 to 289 V~	11 to 404 V~
	From a PT	Primary	-	-	≤ 500 kV
		Secondary	-	-	60, 100, 110, 115, 120, 173, 190 V~
	Permanent overload between phases		760 V~	800 V~	760 V~
	Update period		1 s	1 s	1 s
Current measurement	From a CT	Primary	5 to 9999 A	≤ 9999 A	≤ 9995 A
		Secondary	5 A	5 A	1 or 5 A
	Minimum measurement		5 mA	5 mA	10 mA
	Input consumption		< 0.6 VA	< 0.6 VA	< 0.3 VA
	Display		0 to 9999 A	1 to 11 kA	0 to 11 kA
	Permanent overload		6 A	6 A	10 A
	Intermittent overload		60 A/1 s - 120 A/0.5 s	10 In/1 s	10 In/1 s
	Update period		1 s	1 s	1 s
	Max. CT x PT ratio		-	-	10000000
Power measurement	Total	0 to 9999 kW/kvar/kVA	0 to 11 MW/Mvar/MVA	0 to 8000 MW/Mvar/MVA	
	Update period		1 s	1 s	
Frequency measurement	Measurement range	45.0 to 65.0 Hz	45.0 to 65.0 Hz	45.0 to 65.0 Hz	
	Update period		1 s	1 s	
Auxiliary power supply	50/60 Hz	200 to 277 V~ ±15%	110 to 400 V~ ±10%	110 to 400 V~ ±10%	
	DC	-	120 to 350 V= ±20%	120 to 350 V= ±20%	
	Consumption	< 5 VA	< 10 VA	< 10 VA	
Operating temperature		-10 °C to +55 °C	-10 °C to +55 °C	-10 °C to +55 °C	
Storage temperature		-20 °C to +70 °C	-20 °C to +85 °C	-20 °C to +85 °C	

Flush-mounting dimensions Cat.Nos 0 146 68/69

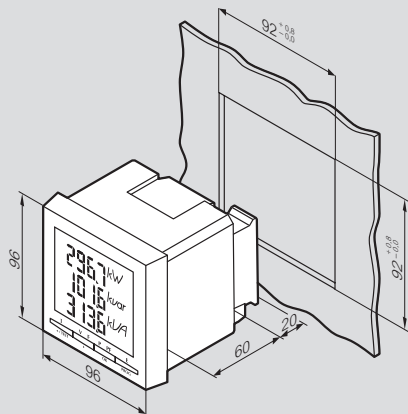

Fixing on door Cat.Nos 0 146 68/69

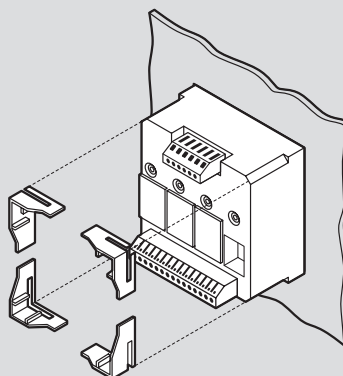

Fitting modules Cat.Nos 0 146 68/69

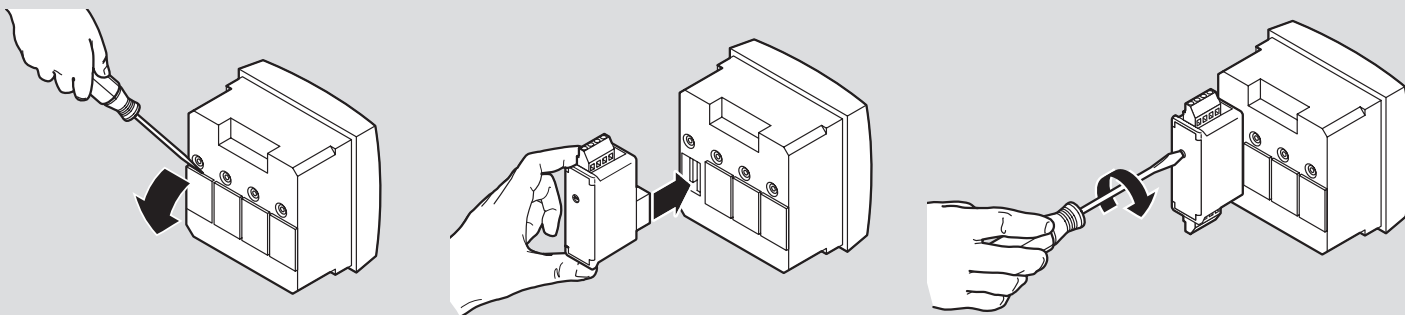

Connection solutions

Unbalanced three-phase network (3 or 4-wire)

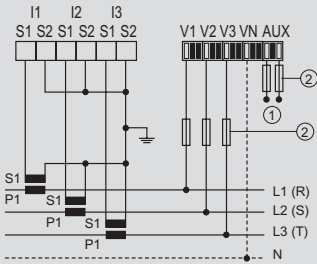

(3-wire)

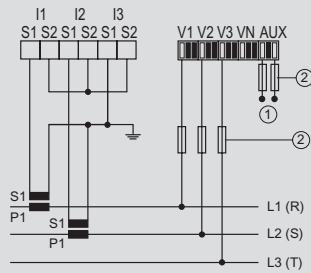
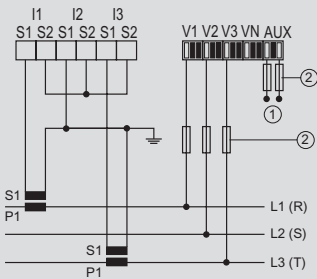

Balanced three-phase network (3 or 4-wire)

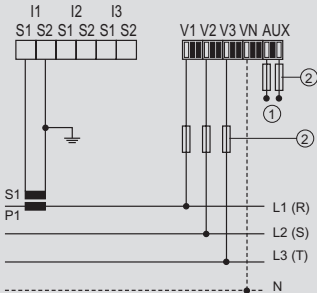

Single-phase network (2-wire)

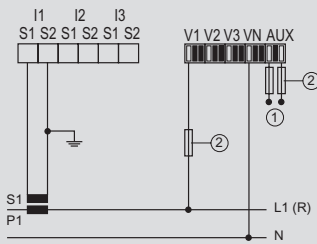

Two-phase network (2-wire)

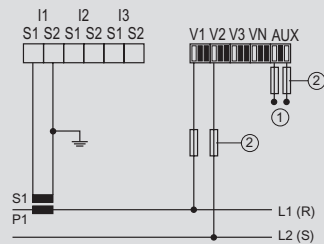

① Auxiliary power supply: 110 ... 400 VAC/120 ... 350 VDC
 ② Fuse: 0.5 A gG/BS 88 2A gG/0.5 A class CC

Wiring example of communication network

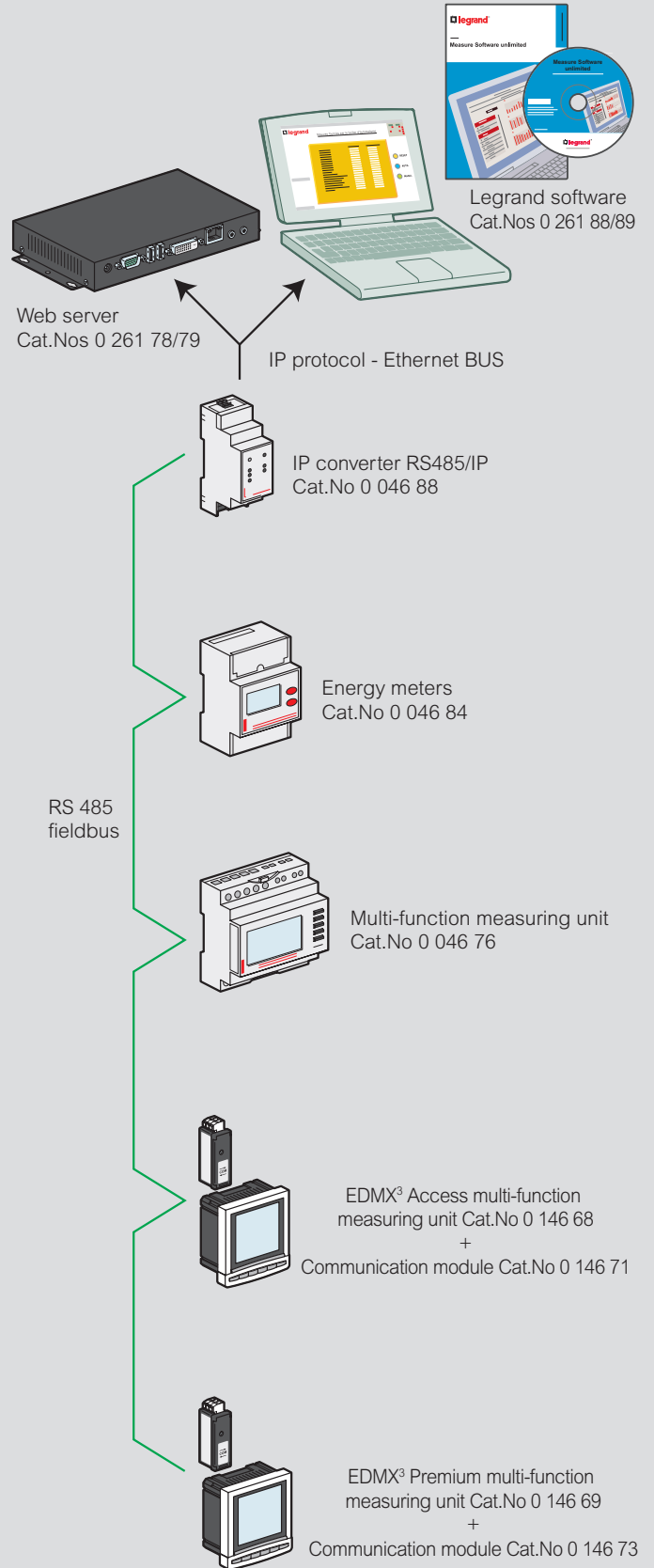

Catalogue number index

Cat.Nos	Page No	Pack	Cat.Nos	Page No	Pack	Cat.Nos	Page No	Pack	Cat.Nos	Page No	Pack	Cat.Nos	Page No	Pack	Cat.Nos	Page No	Pack
	0 037 00		4 062 62	40	1	4 076 25	32	1		4 080 00		4 088 78	34	1	4 092 07	35	1
0 037 05	54	1	66	-	1	26	32	1	4 080 23	33	1				08	-	1
21	57	1	76	-	1	27	32	1	24	-	1				47	-	1
	0 046 00		78	-	1	28	32	1	25	-	1				48	-	1
0 046 31	60	1	80	-	1	29	32	1	27	-	1	4 089 35	34	1	49	-	1
34	-	1	82	-	1	30	32	1	29	-	1	36	-	1	51	-	1
36	-	1	85	-	1	62	32	1	31	-	1	37	-	1	52	-	1
38	-	1	87	-	1	63	32	1	32	-	1	39	-	1	53	-	1
45	-	1	88	41	1	64	32	1	33	-	1	40	-	1	54	-	1
46	-	1	91	40	1	66	32	1	34	-	1	41	-	1	55	-	1
48	-	1	93	-	1	68	32	10	35	-	1	42	-	1	56	-	1
70	58	1	95	-	1	70	32	10	36	-	1	43	-	1	57	-	1
72	-	1				71	32	1	37	-	1	44	-	1	58	-	1
73	-	1	4 063 00			72	32	1	81	-	1	45	-	1	59	-	1
74	-	1	4 063 03	40	2	73	32	1	82	-	1	46	-	1	60	-	1
75	-	1	04	-	2	74	32	1	83	-	1	47	-	1			
76	-	1	05	-	1	75	32	1	85	-	1	48	-	1	4 093 00		
77	-	1	06	-	1	76	32	1	87	-	1	84	-	1	4 093 29	35	1
78	-	1	07	-	10				88	-	1	85	-	1	30	-	1
79	-	1	10	-	1				89	-	1	86	-	1	31	-	1
80	-	1	11	-	1	4 077 00			90	-	1	88	-	1	33	-	1
81	-	1	12	-	2	4 077 93	32	1	91	-	1	89	-	1	34	-	1
82	-	1	13	-	3	94	-	1	92	-	1	89	-	1	35	-	1
83	-	1				96	-	1	93	-	1	90	-	1	36	-	1
84	-	1	4 074 00			98	-	1	94	-	1	91	-	1	37	-	1
85	-	1	4 074 25	32	1				95	-	1	92	-	1	38	-	1
86	-	1	26	-	1	4 078 00						93	-	1	39	-	1
87	-	1	27	-	1	4 078 00	32	1				94	-	1	40	-	1
88	59	1	29	-	1	01	-	1	4 081 00			95	-	1	41	-	1
89	60	1	30	-	1	02	-	1	4 081 43	33	1	96	-	1	42	-	1
98	60	1	32	-	1	03	-	1	45	-	1	97	-	1			
99	-	1	33	-	1	04	-	1	47	-	1				4 097 00		
	0 047 00		34	-	1	05	-	1	48	-	1	4 090 58	34	1	4 097 52	36	1
0 047 04	56	10	35	-	1	06	-	1	49	-	1	59	-	1	53	-	1
70	54	1	36	-	1	07	-	1	50	-	1	60	-	1	54	-	1
75	60	1	37	-	1	08	-	1	51	-	1	62	-	1	55	-	1
76	-	1	38	-	1	09	-	1	52	-	1	63	-	1	56	-	1
77	-	1				10	-	1	53	-	1	64	-	1	57	-	1
78	-	1	4 075 00			11	-	1	54	-	1	65	-	1	58	-	1
79	-	1	4 075 02	32	1	12	-	1	55	-	1	66	-	1	59	-	1
80	-	1	03	-	1	13	-	1	56	-	1	67	-	1	60	-	1
82	54	1	04	-	1	14	-	1	57	-	1	68	-	1	61	-	1
	0 146 00		06	-	1	15	-	1	58	-	1	69	-	1	62	-	1
0 146 68	59	1	07	-	1	16	-	1	59	-	1	70	-	1	63	-	1
69	-	1	09	-	1	17	-	1	60	-	1	71	-	1	64	-	1
71	-	1	10	-	1	18	-	1	61	-	1	72	-	1	65	-	1
72	-	1	11	-	1	19	-	1	62	-	1	73	-	1	66	-	1
73	-	1	12	-	1	20	-	1	63	-	1	74	-	1	67	-	1
74	-	1	13	-	1	21	-	1	64	-	1	75	-	1	68	-	1
75	-	1	14	-	1	22	-	1	65	-	1	76	-	1	69	-	1
77	-	1	15	-	1	24	-	1	66	-	1	77	-	1	70	-	1
	0 227 00		54	-	1	26	-	1	67	-	1				71	-	1
0 227 97	40	1	55	-	1	28	-	1	68	-	1	4 091 07	35	1	72	-	1
	0 261 00		56	-	1	29	-	1	69	-	1	08	-	1	73	-	1
0 261 78	59	1	58	-	1	30	-	1	70	-	1	09	-	1	74	-	1
79	-	1	59	-	1	31	-	1	71	-	1	11	-	1	75	-	1
88	-	1	61	-	1	32	-	1				12	-	1	76	-	1
89	-	1	62	-	1	33	-	1				13	-	1	77	-	1
	0 491 00		63	-	1	34	-	1				14	-	1	78	-	1
0 491 20	52	10	64	-	1	34	33	1				15	-	1	79	-	1
21	-	10	65	-	1	64	-	1				16	-	1	80	-	1
83	56	1	66	-	1	65	-	1				17	-	1	81	-	1
	4 062 00		67	-	1	67	-	1				18	-	1	82	-	1
4 062 58	40	1				69	-	1				19	-	1	83	-	1
60	-	1	4 076 00			71	-	1				20	-	1	84	-	1
			4 076 17	32	1	72	-	1				21	-	1	85	-	1
			18	-	1	73	-	1				22	-	1	86	-	1
			19	-	1	74	-	1				23	-	1	87	-	1
			21	-	1	75	-	1				24	-	1	88	-	1
			22	-	1	76	-	1				25	-	1	89	-	1
			24	-	1	77	-	1				26	-	1	90	-	1
												27	-	1	91	-	1

Cat.Nos	Page No	Pack	Cat.Nos	Page No	Pack	Cat.Nos	Page No	Pack	Cat.Nos	Page No	Pack	Cat.Nos	Page No	Pack	Cat.Nos	Page No	Pack
4 097 92	36	1	4 100 26	37	1				4 110 51	30	1	4 115 43	28	1			
93	-	1	27	-	1	4 104 00			52	-	1	50	-	1	4 125 00		
94	-	1	28	-	1	4 104 01	38	1	53	-	1	54	-	1	4 125 03	50	1
95	-	1	33	-	1	02	-	1	54	-	1	55	-	1	05	-	1
96	-	1	34	-	1	13	-	1	91	-	1	56	-	1	09	-	1
97	-	1	35	-	1	14	-	1	92	-	1	57	-	1	10	-	1
98	-	1	36	-	1	24	-	1	94	-	1	69	-	1	14	49	1
99	-	1	37	-	1	26	-	1	95	-	1	70	-	1	15	-	1
4 098 00			38	-	1	28	-	1	96	-	1	71	-	1	16	-	1
4 098 00	36	1	39	-	1	29	-	1	97	-	1	72	-	1	17	-	1
01	-	1	40	-	1	31	-	1	98	-	1	90	-	1	18	-	1
02	-	1	41	-	1	32	-	1	4 111 00			91	-	1	19	-	1
03	-	1	4 101 00			35	-	1	4 111 49	31	1	92	-	1	21	50	4
04	-	1	4 101 34	37	1	71	-	1	50	-	1	4 117 00			23	-	10
05	-	1	35	-	1	72	-	1	51	-	1	4 117 02	28	1	24	-	1
06	-	1	36	-	1	74	-	1	57	-	1	03	-	1	27	-	1
07	-	1	37	-	1	75	-	1	58	-	1	04	-	1	33	-	1
08	-	1	38	-	1	77	-	1	59	-	1	05	-	1	35	-	5
09	-	1	39	-	1	80	-	1	60	-	1	12	-	1	36	-	1
10	-	1	40	-	1	83	-	1	61	-	1	13	-	1	41	-	1
11	-	1	41	-	1	86	-	1	62	-	1	14	-	1	44	49	4
12	-	1	47	-	1	89	-	1	63	-	1	15	-	1	45	-	1
13	-	1	48	-	1	4 105 00			64	-	1	22	-	1	47	-	1
14	-	1	49	-	1	4 105 00	38	1	63	-	1	23	-	1	48	-	1
15	-	1	50	-	1	11	-	1	64	-	1	24	-	1	49	-	1
16	-	1	51	-	1	12	-	1	65	-	1	25	-	1	50	-	1
17	-	1	52	-	1	21	-	1	66	-	1	32	-	1	51	-	2
18	-	1	53	-	1	23	-	1	67	-	1	33	-	1	53	-	1
19	-	1	54	-	1	25	-	1	73	-	1	34	-	1	56	-	1
20	-	1	60	-	1	26	-	1	74	-	1	35	-	1	57	-	1
21	-	1	61	-	1	28	-	1	75	-	1	45	-	1	58	-	1
22	-	1	62	-	1	29	-	1	76	-	1	46	-	1	59	-	1
23	-	1	63	-	1	31	-	1	77	-	1	59	-	1	60	-	1
24	-	1	64	-	1	34	-	1	78	-	1	60	-	1	61	-	1
30	-	1	65	-	1	55	-	1	85	-	1	61	-	1	62	-	1
31	-	1	66	-	1	68	39	1	86	-	1	62	-	1	63	-	1
32	-	1	67	-	1	71	-	1	87	-	1	63	-	1	4 126 00		
33	-	1	73	-	1	76	-	1	88	-	1	69	-	1	4 126 02	56	10
34	-	1	74	-	1	78	-	1	90	-	1	70	-	1	23	57	1
35	-	1	75	-	1	82	-	1	91	-	1	71	-	1	30	54	1
36	-	1	76	-	1	83	-	1	92	-	1	72	-	1	31	-	1
37	-	1	77	-	1	4 106 00			4 112 00			73	-	1	32	-	1
38	-	1	78	-	1	4 106 05	39	1	4 112 04	31	1	79	-	1	33	-	1
39	-	1	79	-	1	08	-	1	05	-	1	80	-	1	41	-	1
40	-	1	80	-	1	11	-	1	06	-	1	81	-	1	44	-	1
41	-	1	86	-	1	25	-	1	07	-	1	82	-	1	45	-	1
42	-	1	87	-	1	29	-	1	08	-	1	83	-	1	54	-	1
43	-	1	88	-	1	36	-	1	09	-	1	89	29	1	57	-	1
44	-	1	89	-	1	38	-	1	10	-	1	90	-	1	4 127 00		
45	-	1	90	-	1	40	-	1	11	-	1	91	-	1	4 127 80	55	1
46	-	1	91	-	1	42	-	1	33	-	1	92	-	1	90	-	1
47	-	1	92	-	1	43	-	1	34	-	1	93	-	1	94	-	1
48	-	1	93	-	1	4 109 00			35	-	1	4 118 00			95	55	1
49	-	1	99	-	1	4 109 93	30	1	36	-	1	4 118 00	29	1	4 128 00		
50	-	1	4 102 00			97	-	1	37	-	1	4 118 01	-	1	4 128 12	55	1
51	-	1	4 102 00	37	1	99	-	1	38	-	1	4 124 00			13	-	1
52	-	1	01	-	1	4 110 00			39	-	1	4 124 00	52	1	58	57	1
53	-	1	02	-	1	4 110 00	30	1	40	-	1	01	-	1	72	54	1
54	-	1	03	-	1	02	-	1	41	-	1	4 115 00			73	-	1
55	-	1	04	-	1	12	-	1	42	-	1	4 115 00	28	1	6 064 00		
4 100 00			13	-	1	13	-	1	4 115 00			04	-	1	6 064 10	30	1
4 100 07	37	1	14	-	1	14	-	1	04	-	1	05	-	1	11	-	1
08	-	1	15	-	1	15	-	1	05	-	1	08	-	10	12	-	1
09	-	1	16	-	1	16	-	1	06	-	1	10	-	1	13	-	1
10	-	1	17	-	1	17	-	1	07	-	1	11	-	1	14	-	1
11	-	1	18	-	1	18	-	1	08	-	1	12	-	1	14	-	1
12	-	1	19	-	1	19	-	1	14	-	1	14	-	1	15	-	1
13	-	1	25	-	1	22	-	1	15	-	1	16	-	1			
14	-	1	26	-	1	24	-	1	16	-	1	29	50	1			
15	-	1	27	-	1	25	-	1	17	-	1	29	52	1			
20	-	1	28	-	1	26	-	1	24	-	1	30	50	1			
21	-	1	29	-	1	27	-	1	25	-	1	31	-	1			
22	-	1	30	-	1	28	-	1	26	-	1	33	52	1			
23	-	1	31	-	1	41	-	1	27	-	1	34	-	1			
24	-	1	32	-	1	47	-	1	28	-	1	36	-	1			
25	-	1				48	-	1	37	-	1	37	-	1			
						50	-	1	37	-	1	39	-	1			



FOLLOW US
ALSO ON

@ www.legrand.com

 www.youtube.com/legrand

 [twitter.com/@legrand](https://twitter.com/legrand)



World Headquarters
and International Department
87045 Limoges Cedex - France
Tel. : + 33 (0) 5 55 06 87 87
Fax: + 33 (0) 5 55 06 74 55