

Micro Chip Fuse

Type: **ERBRD**
ERBRE
ERBRG



■ Features

- Small size
- Fast-acting and withstanding in-rush current characteristics
- RoHS compliant

■ Approved Safety Standards

UL248-14 : File No.E194052
c-UL C22.2 No.248-14 : File No.E194052

■ Explanation of Part Numbers

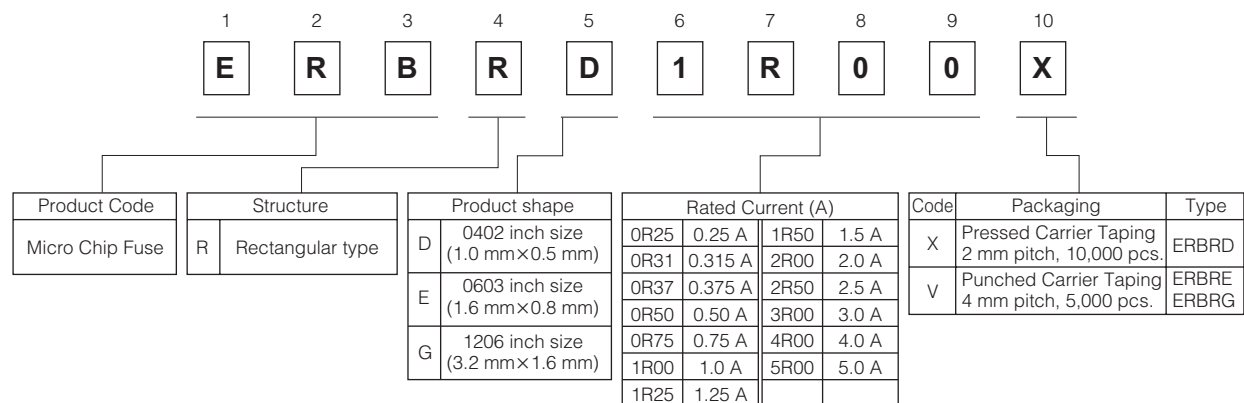

■ Construction

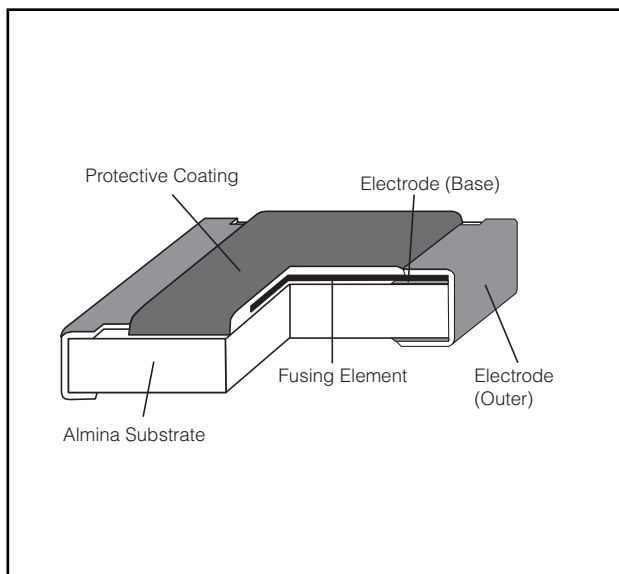

■ Dimensions in mm (not to scale)

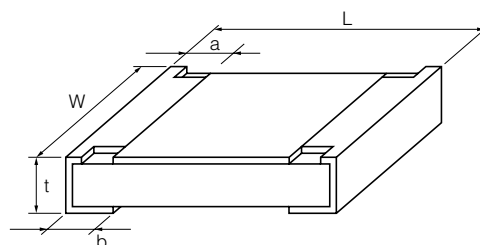

Type (inch size)	Dimensions (mm)					Mass (Weight) (g/1000 pcs.)
	L	W	a	b	t	
ERBRD (0402)	1.00 ^{±0.10}	0.50 ^{+0.10/-0.05}	0.15 ^{±0.10}	0.25 ^{±0.10}	0.39 ^{±0.10}	0.7
ERBRE (0603)	1.60 ^{±0.15}	0.80 ^{+0.15/-0.05}	0.24 ^{±0.15}	0.30 ^{±0.15}	0.54 ^{±0.10}	2.2
ERBRG (1206)	3.20 ^{±0.20}	1.60 ^{±0.15}	0.30 ^{±0.20}	0.55 ^{±0.20}	0.65 ^{±0.10}	10

■ Ratings

● 0402 inch size : Type ERBRD

Part No.	ERBRD□R□□X										
	0R25	0R31	0R37	0R50	0R75	1R00	1R25	1R50	2R00	2R50	3R00
Rated Current (A)	0.25	0.315	0.375	0.5	0.75	1.0	1.25	1.5	2.0	2.5	3.0
Marking Code	V	X	Y	F	G	H	J	K	N	O	P
Internal R (mΩ) at 25 °C max.	700	520	440	310	190	125	82	70	53	42	37
Fusing Current/Fusing Time (at 25 °C)	Rated Current ×100 %/4 hours min.										
	Rated Current ×200 %/5 seconds max.										
	Rated Current ×300 %/0.2 seconds max.										
Rated Voltage (Open Circuit Voltage)	32 VDC										
Interrupting Rating (at Rated Voltage)	35 A										
Category Temp. Range	-40 °C to +125 °C										

● 0603 inch size : Type ERBRE

Part No.	ERBRE□R□□V									
	0R50	0R75	1R00	1R25	1R50	2R00	2R50	3R00	4R00	5R00
Rated Current (A)	0.5	0.75	1.0	1.25	1.5	2.0	2.5	3.0	4.0	5.0
Marking Code	F	G	H	J	K	N	O	P	S	T
Internal R (mΩ) at 25 °C max.	330	190	125	94	72	51	40	33	22	19
Fusing Current/Fusing Time (at 25 °C)	Rated Current ×100 %/4 hours min.									
	Rated Current ×200 %/5 seconds max.									
	Rated Current ×300 %/0.2 seconds max.									
Rated Voltage (Open Circuit Voltage)	32 VDC									
Interrupting Rating (at Rated Voltage)	50 A									
Category Temp. Range	-40 °C to +125 °C									

● 1206 inch size : Type ERBRG

Part No.	ERBRG□R□□V								
	0R50	0R75	1R00	1R25	1R50	2R00	2R50	3R00	4R00
Rated Current (A)	0.5	0.75	1.0	1.25	1.5	2.0	2.5	3.0	4.0
Marking Code	F	G	H	J	K	N	O	P	S
Internal R (mΩ) at 25 °C max.	560	340	210	175	115	85	65	45	35
Fusing Current/Fusing Time (at 25 °C)	Rated Current ×100 %/4 hours min.								
	Rated Current ×200 %/5 seconds max.								
	Rated Current ×300 %/0.2 seconds max.								
Rated Voltage (Open Circuit Voltage)	63 VDC						32 VDC		
Interrupting Rating (at Rated Voltage)	50 A								
Category Temp. Range	-40 °C to +125 °C								

* The thin type is available about 1005 (0402 inch) size. Please contact us for details.

* Please contact us when another rated current is needed.

Design and specifications are each subject to change without notice. Ask factory for the current technical specifications before purchase and/or use. Should a safety concern arise regarding this product, please be sure to contact us immediately.

■ Fusing Characteristics (25 °C typical)

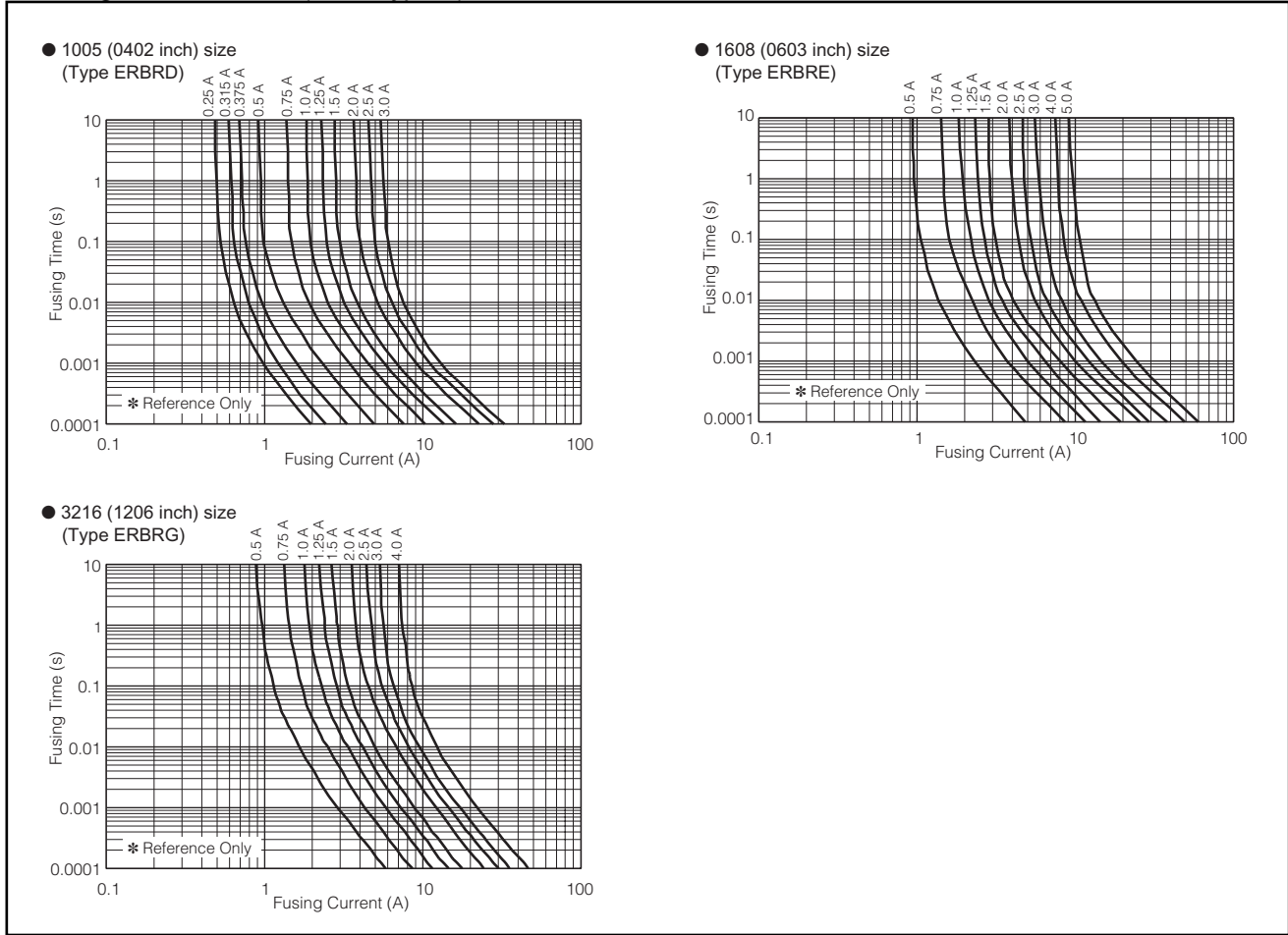

■ Packaging Methods

● Standard Quantity

Type	Kind of Taping	Pitch (P ₁)	Quantity
ERBRD	Pressed Carrier Taping	2 mm	10000 pcs./ reel
ERBRE	Punched Carrier Taping	4 mm	5000 pcs./ reel
ERBRG			

● Carrier Taping

(Unit : mm)

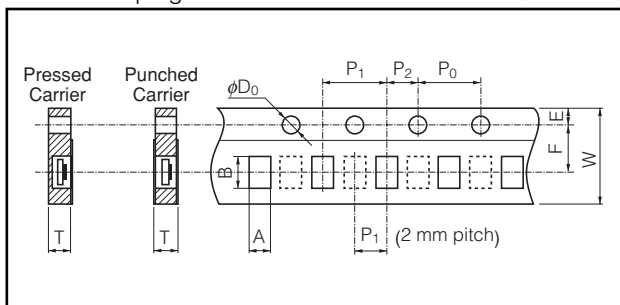

Type	A	B	W	F	E
ERBRD	0.68 ^{+0.10}	1.20 ^{+0.10}	8.00 ^{±0.20}	3.50 ^{±0.05}	1.75 ^{±0.10}
ERBRE	1.05 ^{+0.10}	1.85 ^{+0.10}			
ERBRG	2.00 ^{±0.15}	3.60 ^{±0.20}			

Type	P ₁	P ₂	P ₀	φD ₀	T
ERBRD	2.00 ^{+0.10}	2.00 ^{±0.05}	4.00 ^{±0.10}	1.50 ^{+0.10} _{-0.10}	0.67 ^{±0.07}
ERBRE	4.00 ^{±0.10}				0.78 ^{±0.07}
ERBRG					0.84 ^{±0.07}

● Taping Reel

(Unit : mm)

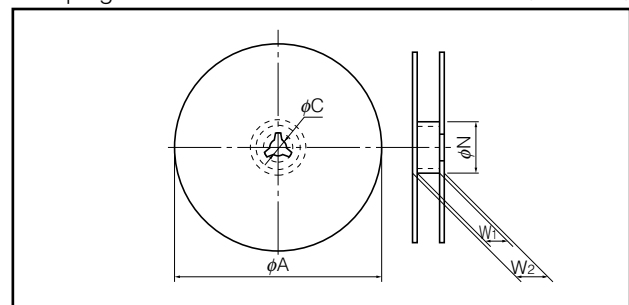

Type	φA	φN	φC	W ₁	W ₂
ERBRD	180.0 ⁺⁰ _{-1.5}	60 ^{+1.0} ₋₀	13.0 ^{±0.2}	9.0 ^{+1.0} ₋₀	11.4 ^{±1.0}
ERBRE					
ERBRG					

Design and specifications are each subject to change without notice. Ask factory for the current technical specifications before purchase and/or use. Should a safety concern arise regarding this product, please be sure to contact us immediately.

■ Recommended Land Pattern

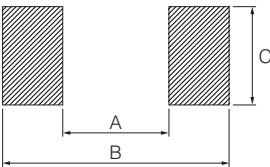

Type (inch size)	Dimensions (mm)		
	A	B	C
ERBRD(0402)	0.5 to 0.6	1.4 to 1.6	0.4 to 0.6
ERBRE(0603)	0.7 to 0.9	2.0 to 2.2	0.8 to 1.0
ERBRG(1206)	2.0 to 2.4	4.4 to 5.0	1.2 to 1.8

■ Recommended Soldering Conditions

Recommendations and precautions are described below.

- Recommended soldering conditions for reflow
 - Reflow soldering shall be performed a maximum of two times.
 - Please contact us for additional information when used in conditions other than those specified.
 - Please measure the temperature of the terminals and study every kind of solder and printed circuit board for solderability before actual use.

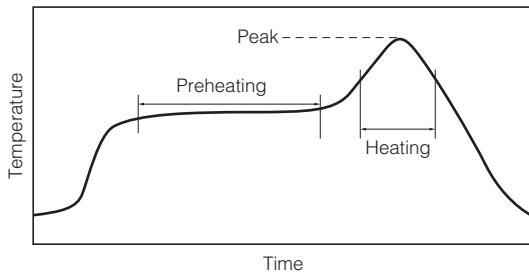

For soldering (Example : Sn/Pb)

	Temperature	Time
Preheating	140 °C to 160 °C	60 s to 120 s
Main heating	Above 200 °C	30 s to 40 s
Peak	235 ± 5 °C	max. 10 s

For lead-free soldering (Example : Sn/Ag/Cu)

	Temperature	Time
Preheating	150 °C to 180 °C	60 s to 120 s
Main heating	Above 230 °C	30 s to 40 s
Peak	max. 260 °C	max. 10 s

● Recommended soldering conditions for flow

	For soldering		For lead-free soldering	
	Temperature	Time	Temperature	Time
Preheating	140 °C to 180 °C	60 s to 120 s	150 °C to 180 °C	60 s to 120 s
Soldering	245 ± 5 °C	20 s to 30 s	max. 260 °C	max. 10 s

<Repair with hand soldering>

- Preheat with a blast of hot air or similar method. Use a soldering iron with a tip temperature of 350 °C or less. Solder each electrode for 3 seconds or less.
- Never touch this product with the tip of a soldering iron.

⚠ Safety Precautions

The following are precautions for individual products. Please also refer to the common precautions shown on page 4 of this catalog.

1. Set the rated current so that the current passing through the Micro Chip Fuses (hereafter called the fuses) under normal conditions is within 70% of the rated current.
2. Do not continuously pass a current exceeding the rated current through the fuses.
3. If a pulse exceeding the rated current is applied, such as a rush current or surge current at power-on, take care not to cause unwanted fusing. Calculate the I^2t value of the pulse and check the tolerance to the number of pulses according to the I^2t -t characteristic curve before deciding to use the fuses. Before checking the tolerance, consult our sales staff in advance.
4. The fuses are designed to be blown out by a current that is double or greater than the rated current. Ensure that the abnormal current generated when a circuit abnormality occurs in your product is at least double or greater than the rated current of the fuses. In addition, ensure that the abnormal current of your product does not exceed the maximum interrupting current of the fuses.
5. The fuses are designed to be used on the secondary side of a power supply. Do not use them on the primary side.
6. Ensure that the voltage applied to the fuses are within their rated voltage.
7. The fusing characteristics of the fuses are affected by the ambient temperature. Before use, mount the fuses on your products and carefully check and evaluate their category temperature range.

Design and specifications are each subject to change without notice. Ask factory for the current technical specifications before purchase and/or use. Should a safety concern arise regarding this product, please be sure to contact us immediately.