

*RoHS COMPLIANT

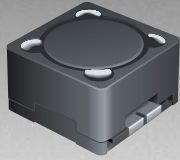

BOURNS®

Features

- Available in E6 series
- Unit height of 8.5 mm
- Current up to 7.5 A
- RoHS compliant*

Applications

- Input/output of DC/DC converters
- Power supplies for:
 - Portable communication equipment
 - Camcorders
 - LCD TVs
 - Car radios

SRR1208 Series - Shielded High Power Inductors

Electrical Specifications

Bourns Part No.	Inductance 1kHz		Q Ref.	Test Frequency (MHz)	SRF Min. (MHz)	RDC Max. (Ω)	I rms Max. (A)	I sat Typ. (A)
	(μH)	Tol. %						
SRR1208-2R5ML	2.5	± 20	20	7.96	37	0.011	7.50	10.00
SRR1208-4R5ML	4.5	± 20	24	7.96	30	0.014	6.50	10.00
SRR1208-6R5ML	6.5	± 20	25	7.96	20	0.018	6.00	8.40
SRR1208-100ML	10	± 20	20	2.52	15	0.021	5.00	6.70
SRR1208-120ML	12	± 20	19	2.52	11	0.025	4.80	6.50
SRR1208-150ML	15	± 20	21	2.52	11	0.036	4.00	5.60
SRR1208-180ML	18	± 20	21	2.52	9.0	0.040	3.80	4.00
SRR1208-220ML	22	± 20	23	2.52	7.0	0.043	3.50	4.00
SRR1208-270ML	27	± 20	23	2.52	6.5	0.048	3.00	4.30
SRR1208-330YL	33	± 15	23	2.52	6.5	0.062	2.80	3.80
SRR1208-390YL	39	± 15	25	2.52	6.0	0.076	2.50	3.40
SRR1208-470YL	47	± 15	24	2.52	5.0	0.085	2.20	3.10
SRR1208-560YL	56	± 15	23	2.52	5.0	0.110	2.00	2.80
SRR1208-680YL	68	± 15	20	2.52	5.0	0.135	1.80	2.60
SRR1208-820YL	82	± 15	18	2.52	4.0	0.150	1.60	2.30
SRR1208-101YL	100	± 15	15	0.796	4.0	0.170	1.50	2.10
SRR1208-121YL	120	± 15	15	0.796	3.0	0.190	1.40	2.00
SRR1208-151YL	150	± 15	14	0.796	3.0	0.240	1.30	1.72
SRR1208-181YL	180	± 15	14	0.796	2.5	0.270	1.20	1.70
SRR1208-221KL	220	± 10	13	0.796	2.5	0.380	1.10	1.45
SRR1208-271KL	270	± 10	13	0.796	2.0	0.400	0.95	1.25
SRR1208-331KL	330	± 10	13	0.796	1.8	0.650	0.85	1.12
SRR1208-391KL	390	± 10	14	0.796	1.6	0.670	0.80	1.10
SRR1208-471KL	470	± 10	14	0.796	1.4	0.850	0.70	0.95
SRR1208-561KL	560	± 10	14	0.796	1.4	0.900	0.65	0.90
SRR1208-681KL	680	± 10	13	0.796	1.2	1.00	0.60	0.82
SRR1208-821KL	820	± 10	12	0.796	1.2	1.15	0.55	0.77
SRR1208-102KL	1000	± 10	11	0.252	1.0	1.65	0.50	0.67
SRR1208-122KL	1200	± 10	10	0.252	0.80	2.00	0.40	0.57
SRR1208-152KL	1500	± 10	10	0.252	0.75	2.35	0.36	0.55
SRR1208-182KL	1800	± 10	20	0.252	0.70	3.40	0.46	0.48
SRR1208-222KL	2200	± 10	20	0.252	0.65	4.20	0.40	0.42
SRR1208-272KL	2700	± 10	20	0.252	0.60	5.20	0.35	0.38
SRR1208-332KL	3300	± 10	20	0.252	0.50	6.40	0.32	0.35
SRR1208-392KL	3900	± 10	20	0.252	0.45	7.80	0.30	0.32
SRR1208-472KL	4700	± 10	20	0.252	0.42	9.60	0.28	0.30
SRR1208-562KL	5600	± 10	18	0.252	0.40	12.0	0.25	0.28
SRR1208-682KL	6800	± 10	18	0.252	0.38	15.2	0.22	0.25
SRR1208-822KL	8200	± 10	16	0.252	0.35	17.0	0.20	0.22
SRR1208-103KL	10000	± 10	24	0.0796	0.30	19.2	0.18	0.20

Electrical Schematic

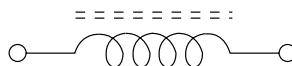

General Specifications

Test Voltage 1 V
 Reflow Soldering ...230 °C, 50 sec. max.
 Operating Temperature ...-40 °C to +125 °C
 (Temperature rise included)
 Storage Temperature...-40 °C to +125 °C
 Resistance to Soldering Heat
260 °C for 5 sec.

Materials

Core.....Ferrite DR and RI core
 Wire.....Enameled copper
 BaseLCP E4008
 TerminalCu/Ni/Sn
 Rated Current
Ind. drop 10 % typ. at Isat
 Temperature Rise
40 °C max. at rated Irms
 Packaging.....400 pcs. per reel

Product Dimensions

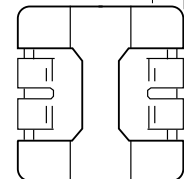
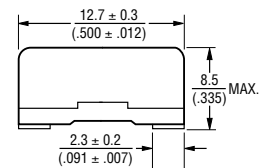
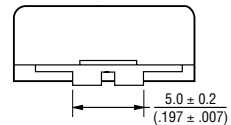
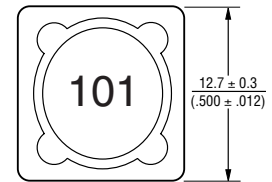

DIMENSIONS:
MM
(INCHES)

Recommended Layout

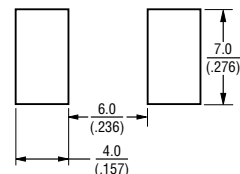

*RoHS Directive 2002/95/EC Jan 27, 2003 including Annex.
 Specifications are subject to change without notice.
 Customers should verify actual device performance in their specific applications.

SRR1208 Series - Shielded High Power Inductors

BOURNS®

Packaging Specifications

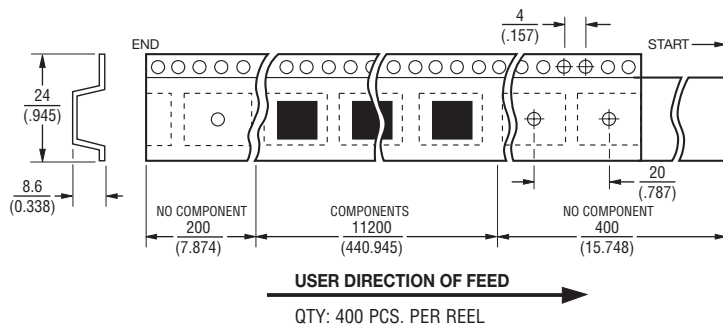
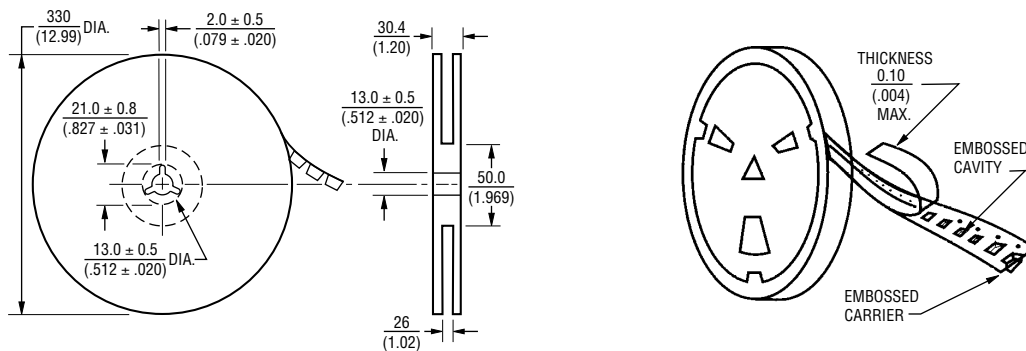

DIMENSIONS: $\frac{\text{MM}}{\text{(INCHES)}}$

REV. 09/11

Specifications are subject to change without notice.
Customers should verify actual device performance in their specific applications.