

Automotive 5 V low dropout voltage regulator

Datasheet - production data

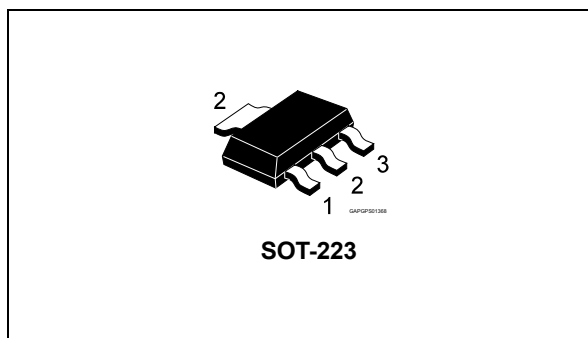

- Low quiescent current
- Precision output voltage 5 V $\pm 2\%$
- Very wide stability range with low value output capacitor
- Thermal shutdown and short-circuit protection
- Wide temperature range ($T_j = -40\text{ }^\circ\text{C}$ to $150\text{ }^\circ\text{C}$)

Description

L5150BN is a low dropout linear 5 V regulator particularly suitable for automotive applications.

High output voltage accuracy ($\pm 2\%$) is kept over wide temperature range line and load variation.

Its sophisticated design allows to have extremely low quiescent current.

The maximum input voltage is 40 V.

The regulator output current is internally limited and the device is protected against short-circuit, overload and overtemperature conditions. In addition, only low-value ceramic capacitor on output is required for stability.

Features

Max DC supply voltage	V_S	40V
Max output voltage tolerance	ΔV_O	$\pm 2\%$
Max dropout voltage	V_{dp}	500 mV
Output current	I_o	150 mA
Quiescent current	I_q	$50\text{ }\mu\text{A}^{(1)}$

1. Typical value.



- AEC-Q100 qualified
- Operating DC supply voltage range 5.6 V to 40 V
- Low dropout voltage

Table 1. Device summary

Package	Order codes	
	Tube	Tape & reel
SOT-223	L5150BN	L5150BNTR

Contents

1	Block diagram and pins description	5
2	Electrical specifications	6
2.1	Absolute maximum ratings	6
2.2	Thermal data	6
2.3	Electrical characteristics	7
2.4	Electrical characteristics curves	8
2.5	Application information	10
3	Package and PCB thermal data	12
3.1	SOT-223 thermal data	12
4	Package and packing information	15
4.1	SOT-223 package information	15
4.2	SOT-223 packing information	17
5	Revision history	18

List of tables

Table 1.	Device summary	1
Table 2.	Pins description	5
Table 3.	Absolute maximum ratings	6
Table 4.	Thermal data	6
Table 5.	General	7
Table 6.	SOT-223 thermal parameter	14
Table 7.	SOT-223 package mechanical data	16
Table 8.	Document revision history	18

List of figures

Figure 1.	Block diagram	5
Figure 2.	Output voltage vs. T_j	8
Figure 3.	Output voltage vs. V_S	8
Figure 4.	Drop voltage vs. output current	8
Figure 5.	Current consumption vs. output current	8
Figure 6.	Current consumption vs. output current (at light load condition)	8
Figure 7.	Current consumption vs. input voltage ($I_o = 0.1$ mA)	8
Figure 8.	Current consumption vs. input voltage ($I_o = 75$ mA)	9
Figure 9.	Current limitation vs. T_j	9
Figure 10.	Current limitation vs. input voltage	9
Figure 11.	Short-circuit current vs. T_j	9
Figure 12.	Short-circuit current vs. input voltage	9
Figure 13.	PSRR	9
Figure 14.	Application schematic	10
Figure 15.	Stability region	11
Figure 16.	Maximum load variation response	11
Figure 17.	SOT-223 PC board	12
Figure 18.	$R_{thj-amb}$ vs. PCB copper area in open box free air condition	12
Figure 19.	SOT-223 thermal impedance junction ambient single pulse	13
Figure 20.	Thermal fitting model of V_{reg} in SOT-223	13
Figure 21.	SOT-223 package outline	15
Figure 22.	SOT-223 tape and reel shipment (suffix "TR")	17

1 Block diagram and pins description

Figure 1. Block diagram

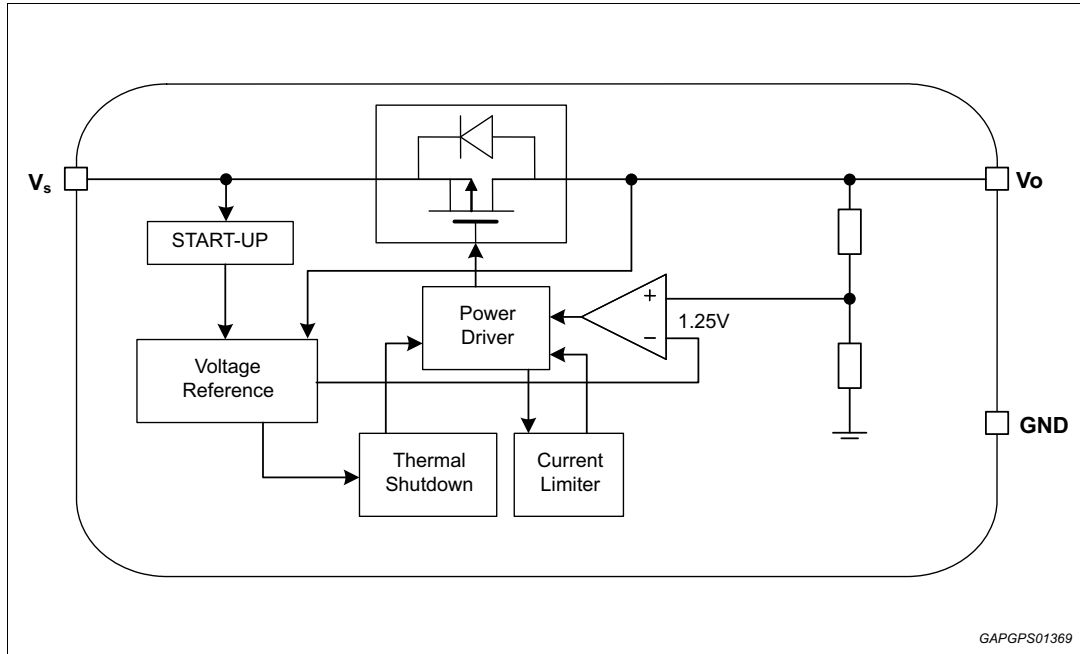

GAPGPS01369

Table 2. Pins description

N°	Pin name ⁽¹⁾	Function
1	V _S	Supply voltage, block directly to GND on the IC with a capacitor.
2	GND	Ground reference
3	V _O	5 V regulated output. Block to GND with a ceramic capacitor (C ₀ ≥ 220 nF for regulator stability)

1. For the pins configuration see outlines at page 1.

2 Electrical specifications

2.1 Absolute maximum ratings

Stressing the device above the rating listed in the [Table 3: Absolute maximum ratings](#) may cause permanent damage to the device. These are stress ratings only and operation of the device at these or any other conditions above those indicated in the operating sections of this specification is not implied. Exposure to absolute maximum rating conditions for extended periods may affect device reliability. Refer also to the STMicroelectronics SURE program and other relevant quality documents.

Table 3. Absolute maximum ratings

Symbol	Parameter	Value	Unit
V_{sdc}	DC supply voltage	-0.3 to 40	V
I_{sdc}	Input current	internally limited	
V_o	DC output voltage	-0.3 to 6	V
I_o	DC output current	internally limited	
T_j	Junction temperature	-40 to 150	°C
$V_{ESD\ HBM}$	ESD voltage level (HBM-MIL STD 883C)	±2	kV
$V_{ESD\ CDM}$	ESD voltage level (CDM AEC-Q100-011)	±750	V

2.2 Thermal data

Table 4. Thermal data

Symbol	Parameter	Value ⁽¹⁾	Unit
$R_{thj-case}$	Thermal resistance junction to case: SOT-223	20	°K/W
$R_{thj-amb}$	Thermal resistance junction to ambient: SOT-223	79	°K/W

1. The values quoted are for PCB 58 mm x 58 mm x 2 mm, FR4, double copper layer with single heatsink layer, copper thickness 35 µm, copper area 2 cm².

2.3 Electrical characteristics

Values specified in this section are for $V_S = 5.6 \text{ V}$ to 31 V , $T_j = -40 \text{ }^\circ\text{C}$ to $+150 \text{ }^\circ\text{C}$ unless otherwise stated.

Table 5. General

Pin	Symbol	Parameter	Test condition	Min.	Typ.	Max.	Unit
V_o	V_{o_ref}	Output voltage	$V_S = 8 \text{ V}$ to 18 V , $I_o = 8 \text{ mA}$ to 150 mA	4.9	5.0	5.1	V
V_o	V_{o_ref}	Output voltage	$V_S = 5.6 \text{ V}$ to 31 V , $I_o = 8 \text{ mA}$ to 150 mA	4.85	5.0	5.15	V
V_o	V_{o_ref}	Output voltage	$V_S = 5.6 \text{ V}$ to 31 V , $I_o = 0.1 \text{ mA}$ to 8 mA	4.75	5.0	5.25	V
V_o	I_{short}	Short-circuit current	$V_S = 13.5 \text{ V}$	0.65	1.10	1.45	A
V_o	I_{lim}	Output current limitation ⁽¹⁾	$V_S = 13.5 \text{ V}$	0.28	0.45	0.66	A
V_S, V_o	V_{line}	Line regulation voltage	$V_S = 6 \text{ V}$ to 28 V , $I_o = 30 \text{ mA}$	–	–	40	mV
V_o	V_{load}	Load regulation voltage	$V_S = 8 \text{ V}$ to 18 V , $I_o = 8 \text{ mA}$ to 150 mA	–	–	55	mV
			$V_S = 13.5 \text{ V}$, $T_j = 25 \text{ }^\circ\text{C}$, $I_o = 8 \text{ mA}$ to 150 mA	–	–	40	
V_S, V_o	V_{dp}	Drop voltage ⁽²⁾	$I_o = 150 \text{ mA}$	–	–	500	mV
V_S, V_o	SVR	Ripple rejection	$f_r = 100 \text{ Hz}$ ⁽³⁾	–	48	–	dB
V_o	I_{oth_H}	Normal consumption mode output current	$V_S = 8 \text{ V}$ to 18 V	8	–	–	mA
V_o	I_{oth_L}	Very low consumption mode output current	$V_S = 8 \text{ V}$ to 18 V	–	–	1.1	mA
V_o	I_{oth_Hyst}	Output current switching threshold hysteresis	$V_S = 13.5 \text{ V}$, $T_j = 25 \text{ }^\circ\text{C}$	–	0.8	–	mA
V_S, V_o	I_{qn_1}	Current consumption $I_{qn_1} = I_{V_S} - I_o$	$V_S = 13.5 \text{ V}$, $I_o = 0.1 \text{ mA}$ to 1 mA , $T_j = 25 \text{ }^\circ\text{C}$	–	50	80	μA
			$V_S = 13.5 \text{ V}$, $I_o = 0.1 \text{ mA}$ to 1 mA ,	–	–	95	
V_S, V_o	I_{qn_150}	Current consumption $I_{qn_150} = I_{V_S} - I_o$	$V_S = 13.5 \text{ V}$, $I_o = 150 \text{ mA}$	–	3.2	4.2	mA
–	T_w	Thermal protection temperature	–	150	–	190	$^\circ\text{C}$
–	T_{w_hy}	Thermal protection temperature hysteresis	–	–	10	–	$^\circ\text{C}$

1. Measured output current when the output voltage has dropped 100 mV from its nominal value obtained at 13.5 V and $I_o = 75 \text{ mA}$.
2. $V_S - V_o$ measured dropout when the output voltage has dropped 100 mV from its nominal value obtained at 13.5 V and $I_o = 75 \text{ mA}$.
3. Guaranteed by design.

2.4 Electrical characteristics curves

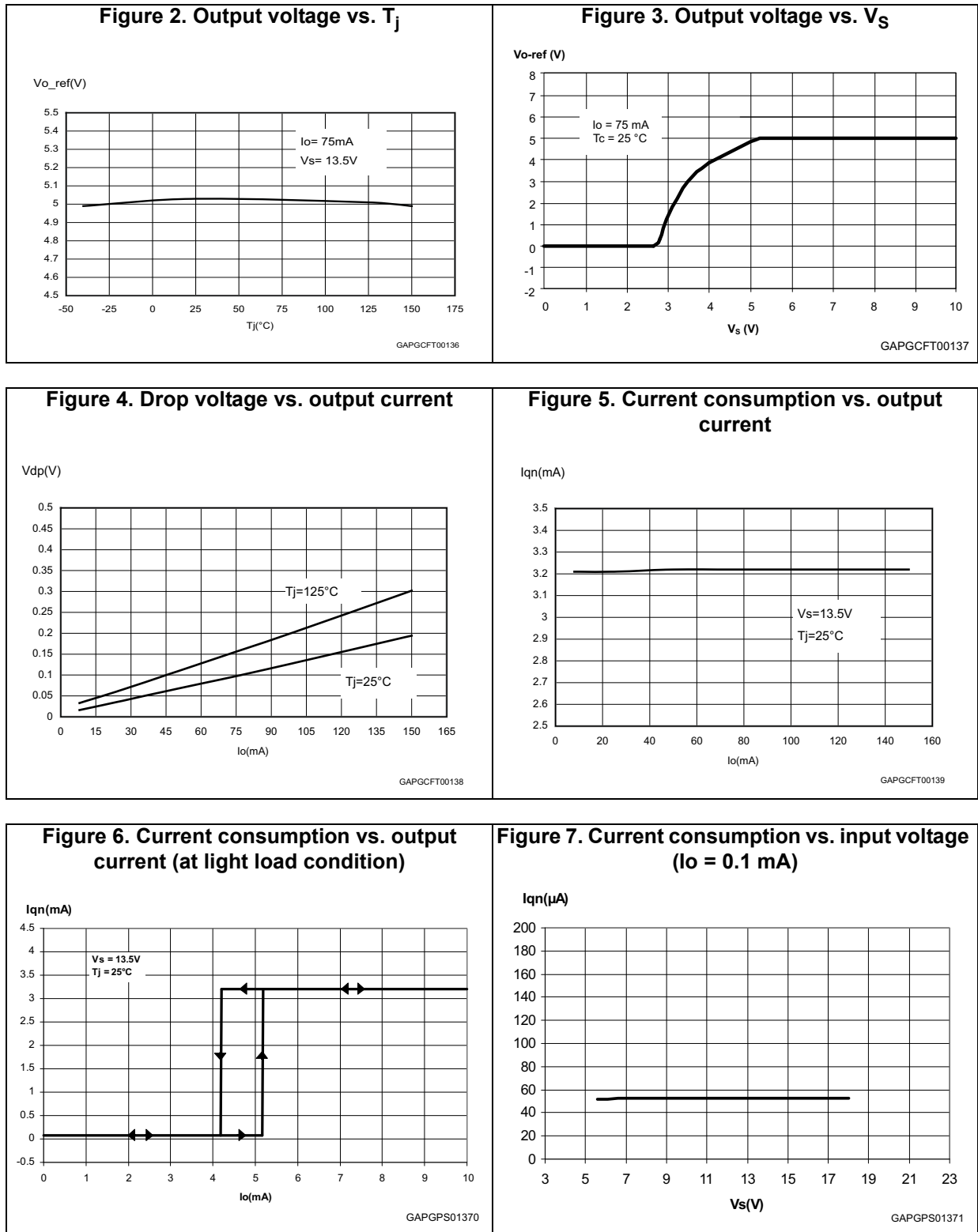

Figure 8. Current consumption vs. input voltage (Io = 75 mA)

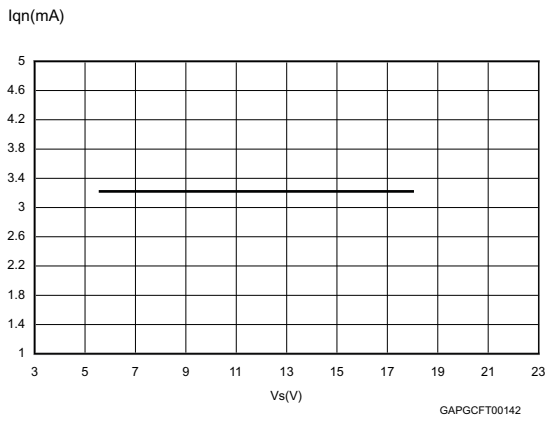

Figure 9. Current limitation vs. Tj

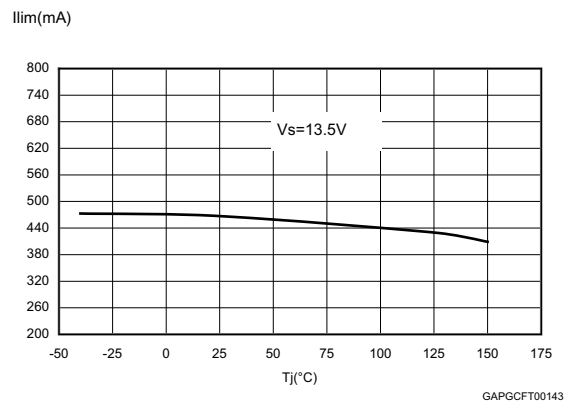

Figure 10. Current limitation vs. input voltage

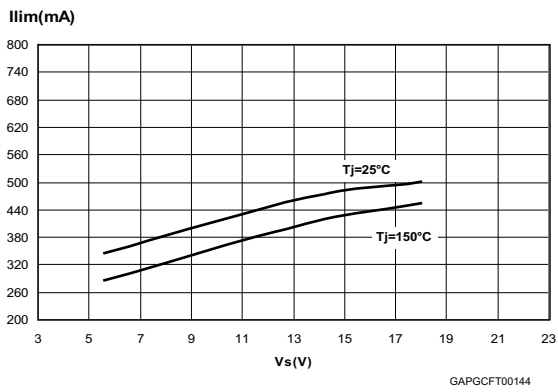

Figure 11. Short-circuit current vs. Tj

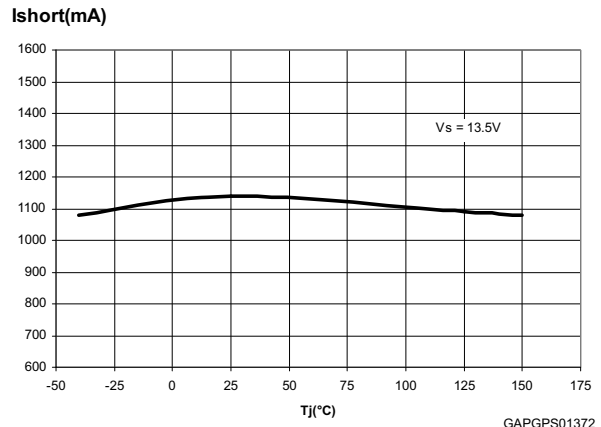

Figure 12. Short-circuit current vs. input voltage

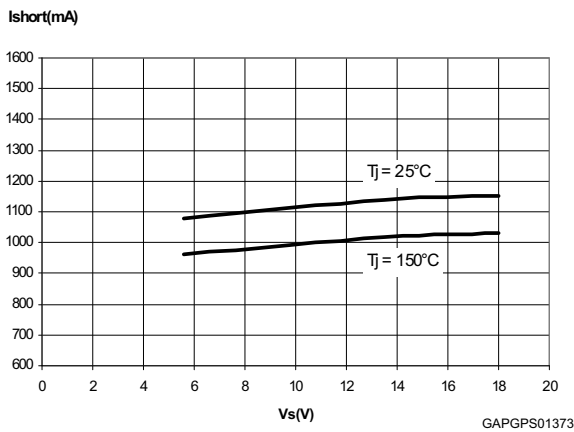
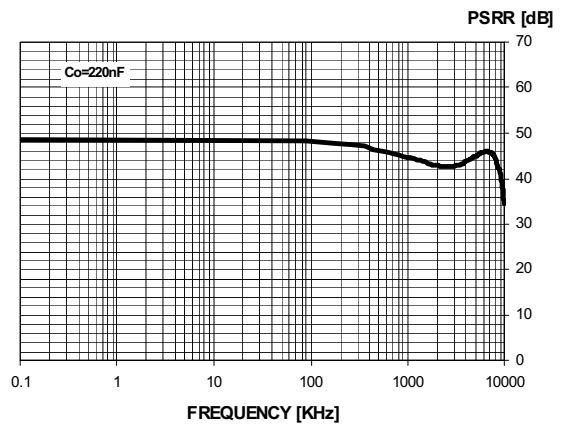

Figure 13. PSRR



2.5 Application information

The voltage regulator uses a p-channel mos transistor as a regulating element. With this structure a very low dropout voltage at current up to 150 mA is obtained. The output voltage is regulated up to input supply voltage of 40 V. The high-precision of the output voltage ($\pm 2\%$) is obtained with a pre-trimmed reference voltage. The voltage regulator automatically adapts its own quiescent current to the output current level. In light-load conditions the quiescent current goes to 55 μA only (low consumption mode). This procedure features a certain hysteresis on the output current (see [Figure 6](#)). Short-circuit protection to GND and a thermal shutdown are provided.

Figure 14. Application schematic

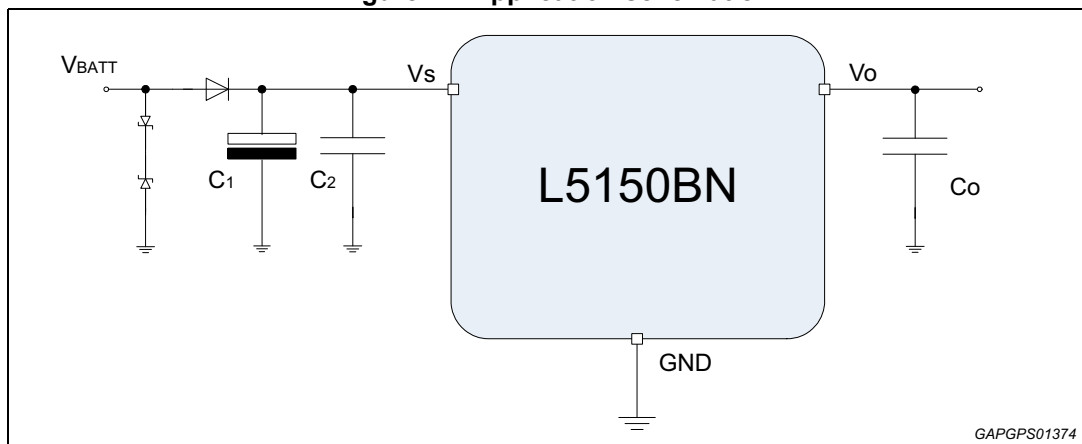

The input capacitor $C_1 \geq 100 \mu\text{F}$ is necessary as backup supply for negative pulses which may occur on the line. The second input capacitor $C_2 \geq 220 \text{ nF}$ is needed when the C_1 is too distant from the V_S pin and it compensates smooth line disturbances. The C_0 ceramic capacitor, connected to the output pin, is for bypassing to GND the high-frequency noise and it guarantees stability even during sudden line and load variations. Suggested value is $C_0 = 220 \text{ nF}$ with $\text{ESR} \geq 100 \text{ m}\Omega$.

Stability region is reported in [Figure 15](#).

Figure 15. Stability region

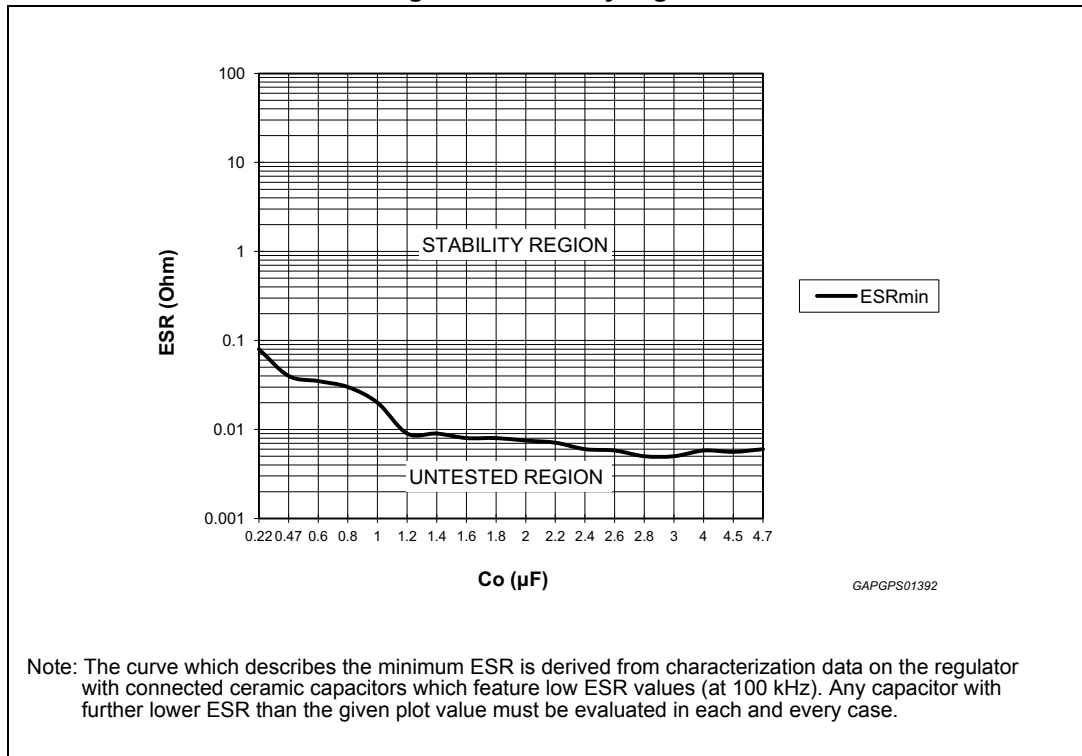
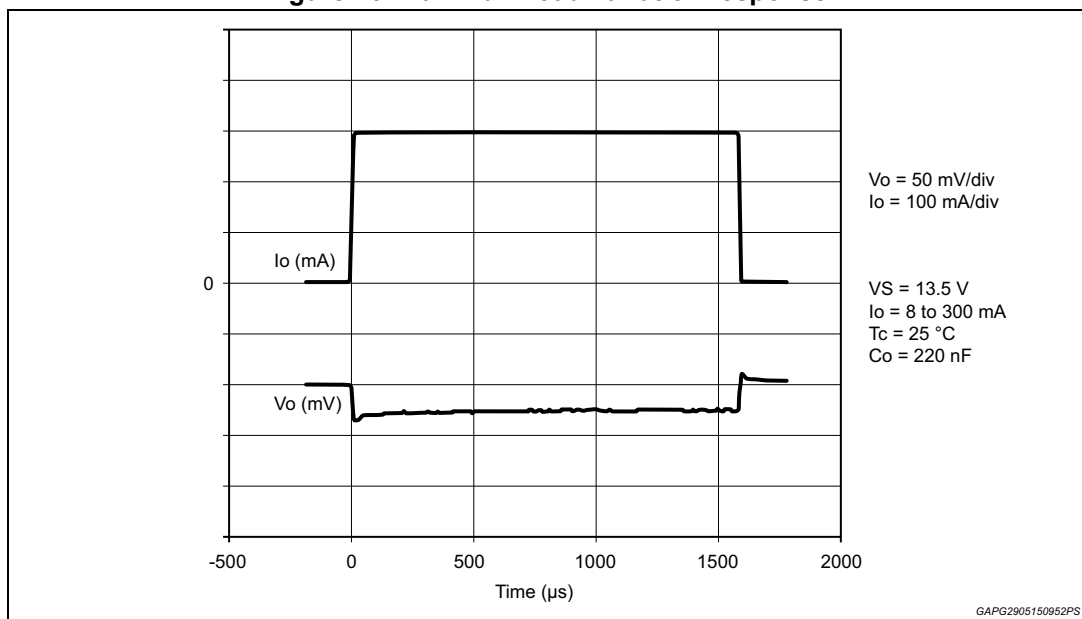

Figure 16. Maximum load variation response



3 Package and PCB thermal data

3.1 SOT-223 thermal data

Figure 17. SOT-223 PC board

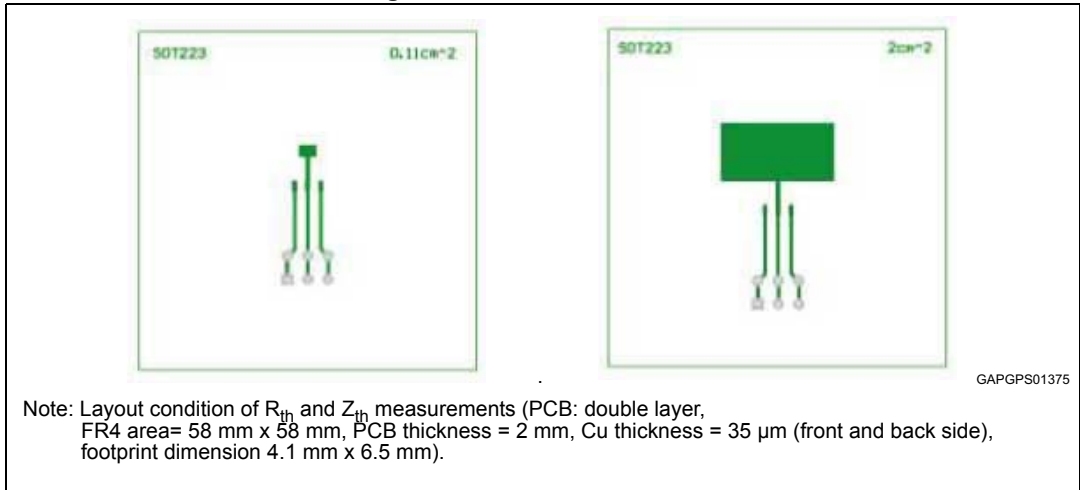

Figure 18. $R_{thj-amb}$ vs. PCB copper area in open box free air condition

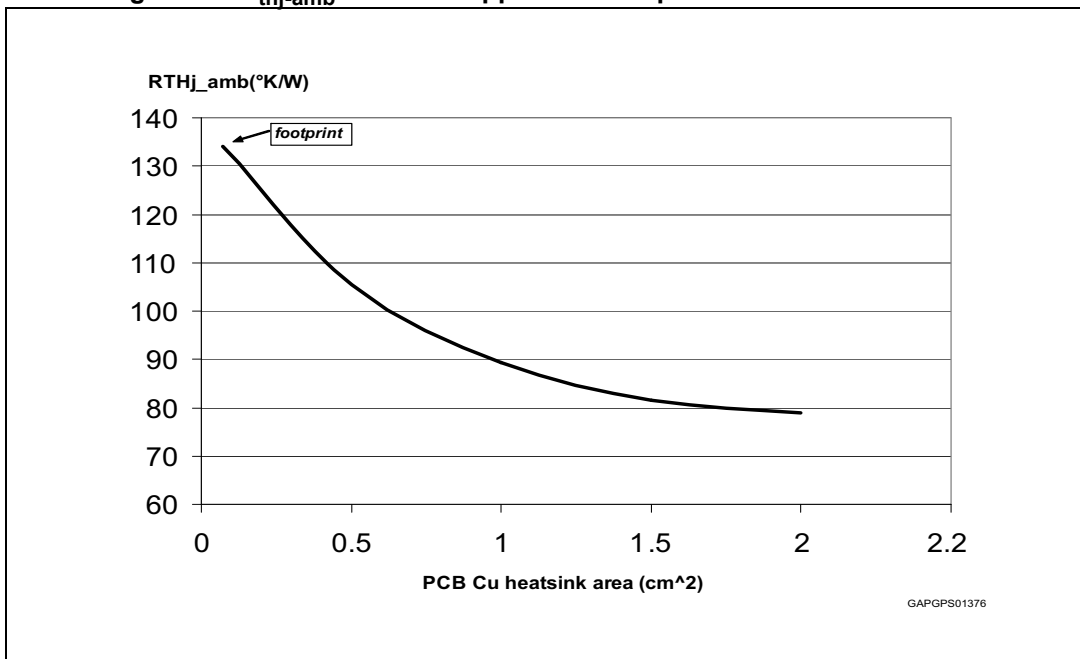
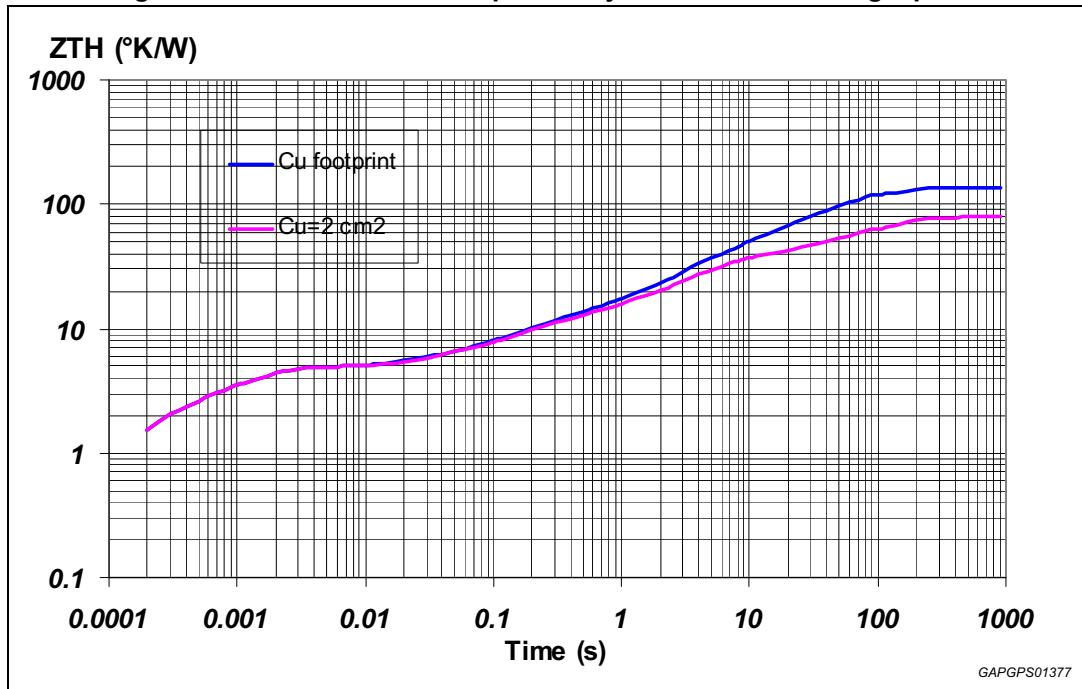

Figure 19. SOT-223 thermal impedance junction ambient single pulse



Equation 1: pulse calculation formula

$$Z_{TH\delta} = R_{TH} \cdot \delta + Z_{THtp}(1 - \delta)$$

where $\delta = t_p/T$

Figure 20. Thermal fitting model of Vreg in SOT-223

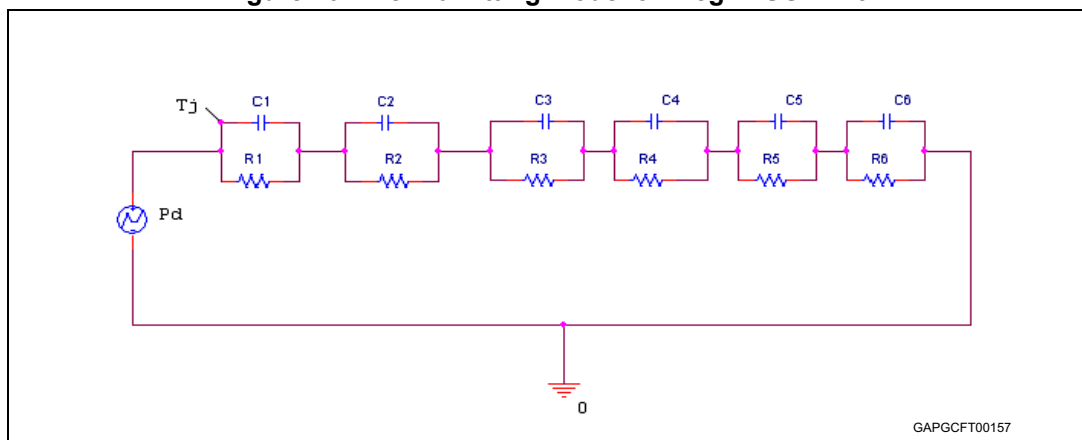

Table 6. SOT-223 thermal parameter

Area (cm ²)	Footprint	2
R1 (°K/W)	1.53	
R2 (°K/W)	3.21	
R3 (°K/W)	5.2	
R4 (°K/W)	24	
R5 (°K/W)	0.1	
R6 (°K/W)	100	45
C1 (W.s/°K)	0.00004	
C2 (W.s/°K)	0.0003	
C3 (W.s/°K)	0.03	
C4 (W.s/°K)	0.16	
C5 (W.s/°K)	1000	
C6 (W.s/°K)	0.5	2

4 Package and packing information

In order to meet environmental requirements, ST offers these devices in different grades of ECOPACK[®] packages, depending on their level of environmental compliance. ECOPACK[®] specifications, grade definitions and product status are available at: www.st.com. ECOPACK[®] is an ST trademark.

4.1 SOT-223 package information

Figure 21. SOT-223 package outline

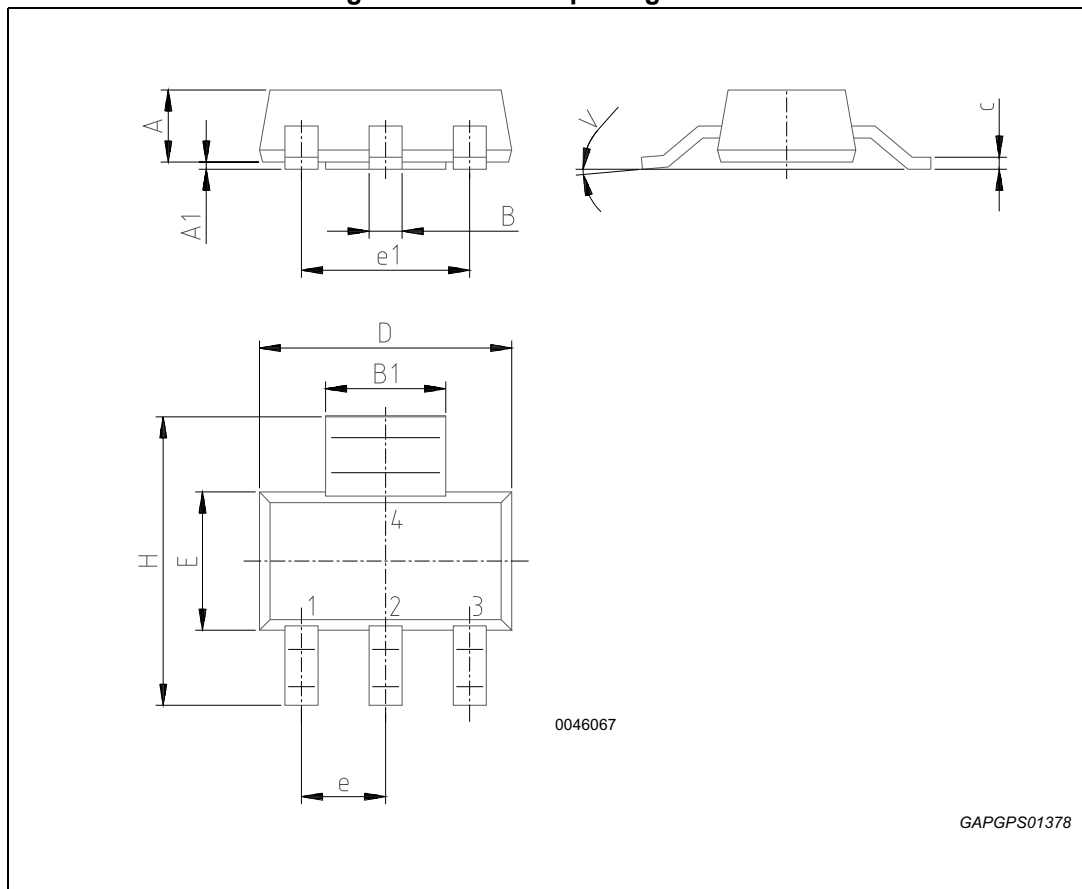
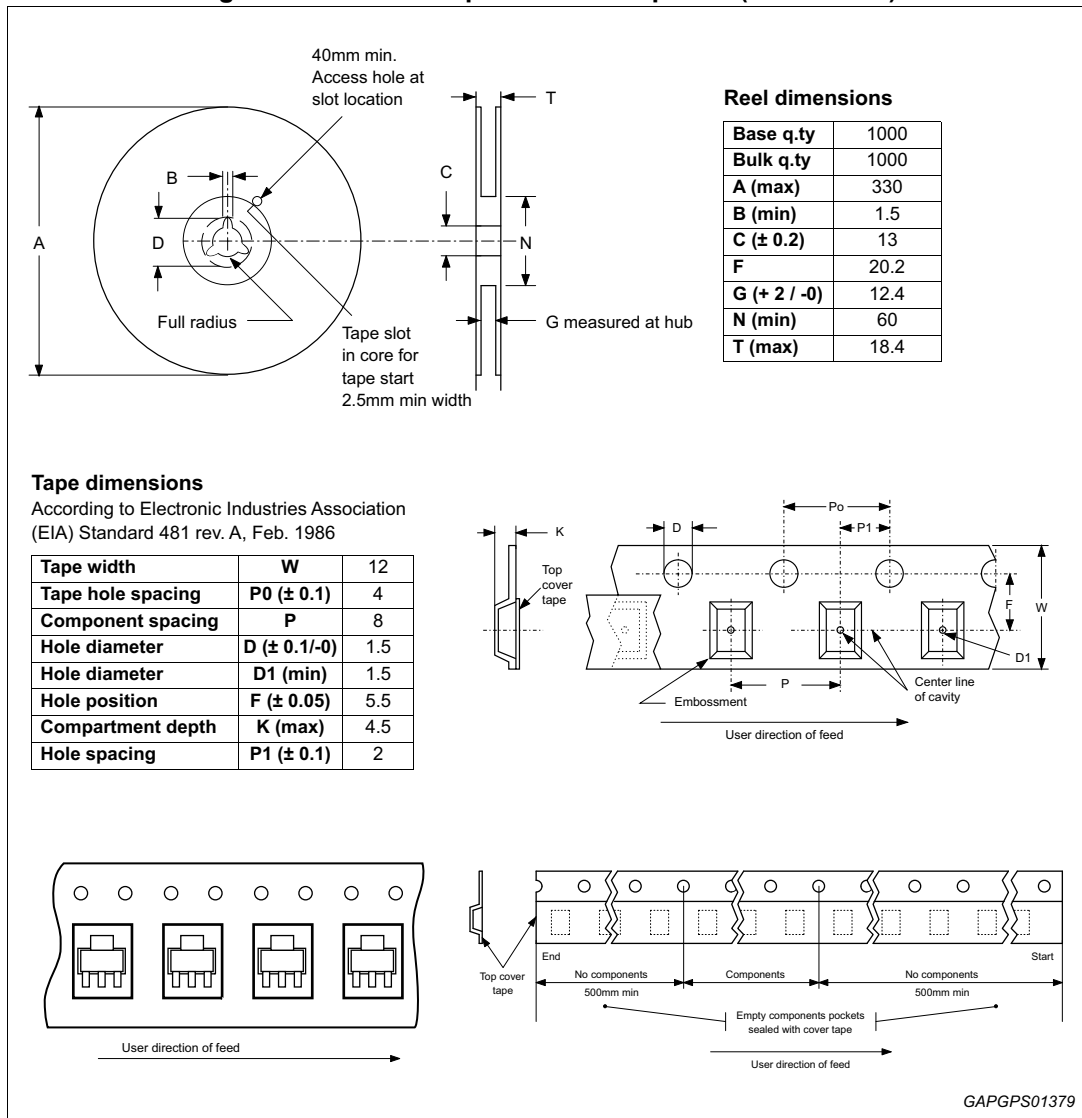

Table 7. SOT-223 package mechanical data

Ref.	Dimensions					
	Millimeters			inches		
	Min.	Typ.	Max.	Min.	Typ.	Max.
A	–	–	1.8	–	–	0.071
B	0.6	0.7	0.85	0.024	0.027	0.033
B1	2.9	3	3.15	0.114	0.118	0.124
c	0.24	0.26	0.35	0.009	0.01	0.014
D	6.3	6.5	6.7	0.248	0.256	0.264
e	–	2.3	–	–	0.09	–
e1	–	4.6	–	–	0.181	–
E	3.3	3.5	3.7	0.13	0.138	0.146
H	6.7	7	7.3	0.264	0.276	0.287
V	10 (max)					
A1	0.02	–	0.1	0.0008	–	0.004

4.2 SOT-223 packing information

Figure 22. SOT-223 tape and reel shipment (suffix "TR")



5 Revision history

Table 8. Document revision history

Date	Revision	Changes
18-Jun-2007	1	Initial release.
14-May-2008	2	Corrected Table 2: Pins description : inverted 1 and 3 pins descriptions. Updated Table 5: General : – V_{o_ref} parameter: updated test conditions and values. – V_{line} and V_{short} : updated test condition – I_{short} : changed values from 0.65/0.95/1.25 to 0.65/1.10/1.45 (Min/Typ/Max) – I_{lim} : changed values from 0.7/1/1.30 to 0.28/0.45/0.66, added note – V_{dp} : added note – Inserted $I_{o_th_L}$, $I_{o_th_H}$, $I_{o_th_Hyst}$ rows – I_{qn_1} : changed values from 38/48 to 48/70 (Typ/Max).
09-Sep-2008	3	Updated Table 5: General : – V_{load} parameter: changed test conditions.

Table 8. Document revision history (continued)

Date	Revision	Changes
16-Jun-2009	4	<p>Updated corporate template (from V2 to V3) Changed document title <i>Section : Features</i> on cover page – I_q on table: changed value from 48 μA to 50 μA – Added row in bullet list <i>Table 2: Pins description</i> V_o: changed ceramic capacitor expression for Function <i>Table 3: Absolute maximum ratings</i> – Updated all symbols <i>Table 4: Thermal data</i> – $R_{thj-amb}$: changed value – Updated TableFootnote <i>Table 5: General</i> – V_{load}: changed max value for $V_s = 8$ V to 18 V, added new row – I_{qn_1}: changed Test condition (added $T_j = 25$ °C), changed typ/max value for $T_j = 25$ °C, added new row – I_{qn_150}: changed typ value Added <i>Figure 2: Output voltage vs. Tj</i> Added <i>Figure 3: Output voltage vs. VS</i> Added <i>Figure 4: Drop voltage vs. output current</i> Added <i>Figure 5: Current consumption vs. output current</i> Added <i>Figure 6: Current consumption vs. output current (at light load condition)</i> Added <i>Figure 7: Current consumption vs. input voltage (Io = 0.1 mA)</i> Added <i>Figure 8: Current consumption vs. input voltage (Io = 75 mA)</i> Added <i>Figure 9: Current limitation vs. Tj</i> Added <i>Figure 10: Current limitation vs. input voltage</i> Added <i>Figure 11: Short-circuit current vs. Tj</i> Added <i>Figure 12: Short-circuit current vs. input voltage</i> Added <i>Figure 13: PSRR</i> <i>Section 2.5: Application information</i> – Changed section title from “Voltage regulator“ to “Application information“ – Updated text – Added <i>Figure 14: Application schematic</i> – Added <i>Figure 16: Maximum load variation response</i> Added <i>Section 3: Package and PCB thermal data</i> Changed <i>Section 4.1: ECOPACK®</i></p>
04-Dec-2009	5	<p>Updated features list. Updated <i>Section 2.5: Application information.</i></p>
06-Apr-2010	6	<p>Updated <i>Table 5: General</i>: – I_{qn_1} and I_{qn_150}: updated test parameter.</p>
30-Jan-2012	7	Modified <i>Figure 15: Stability region on page 11.</i>
07-Feb-2012	8	Modified <i>Figure 15: Stability region on page 11.</i>

Table 8. Document revision history (continued)

Date	Revision	Changes
23-Sep-2013	9	Updated disclaimer.
03-Jun-2015	10	Changed in Table 5 the typical value of SVR from 60 dB to 48 dB.
25-Sep-2018	11	Updated title and added the feature “AEC-Q100 qualified” in cover page with automotive logo.

IMPORTANT NOTICE – PLEASE READ CAREFULLY

STMicroelectronics NV and its subsidiaries ("ST") reserve the right to make changes, corrections, enhancements, modifications, and improvements to ST products and/or to this document at any time without notice. Purchasers should obtain the latest relevant information on ST products before placing orders. ST products are sold pursuant to ST's terms and conditions of sale in place at the time of order acknowledgement.

Purchasers are solely responsible for the choice, selection, and use of ST products and ST assumes no liability for application assistance or the design of Purchasers' products.

No license, express or implied, to any intellectual property right is granted by ST herein.

Resale of ST products with provisions different from the information set forth herein shall void any warranty granted by ST for such product.

ST and the ST logo are trademarks of ST. All other product or service names are the property of their respective owners.

Information in this document supersedes and replaces information previously supplied in any prior versions of this document.

© 2018 STMicroelectronics – All rights reserved

Mouser Electronics

Authorized Distributor

Click to View Pricing, Inventory, Delivery & Lifecycle Information:

[STMicroelectronics:](#)

[L5150BNTR](#)