

Pluggable interface relays CR-P Pcb relays

Pluggable interface relays are used for electrical isolation, amplification and signal matching between the electronic controlling, e.g. PLC (programmable logic controller), PC or field bus systems and the sensor / actuator level. They don't use additional internal protective circuits and thus are overload-proof against short-time variations like current or voltage peaks.



2CDC 291 045 F0004

Characteristics

- Standard Pcb relays
- 9 different rated control supply voltages U_s :
DC versions: 12 V, 24 V, 48 V, 110 V
AC versions: 24 V, 48 V, 110 V, 120 V, 230 V
- Output: 1 c/o (SPDT) contact (16 A) or 2 c/o (SPDT) contacts (8 A), 2 c/o (SPDT) contact version optionally equipped with gold contacts
- Cadmium-free contact material
- Suited for logical and standard sockets
- Width on socket: 15.5 mm (0.610 in)
- Pluggable function modules: reverse polarity protection/ free wheeling diode, LED indication, RC elements, overvoltage protection

Approvals

-  ANSI/UL 508
-  CAN/CSA C22.2 No.14
-  CAN/CSA C22.2 No.14
-  VDE
-  EAC
-  CCC
-  RMRS

Marks

-  CE CE

Order data

Packing unit = 10 pieces

1 c/o (SPDT) contact: 250 V, 16 A

Type	Rated control supply voltage U_s	Order code
CR-P012DC1	12 V DC	1SVR 405 600 R4000
CR-P024DC1	24 V DC	1SVR 405 600 R1000
CR-P048DC1	48 V DC	1SVR 405 600 R6000
CR-P110DC1	110 V DC	1SVR 405 600 R8000
CR-P024AC1	24 V AC	1SVR 405 600 R0000
CR-P048AC1	48 V AC	1SVR 405 600 R5000
CR-P110AC1	110 V AC	1SVR 405 600 R7000
CR-P120AC1	120 V AC	1SVR 405 600 R2000
CR-P230AC1	230 V AC	1SVR 405 600 R3000

2 c/o (SPDT) contacts: 250 V, 8 A

CR-P012DC2	12 V DC	1SVR 405 601 R4000
CR-P024DC2	24 V DC	1SVR 405 601 R1000
CR-P048DC2	48 V DC	1SVR 405 601 R6000
CR-P110DC2	110 V DC	1SVR 405 601 R8000
CR-P024AC2	24 V AC	1SVR 405 601 R0000
CR-P048AC2	48 V AC	1SVR 405 601 R5000
CR-P110AC2	110 V AC	1SVR 405 601 R7000
CR-P120AC2	120 V AC	1SVR 405 601 R2000
CR-P230AC2	230 V AC	1SVR 405 601 R3000

2 c/o (SPDT) with gold contacts: 250 V, 8 A

CR-P024DC2G	24 V DC	1SVR 405 606 R1000
CR-P024AC2G	24 V AC	1SVR 405 606 R0000
CR-P110AC2G	110 V AC	1SVR 405 606 R7000
CR-P230AC2G	230 V AC	1SVR 405 606 R3000

Accessories

Function modules

Type	Rated control supply voltage U_s	Version	Order code
Diode - Reverse polarity protection			
CR-P/M 22	6-220 V DC	A1+, A2-	1SVR 405 651 R0000
Diode and LED - Reverse polarity protection			
CR-P/M 42	6-24 V DC	red, A1+, A2-	1SVR 405 652 R0000
CR-P/M 42V	6-24 V DC	green, A1+, A2-	1SVR 405 652 R1000
CR-P/M 42B	24-60 V DC	red, A1+, A2-	1SVR 405 652 R4000
CR-P/M 42BV	24-60 V DC	green, A1+, A2-	1SVR 405 652 R4100
CR-P/M 42C	110 V DC	red, A1+, A2-	1SVR 405 652 R9000
CR-P/M 42CV	110 V DC	green, A1+, A2-	1SVR 405 652 R9100
RC element - Arc elimination			
CR-P/M 52B	6-24 V AC/DC		1SVR 405 653 R0000
CR-P/M 52D	24-60 V AC/DC		1SVR 405 653 R4000
CR-P/M 52C	110-230 V AC/DC		1SVR 405 653 R1000
Diode and LED			
CR-P/M 62	6-24 V AC/DC	red, for DC: A1+, A2-	1SVR 405 654 R0000
CR-P/M 62V	6-24 V AC/DC	green, for DC: A1+, A2-	1SVR 405 654 R1000
CR-P/M 62E	24-60 V AC/DC	red, for DC: A1+, A2-	1SVR 405 654 R4000
CR-P/M 62EV	24-60 V AC/DC	green, for DC: A1+, A2-	1SVR 405 654 R4100
CR-P/M 92	110-230 V AC/ 110 V DC	red, for DC: A1+, A2-	1SVR 405 654 R0100
CR-P/M 92V	110-230 V AC/ 110 V DC	green, for DC: A1+, A2-	1SVR 405 654 R1100
Varistor and LED - Overvoltage protection			
CR-P/M 62C	6-24 V AC/DC	red, for DC: A1+, A2-	1SVR 405 655 R0000
CR-P/M 62CV	6-24 V AC/DC	green, for DC: A1+, A2-	1SVR 405 655 R1000
CR-P/M 62D	24-60 V AC/DC	red, for DC: A1+, A2-	1SVR 405 655 R4000
CR-P/M 62DV	24-60 V AC/DC	green, for DC: A1+, A2-	1SVR 405 655 R4100
CR-P/M 92C	110-230 V AC/ 110 V DC	red, for DC: A1+, A2-	1SVR 405 655 R0100
CR-P/M 92CV	110-230 V AC/ 110 V DC	green, for DC: A1+, A2-	1SVR 405 655 R1100
Varistor - Overvoltage protection			
CR-P/M 72	24 V AC		1SVR 405 656 R0000
CR-P/M 72A	115 V AC		1SVR 405 656 R1000
CR-P/M 82	230 V AC		1SVR 405 656 R2000

Sockets

Type	Version	Connection	Order code
Logical sockets			
CR-PLS	with protective separation	screw	1SVR 405 650 R0000
CR-PLSx		screw	1SVR 405 650 R0100
CR-PLC		spring	1SVR 405 650 R0200
Standard socket			
CR-PSS		screw	1SVR 405 650 R1000
Accessories for CR-P sockets			
CR-PH	Plastic holder		1SVR 405 659 R0000
CR-PJ	Jumper bar for sockets with screw connection		1SVR 405 658 R5000
Markers			
CR-PM	Marker		1SVR 405 658 R0000

Functions

Operating controls

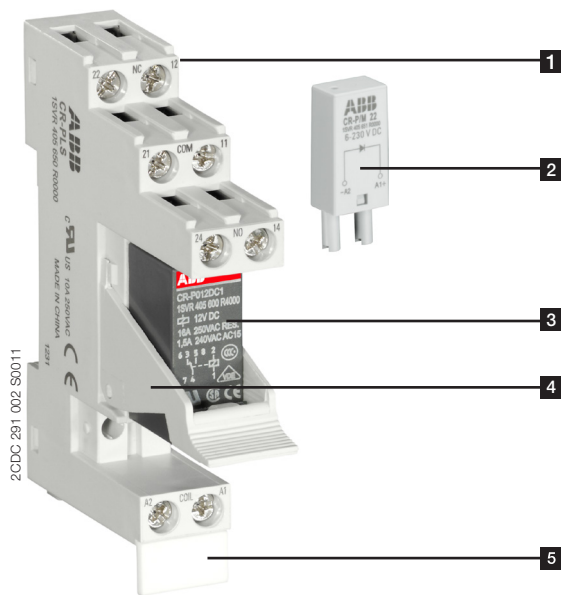

- 1 Socket
- 2 Pluggable function module
- 3 Interface relay
- 4 Holder
- 5 Marker label

Application

Interface relays are electromechanic and electronic input and output modules for electrical isolation, levelling, noise suppression or signal amplification between control unit and process.

Operating mode

When control supply voltage is applied, the output contacts get closed. When control supply voltage is switched off, the contacts fall back into their starting position.

Electrical connection

CR-P with 1 c/o (SPDT) contact

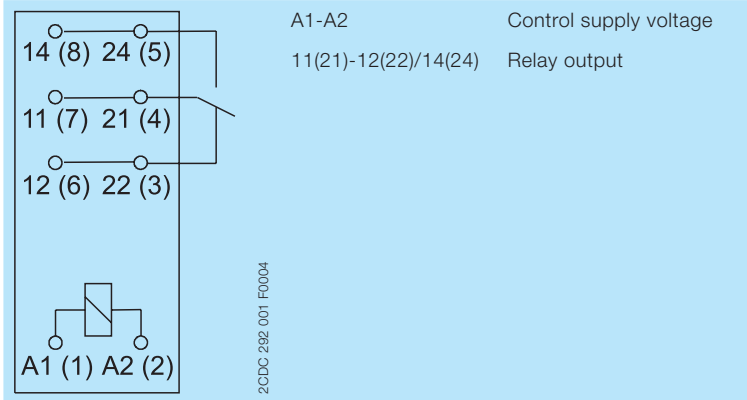

Connection diagram

CR-P with 2 c/o (SPDT) contacts

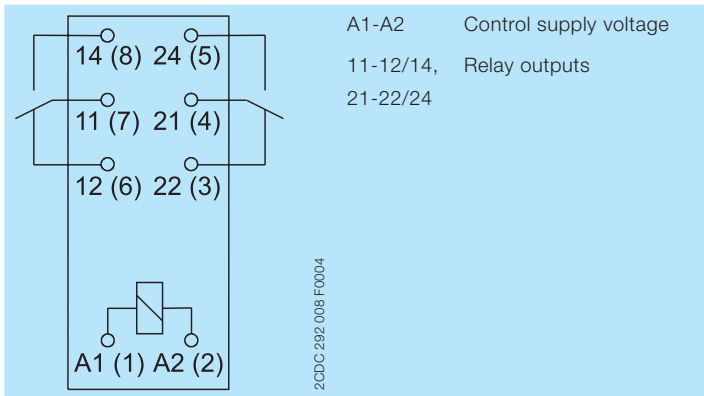

Connection diagram

Technical data

Input circuit - Supply circuit A1-A2

	Rated control supply voltage U_s	Rated frequency	Make voltage (at 20 °C)	Maxium voltage (at 55 °C)	Break voltage	Rated power	Coil resistance (at 20 °C)	Tolerance of coil resistance
DC coils	12 V DC	-	8.4 V DC	30.6 V DC	0.1 U_s	0.4-0.48 W	360 Ω	10 %
	24 V DC	-	16.8 V DC	61.2 V DC	0.1 U_s	0.4-0.48 W	1440 Ω	10 %
	48 V DC	-	33.6 V DC	122.4 V DC	0.1 U_s	0.4-0.48 W	5700 Ω	10 %
	110 V DC	-	77.0 V DC	280.0 V DC	0.1 U_s	0.4-0.48 W	25200 Ω	10 %
AC Coils	24 V AC	50/60 Hz	19.2 V AC	28.8 V AC	0.15 U_s	0.75 VA	400 Ω	10 %
	48 V AC	50/60 Hz	38.4 V AC	57.6 V AC	0.15 U_s	0.75 VA	1550 Ω	10 %
	110 V AC	50/60 Hz	88.0 V AC	132.0 V AC	0.15 U_s	0.75 VA	8900 Ω	10 %
	120 V AC	50/60 Hz	96.0 V AC	144.0 V AC	0.15 U_s	0.75 VA	10200 Ω	10 %
	230 V AC	50/60 Hz	184.0 V AC	276.0 V AC	0.15 U_s	0.75 VA	38500 Ω	10 %

Output circuits

Type	CR-P..1		CR-P..2	
Output circuit(s) - Relay contact(s)	11-12/14		11-12/14, 21-22/24	
Kind of output	Relay, 1 c/o (SPDT) contact		Relay, 2 c/o (SPDT) contacts	
Contact material	AgNi		AgNi AgNi/Au 5 μ m	
Rated operational voltage U_o (IEC/EN 60947-1)	250 V			
Minimum switching voltage	5 V			
Maximum switching voltage	300 V DC / 440 V AC			
Minimum switching current	5 mA (AgNi), 2 mA (AgNi/Au)			
Rated free air thermal current I_{th}	16 A		8 A	
Rated operational current (IEC/EN 60947-5-1)	AC-12 (resistive)	230 V	16 A	8 A
	AC-15 (inductive)	230 V	1.5 A	1.5 A
	AC-15 (inductive)	120 V	3 A	3 A
	DC-12 (resistive)	24 V	16 A	8 A
	DC-13 (inductive)	24 V	2.5 A	2 A
	DC-13 (inductive)	120 V	0.22 A	0.22 A
	DC-13 (inductive)	250 V	0.1 A	0.1 A
AC rating * (UL 508; NEMA ICS-5)	Utilization category (pilot duty) (Contact rating code designation)	B300		
	Max. rated operational voltage	300 V AC		
	Max. continuous thermal current at utilization category	5 A		
	Max. making / breaking apparent power at utilization category	3600 / 360 VA		
	Utilization category (resistive) (CSA22.2 No.14....)	16 A, 250 V AC	8 A, 250 V AC	
DC rating * (UL 508; NEMA ICS-5)	Utilization category (pilot duty) (Contact rating code designation)	R300		
	Max. rated operational voltage	300 V DC		
	Max. continuous thermal current at utilization category	1 A		
	Max. making / breaking apparent power at utilization category	28 VA		
	Utilization category (resistive) (CSA22.2 No.14....)	-	10 A, 24 V DC	
Maximum making (inrush) current	30 A		15 A	
Minimum switching power	0.3 W (AgNi), 0.05 W (AgNi/Au)			

Type		CR-P..1	CR-P..2
Maximum switching (breaking) power	AC-1 (resistive)	4000 VA	2000 VA
Contact resistance		≤ 100 mΩ	
Maximum operating frequency	rated load AC-1	600 switching cycles/h	
	without load	72000 switching cycles/h	
Mechanical lifetime		> 3 x 10 ⁷ switching cycles	
Electrical lifetime	AC-1 (resistive)	> 0.7 x 10 ⁵ switching cycles (16 A, 250 V)	> 10 ⁵ switching cycles (8 A, 250 V)
	cos φ	see reduction factor F	
Response time		typ. 7 ms	
Release time		typ. 3 ms	

*) Those ratings are based on different type tests but they are not covered by the cULus or CSA approvals

Isolation data

Type		CR-P..1	CR-P..2
Rated insulation voltage		400 V AC	
Insulation class		C250 / B400	
Rated impulse withstand voltage U _{imp}	between coil and contacts	5 kV AC	
	between open contacts	1 kV AC	
	between c/o (SPDT) contacts	-	2.5 kV AC
Clearance	between coil and contacts	≥ 10 mm	
Creepage distance	between coil and contacts	≥ 10 mm	
Overtoltage category		III	
Pollution degree		3	

General data

Type		CR-P..1	CR-P..2
Dimensions (W x H x D) when mounted		12.7 x 29 x 15.7 mm (0.500 x 1.142 x 0.618 in)	
Weight		14 g (0.031 lb)	
Type of connection		by socket	
Mounting		on socket (see accessories)	
Mounting position		any	
Degree of protection		IP 67	

Environmental data

Type		CR-P..1	CR-P..2
Ambient temperature range	operation	DC: -40...+85 °C; AC: -40...+70 °C	
	storage	-40...+85 °C	
Vibration resistance (10-150 Hz)	n/o contact	10 g	
	n/c contact	10 g	5 g
Shock resistance	n/o contact	30 g	20 g
	n/c contact	30 g	20 g

Standards

Type		CR-P..1	CR-P..2
Product standard		IEC/EN 60255-23, IEC/EN 60664-1, IEC/EN 61810-1	
Low Voltage Directive		2006/95/EC	

Technical diagrams

Operating range of coils

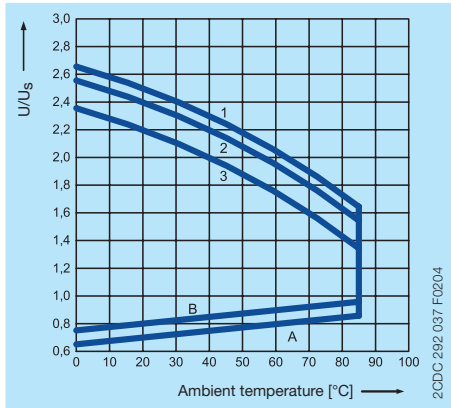

Operating range of DC coil

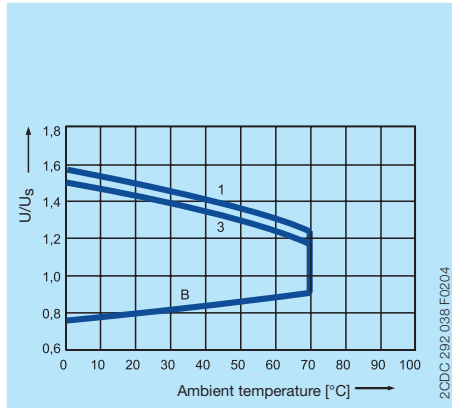

Operating range of AC coil

- A unloaded contacts, coil temperature = ambient temperature
- B continued with I_{th} (16 A at CR-P ... 1 and 8 A at CR-P ... 2) loaded contacts coil heated with $1,1 \times U_s$
- 1 at unloaded contacts
- 2 at 50 % rated load
- 3 at rated load

Load limit curves - Electrical lifetime at resistive AC load

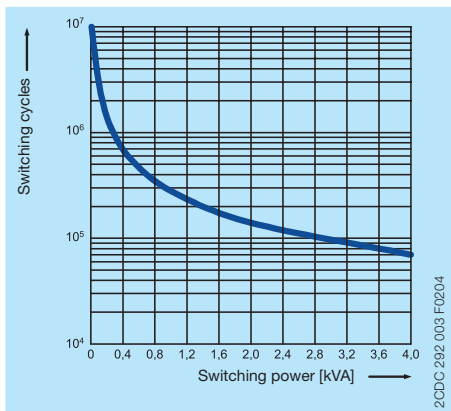

Versions with 1 c/o (SPDT) contact (CR-P ... 1)

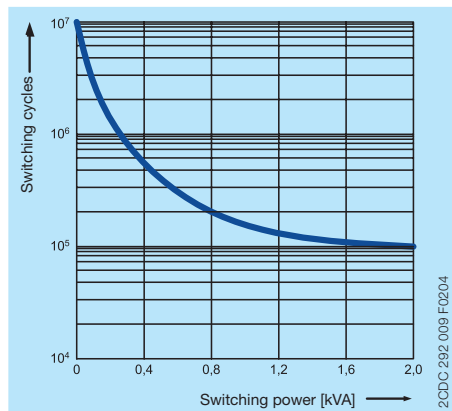

Versions with 2 c/o (SPDT) contacts (CR-P ... 2)

Load limit curves - Maximum switching power at resistive DC load

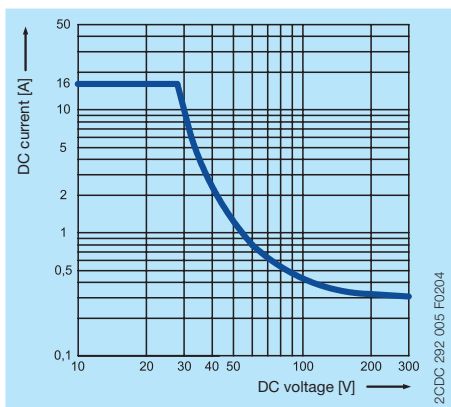

Versions with 1 c/o (SPDT) contact (CR-P ... 1)

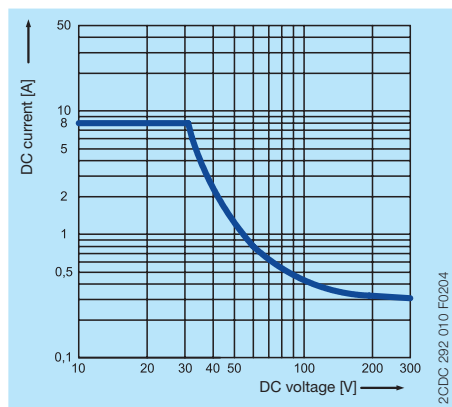

Versions with 2 c/o (SPDT) contacts (CR-P ... 2)

Reduction factor F at inductive AC load

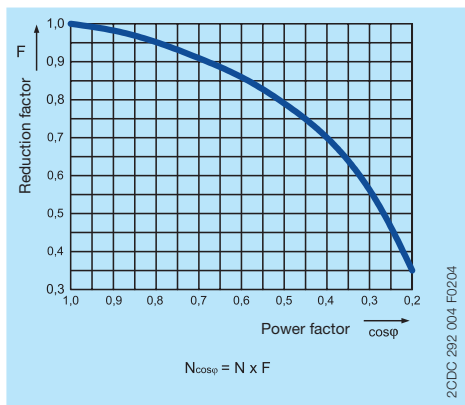

Versions with 1 or 2 c/o (SPDT) contacts
(CR-P ... 1 and CR-P ... 2)

Dimensions

in mm

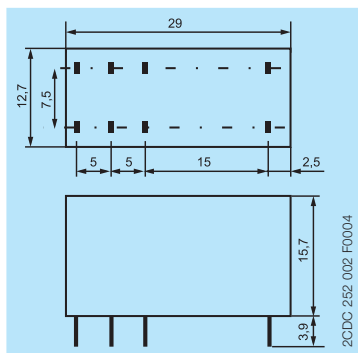

Further documentation

Document title	Document type	Document number
Electronic Products and Relays	Technical catalogue	2CDC 110 004 C02xx
Sockets CR-P	Data sheet	2CDC 117 004 D020x
Jumper bar CR-PJ	Data sheet	2CDC 117 015 D020x
Pluggable function modules CR-P/M	Data sheet	2CDC 117 007 D020x

You can find the documentation on the internet at www.abb.com/lowvoltage -> Control Products -> Electronic Relays and Controls -> Interface Relays and Optocouplers.

CAD system files

You can find the CAD files for CAD systems at

<http://abb-control-products.partcommunity.com/portal/portal/abb-control-products>

-> Low Voltage Products & Systems -> Control Products -> Electronic Relays and Controls

-> Interface Relays and Optocouplers -> CR-P - Pluggable Interface Relays.

Contact us

ABB STOTZ-KONTAKT GmbH

P. O. Box 10 16 80
69006 Heidelberg, Germany
Phone: +49 (0) 6221 7 01-0
Fax: +49 (0) 6221 7 01-13 25
E-mail: info.desto@de.abb.com

You can find the address of your
local sales organization on the
ABB home page
<http://www.abb.com/contacts>
-> Low Voltage Products and Systems

Note:

We reserve the right to make technical changes or modify the contents of this document without prior notice. With regard to purchase orders, the agreed particulars shall prevail. ABB AG does not accept any responsibility whatsoever for potential errors or possible lack of information in this document.

We reserve all rights in this document and in the subject matter and illustrations contained therein. Any reproduction, disclosure to third parties or utilization of its contents – in whole or in parts – is forbidden without prior written consent of ABB AG.

Copyright© 2015 ABB
All rights reserved