

# MAXIM

## +3V to +5.5V, 1.5Mbps RS-232 Receivers in SOT23-5

MAX3180-MAX3183

### General Description

The MAX3180-MAX3183 are single RS-232 receivers in a SOT23-5 package for space- and cost-constrained applications requiring minimal RS-232 communications. These devices minimize power and heat dissipation by consuming only 0.5µA supply current from a +3.0V to +5.5V supply voltage. They guarantee true RS-232 performance up to a 1.5Mbps data rate.

The MAX3180/MAX3182 feature a three-state TTL/CMOS receiver output that is controlled by an  $\overline{EN}$  logic input. The MAX3181/MAX3183 feature an  $\overline{INVALID}$  output that indicates valid RS-232 signals at the receiver input for applications requiring automatic system wake-up. The MAX3180/MAX3181 receivers have a standard inverting output, while the MAX3182/MAX3183 receivers have a noninverting output.

### Applications

Diagnostic Ports	Set-Top Boxes
Telecommunications	Digital Cameras
Networking Equipment	Hand-Held Equipment

### Features

- ◆ Tiny SOT23-5 Package
- ◆ 0.5µA Supply Current
- ◆ 1.5Mbps Guaranteed Data Rate
- ◆ Meet EIA/TIA-232 and V.28/V.24 Specifications Down to  $V_{CC} = +3.0V$
- ◆  $\overline{INVALID}$  Output Indicates Valid RS-232 Signal at Receiver Input (MAX3181/MAX3183)
- ◆ Three-State TTL/CMOS Receiver Output (MAX3180/MAX3182)
- ◆ Noninverting RS-232 Output (MAX3182/MAX3183)

### Ordering Information

PART	TEMP. RANGE	PIN-PACKAGE	TOP MARK
MAX3180EUK-T	-40°C to +85°C	5 SOT23-5	ADKF
MAX3181EUK-T	-40°C to +85°C	5 SOT23-5	ADKG
MAX3182EUK-T	-40°C to +85°C	5 SOT23-5	ADKH
MAX3183EUK-T	-40°C to +85°C	5 SOT23-5	ADKI

### Selector Guide

PART	PACKAGE	SUPPLY CURRENT (µA)	$\overline{EN}$ INPUT	$\overline{INVALID}$ OUTPUT	INVERTING ROUT	NONINVERTING ROUT
MAX3180	SOT23-5	0.5	✓	—	✓	—
MAX3181	SOT23-5	0.5	—	✓	✓	—
MAX3182	SOT23-5	0.5	✓	—	—	✓
MAX3183	SOT23-5	0.5	—	✓	—	✓

### Pin Configurations/Functional Diagrams

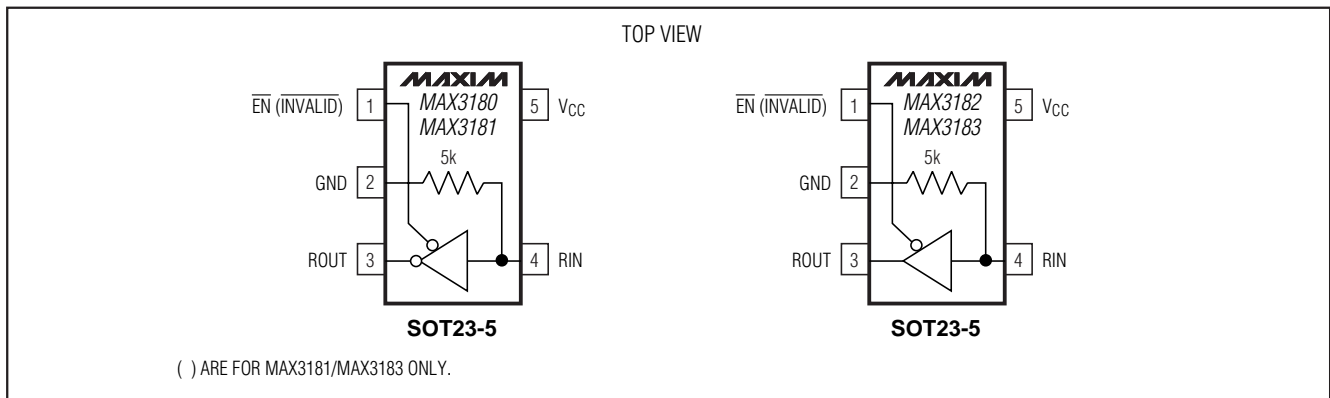

# +3V to +5.5V, 1.5Mbps RS-232 Receivers in SOT23-5

## ABSOLUTE MAXIMUM RATINGS

V<sub>CC</sub> to GND .....-0.3V to +6V  
 R<sub>IN</sub> to GND .....±25V  
 EN, R<sub>OUT</sub>,  $\overline{\text{INVALID}}$  to GND .....-0.3V to (V<sub>CC</sub> + 0.3V)  
 Continuous Power Dissipation (T<sub>A</sub> = +70°C)  
   SOT23-5 (derate 7.1mW/°C above +70°C).....571mW

Operating Temperature Range .....-40°C to +85°C  
 Storage Temperature Range .....-65°C to +150°C  
 Lead Temperature (soldering, 10sec) .....+300°C

Stresses beyond those listed under "Absolute Maximum Ratings" may cause permanent damage to the device. These are stress ratings only, and functional operation of the device at these or any other conditions beyond those indicated in the operational sections of the specifications is not implied. Exposure to absolute maximum rating conditions for extended periods may affect device reliability.

## ELECTRICAL CHARACTERISTICS

(V<sub>CC</sub> = +3.0V to +5.5V, T<sub>A</sub> = T<sub>MIN</sub> to T<sub>MAX</sub>, unless otherwise noted. Typical values are at V<sub>CC</sub> = +5.0V and T<sub>A</sub> = +25°C.) (Note 1)

PARAMETER	SYMBOL	CONDITIONS	MIN	TYP	MAX	UNITS
<b>DC CHARACTERISTICS</b>						
Supply Voltage	V <sub>CC</sub>		3.0		5.5	V
Supply Current	I <sub>CC</sub>	V <sub>CC</sub> = 3.3V or 5V, R <sub>IN</sub> = V <sub>CC</sub> or GND, no load		0.5	5	μA
<b>LOGIC INPUT (<math>\overline{\text{EN}}</math>)</b>						
Logic Threshold Low	V <sub>IL</sub>				0.8	V
Logic Threshold High	V <sub>IH</sub>	V <sub>CC</sub> = 3.3V	2.0			V
		V <sub>CC</sub> = 5.0V	2.4			
Leakage Current	I <sub>EN</sub>			±0.01	±1.0	μA
<b>LOGIC OUTPUT</b>						
$\overline{\text{INVALID}}$ Output Voltage Low	V <sub>IOL</sub>	I <sub>SINK</sub> = 1.6mA			0.4	V
$\overline{\text{INVALID}}$ Output Voltage High	V <sub>IOH</sub>	I <sub>SOURCE</sub> = 1.0mA	V <sub>CC</sub> - 0.6			V
<b>RECEIVER INPUT</b>						
Input Voltage Range	V <sub>RIN</sub>		-25		25	V
Input Threshold Low	V <sub>ITL</sub>	V <sub>CC</sub> = 3.3V	0.6	1.2		V
		V <sub>CC</sub> = 5.0V	0.8	1.5		
Input Threshold High	V <sub>ITH</sub>	V <sub>CC</sub> = 3.3V		1.5	2.4	V
		V <sub>CC</sub> = 5.0V		1.8	2.7	
Input Hysteresis	V <sub>HYST</sub>			300		mV
R <sub>IN</sub> Threshold to $\overline{\text{INVALID}}$ Output High	V <sub>ITOH</sub>	Positive threshold			2.7	V
		Negative threshold	-2.7			
R <sub>IN</sub> Threshold to $\overline{\text{INVALID}}$ Output Low	V <sub>ITOL</sub>		-0.3		0.3	V
Input Resistance	R <sub>RIN</sub>		3	5	7	kΩ
<b>RECEIVER OUTPUT</b>						
Output Leakage Current	I <sub>ROUT</sub>	Receiver disabled		±0.05	±10	μA
Output Voltage Low	V <sub>OL</sub>	I <sub>SINK</sub> = 1.6mA			0.4	V
Output Voltage High	V <sub>OH</sub>	I <sub>SOURCE</sub> = 1.0mA	V <sub>CC</sub> - 0.6	V <sub>CC</sub> - 0.1		V

# +3V to +5.5V, 1.5Mbps RS-232 Receivers in SOT23-5

**MAX3180-MAX3183**

## ELECTRICAL CHARACTERISTICS (continued)

(V<sub>CC</sub> = +3.0V to +5.5V, T<sub>A</sub> = T<sub>MIN</sub> to T<sub>MAX</sub>, unless otherwise noted. Typical values are at V<sub>CC</sub> = +5.0V and T<sub>A</sub> = +25°C.) (Note 1)

PARAMETER	SYMBOL	CONDITIONS	MIN	TYP	MAX	UNITS
<b>TIMING CHARACTERISTICS</b>						
Maximum Data Rate		C <sub>L</sub> = 50pF	1.5			Mbps
Receiver Propagation Delay, High-to-Low	t <sub>PHL</sub>	R <sub>IN</sub> to R <sub>OUT</sub> ; C <sub>L</sub> = 150pF		0.15		μs
Receiver Propagation Delay, Low-to-High	t <sub>PLH</sub>	R <sub>IN</sub> to R <sub>OUT</sub> ; C <sub>L</sub> = 150pF		0.15		μs
Receiver Skew	t <sub>RS</sub>	t <sub>PHL</sub> - t <sub>PLH</sub>  , Figure 1		50		ns
Receiver Output Enable Time	t <sub>ROE</sub>			200		ns
Receiver Output Disable Time	t <sub>ROD</sub>			200		ns
Receiver Positive or Negative Threshold to $\overline{\text{INVALID}}$ High	t <sub>INVH</sub>			250		ns
Receiver Positive or Negative Threshold to $\overline{\text{INVALID}}$ Low	t <sub>INVL</sub>			30		μs

**Note 1:** Specifications are 100% tested at T<sub>A</sub> = +25°C. Limits over temperature are guaranteed by design.

## Typical Operating Characteristics

(V<sub>CC</sub> = +5V, T<sub>A</sub> = +25°C, unless otherwise noted.)

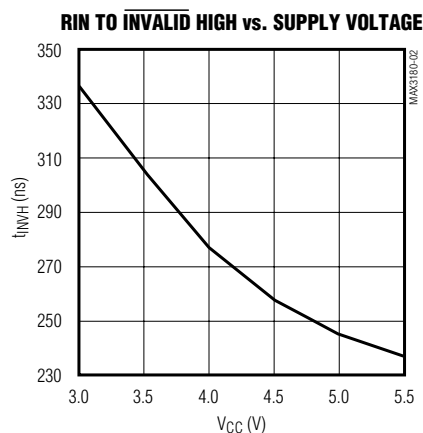
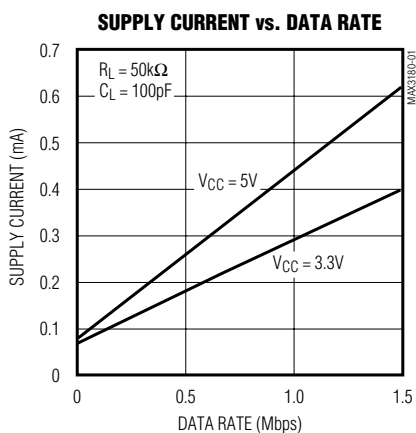

# **+3V to +5.5V, 1.5Mbps RS-232 Receivers in SOT23-5**

## **Typical Operating Characteristics (continued)**

(V<sub>CC</sub> = +5V, T<sub>A</sub> = +25°C, unless otherwise noted.)

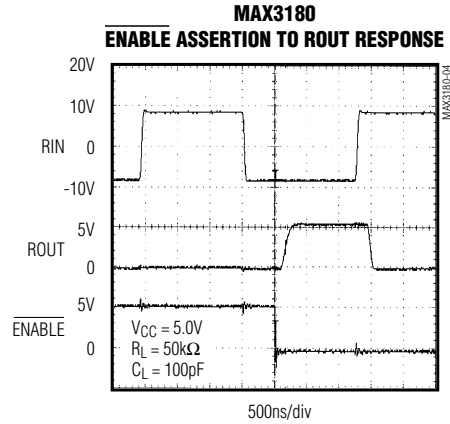
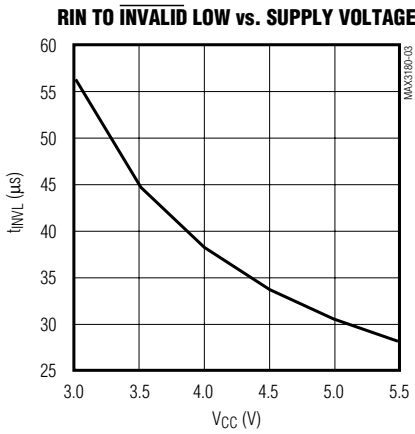

## **Pin Description**

PIN	NAME				FUNCTION
	MAX3180	MAX3181	MAX3182	MAX3183	
1	$\overline{\text{EN}}$	–	$\overline{\text{EN}}$	–	Receiver Output Enable
	–	$\overline{\text{INVALID}}$	–	$\overline{\text{INVALID}}$	Output of the Valid Input Detector
2	GND	GND	GND	GND	Ground
3	ROUT	ROUT	–	–	Inverting Receiver Output
	–	–	ROUT	ROUT	Noninverting Receiver Output
4	RIN	RIN	RIN	RIN	Receiver Input
5	V <sub>CC</sub>	V <sub>CC</sub>	V <sub>CC</sub>	V <sub>CC</sub>	Supply Voltage

# +3V to +5.5V, 1.5Mbps RS-232 Receivers in SOT23-5

## Detailed Description

The MAX3180–MAX3183 are EIA/TIA-232 and V.28/V.24 communications receivers that convert RS-232 signals to CMOS logic levels. The devices operate on a supply voltage of +3V to +5.5V and have a 1.5Mbps data rate capability. They achieve a 0.5μA typical supply current. The MAX3180/MAX3182 have a receiver enable control ( $\overline{EN}$ ), while the MAX3181/MAX3183 contain a signal invalid output ( $\overline{INVALID}$ ). The MAX3180/MAX3181 invert the ROUT signal relative to RIN. The MAX3182/MAX3183 are not inverted. The devices come in SOT23-5 packages.

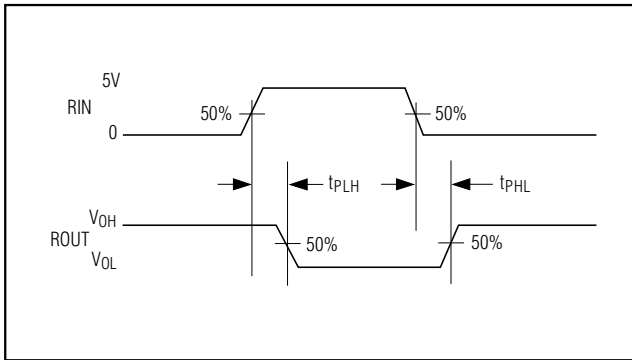

Figure 1. Receiver Propagation-Delay Timing

## Signal Invalid Detector

If no valid signal levels appear on RIN for 30μs (typ),  $\overline{INVALID}$  goes low. This event typically occurs if the RS-232 cable is disconnected or if the connected peripheral transmitter is turned off.  $\overline{INVALID}$  goes high when a valid level is applied to the RS-232 receiver input. Figure 2 shows the input levels and timing diagram for  $\overline{INVALID}$  operation.

## Enable Input

The MAX3180/MAX3182 feature an enable input. Drive  $\overline{EN}$  high to force ROUT into a high-impedance state. In this state, the devices ignore incoming RS-232 signals. Drive  $\overline{EN}$  low for normal operation.

## Power-Supply Decoupling

In most circumstances, a 0.1μF VCC bypass capacitor is adequate for power-supply decoupling. Connect the bypass capacitor as close to the IC as possible.

## Chip Information

TRANSISTOR COUNT: 41

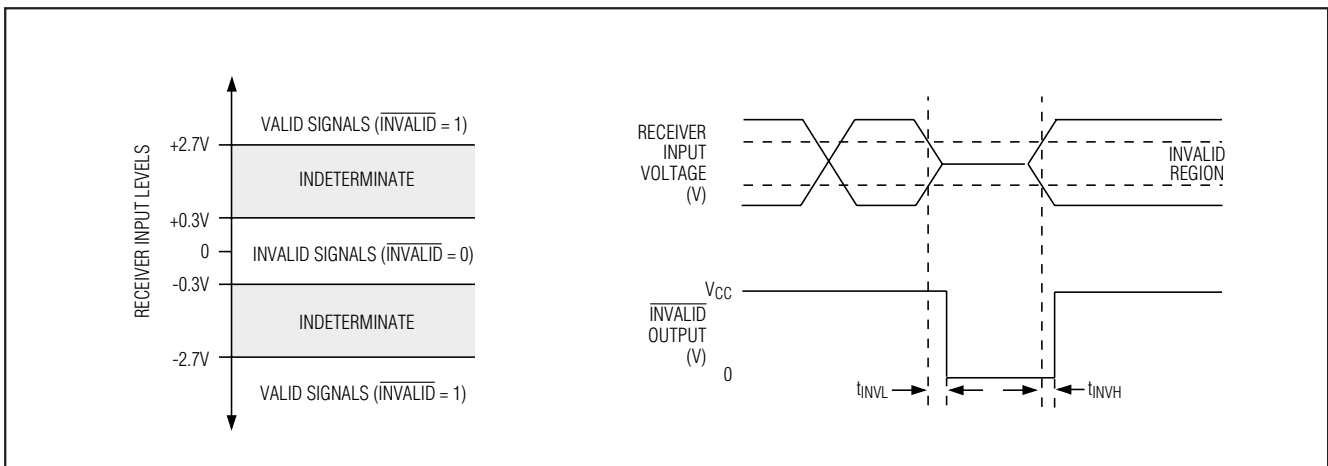
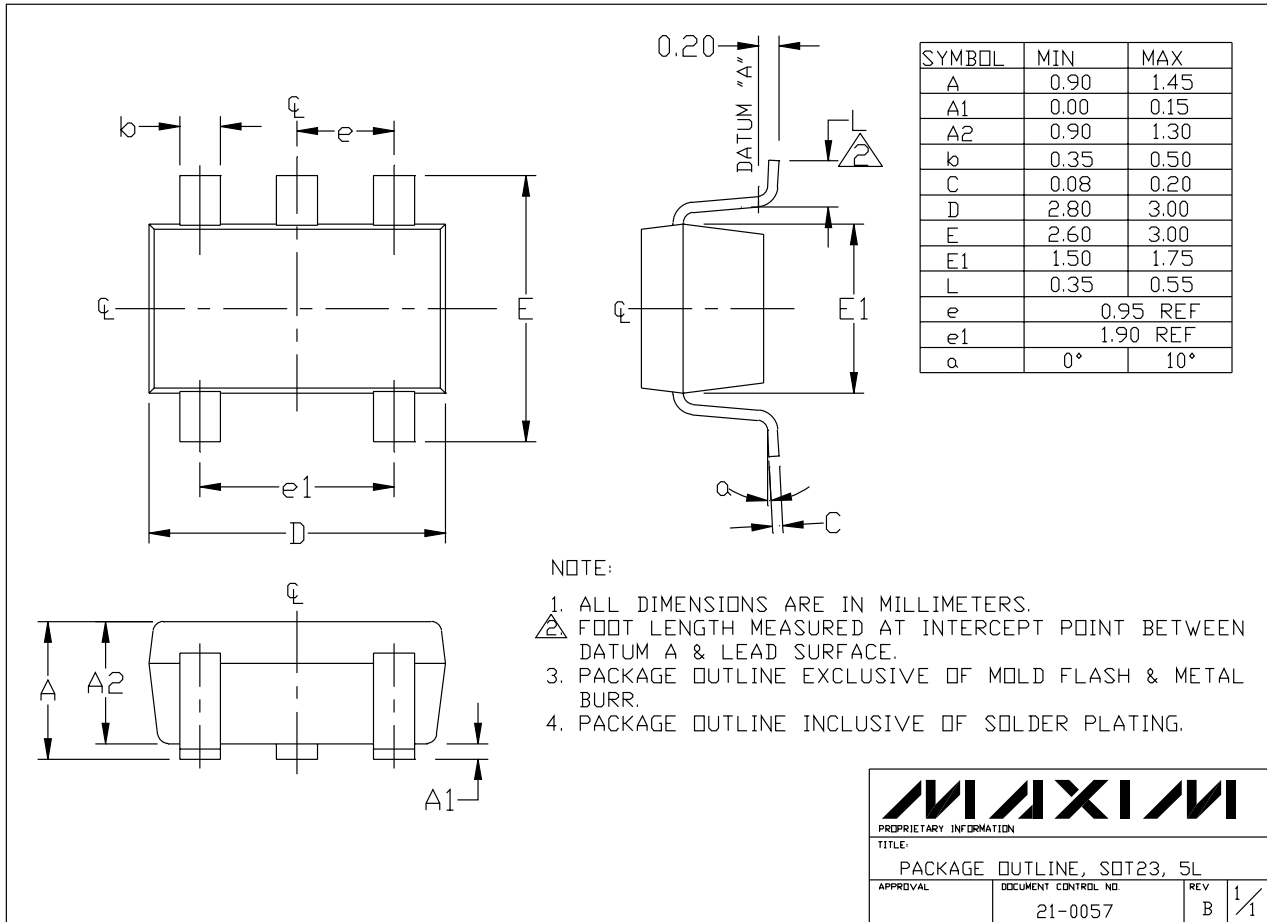

Figure 2. Input Levels and  $\overline{INVALID}$  Timing

**+3V to +5.5V, 1.5Mbps  
RS-232 Receivers in SOT23-5**

**Package Information**



**MAXIM**  
 PROPRIETARY INFORMATION  
 TITLE:  
 PACKAGE OUTLINE, SOT23, 5L  
 APPROVAL: \_\_\_\_\_ DOCUMENT CONTROL NO. 21-0057 REV B 1/1

Maxim cannot assume responsibility for use of any circuitry other than circuitry entirely embodied in a Maxim product. No circuit patent licenses are implied. Maxim reserves the right to change the circuitry and specifications without notice at any time.

6 Maxim Integrated Products, 120 San Gabriel Drive, Sunnyvale, CA 94086 408-737-7600

# Mouser Electronics

Authorized Distributor

Click to View Pricing, Inventory, Delivery & Lifecycle Information:

[Maxim Integrated:](#)

[MAX3180EUK+T](#) [MAX3181EUK+T](#) [MAX3182EUK+T](#)