

**Mini, 7/8"-Round-Plug Connector, Double-Ended Cordsets, US Color Code**

RSRK 201...601A | RSRKW 201...601A



**2-, 3-, 4-, 5-, and 6-Poles**

Mini, 7/8" double-ended cordsets, male to female straight, 2-, 3-, 4-, 5-, and 6-poles with molded cable, US color code.

**RSRK**

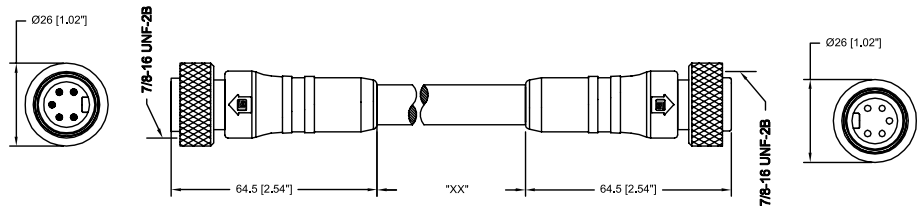

Mini, 7/8" double-ended cordsets, male straight to female 90°, 2-, 3-, 4-, 5-, and 6-poles with molded cable, US color code.

**RSRKW**

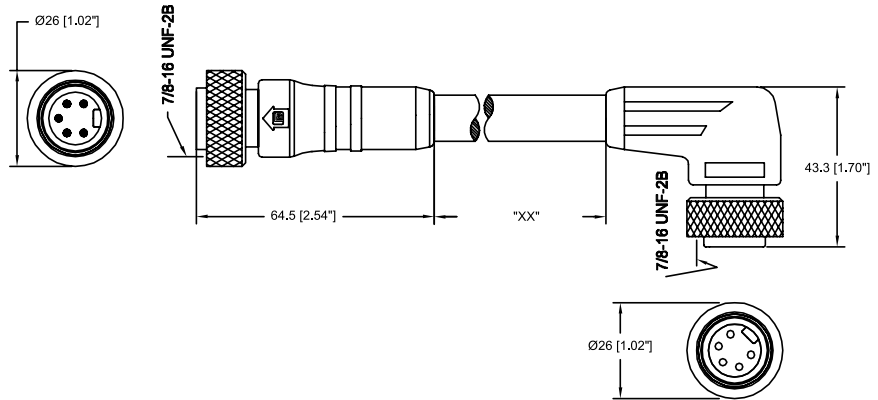

**Pin Assignments**

Mini, 7/8" - Male / Female

**2 poles**

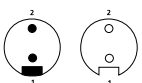

1 = white  
2 = black

**3 poles**

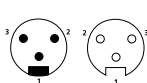

1 = green  
2 = black  
3 = white

**4 poles**

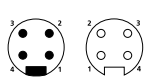

1 = black  
2 = white  
3 = red  
4 = green

**5 poles**

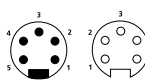

1 = white  
2 = red  
3 = green  
4 = orange  
5 = black

**6 poles**

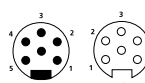

1 = white  
2 = red  
3 = green  
4 = orange  
5 = black  
6 = blue



## Mini, 7/8"-Round-Plug Connector, Double-Ended Cordsets, US Color Code RSRK 201...601A | RSRKW 201...601A

### Technical Data

#### Environmental

Degree of protection IP 67 / NEMA 6P  
Operating temperature range -40°C (-40°F) / +90°C (194°F)

#### Mechanical

Housing / Molded body TPU, yellow  
Insert TPU, yellow  
Contact CuZn, gold over silver plated  
Coupling nut Aluminum, anodized black



























#### Electrical

Current rating 2 pole: 12 A  
3-5 pole: 8 A  
6 pole: 5 A

Voltage rating 600 V

### Cable Specifications - US Color Code

Cable No.	Outer Jacket	Gauge	Jacket Color	OD	Temperature Rating	Agency Approvals
619	CPE	18AWG	Yellow	.370" (9.4 mm)	-40°C (-40°F) to +90°C (194°F)	UL: S00W / CSA: S0W
678	PVC	16AWG	Yellow	.375" (9.5 mm)	-40°C (-40°F) to +105°C (221°F)	UL: ST0W / CSA: ST0
697	PVC	18AWG	Yellow	.502" (12.8 mm)	-40°C (-40°F) to +105°C (221°F)	UL: ST0W / CSA: ST00
738	TPE	16AWG	Yellow	.390" (9.9 mm)	-50°C (-58°F) to +105°C (221°F)	UL: SE00W / CSA: ST00W
739	TPE	16AWG	Yellow	.415" (10.5 mm)	-50°C (-58°F) to +105°C (221°F)	UL: SE00W / CSA: ST00W
777	TPE	16AWG	Yellow	.495" (12.6 mm)	-50°C (-58°F) to +105°C (221°F)	UL: SE00W / CSA: ST00W
839	TPE	16AWG	Yellow	.342" (8.7 mm)	-30°C (-22°F) to +90°C (194°F)	UL: TC-ER
877	TPE	16AWG	Yellow	.371" (9.4 mm)	-30°C (-22°F) to +90°C (194°F)	UL: TC-ER

Part Number	Pins	Outer Jacket	Standard Cable Lengths	Characteristics
RSRK 201-678/...F	2	PVC	6 F / 12 F / 15 F / 20 F / 30 F	  
RSRK 301-619/...F	3	CPE	6 F / 12 F / 15 F / 20 F / 30 F	  
RSRK 301-738/...F	3	TPE	6 F / 12 F / 15 F / 20 F / 30 F	  
RSRK 401-739/...F	4	TPE	6 F / 12 F / 15 F / 20 F / 30 F	  
RSRK 401-839/...M	4	TPE	1 M / 2 M / 3 M / 5 M / 10 M / 20 M	    
RSRK 501-777/...F	5	TPE	6 F / 12 F / 15 F / 20 F / 30 F	  
RSRK 501-877/...M	5	TPE	1 M / 2 M / 3 M / 5 M / 10 M / 20 M	    
RSRK 601A-697/...F	6	PVC	6 F / 12 F / 15 F / 20 F / 30 F	 

# Mouser Electronics

Authorized Distributor

Click to View Pricing, Inventory, Delivery & Lifecycle Information:

## Lumberg Automation:

[RSRK 501-777/100F](#) [RSRK 301-738/3F](#) [RSRK 401-739/70F](#) [RSRK 301-738/15F](#) [RSRK 401-739/30F](#) [RSRK 501-777/50F](#) [RSRK 201-678/30F](#) [RSRK 501-877/20M](#) [RSRK 501-777/6F](#) [RSRK 501-777/36F](#) [RSRK 501-777/3F](#) [RSRK 601A-697/20F](#) [RSRK 401-839/4M](#) [RSRK 501-777/15F](#) [RSRK 401-739/20F](#) [RSRK 401-839/6M](#) [RSRK 401-739/3F](#) [RSRK 301-738/60F](#) [RSRK 301-738/30F](#) [RSRK 401-839/10M](#) [RSRK 401-739/100F](#) [RSRK 401-839/15M](#) [RSRK 601A-697/30F](#) [RSRK 401-739/6F](#) [RSRK 601A-697/12F](#) [RSRK 401-739/80F](#) [RSRK 501-777/1.5F](#) [RSRK 401-839/25M](#) [RSRK 301-619/20F](#) [RSRK 501-777/30F](#) [RSRK 401-839/20M](#) [RSRK 401-739/50F](#) [RSRK 401-739/60F](#) [RSRK 401-739/1.5F](#) [RSRK 401-839/2M](#) [RSRK 501-877/6M](#) [RSRK 301-619/15F](#) [RSRK 401-739/12F](#) [RSRK 601A-697/15F](#) [RSRK 401-839/5M](#) [RSRK 501-877/2M](#) [RSRK 501-877/1M](#) [RSRK 301-619/12F](#) [RSRK 601A-697/6F](#) [RSRK 401-839/1M](#) [RSRK 501-777/12F](#) [RSRK 501-877/10M](#) [RSRK 201-678/12F](#) [RSRK 301-738/12F](#) [RSRK 201-678/20F](#) [RSRK 301-619/6F](#) [RSRK 401-739/15F](#) [RSRK 301-619/30F](#) [RSRK 501-877/3M](#) [RSRK 401-739/40F](#) [RSRK 301-738/20F](#) [RSRK 501-777/20F](#) [RSRK 201-678/15F](#) [RSRK 201-678/6F](#) [RSRK 301-738/6F](#) [RSRK 501-877/5M](#)