

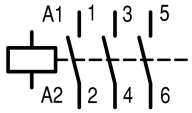

Contactors, 3 pole, 380 V 400 V 22 kW, 400 V 50 Hz, 440 V 60 Hz, AC operation, Screw terminals

Part no. DILM50(400V50HZ,440V60HZ)
Catalog No. 277832
Alternate Catalog No. XTCE050D0013
EL-Nummer (Norway) 4130448

Delivery program

| | | | |
|---|----------------|----|---|
| Product range | | | Contactors |
| Application | | | Contactors for Motors |
| Subrange | | | Contactors up to 170 A, 3 pole |
| Utilization category | | | AC-1: Non-inductive or slightly inductive loads, resistance furnaces AC-3/AC-3e: Normal AC induction motors: Starting, switching off while running AC-4: Normal AC induction motors: starting, plugging, reversing, inching |
| | | |  |
| Notes | | | Also suitable for motors with efficiency class IE3. |
| Connection technique | | | Screw terminals |
| Number of poles | | | 3 pole |
| Rated operational current | | | |
| AC-3 | | | |
| Notes | | | At maximum permissible ambient temperature (open.) Also tested according to AC-3e. |
| 380 V 400 V | I_e | A | 50 |
| AC-1 | | | |
| Conventional free air thermal current, 3 pole, 50 - 60 Hz | | | |
| Open | | | |
| at 40 °C | $I_{th} = I_e$ | A | 80 |
| enclosed | I_{th} | A | 58 |
| Conventional free air thermal current, 1 pole | | | |
| open | I_{th} | A | 162 |
| enclosed | I_{th} | A | 145 |
| Max. rating for three-phase motors, 50 - 60 Hz | | | |
| AC-3 | | | |
| 220 V 230 V | P | kW | 15.5 |
| 380 V 400 V | P | kW | 22 |
| 660 V 690 V | P | kW | 30 |
| AC-4 | | | |
| 220 V 230 V | P | kW | 6 |
| 380 V 400 V | P | kW | 10 |
| 660 V 690 V | P | kW | 14 |
| Contact sequence | | |  |
| Instructions | | | Contacts to EN 50 012. |
| Can be combined with auxiliary contact | | | DILM150-XH(V)... DILM1000-XH(V)... |
| Actuating voltage | | | 400 V 50 Hz, 440 V 60 Hz |
| Voltage AC/DC | | | AC operation |
| Connection to SmartWire-DT | | | no |
| Frame size | | | 3 |

Technical data

General

| | | | |
|---|-------------------------------------|---------------|--|
| Standards | | | IEC/EN 60947, VDE 0660, UL, CSA |
| Lifespan, mechanical | | | |
| AC operated | Operations | $\times 10^6$ | 10 |
| Operating frequency, mechanical | | | |
| AC operated | Operations/h | | 5000 |
| Climatic proofing | | | Damp heat, constant, to IEC 60068-2-78 Damp heat, cyclic, to IEC 60068-2-30 |
| Ambient temperature | | | |
| Open | °C | | -25 - +60 |
| Enclosed | °C | | - 25 - 40 |
| Storage | °C | | - 40 - 80 |
| Mounting position | | |  |
| Mechanical shock resistance (IEC/EN 60068-2-27) | | | |
| Half-sinusoidal shock, 10 ms | | | |
| Main contacts | | | |
| N/O contact | g | | 10 |
| Auxiliary contacts | | | |
| N/O contact | g | | 7 |
| N/C contact | g | | 5 |
| Mechanical shock resistance (IEC/EN 60068-2-27) when tabletop-mounted | | | |
| Half-sinusoidal shock, 10 ms | | | |
| Main contacts | | | |
| N/O contact | g | | 10 |
| Auxiliary contacts | | | |
| N/O contact | g | | 7 |
| N/C contact | g | | 5 |
| Degree of Protection | | | IP00 |
| Protection against direct contact when actuated from front (EN 50274) | | | Finger and back-of-hand proof |
| Altitude | m | | Max. 2000 |
| Weight | | | |
| AC operated | kg | | 0.872 |
| Screw connector terminals | | | |
| Terminal capacity main cable | | | |
| Solid | mm ² | | 1 x (0.75 - 16) 2 x (0.75 - 16) |
| Flexible with ferrule | mm ² | | 1 x (0.75 - 35) 2 x (0.75 - 25) |
| Stranded | mm ² | | 1 x (16 - 50) 2 x (16 - 35) |
| Solid or stranded | AWG | | single 14 - 1, double 14 - 2 |
| Flat conductor | Lamellenzahl x Breite x Dicke | mm | 2 x (6 x 9 x 0.8) |
| Stripping length | mm | | 14 |
| Terminal screw | | | M6 |
| Tightening torque | Nm | | 3.3 |
| Tool | | | |
| Pozidriv screwdriver | Size | | 2 |
| Standard screwdriver | mm | | 0.8 x 5.5 1 x 6 |
| Terminal capacity control circuit cables | | | |

| | | | |
|-----------------------|--|-----------------|--------------------------------------|
| Solid | | mm ² | 1 x (0.75 - 4) 2 x (0.75 - 2.5) |
| Flexible with ferrule | | mm ² | 1 x (0.75 - 2.5) 2 x (0.75 - 2.5) |
| Solid or stranded | | AWG | 18 - 14 |
| Stripping length | | mm | 10 |
| Terminal screw | | | M3.5 |
| Tightening torque | | Nm | 1.2 |
| Tool | | | |
| Pozidriv screwdriver | | Size | 2 |
| Standard screwdriver | | mm | 0.8 x 5.5 1 x 6 |

Main conducting paths

| | | | |
|--|-------------|------|-------|
| Rated impulse withstand voltage | U_{imp} | V AC | 8000 |
| Overvoltage category/pollution degree | | | III/3 |
| Rated insulation voltage | U_i | V AC | 690 |
| Rated operational voltage | U_e | V AC | 690 |
| Safe isolation to EN 61140 | | | |
| between coil and contacts | | V AC | 440 |
| between the contacts | | V AC | 440 |
| Making capacity (p.f. to IEC/EN 60947) | | | |
| | Up to 690 V | A | 700 |
| Breaking capacity | | | |
| 220 V 230 V | | A | 500 |
| 380 V 400 V | | A | 500 |
| 500 V | | A | 500 |
| 660 V 690 V | | A | 320 |
| Short-circuit rating | | | |
| Short-circuit protection maximum fuse | | | |
| Type "2" coordination | | | |
| 400 V | gG/gL 500 V | A | 80 |
| 690 V | gG/gL 690 V | A | 63 |
| Type "1" coordination | | | |
| 400 V | gG/gL 500 V | A | 160 |
| 690 V | gG/gL 690 V | A | 80 |

AC

| | | | |
|---|----------------|---|---|
| AC-1 | | | |
| Rated operational current | | | |
| Conventional free air thermal current, 3 pole, 50 - 60 Hz | | | |
| Open | | | |
| at 40 °C | $I_{th} = I_e$ | A | 80 |
| at 50 °C | $I_{th} = I_e$ | A | 71 |
| at 55 °C | $I_{th} = I_e$ | A | 68 |
| at 60 °C | $I_{th} = I_e$ | A | 65 |
| enclosed | I_{th} | A | 58 |
| Conventional free air thermal current, 1 pole | | | |
| open | I_{th} | A | 162 |
| enclosed | I_{th} | A | 145 |
| AC-3 | | | |
| Rated operational current | | | |
| Open, 3-pole: 50 – 60 Hz | | | |
| Notes | | | At maximum permissible ambient temperature (open.) Also tested according to AC-3e. |
| 220 V 230 V | I_e | A | 50 |
| 240 V | I_e | A | 50 |
| 380 V 400 V | I_e | A | 50 |

| | | | |
|--|----------------|------------------|-----------|
| 415 V | I _e | A | 50 |
| 440V | I _e | A | 50 |
| 500 V | I _e | A | 50 |
| 660 V 690 V | I _e | A | 32 |
| Motor rating | P | kWh | |
| 220 V 230 V | P | kW | 15.5 |
| 240V | P | kW | 17 |
| 380 V 400 V | P | kW | 22 |
| 415 V | P | kW | 30 |
| 440 V | P | kW | 32 |
| 500 V | P | kW | 36 |
| 660 V 690 V | P | kW | 30 |
| AC-4 | | | |
| Open, 3-pole: 50 – 60 Hz | | | |
| 220 V 230 V | I _e | A | 21 |
| 240 V | I _e | A | 21 |
| 380 V 400 V | I _e | A | 21 |
| 415 V | I _e | A | 21 |
| 440 V | I _e | A | 21 |
| 500 V | I _e | A | 21 |
| 660 V 690 V | I _e | A | 17 |
| Motor rating | P | kWh | |
| 220 V 230 V | P | kW | 6 |
| 240 V | P | kW | 6.5 |
| 380 V 400 V | P | kW | 10 |
| 415 V | P | kW | 11 |
| 440 V | P | kW | 12 |
| 500 V | P | kW | 13 |
| 660 V 690 V | P | kW | 14 |
| DC | | | |
| Rated operational current, open | | | |
| DC-1 | | | |
| 60 V | I _e | A | 60 |
| 110 V | I _e | A | 50 |
| 220 V | I _e | A | 45 |
| Current heat loss | | | |
| 3 pole, at I _{th} (60°) | | W | 16.7 |
| Current heat loss at I _e to AC-3/400 V | | W | 9.9 |
| Impedance per pole | | mΩ | 1.9 |
| Magnet systems | | | |
| Voltage tolerance | | | |
| AC operated | Pick-up | x U _c | 0.8 - 1.1 |
| Drop-out voltage AC operated | Drop-out | x U _c | 0.3 - 0.6 |
| Power consumption of the coil in a cold state and 1.0 x U _S | | | |
| 50 Hz | Pick-up | VA | 149 |
| 50 Hz | Sealing | VA | 16 |
| 50 Hz | Sealing | W | 4.1 |
| 60 Hz | Pick-up | VA | 178 |
| 60 Hz | Sealing | VA | 19 |
| 60 Hz | Sealing | W | 4.1 |
| Duty factor | | % DF | 100 |
| Changeover time at 100 % U _S (recommended value) | | | |
| Main contacts | | | |
| AC operated | | | |

| | | |
|---------------|----|---------|
| Closing delay | ms | 12 - 18 |
| Opening delay | ms | 8 - 13 |
| Arcing time | ms | 10 |

Electromagnetic compatibility (EMC)

| | | |
|-----------------------|--|---------------|
| Emitted interference | | to EN 60947-1 |
| Interference immunity | | to EN 60947-1 |

Design verification as per IEC/EN 61439

| Technical data for design verification | | | |
|--|------------|----|--|
| Rated operational current for specified heat dissipation | I_n | A | 50 |
| Heat dissipation per pole, current-dependent | P_{vid} | W | 3.3 |
| Equipment heat dissipation, current-dependent | P_{vid} | W | 9.9 |
| Static heat dissipation, non-current-dependent | P_{vs} | W | 4.1 |
| Heat dissipation capacity | P_{diss} | W | 0 |
| Operating ambient temperature min. | | °C | -25 |
| Operating ambient temperature max. | | °C | 60 |
| IEC/EN 61439 design verification | | | |
| 10.2 Strength of materials and parts | | | |
| 10.2.2 Corrosion resistance | | | |
| | | | Meets the product standard's requirements. |
| 10.2.3.1 Verification of thermal stability of enclosures | | | |
| | | | Meets the product standard's requirements. |
| 10.2.3.2 Verification of resistance of insulating materials to normal heat | | | |
| | | | Meets the product standard's requirements. |
| 10.2.3.3 Verification of resistance of insulating materials to abnormal heat and fire due to internal electric effects | | | |
| | | | Meets the product standard's requirements. |
| 10.2.4 Resistance to ultra-violet (UV) radiation | | | |
| | | | Meets the product standard's requirements. |
| 10.2.5 Lifting | | | |
| | | | Does not apply, since the entire switchgear needs to be evaluated. |
| 10.2.6 Mechanical impact | | | |
| | | | Does not apply, since the entire switchgear needs to be evaluated. |
| 10.2.7 Inscriptions | | | |
| | | | Meets the product standard's requirements. |
| 10.3 Degree of protection of ASSEMBLIES | | | |
| | | | Does not apply, since the entire switchgear needs to be evaluated. |
| 10.4 Clearances and creepage distances | | | |
| | | | Meets the product standard's requirements. |
| 10.5 Protection against electric shock | | | |
| | | | Does not apply, since the entire switchgear needs to be evaluated. |
| 10.6 Incorporation of switching devices and components | | | |
| | | | Does not apply, since the entire switchgear needs to be evaluated. |
| 10.7 Internal electrical circuits and connections | | | |
| | | | Is the panel builder's responsibility. |
| 10.8 Connections for external conductors | | | |
| | | | Is the panel builder's responsibility. |
| 10.9 Insulation properties | | | |
| 10.9.2 Power-frequency electric strength | | | |
| | | | Is the panel builder's responsibility. |
| 10.9.3 Impulse withstand voltage | | | |
| | | | Is the panel builder's responsibility. |
| 10.9.4 Testing of enclosures made of insulating material | | | |
| | | | Is the panel builder's responsibility. |
| 10.10 Temperature rise | | | |
| | | | The panel builder is responsible for the temperature rise calculation. Eaton will provide heat dissipation data for the devices. |
| 10.11 Short-circuit rating | | | |
| | | | Is the panel builder's responsibility. The specifications for the switchgear must be observed. |
| 10.12 Electromagnetic compatibility | | | |
| | | | Is the panel builder's responsibility. The specifications for the switchgear must be observed. |
| 10.13 Mechanical function | | | |
| | | | The device meets the requirements, provided the information in the instruction leaflet (IL) is observed. |

Technical data ETIM 7.0

| | | | |
|---|----|--|-----------|
| Low-voltage industrial components (EG000017) / Power contactor, AC switching (EC000066) | | | |
| Electric engineering, automation, process control engineering / Low-voltage switch technology / Contactor (LV) / Power contactor, AC switching (ecl@ss10.0.1-27-37-10-03 [AAB718015]) | | | |
| Rated control supply voltage U_s at AC 50HZ | V | | 400 - 400 |
| Rated control supply voltage U_s at AC 60HZ | V | | 440 - 440 |
| Rated control supply voltage U_s at DC | V | | 0 - 0 |
| Voltage type for actuating | | | AC |
| Rated operation current I_e at AC-1, 400 V | A | | 80 |
| Rated operation current I_e at AC-3, 400 V | A | | 50 |
| Rated operation power at AC-3, 400 V | kW | | 22 |
| Rated operation current I_e at AC-4, 400 V | A | | 21 |

| | | |
|---|----|------------------|
| Rated operation power at AC-4, 400 V | kW | 10 |
| Rated operation power NEMA | kW | 29.8 |
| Modular version | | No |
| Number of auxiliary contacts as normally open contact | | 0 |
| Number of auxiliary contacts as normally closed contact | | 0 |
| Type of electrical connection of main circuit | | Screw connection |
| Number of normally closed contacts as main contact | | 0 |
| Number of main contacts as normally open contact | | 3 |

Characteristics

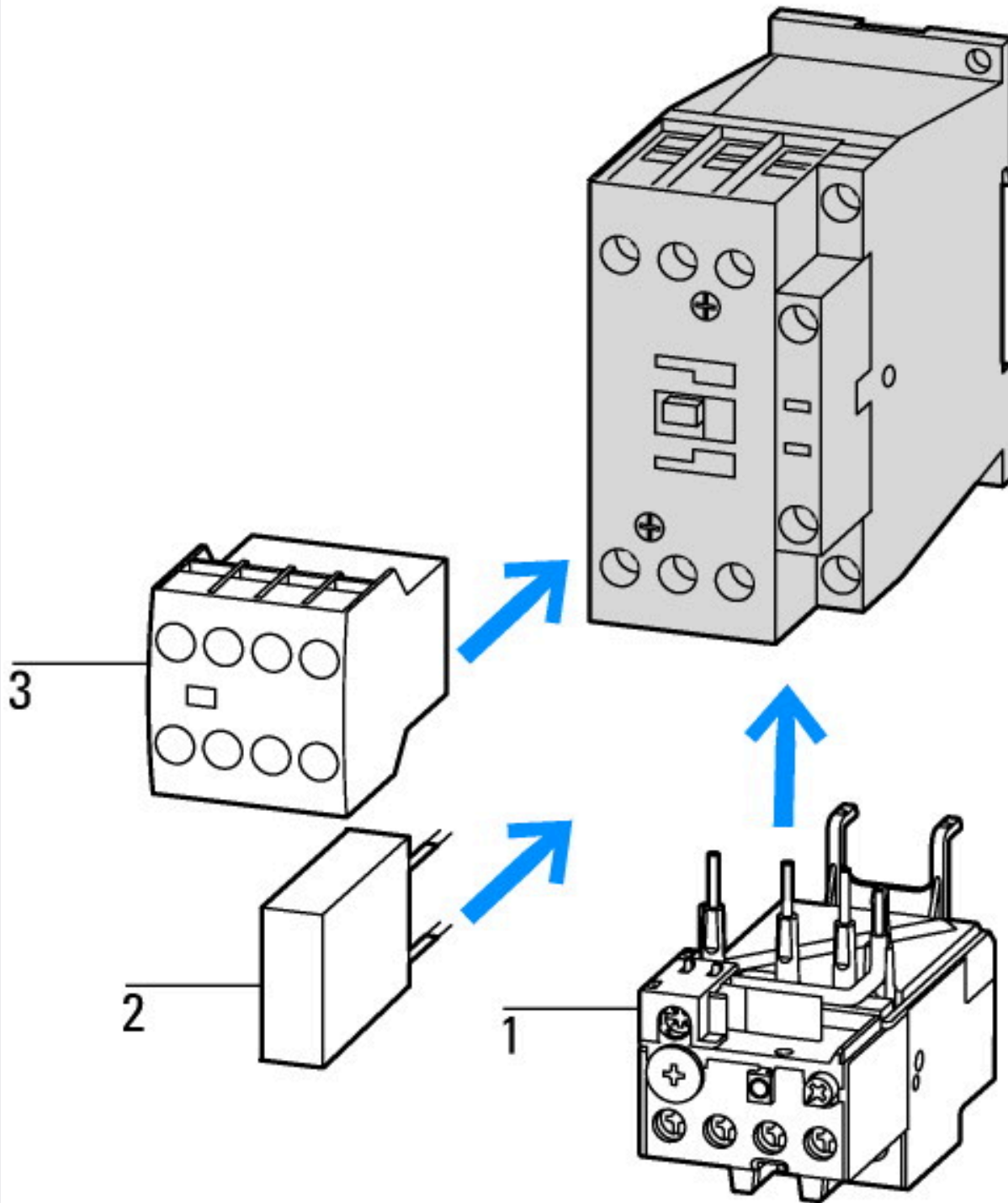

- 1: Overload relay
- 2: Suppressor
- 3: Auxiliary contact modules

DILM1000-XHI(V)11-...

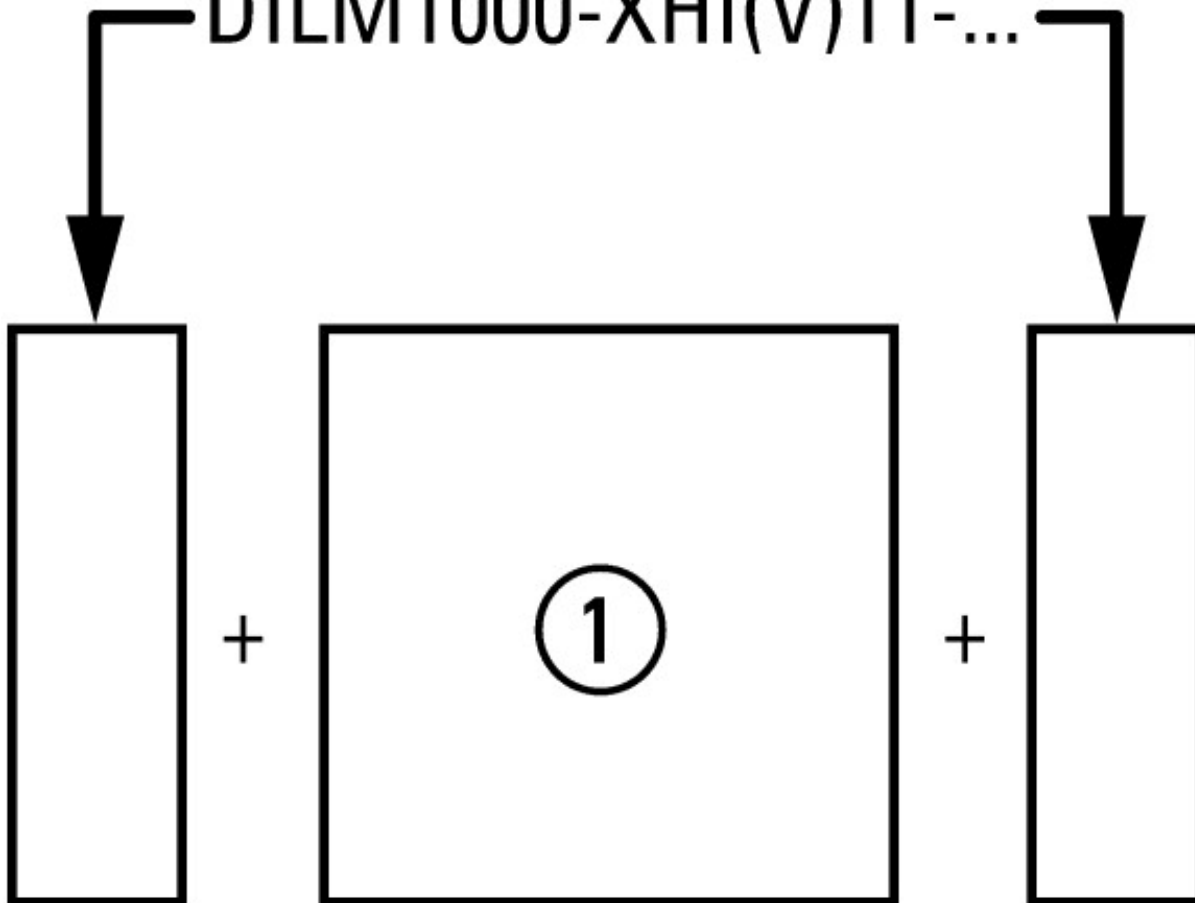

on the side: 2 x DILM1000-XHI(V)11-SI; surface mounting: 1 x DILM150-XHIA11
 on the side: 2 x DILM1000-XHI(V)11-SA; surface mounting: 1 x DILM150-XHI (2 pole)
 on the side: 1 x DILM1000-XHI(V)11-SI; surface mounting: 1 x DILM150-XHIA22
 on the side: 1 x DILM1000-XHI(V)11-SA; surface mounting: 1 x DILM150-XHI (4 pole)

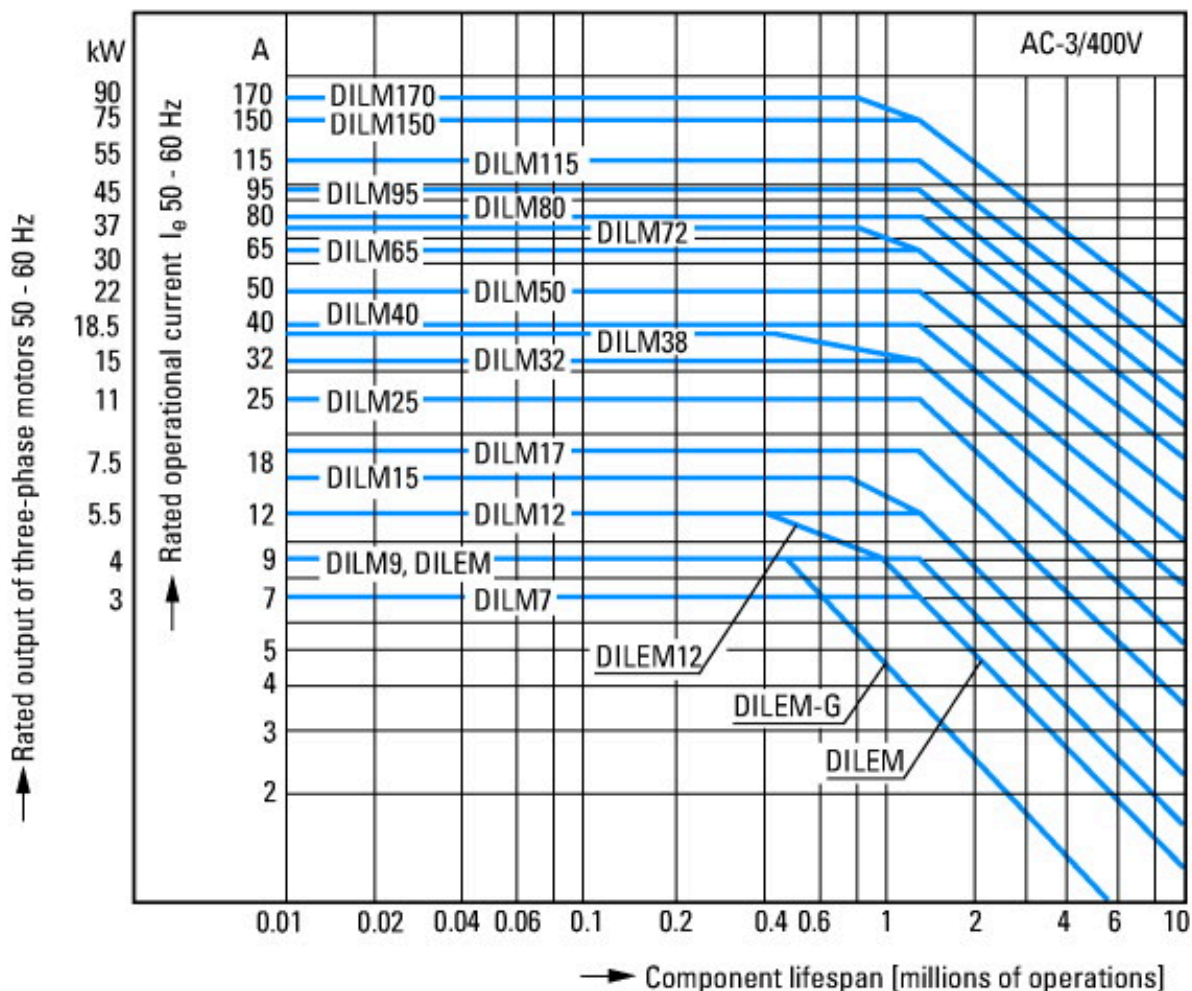

Squirrel-cage motor
 Operating characteristics
 Starting: from rest
 Stopping: after attaining full running speed
 Electrical characteristics
 Make: up to 6 x rated motor current
 Break: up to 1 x rated motor current
 Utilization category
 100 % AC-3
 Typical applications
 Compressors
 Lifts
 Mixers
 Pumps
 Escalators
 Agitators
 Fans
 Conveyor belts
 Centrifuges
 Hinged flaps
 Bucket-elevators
 Air conditioning system
 General drives in manufacturing and processing machines



Extreme switching duty
 Squirrel-cage motor
 Operating characteristics
 Inching, plugging, reversing
 Electrical characteristics
 Make: up to 6 x rated motor current
 Break: up to 6 x rated motor current
 Utilization category
 100 % AC-4
 Typical applications
 Printing presses
 Wire-drawing machines
 Centrifuges
 Special drives for manufacturing and processing machines



Switching conditions for non-motor consumers, 3 pole, 4 pole
 Operating characteristics
 Non inductive and slightly inductive loads
 Electrical characteristics
 Switch on: 1 x rated operational current
 Switch off: 1 x rated operational current
 Utilization category
 100 % AC-1
 Typical examples of application
 Electric heat

Dimensions

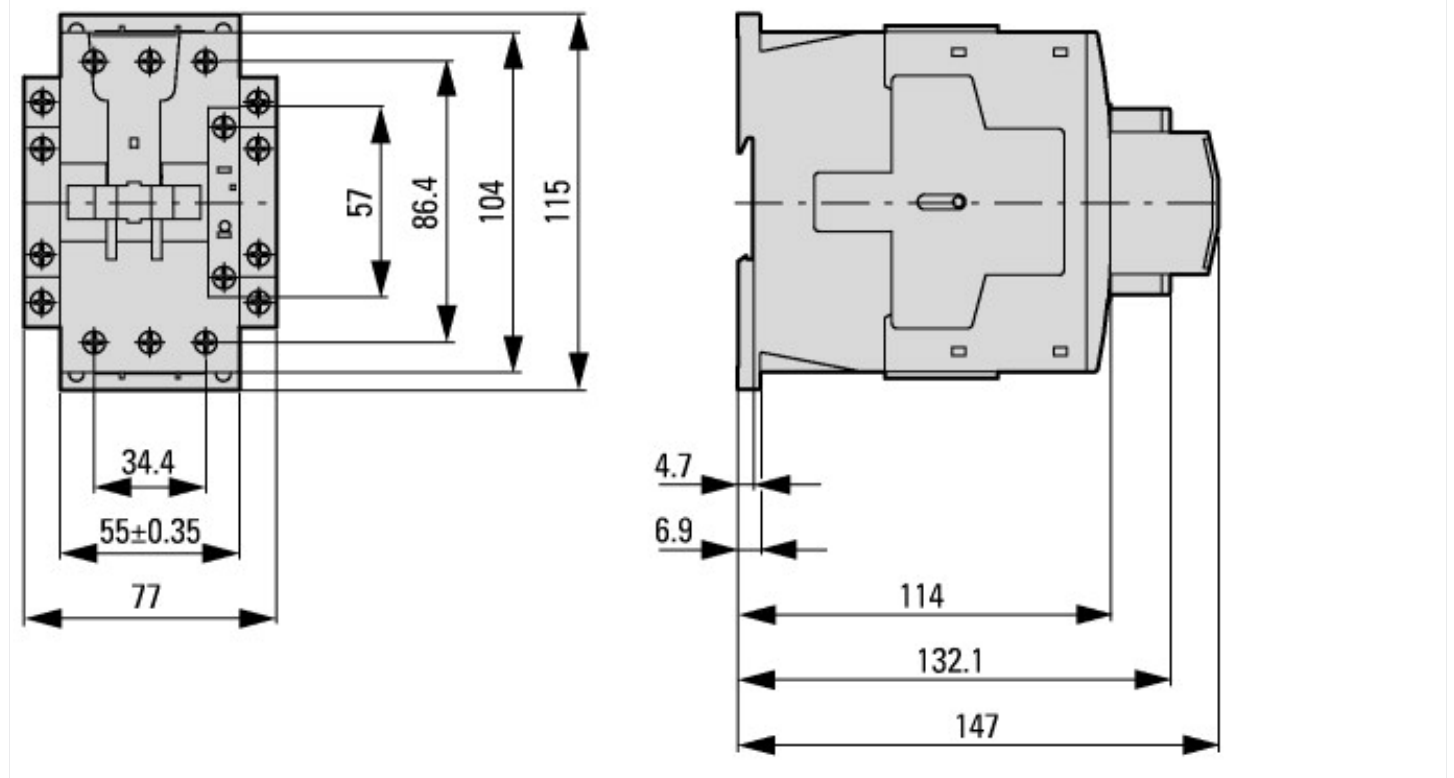

Contacteur with auxiliary contact module

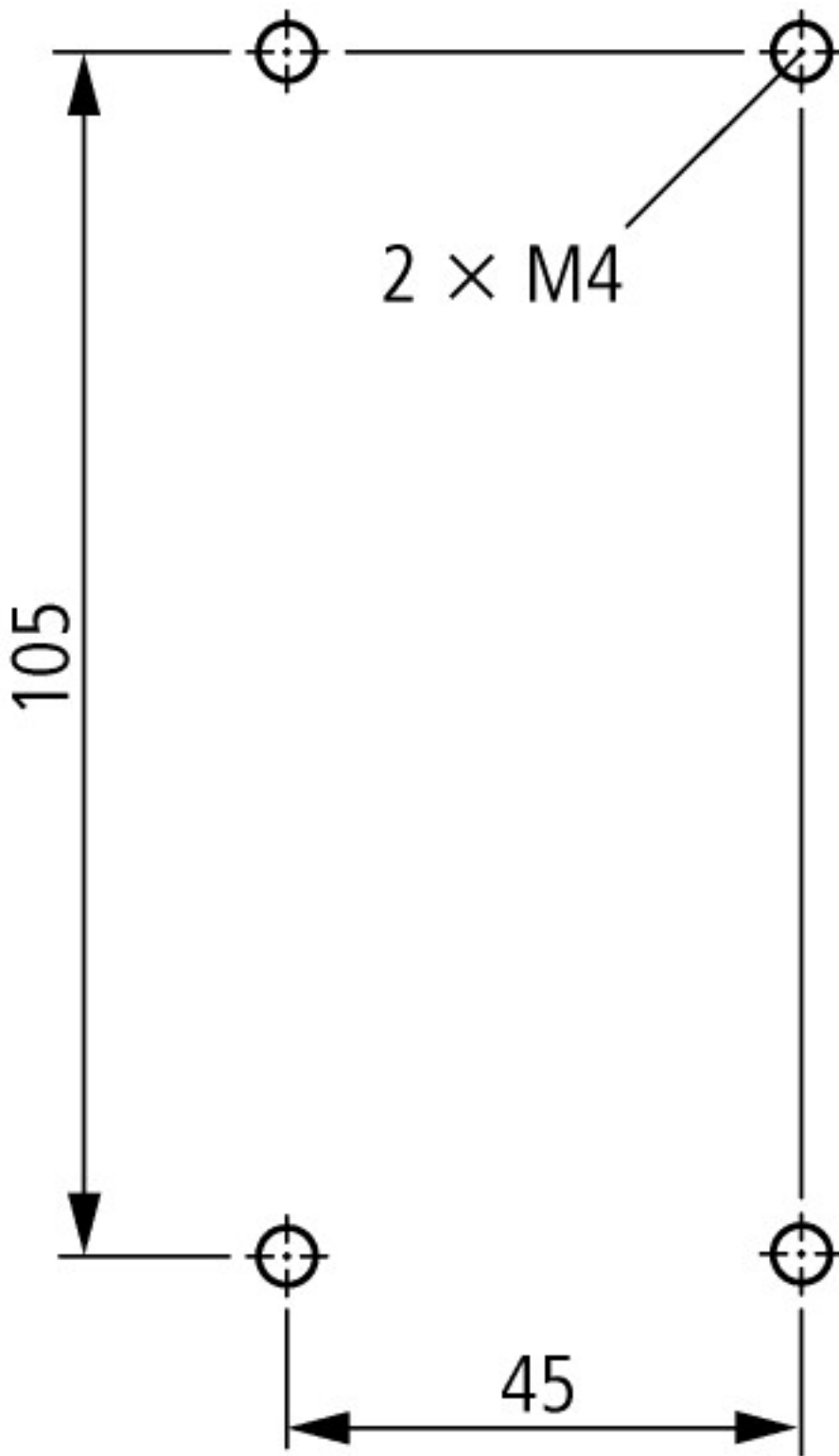

Lateral clearance to earthed parts: 6 mm

DILM40...DILM72
DILMC40...DILMC65
DILMF40...DILMF65