

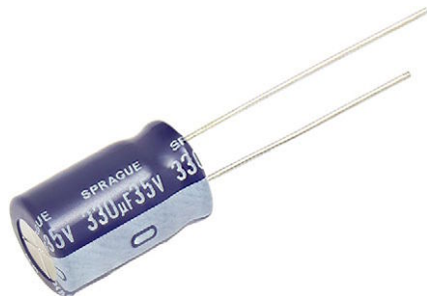

Aluminum Capacitors +85 °C, Miniature, Radial Lead



FEATURES

- High CV per case size
- Low cost
- Material categorization:
for definitions of compliance please see
www.vishay.com/doc?99912



RoHS
COMPLIANT

QUICK REFERENCE DATA	
DESCRIPTION	VALUE
Nominal case size Ø D x L in mm	0.197" x 0.433" [5.0 x 11.0] to 0.709" x 1.575" [18.0 x 40.0]
Operating temperature	-40 °C to +85 °C -25 °C to +85 °C for 315 WV _{DC} to 450 WV _{DC} units
Rated capacitance range, C _R	0.1 µF to 18 000 µF
Tolerance on C _R	± 20 %
Rated voltage range, U _R	6.3 WV _{DC} to 450 WV _{DC}
Termination	2 radial leads
Life validation test at 85 °C	2000 h: ΔCAP ± 20 % from initial measurement. ΔDF 2 x initial specified limit. ΔDCL ≤ initial specified limit.
Shelf life at 85 °C	1000 h: ΔCAP ± 20 % from initial measurement. ΔDF 2 x initial specified limit. ΔDCL ≤ initial specified limit.
DC leakage current	Rated voltage for 1 and 2 min for 6.3 WV _{DC} to 100 WV _{DC} units: I < 0.03 CV or 4 µA (whichever is greater). I < 0.04 CV or 3 µA (whichever is greater). Rated voltage for 1 min for 160 WV _{DC} to 450 WV _{DC} units: I < 0.1 CV + 40 µA and CV ≤ 1000; I < 0.04 CV + 100 µA and CV > 1000

RIPPLE CURRENT MULTIPLIERS						
TEMPERATURE						
AMBIENT TEMPERATURE		MULTIPLIERS				
≤ +70 °C		1.27				
+85 °C		1.0				
FREQUENCY (Hz)						
WV _{DC}	CAP. (µF)	50 TO 60	100 TO 120	300 TO 400	1 kHz	≥ 10 kHz
6.3 to 100	0 to 47	0.75	1	1.35	1.57	2.00
	100 to 470	0.80	1	1.23	1.34	1.50
	1000 to 18 000	0.85	1	1.10	1.13	1.15
160 to 450	0.47 to 220	0.80	1	1.25	1.40	1.60

LOW TEMPERATURE PERFORMANCE		
MAXIMUM IMPEDANCE RATIO Z ^(T) / Z ^(+20 °C)		
MAXIMUM AT 120 Hz		
RATED VOLTAGE (WV _{DC})	Z - 25 °C / Z + 20 °C	Z - 40 °C / Z + 20 °C
6.3	4.0	10.0
10.0	3.0	8.0
16.0	2.0	6.0
25.0	2.0	4.0
35.0 to 100.0	2.0	3.0
160.0 to 200.0	3.0	4.0
250.0	3.0	6.0
315.0 to 400.0	6.0	-
450.0	15.0	-

DIMENSIONS in inches [millimeters]				
CASE CODE	NOMINAL CASE SIZE D x L	LEAD SPACING S	NOMINAL LEAD DIAMETER D	TYPICAL WEIGHT (g)
JA	0.197 x 0.433 [5.0 x 11.0]	0.079 [2.0]	0.020 [0.50]	0.44
AA	0.248 x 0.433 [6.3 x 11.0]	0.098 [2.5]	0.020 [0.50]	0.60
BB	0.315 x 0.453 [8.0 x 11.5]	0.138 [3.5]	0.024 [0.60]	0.95
CC	0.394 x 0.492 [10.0 x 12.5]	0.197 [5.0]	0.024 [0.60]	1.48
CD	0.394 x 0.630 [10.0 x 16.0]	0.197 [5.0]	0.024 [0.60]	1.75
CG	0.394 x 0.787 [10.0 x 20.0]	0.197 [5.0]	0.024 [0.60]	2.37

DIMENSIONS in inches [millimeters]				
CASE CODE	NOMINAL CASE SIZE D x L	LEAD SPACING S	NOMINAL LEAD DIAMETER D	TYPICAL WEIGHT (g)
DG	0.492 x 0.787 [12.5 x 20.0]	0.197 [5.0]	0.024 [0.60]	3.73
DK	0.492 x 0.984 [12.5 x 25.0]	0.197 [5.0]	0.024 [0.60]	4.85
EK	0.630 x 0.984 [16.0 x 25.0]	0.295 [7.5]	0.031 [0.80]	7.08
EN	0.630 x 1.240 [16.0 x 31.5]	0.295 [7.5]	0.031 [0.80]	8.94
ER	0.630 x 1.398 [16.0 x 35.5]	0.295 [7.5]	0.031 [0.80]	10.50
FR	0.709 x 1.398 [18.0 x 35.5]	0.295 [7.5]	0.031 [0.80]	12.53
FV	0.709 x 1.575 [18.0 x 40.0]	0.295 [7.5]	0.031 [0.80]	15.71

ELECTROLYTIC CAPACITOR WITH CUT OR FORMED LEADS in inches [millimeters]

Code F

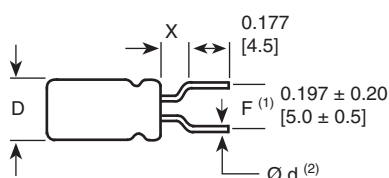

Code S

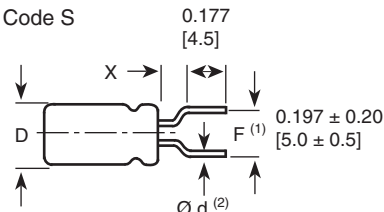

Code S

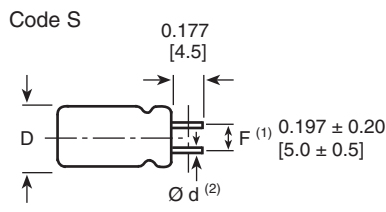

Code C

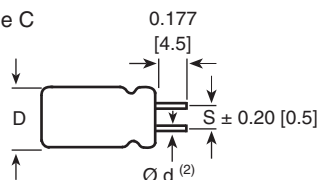

Code S

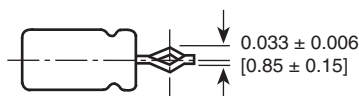

(4, 5, 6.3, 8)

Code S

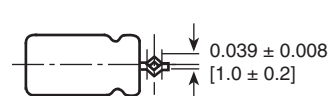

(10, 12.5, 16, 18)

DIMENSIONS in inches [millimeters]						
FORMING METHOD	FORMED LEAD CODE	DIMENSIONS				
		D	L.S.	P	e ⁽³⁾	X (Max.)
Formed and cut	F	0.197 [5.0]	0.197 [5.0]	0.079 [2.0]	-	0.059 [1.5]
		0.248 [6.3]	0.197 [5.0]	0.098 [2.5]	-	0.098 [2.5]
		0.315 [8.0]	0.197 [5.0]	0.138 [3.5]	-	0.098 [2.5]
Cut	C	0.394 [10.0]	0.197 [5.0]	-	-	-
		0.492 [12.5]	0.197 [5.0]	-	-	-
		0.630 [16.0]	0.295 [7.5]	-	-	-
		0.709 [18.0]	0.295 [7.5]	-	-	-
Snap-in	S	0.197 [5.0]	0.197 [5.0]	0.079 [2.0]	0.043 [1.1]	0.059 [1.5]
		0.248 [6.3]	0.197 [5.0]	0.098 [2.5]	0.043 [1.1]	0.059 [1.5]
		0.315 [8.0]	0.197 [5.0]	0.138 [3.5]	0.051 [1.3]	0.059 [1.5]
		0.394 [10.0]	0.197 [5.0]	-	0.051 [1.3]	-
		0.492 [12.5]	0.197 [5.0]	-	0.051 [1.3]	-
		0.630 [16.0]	0.295 [7.5]	-	0.051 [1.3]	-
0.709 [18.0]	0.295 [7.5]	-	0.051 [1.3]	-		

Notes

- Coding of cut or formed lead to be added to the end of type number in 15th position (with position 14 coded "6")
- (1) Formed lead
- (2) Lead thickness Ø d depends on capacitor specification
- (3) Lead protrusion at bottom of tape



TAPED CAPACITORS FOR AUTOMATIC INSERTION SYSTEMS in inches [millimeters]					
PACKAGING	LEAD CODE 14 th AND 15 th DIGITS OF PN	SPECIFICATION		LEAD SPACE	CAPACITOR SIZES AVAILABLE
		LEAD STYLE	+ - LEADER		
Ammo pack	8P	Formed lead ⁽¹⁾	-	0.197 [5.0]	0.197 x 0.433 - 0.492 x 0.787 [5.0 x 11.0 - 12.5 x 20.0] Case codes JA, AA, BB, CC, CD, DG

Notes

- The ammo pack code is to be added at the end of part number in the 14th and 15th position as 8P. To specify formed, cut or snap-in leads and for tape and ammo, both positions 14 and 15 of the type number must be filled in with the proper codes
- ⁽¹⁾ Except 0.394 [10.0 mm] and 0.492 [12.5 mm] diameter have straight unformed leads

TAPING SPECIFICATIONS in inches [millimeters]

Formed Lead Type

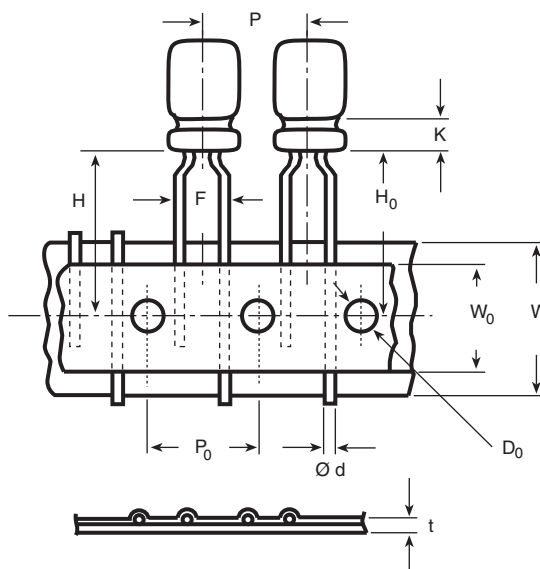

DIMENSIONS in inches [millimeters]					
ITEM	CASE SIZE (Diameter x Length)				
	FORMED LEAD TYPE			STRAIGHT LEAD TYPE	
	0.197 x 0.433 [5.0 x 11.0]	0.248 x 0.433 [6.3 x 11.0]	0.315 x 0.453 [8.0 x 11.5]	0.394 [10.0] (Dia.)	0.492 [12.5] (Dia.)
Ø d - Lead-wire diameter	0.020 [0.5]	0.020 [0.5]	0.024 [0.6]	0.024 [0.6]	0.024 [0.6]
P - Pitch of component	0.500 [12.7]	0.500 [12.7]	0.500 [12.7]	0.500 [12.7]	0.591 [15.0]
P ₀ - Feed hole pitch	0.500 [12.7]	0.500 [12.7]	0.500 [12.7]	0.500 [12.7]	0.591 [15.0]
F - Lead-to-lead distance	0.197 [5.0]	0.197 [5.0]	0.197 [5.0]	0.197 [5.0]	0.197 [5.0]
K - Clinch height	0.098 [2.5]	0.098 [2.5]	0.157 [4.0]	-	-
H - Height of component	0.728 [18.5]	0.728 [18.5]	0.787 [20.0]	0.728 [18.5]	0.630 [16.0]
H ₀ - Lead-wire clinch height	0.630 [16.0]	0.630 [16.0]	0.630 [16.0]	-	-
W - Tape width	0.709 [18.0]	0.709 [18.0]	0.709 [18.0]	0.709 [18.0]	0.709 [18.0]
W ₀ - Hold down tape width	0.512 [13.0]	0.512 [13.0]	0.512 [13.0]	0.512 [13.0]	0.512 [13.0]
D ₀ - Feed hole diameter	0.157 [4.0]	0.157 [4.0]	0.157 [4.0]	0.157 [4.0]	0.157 [4.0]
t - Total tape thickness	0.157 [4.0]	0.157 [4.0]	0.157 [4.0]	0.157 [4.0]	0.157 [4.0]

**ORDERING EXAMPLE**

Electrolytic capacitor 515D series: 515D 107 M 6R3 JA 6 A E3

DESCRIPTION	
CODE	EXPLANATION
515D	Product type
107	Capacitance value (100 μ F)
M	Tolerance (M = \pm 20 %)
6R3	Voltage rating at 85 °C (6R3 = 6.3 V)
JA	Can size (see Dimensions table)
6	Packaging (bulk)
A	Lead style (uncut)
E3	RoHS compliant indicator

PACKING AND LEAD STYLES

6A	Bulk, uncut leads
6C	Bulk, cut leads
6F	Bulk; formed and cut leads
6S	Bulk, snap-in leads
8P	Ammopack (case codes JA, AA, BB, CC, CD, CG, DG only)

ELECTRICAL DATA AND ORDERING INFORMATION				
CAPACITANCE (μ F)	PART NUMBER	NOMINAL CASE SIZE D x L	MAX. RIPPLE AT +85 °C 120 Hz (mA)	MAX. DF AT +20 °C 120 Hz
6.3 WV_{DC} AT +85 °C, SURGE = 8 V				
22.0	515D226M6R3JA6AE3	0.197 x 0.433 [5.0 x 11.0]	34.0	0.24
33.0	515D336M6R3JA6AE3	0.197 x 0.433 [5.0 x 11.0]	42.0	0.24
47.0	515D476M6R3JA6AE3	0.197 x 0.433 [5.0 x 11.0]	50.0	0.24
100.0	515D107M6R3JA6AE3	0.197 x 0.433 [5.0 x 11.0]	77.0	0.24
220.0	515D227M6R3AA6AE3	0.248 x 0.433 [6.3 x 11.0]	215.0	0.24
330.0	515D337M6R3AA6AE3	0.248 x 0.433 [6.3 x 11.0]	265.0	0.24
470.0	515D477M6R3BB6AE3	0.315 x 0.453 [8.0 x 11.5]	360.0	0.24
1000.0	515D108M6R3CC6AE3	0.394 x 0.492 [10.0 x 12.5]	570.0	0.24
2200.0	515D228M6R3DG6AE3	0.492 x 0.787 [12.5 x 20.0]	1050.0	0.24
3300.0	515D338M6R3DG6AE3	0.492 x 0.787 [12.5 x 20.0]	1250.0	0.24
4700.0	515D478M6R3EK6AE3	0.630 x 0.984 [16.0 x 25.0]	1700.0	0.24
6800.0	515D688M6R3EK6AE3	0.630 x 0.984 [16.0 x 25.0]	1900.0	0.24
10 000.0	515D109M6R3EN6AE3	0.630 x 1.240 [16.0 x 31.5]	2250.0	0.24
15 000.0	515D159M6R3FR6AE3	0.709 x 1.398 [18.0 x 35.5]	2680.0	0.24
18 000.0	515D189M6R3FV6AE3	0.709 x 1.575 [18.0 x 40.0]	2750.0	0.24
10 WV_{DC} AT +85 °C, SURGE = 13 V				
22.0	515D226M010JA6AE3	0.197 x 0.433 [5.0 x 11.0]	38.0	0.20
33.0	515D336M010JA6AE3	0.197 x 0.433 [5.0 x 11.0]	47.0	0.20
47.0	515D476M010JA6AE3	0.197 x 0.433 [5.0 x 11.0]	59.0	0.20
100.0	515D107M010JA6AE3	0.197 x 0.433 [5.0 x 11.0]	145.0	0.20
220.0	515D227M010AA6AE3	0.248 x 0.433 [6.3 x 11.0]	230.0	0.20
330.0	515D337M010BB6AE3	0.315 x 0.453 [8.0 x 11.5]	330.0	0.20
470.0	515D477M010BB6AE3	0.315 x 0.453 [8.0 x 11.5]	390.0	0.20
1000.0	515D108M010CD6AE3	0.394 x 0.630 [10.0 x 16.0]	630.0	0.20
2200.0	515D228M010DG6AE3	0.492 x 0.787 [12.5 x 20.0]	1100.0	0.20
3300.0	515D338M010DK6AE3	0.492 x 0.984 [12.5 x 25.0]	1400.0	0.20
4700.0	515D478M010EK6AE3	0.630 x 0.984 [16.0 x 25.0]	1800.0	0.20
6800.0	515D688M010EN6AE3	0.630 x 1.240 [16.0 x 31.5]	2150.0	0.20
10 000.0	515D109M010FR6AE3	0.709 x 1.398 [18.0 x 35.5]	2500.0	0.20
15 000.0	515D159M010FV6AE3	0.709 x 1.575 [18.0 x 40.0]	2720.0	0.20
16 WV_{DC} AT +85 °C, SURGE = 20 V				
10.0	515D106M016JA6AE3	0.197 x 0.433 [5.0 x 11.0]	28.0	0.16
22.0	515D226M016JA6AE3	0.197 x 0.433 [5.0 x 11.0]	44.0	0.16
33.0	515D336M016JA6AE3	0.197 x 0.433 [5.0 x 11.0]	57.0	0.16
47.0	515D476M016JA6AE3	0.197 x 0.433 [5.0 x 11.0]	168.0	0.16



ELECTRICAL DATA AND ORDERING INFORMATION				
CAPACITANCE (μF)	PART NUMBER	NOMINAL CASE SIZE D x L	MAX. RIPPLE AT +85 °C 120 Hz (mA)	MAX. DF AT +20 °C 120 Hz
16 WV_{DC} AT +85 °C, SURGE = 20 V				
100.0	515D107M016AA6AE3	0.248 x 0.433 [6.3 x 11.0]	175.0	0.16
220.0	515D227M016BB6AE3	0.315 x 0.453 [8.0 x 11.5]	300.0	0.16
330.0	515D337M016BB6AE3	0.315 x 0.453 [8.0 x 11.5]	360.0	0.16
470.0	515D477M016CC6AE3	0.394 x 0.492 [10.0 x 12.5]	470.0	0.16
1000.0	515D108M016CG6AE3	0.394 x 0.787 [10.0 x 20.0]	790.0	0.16
2200.0	515D228M016DK6AE3	0.492 x 0.984 [12.5 x 25.0]	1350.0	0.16
3300.0	515D338M016EK6AE3	0.630 x 0.984 [16.0 x 25.0]	1700.0	0.16
4700.0	515D478M016EN6AE3	0.630 x 1.240 [16.0 x 31.5]	2100.0	0.16
6800.0	515D688M016FR6AE3	0.709 x 1.398 [18.0 x 35.5]	2500.0	0.16
10 000.0	515D109M016FV6AE3	0.709 x 1.575 [18.0 x 40.0]	2640.0	0.16
25 WV_{DC} AT +85 °C, SURGE = 32 V				
4.7	515D475M025JA6AE3	0.197 x 0.433 [5.0 x 11.0]	30.0	0.14
10.0	515D106M025JA6AE3	0.197 x 0.433 [5.0 x 11.0]	33.0	0.14
22.0	515D226M025JA6AE3	0.197 x 0.433 [5.0 x 11.0]	51.0	0.14
33.0	515D336M025JA6AE3	0.197 x 0.433 [5.0 x 11.0]	63.0	0.14
47.0	515D476M025JA6AE3	0.197 x 0.433 [5.0 x 11.0]	115.0	0.14
100.0	515D107M025AA6AE3	0.248 x 0.433 [6.3 x 11.0]	185.0	0.14
220.0	515D227M025BB6AE3	0.315 x 0.453 [8.0 x 11.5]	320.0	0.14
330.0	515D337M025CC6AE3	0.394 x 0.492 [10.0 x 12.5]	420.0	0.14
470.0	515D477M025CD6AE3	0.394 x 0.630 [10.0 x 16.0]	540.0	0.14
1000.0	515D108M025DG6AE3	0.492 x 0.787 [12.5 x 20.0]	950.0	0.14
2200.0	515D228M025EK6AE3	0.630 x 0.984 [16.0 x 25.0]	1550.0	0.14
3300.0	515D338M025EN6AE3	0.630 x 1.240 [16.0 x 31.5]	1950.0	0.14
4700.0	515D478M025FR6AE3	0.709 x 1.398 [18.0 x 35.5]	2360.0	0.14
35 WV_{DC} AT +85 °C, SURGE = 44 V				
4.7	515D475M035JA6AE3	0.197 x 0.433 [5.0 x 11.0]	24.0	0.12
10.0	515D106M035JA6AE3	0.197 x 0.433 [5.0 x 11.0]	36.0	0.12
22.0	515D226M035JA6AE3	0.197 x 0.433 [5.0 x 11.0]	57.0	0.12
33.0	515D336M035JA6AE3	0.197 x 0.433 [5.0 x 11.0]	105.0	0.12
47.0	515D476M035AA6AE3	0.248 x 0.433 [6.3 x 11.0]	140.0	0.12
100.0	515D107M035BB6AE3	0.315 x 0.453 [8.0 x 11.5]	230.0	0.12
220.0	515D227M035CC6AE3	0.394 x 0.492 [10.0 x 12.5]	370.0	0.12
330.0	515D337M035CD6AE3	0.394 x 0.630 [10.0 x 16.0]	490.0	0.12
470.0	515D477M035CG6AE3	0.394 x 0.787 [10.0 x 20.0]	640.0	0.12
1000.0	515D108M035DK6AE3	0.492 x 0.984 [12.5 x 25.0]	1100.0	0.12
2200.0	515D228M035EN6AE3	0.630 x 1.240 [16.0 x 31.5]	1850.0	0.12
3300.0	515D338M035FR6AE3	0.709 x 1.382 [18.0 x 35.5]	2220.0	0.12
4700.0	515D478M035FV6AE3	0.709 x 1.575 [18.0 x 40.0]	2490.0	0.12
50 WV_{DC} AT +85 °C, SURGE = 63 V				
0.10	515D104M050JA6AE3	0.197 x 0.433 [5.0 x 11.0]	1.0	0.10
0.22	515D224M050JA6AE3	0.197 x 0.433 [5.0 x 11.0]	2.3	0.10
0.33	515D334M050JA6AE3	0.197 x 0.433 [5.0 x 11.0]	3.5	0.10
0.47	515D474M050JA6AE3	0.197 x 0.433 [5.0 x 11.0]	5.0	0.10
1.0	515D105M050JA6AE3	0.197 x 0.433 [5.0 x 11.0]	10.0	0.10
2.2	515D225M050JA6AE3	0.197 x 0.433 [5.0 x 11.0]	19.0	0.10
3.3	515D335M050JA6AE3	0.197 x 0.433 [5.0 x 11.0]	24.0	0.10
4.7	515D475M050JA6AE3	0.197 x 0.433 [5.0 x 11.0]	29.0	0.10
10.0	515D106M050JA6AE3	0.197 x 0.433 [5.0 x 11.0]	44.0	0.10
22.0	515D226M050JA6AE3	0.197 x 0.433 [5.0 x 11.0]	95.0	0.10
33.0	515D336M050AA6AE3	0.248 x 0.433 [6.3 x 11.0]	125.0	0.10
47.0	515D476M050AA6AE3	0.248 x 0.433 [6.3 x 11.0]	150.0	0.10
100.0	515D107M050BB6AE3	0.315 x 0.453 [8.0 x 11.5]	250.0	0.10
220.0	515D227M050CD6AE3	0.394 x 0.630 [10.0 x 16.0]	440.0	0.10
330.0	515D337M050CG6AE3	0.394 x 0.787 [10.0 x 20.0]	580.0	0.10
470.0	515D477M050DG6AE3	0.492 x 0.787 [12.5 x 20.0]	760.0	0.10
1000.0	515D108M050EK6AE3	0.630 x 0.984 [16.0 x 25.0]	1350.0	0.10
2200.0	515D228M050FR6AE3	0.709 x 1.398 [18.0 x 35.5]	2090.0	0.10



ELECTRICAL DATA AND ORDERING INFORMATION				
CAPACITANCE (μF)	PART NUMBER	NOMINAL CASE SIZE D x L	MAX. RIPPLE AT +85 °C 120 Hz (mA)	MAX. DF AT +20 °C 120 Hz
63 WV_{DC} AT +85 °C, SURGE = 79 V				
4.7	515D475M063JA6AE3	0.197 x 0.433 [5.0 x 11.0]	45.0	0.08
10.0	515D106M063JA6AE3	0.197 x 0.433 [5.0 x 11.0]	70.0	0.08
22.0	515D226M063AA6AE3	0.248 x 0.433 [6.3 x 11.0]	115.0	0.08
33.0	515D336M063AA6AE3	0.248 x 0.433 [6.3 x 11.0]	140.0	0.08
47.0	515D476M063BB6AE3	0.315 x 0.453 [8.0 x 11.5]	190.0	0.08
100.0	515D107M063CC6AE3	0.394 x 0.492 [10.0 x 12.5]	300.0	0.08
220.0	515D227M063CG6AE3	0.394 x 0.787 [10.0 x 20.0]	490.0	0.08
330.0	515D337M063DG6AE3	0.492 x 0.787 [12.5 x 20.0]	680.0	0.08
470.0	515D477M063DK6AE3	0.492 x 0.984 [12.5 x 25.0]	880.0	0.08
1000.0	515D108M063EN6AE3	0.630 x 1.240 [16.0 x 31.5]	1550.0	0.08
2200.0	515D228M063FV6AE3	0.709 x 1.575 [18.0 x 40.0]	2200.0	0.08
100 WV_{DC} AT +85 °C, SURGE = 125 V				
0.10	515D104M100JA6AE3	0.197 x 0.433 [5.0 x 11.0]	2.1	0.08
0.22	515D224M100JA6AE3	0.197 x 0.433 [5.0 x 11.0]	4.7	0.08
0.33	515D334M100JA6AE3	0.197 x 0.433 [5.0 x 11.0]	7.0	0.08
0.47	515D474M100JA6AE3	0.197 x .0433 [5.0 x 11.0]	10.0	0.08
1.0	515D105M100JA6AE3	0.197 x 0.433 [5.0 x 11.0]	21.0	0.08
2.2	515D225M100JA6AE3	0.197 x 0.433 [5.0 x 11.0]	30.0	0.08
3.3	515D335M100JA6AE3	0.197 x 0.433 [5.0 x 11.0]	40.0	0.08
4.7	515D475M100JA6AE3	0.197 x 0.433 [5.0 x 11.0]	45.0	0.08
10.0	515D106M100AA6AE3	0.248 x 0.433 [6.3 x 11.0]	75.0	0.08
22.0	515D226M100BB6AE3	0.315 x 0.453 [8.0 x 11.5]	130.0	0.08
33.0	515D336M100CC6AE3	0.394 x 0.492 [10.0 x 12.5]	170.0	0.08
47.0	515D476M100CD6AE3	0.394 x 0.630 [10.0 x 16.0]	230.0	0.08
100.0	515D107M100DG6AE3	0.492 x 0.787 [12.5 x 20.0]	400.0	0.08
220.0	515D227M100EK6AE3	0.630 x 0.984 [16.0 x 25.0]	710.0	0.08
330.0	515D337M100EK6AE3	0.630 x 0.984 [16.0 x 25.0]	860.0	0.08
470.0	515D477M100EN6AE3	0.630 x 1.240 [16.0 x 31.5]	1100.0	0.08
1000.0	515D108M100FV6AE3	0.709 x 1.575 [18.0 x 40.0]	1690.0	0.08
160 WV_{DC} AT +85 °C, SURGE = 200 V				
0.47	515D474M160AA6AE3	0.248 x 0.433 [6.3 x 11.0]	12.0	0.20
1.0	515D105M160AA6AE3	0.248 x 0.433 [6.3 x 11.0]	17.0	0.20
2.2	515D225M160AA6AE3	0.248 x 0.433 [6.3 x 11.0]	26.0	0.20
3.3	515D335M160BB6AE3	0.315 x 0.453 [8.0 x 11.5]	35.0	0.20
4.7	515D475M160BB6AE3	0.315 x 0.453 [8.0 x 11.5]	40.0	0.20
10.0	515D106M160CC6AE3	0.394 x 0.492 [10.0 x 12.5]	65.0	0.20
22.0	515D226M160CG6AE3	0.394 x 0.787 [10.0 x 20.0]	110.0	0.20
33.0	515D336M160DG6AE3	0.492 x 0.787 [12.5 x 20.0]	150.0	0.20
47.0	515D476M160DK6AE3	0.492 x 0.984 [12.5 x 25.0]	180.0	0.20
100.0	515D107M160EK6AE3	0.630 x 0.984 [16.0 x 25.0]	300.0	0.20
220.0	515D227M160FR6AE3	0.709 x 1.398 [18.0 x 35.5]	510.0	0.20
200 WV_{DC} AT +85 °C, SURGE = 250 V				
0.47	515D474M200AA6AE3	0.248 x 0.433 [6.3 x 11.0]	12.0	0.20
1.0	515D105M200AA6AE3	0.248 x 0.433 [6.3 x 11.0]	17.0	0.20
2.2	515D225M200AA6AE3	0.248 x 0.433 [6.3 x 11.0]	26.0	0.20
3.3	515D335M200BB6AE3	0.315 x 0.453 [8.0 x 11.5]	35.0	0.20
4.7	515D475M200CC6AE3	0.394 x 0.492 [10.0 x 12.5]	45.0	0.20
10.0	515D106M200CD6AE3	0.394 x 0.630 [10.0 x 16.0]	70.0	0.20
22.0	515D226M200CG6AE3	0.394 x 0.787 [10.0 x 20.0]	110.0	0.20
33.0	515D336M200DK6AE3	0.492 x 0.984 [12.5 x 25.0]	160.0	0.20
47.0	515D476M200DK6AE3	0.492 x 0.984 [12.5 x 25.0]	180.0	0.20
100.0	515D107M200EN6AE3	0.630 x 1.240 [16.0 x 31.5]	330.0	0.20
220.0	515D227M200FV6AE3	0.709 x 1.575 [18.0 x 40.0]	520.0	0.20



ELECTRICAL DATA AND ORDERING INFORMATION				
CAPACITANCE (μF)	PART NUMBER	NOMINAL CASE SIZE D x L	MAX. RIPPLE AT +85 °C 120 Hz (mA)	MAX. DF AT +20 °C 120 Hz
250 WV_{DC} AT +85 °C, SURGE = 300 V				
0.47	515D474M250AA6AE3	0.248 x 0.433 [6.3 x 11.0]	12.0	0.20
1.0	515D105M250AA6AE3	0.248 x 0.433 [6.3 x 11.0]	17.0	0.20
2.2	515D225M250BB6AE3	0.315 x 0.453 [8.0 x 11.5]	30.0	0.20
3.3	515D335M250CC6AE3	0.394 x 0.492 [10.0 x 12.5]	35.0	0.20
4.7	515D475M250CC6AE3	0.394 x 0.492 [10.0 x 12.5]	45.0	0.20
10.0	515D106M250CG6AE3	0.394 x 0.787 [10.0 x 20.0]	70.0	0.20
33.0	515D336M250DK6AE3	0.492 x 0.984 [12.5 x 25.0]	160.0	0.20
47.0	515D476M250EK6AE3	0.630 x 1.240 [16.0 x 31.5]	210.0	0.20
100.0	515D107M250FR6AE3	0.709 x 1.575 [18.0 x 40.0]	340.0	0.20
315 WV_{DC} AT +85 °C, SURGE = 365 V				
1.0	515D105M315AA6AE3	0.248 x 0.433 [6.3 x 11.0]	17.0	0.20
2.2	515D225M315BB6AE3	0.315 x 0.453 [8.0 x 11.5]	30.0	0.20
3.3	515D335M315CC6AE3	0.394 x 0.492 [10.0 x 12.5]	35.0	0.20
4.7	515D475M315CD6AE3	0.394 x 0.630 [10.0 x 16.0]	45.0	0.20
10.0	515D106M315CG6AE3	0.394 x 0.787 [10.0 x 20.0]	70.0	0.20
22.0	515D226M315DK6AE3	0.492 x 0.984 [12.5 x 25.0]	120.0	0.20
33.0	515D336M315EK6AE3	0.630 x 0.984 [16.0 x 25.0]	150.0	0.20
47.0	515D476M315EN6AE3	0.630 x 1.240 [16.0 x 31.5]	190.0	0.20
100.0	515D107M315FV6AE3	0.709 x 1.575 [18.0 x 40.0]	340.0	0.20
350 WV_{DC} AT +85 °C, SURGE = 400 V				
1.0	515D105M350BB6AE3	0.315 x 0.453 [8.0 x 11.5]	18.0	0.25
2.2	515D225M350CC6AE3	0.394 x 0.492 [10.0 x 12.5]	28.0	0.25
3.3	515D335M350CD6AE3	0.394 x 0.630 [10.0 x 16.0]	35.0	0.25
4.7	515D475M350CD6AE3	0.394 x 0.630 [10.0 x 16.0]	40.0	0.25
10.0	515D106M350DG6AE3	0.492 x 0.787 [12.5 x 20.0]	70.0	0.25
22.0	515D226M350DK6AE3	0.492 x 0.984 [12.5 x 25.0]	110.0	0.25
33.0	515D336M350EN6AE3	0.630 x 1.240 [16.0 x 31.5]	140.0	0.25
47.0	515D476M350FR6AE3	0.709 x 1.398 [18.0 x 35.5]	220.0	0.25
400 WV_{DC} AT +85 °C, SURGE = 450 V				
1.0	515D105M400BB6AE3	0.315 x 0.453 [8.0 x 11.5]	18.0	0.25
2.2	515D225M400CC6AE3	0.394 x 0.492 [10.0 x 12.5]	28.0	0.25
3.3	515D335M400CD6AE3	0.394 x 0.630 [10.0 x 16.0]	35.0	0.25
4.7	515D475M400CD6AE3	0.394 x 0.787 [10.0 x 20.0]	45.0	0.25
10.0	515D106M400DG6AE3	0.492 x 0.787 [12.5 x 20.0]	70.0	0.25
22.0	515D226M400DK6AE3	0.630 x 0.984 [16.0 x 25.0]	110.0	0.25
33.0	515D336M400EN6AE3	0.630 x 1.240 [16.0 x 31.5]	140.0	0.25
47.0	515D476M400FR6AE3	0.709 x 1.398 [18.0 x 35.5]	220.0	0.25
450 WV_{DC} AT +85 °C, SURGE = 500 V				
1.0	515D105M450CC6AE3	0.394 x 0.492 [10.0 x 12.5]	19.0	0.25
2.2	515D225M450CD6AE3	0.394 x 0.630 [10.0 x 16.0]	29.0	0.25
4.7	515D475M450DG6AE3	0.492 x 0.787 [12.5 x 20.0]	50.0	0.25
10.0	515D106M450EK6AE3	0.492 x 0.984 [12.5 x 25.0]	75.0	0.25
22.0	515D226M450EN6AE3	0.630 x 1.240 [16.0 x 31.5]	110.0	0.25
33.0	515D336M450FR6AE3	0.709 x 1.398 [18.0 x 35.5]	170.0	0.25

Statements about product lifetime are based on calculations and internal testing. They should only be interpreted as estimations. Also due to external factors, the lifetime in the field application may deviate from the calculated lifetime. In general, nothing stated herein shall be construed as a guarantee of durability.



Disclaimer

ALL PRODUCT, PRODUCT SPECIFICATIONS AND DATA ARE SUBJECT TO CHANGE WITHOUT NOTICE TO IMPROVE RELIABILITY, FUNCTION OR DESIGN OR OTHERWISE.

Vishay Intertechnology, Inc., its affiliates, agents, and employees, and all persons acting on its or their behalf (collectively, "Vishay"), disclaim any and all liability for any errors, inaccuracies or incompleteness contained in any datasheet or in any other disclosure relating to any product.

Vishay makes no warranty, representation or guarantee regarding the suitability of the products for any particular purpose or the continuing production of any product. To the maximum extent permitted by applicable law, Vishay disclaims (i) any and all liability arising out of the application or use of any product, (ii) any and all liability, including without limitation special, consequential or incidental damages, and (iii) any and all implied warranties, including warranties of fitness for particular purpose, non-infringement and merchantability.

Statements regarding the suitability of products for certain types of applications are based on Vishay's knowledge of typical requirements that are often placed on Vishay products in generic applications. Such statements are not binding statements about the suitability of products for a particular application. It is the customer's responsibility to validate that a particular product with the properties described in the product specification is suitable for use in a particular application. Parameters provided in datasheets and / or specifications may vary in different applications and performance may vary over time. All operating parameters, including typical parameters, must be validated for each customer application by the customer's technical experts. Product specifications do not expand or otherwise modify Vishay's terms and conditions of purchase, including but not limited to the warranty expressed therein.

Hyperlinks included in this datasheet may direct users to third-party websites. These links are provided as a convenience and for informational purposes only. Inclusion of these hyperlinks does not constitute an endorsement or an approval by Vishay of any of the products, services or opinions of the corporation, organization or individual associated with the third-party website. Vishay disclaims any and all liability and bears no responsibility for the accuracy, legality or content of the third-party website or for that of subsequent links.

Except as expressly indicated in writing, Vishay products are not designed for use in medical, life-saving, or life-sustaining applications or for any other application in which the failure of the Vishay product could result in personal injury or death. Customers using or selling Vishay products not expressly indicated for use in such applications do so at their own risk. Please contact authorized Vishay personnel to obtain written terms and conditions regarding products designed for such applications.

No license, express or implied, by estoppel or otherwise, to any intellectual property rights is granted by this document or by any conduct of Vishay. Product names and markings noted herein may be trademarks of their respective owners.

Mouser Electronics

Authorized Distributor

Click to View Pricing, Inventory, Delivery & Lifecycle Information:

Vishay:

[515D105M050JA6AE3](#) [515D106M025JA6AE3](#) [515D106M035JA6AE3](#) [515D106M050JA6AE3](#)
[515D106M063JA6AE3](#) [515D107M010JA6AE3](#) [515D107M025AA6AE3](#) [515D107M035BB6AE3](#)
[515D107M050BB6AE3](#) [515D107M063CC6AE3](#) [515D108M010CD6AE3](#) [515D108M035DK6AE3](#)
[515D108M050EK6AE3](#) [515D225M100JA6AE3](#) [515D226M025JA6AE3](#) [515D226M050JA6AE3](#) [515D226M100BB6AE3](#)
[515D227M016BB6AE3](#) [515D227M025BB6AE3](#) [515D227M035CC6AE3](#) [515D227M050CD6AE3](#)
[515D227M063CG6AE3](#) [515D228M016DK6AE3](#) [515D228M035EN6AE3](#) [515D335M050JA6AE3](#)
[515D336M035JA6AE3](#) [515D337M025CC6AE3](#) [515D337M035CD6AE3](#) [515D475M025JA6AE3](#)
[515D475M063JA6AE3](#) [515D476M025JA6AE3](#) [515D476M035AA6AE3](#) [515D476M050AA6AE3](#)
[515D476M063BB6AE3](#) [515D476M100CD6AE3](#) [515D476M160DK6AE3](#) [515D477M016CC6AE3](#)
[515D477M035CG6AE3](#) [515D475M050JA6AE3](#) [515D107M016AA6AE3](#) [515D477M050DG6AE3](#)
[515D337M050CG6AE3](#) [515D108M016CG6AE3](#) [515D337M016BB6AE3](#) [515D226M016JA6AE3](#)
[515D337M010BB6AE3](#) [515D478M035FV6AE3](#) [515D474M100JA6AE3](#) [515D336M016JA6AE3](#)
[515D106M250CG6AE3](#) [515D477M063DK6AE3](#) [515D336M025JA6AE3](#) [515D477M010BB6AE3](#)
[515D338M010DK6AE3](#) [515D336M450FR6AE3](#) [515D338M025EN6AE3](#) [515D225M050JA6AE3](#)
[515D106M100AA6AE3](#) [515D108M025DG6AE3](#) [515D476M010JA6AE3](#) [515D476M016JA6AE3](#)
[515D475M450DG6AE3](#) [515D226M035JA6AE3](#) [515D477M025CD6AE3](#) [515D228M010DG6AE3](#)
[515D105M100JA6AE3](#) [515D105M450CC6AE3](#) [515D226M450EN6AE3](#) [515D225M160AA6AE3](#)
[515D226M350DK6AE3](#) [515D338M016EK6AE3](#) [515D106M160CC6AE3](#) [515D228M025EK6AE3](#)
[515D108M063EN6AE3](#) [515D336M350EN6AE3](#) [515D227M010AA6AE3](#) [515D474M050JA6AE3](#)
[515D336M050AA6AE3](#) [515D228M050FR6AE3](#) [515D107M100DG6AE3](#)