

PCB terminal block - PT 1,5/ 6-5,0-H - 1935200

Please be informed that the data shown in this PDF Document is generated from our Online Catalog. Please find the complete data in the user's documentation. Our General Terms of Use for Downloads are valid (<http://phoenixcontact.com/download>)

PCB terminal block, nominal current: 17.5 A, rated voltage (III/2): 400 V, nominal cross section: 1.5 mm², pitch: 5 mm, number of positions: 6, connection method: Screw connection with wire protector, mounting: Wave soldering, conductor/PCB connection direction: 0 °, color: green, Pin layout: Linear pinning, Solder pin [P]: 3.5 mm



The figure shows a 10-position version of the product

Your advantages

- Well-known connection principle allows worldwide use
- Low temperature rise, thanks to maximum contact force
- High terminal block capacity thanks to rectangular terminal block space
- Allows connection of two conductors
- The latching on the side enables various numbers of positions to be combined



Key Commercial Data

Packing unit	100 pc
GTIN	
GTIN	4017918916978

Technical data

Item properties

Brief article description	PCB terminal block
Range of articles	PT 1,5/..-H
Pitch	5 mm
Number of positions	6
Connection method	Screw connection with wire protector
Screw thread	M2,6
Mounting type	Wave soldering
Pin layout	Linear pinning
Number of levels	1
Number of connections	6

PCB terminal block - PT 1,5/ 6-5,0-H - 1935200

Technical data

Item properties

Number of potentials	6
----------------------	---

Electrical parameters

Nominal current	17.5 A
Nom. voltage	400 V
Rated voltage	250 V
Rated voltage (III/2)	400 V
Rated voltage (II/2)	630 V
Rated surge voltage (III/3)	4 kV
Rated surge voltage (III/2)	4 kV
Rated surge voltage (II/2)	4 kV

Connection capacity

Connection method	Screw connection with wire protector
pluggable	no
Conductor cross section solid	0.2 mm ² ... 2.5 mm ²
Conductor cross section flexible	0.2 mm ² ... 2.5 mm ²
Conductor cross section AWG / kcmil	26 ... 14
Conductor cross section flexible, with ferrule without plastic sleeve	0.25 mm ² ... 1.5 mm ²
Conductor cross section, flexible, with ferrule, with plastic sleeve	0.25 mm ² ... 1.5 mm ²
2 conductors with same cross section, solid	0.2 mm ² ... 0.75 mm ²
2 conductors with same cross section, flexible	0.2 mm ² ... 0.75 mm ²
2 conductors with same cross section, flexible, with ferrule without plastic sleeve	0.25 mm ² ... 0.34 mm ²
2 conductors with the same cross section, flexible, with TWIN ferrule with plastic sleeve	0.5 mm ² ... 0.75 mm ²
Stripping length	5 mm
Torque	0.35 Nm ... 0.4 Nm

Material data - contact

Note	WEEE/RoHS-compliant, free of whiskers according to IEC 60068-2-82/ JEDEC JESD 201
Contact material	Cu alloy
Surface characteristics	Tin-plated
Metal surface terminal point (top layer)	Tin (3 - 12 µm Sn)
Metal surface terminal point (middle layer)	Nickel (1.5 - 4 µm Ni)
Metal surface soldering area (top layer)	Tin (3 - 12 µm Sn)
Metal surface soldering area (middle layer)	Nickel (1.5 - 4 µm Ni)

Material data - housing

Housing color	green (6021)
Insulating material	PA
Insulating material group	I
CTI according to IEC 60112	600

PCB terminal block - PT 1,5/ 6-5,0-H - 1935200

Technical data

Material data - housing

Flammability rating according to UL 94	V0
Glow wire flammability index GWFI according to EN 60695-2-12	850
Glow wire ignition temperature GWIT according to EN 60695-2-13	775
Temperature for the ball pressure test according to EN 60695-10-2	125 °C

Dimensions for the product

Length [l]	9 mm
Width [w]	30 mm
Height [h]	14.9 mm
Pitch	5 mm
Height (without solder pin)	11.4 mm
Solder pin [P]	3.5 mm
Pin spacing	5 mm
Pin dimensions	ø 1 mm

Dimensions for PCB design

Hole diameter	1.3 mm
Pin spacing	5 mm

Packaging information

Type of packaging	packed in cardboard
Pieces per package	100
Denomination packing units	Pcs.

General product information

Type of note	Note on application
	Note on application
Note	For safe conductor connection, always adhere to a defined tightening torque. Particularly in the case of PCB terminal blocks with two or three positions, the individual solder pin for each contact point cannot compensate for this. That is why the terminal blocks must be supported during conductor connection (held with one hand, support on the housing).
	When using ferrules and taking the specified stripping length into consideration, 250 V is only achieved in conjunction with overvoltage category/pollution degree II/2.

Ambient conditions

Ambient temperature (storage/transport)	-40 °C ... 70 °C
Ambient temperature (assembly)	-5 °C ... 100 °C
Ambient temperature (operation)	-40 °C ... 100 °C (dependent on the derating curve)

Termination and connection method

Test for conductor damage and slackening	IEC 60999-1:1999-11
	Test passed

Pull-out test

PCB terminal block - PT 1,5/ 6-5,0-H - 1935200

Technical data

Pull-out test

Pull-out test	IEC 60999-1:1999-11
	Test passed
Conductor cross section / conductor type / tensile force	0.2 mm ² / flexible / > 10 N
	0.2 mm ² / solid / > 10 N
	2.5 mm ² / flexible / > 50 N
	2.5 mm ² / solid / > 50 N

Mechanical tests according to standard

Test specification	IEC 60947-7-4
--------------------	---------------

Electrical tests

Rated current	17.5 A
Conductor cross section	2.5 mm ²
Rated voltage (III/2)	400 V
Rated surge voltage (III/2)	4 kV

Temperature-rise test

Specification	IEC 60947-7-4:2013-08
Result	Test passed
Requirement temperature-rise test	The sum of ambient temperature and temperature rise of the PCB terminal block shall not exceed the upper limiting temperature.

Current carrying capacity / derating curves

Caption	Type: PT 1,5/...-5,0-H (S)
Specification	IEC 60947-7-4:2013-08
Number of positions	4
Reduction factor	1
Note	Representation based on IEC 60512-5-2:2002-02

Vibration test

Specification	IEC 60068-2-6:2007-12
Result	Test passed
Frequency	10 - 150 - 10 Hz
Sweep speed	1 octave/min
Amplitude	0.35 mm (10 - 60.1 Hz)
Acceleration	5 g (60.1 - 150 Hz)
Test duration per axis	2.5 h

Insulation resistance

Specification	IEC 60512-3-1:2002-02
Result	Test passed
Insulation resistance, neighboring positions	> 0.1 TΩ

Glow-wire test

Specification	IEC 60695-2-10:2000-10
---------------	------------------------

PCB terminal block - PT 1,5/ 6-5,0-H - 1935200

Technical data

Glow-wire test

Result	Test passed
Temperature	850 °C
Time of exposure	5 s

Alternating climate test

Result	Test passed
Specification	ISO 6988:1985-02
Corrosive stress	KFW 0.2 S/1 cycle

Standards and Regulations

Connection in acc. with standard	EN-VDE
	CUL
Flammability rating according to UL 94	V0

Environmental Product Compliance

REACH SVHC	Lead 7439-92-1
China RoHS	Environmentally Friendly Use Period = 50 years
	For details about hazardous substances go to tab "Downloads", Category "Manufacturer's declaration"

Drawings

PCB terminal block - PT 1,5/ 6-5,0-H - 1935200

Drilling diagram

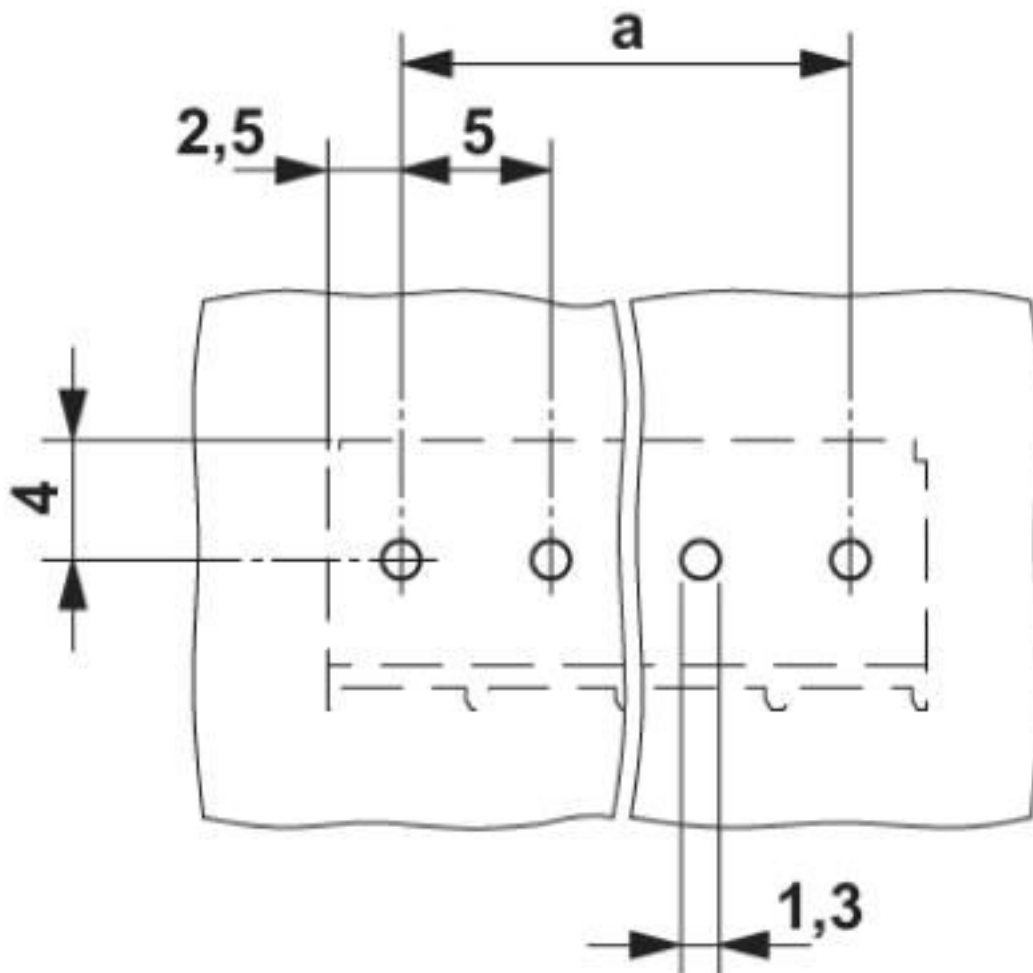

PCB terminal block - PT 1,5/ 6-5,0-H - 1935200

Diagram

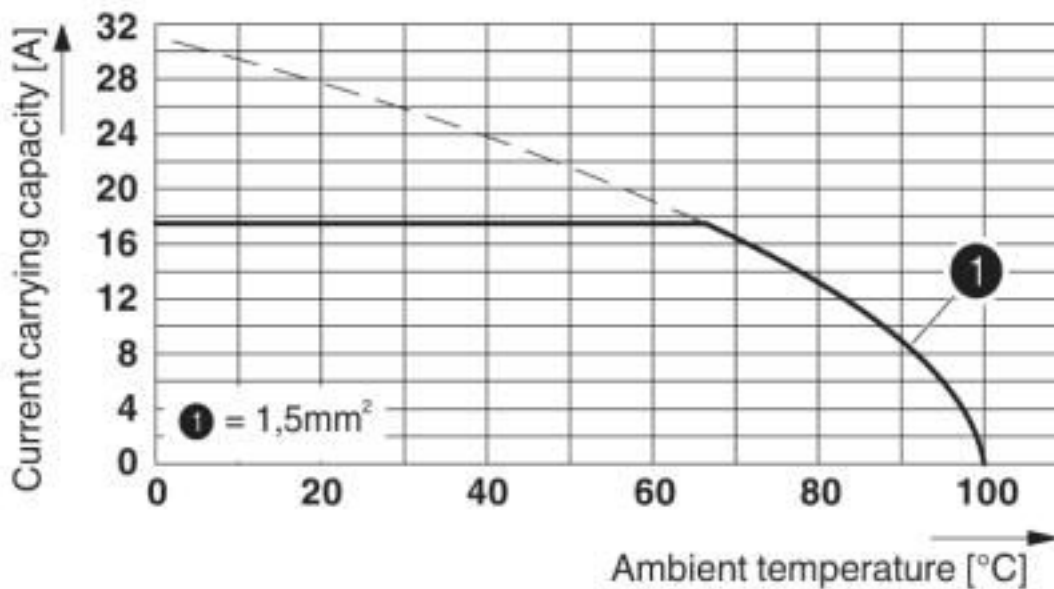

Derating diagram for 5 pins;reduction factor=1

Dimensional drawing

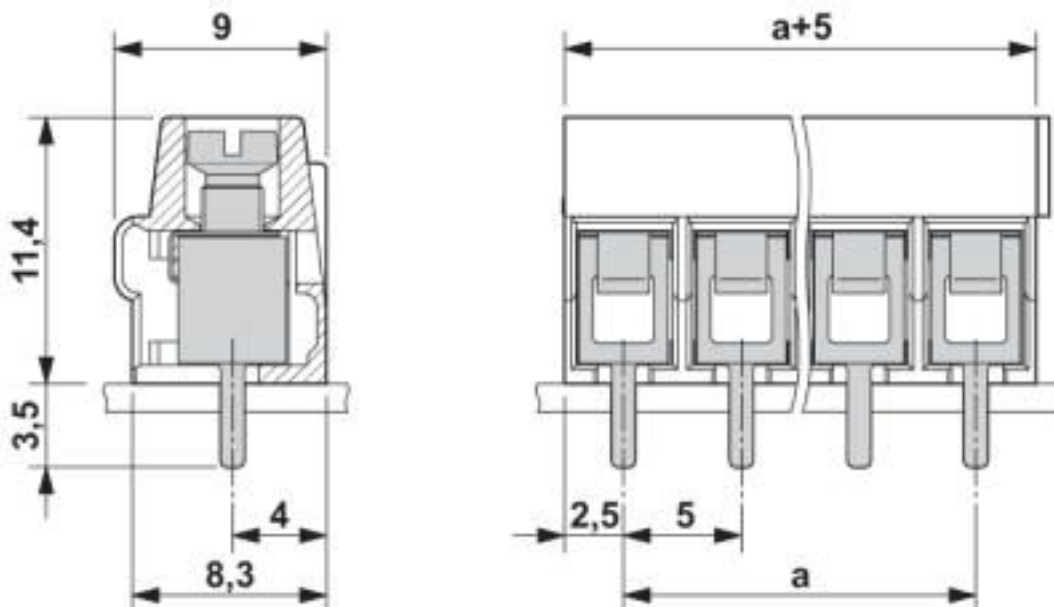

Classifications

eCl@ss

eCl@ss 10.0.1	27440401
eCl@ss 4.0	27260700
eCl@ss 4.1	27141100

PCB terminal block - PT 1,5/ 6-5,0-H - 1935200

Classifications

eCl@ss

eCl@ss 5.0	27141100
eCl@ss 5.1	27261100
eCl@ss 6.0	27261100
eCl@ss 7.0	27440401
eCl@ss 8.0	27440401
eCl@ss 9.0	27440401

ETIM

ETIM 3.0	EC001121
ETIM 4.0	EC002643
ETIM 5.0	EC002643
ETIM 6.0	EC002643
ETIM 7.0	EC002643

UNSPSC

UNSPSC 6.01	30211801
UNSPSC 7.0901	39121432
UNSPSC 11	34131203
UNSPSC 12.01	39121432
UNSPSC 13.2	39121432
UNSPSC 18.0	39121432
UNSPSC 19.0	39121432
UNSPSC 20.0	39121432
UNSPSC 21.0	39121432

Approvals

Approvals

Approvals

SEV / VDE Gutachten mit Fertigungsüberwachung / EAC / cULus Recognized / IECEE CB Scheme

Ex Approvals

Approval details

PCB terminal block - PT 1,5/ 6-5,0-H - 1935200

Approvals

SEV		https://www.eurofins.ch/de/	IK-4496
Nominal voltage UN		250 V	
Nominal current IN		17.5 A	
mm ² /AWG/kcmil		0.2-1.5	

VDE Gutachten mit Fertigungsüberwachung		http://www2.vde.com/de/Institut/Online-Service/VDE-gepruefteProdukte/Seiten/Online-Suche.aspx	40031691
Nominal voltage UN		250 V	
Nominal current IN		24 A	
mm ² /AWG/kcmil		0.2-2.5	

EAC			B.01687
-----	--	--	---------

cULus Recognized		http://database.ul.com/cgi-bin/XYV/template/LISEXT/1FRAME/index.htm	E60425-20030211
	B	D	
Nominal voltage UN	300 V	300 V	
Nominal current IN	18 A	10 A	
mm ² /AWG/kcmil	26-12	26-12	

IECEE CB Scheme		http://www.iecee.org/	CH-10786
Nominal voltage UN		250 V	
Nominal current IN		17.5 A	
mm ² /AWG/kcmil		0.2-1.5	

Accessories

Accessories

Crimping tool

PCB terminal block - PT 1,5/ 6-5,0-H - 1935200

Accessories

Crimping pliers - CRIMPFOX CENTRUS 6S - 1213144



Crimping pliers, for uninsulated and insulated ferrules, DIN 46228 Part 1 and 4, from 0.14 mm² ... 6 mm², also for TWIN ferrules up to 2 x 4 mm², automatic cross section adjustment, lateral insertion, equipped with fall protection

Crimping pliers - CRIMPFOX 6 - 1212034



Crimping pliers, for ferrules without insulating collar according to DIN 46228 Part 1 and ferrules with insulating collar according to DIN 46228 Part 4, 0.25 mm² ... 6.0 mm², lateral entry, trapezoidal crimp

Labeled terminal marker

Marker card - SK 5/3,8:FORTL.ZAHLEN - 0804183



Marker card, Card, white, labeled, horizontal: consecutive numbers 1 ... 10, 11 ... 20, etc. up to 91 ... (99)100, mounting type: adhesive, for terminal block width: 5 mm, lettering field size: 5 x 3.8 mm

Screwdriver tools

Screwdriver - SZS 0,6X3,5 - 1205053



Actuation tool, for ST terminal blocks, insulated, also suitable for use as a bladed screwdriver, size: 0.6 x 3.5 x 100 mm, 2-component grip, with non-slip grip

Mouser Electronics

Authorized Distributor

Click to View Pricing, Inventory, Delivery & Lifecycle Information:

[Phoenix Contact:](#)

[1935200](#)