

User Manual

MR Series High Voltage Multi-Range DC Power Supplies



Safety Summary

The following safety precautions apply to both operating and maintenance personnel and must be followed during all phases of operation, service, and repair of this instrument.

WARNING

Before applying power to this instrument:

- Read and understand the safety and operational information in this manual.
- Apply all the listed safety precautions.
- Verify that the voltage selector at the line power cord input is set to the correct line voltage. Operating the instrument at an incorrect line voltage will void the warranty.
- Make all connections to the instrument before applying power.
- Do not operate the instrument in ways not specified by this manual or by B&K Precision.

Failure to comply with these precautions or with warnings elsewhere in this manual violates the safety standards of design, manufacture, and intended use of the instrument. B&K Precision assumes no liability for a customer's failure to comply with these requirements.

Category rating

The IEC 61010 standard defines safety category ratings that specify the amount of electrical energy available and the voltage impulses that may occur on electrical conductors associated with these category ratings.

The category rating is a Roman numeral of I, II, III, or IV. This rating is also accompanied by a maximum voltage of the circuit to be tested, which defines the voltage impulses expected and required insulation clearances. These categories are:

Category I (CAT I): Measurement instruments whose measurement inputs are not intended to be connected to the mains supply. The voltages in the environment are typically derived from a limited-energy transformer or a battery.

Category II (CAT II): Measurement instruments whose measurement inputs are meant to be connected to the mains supply at a standard wall outlet or similar sources. Example measurement environments are portable tools and household appliances.

Category III (CAT III): Measurement instruments whose measurement inputs are meant to be connected to the mains installation of a building. Examples are measurements inside a building's circuit breaker panel or the wiring of permanently-installed motors.

Category IV (CAT IV): Measurement instruments whose measurement inputs are meant to be connected to the primary power entering a building or other outdoor wiring.

 **WARNING**

Do not use this instrument in an electrical environment with a higher category rating than what is specified in this manual for this instrument.

 **WARNING**

You must ensure that each accessory you use with this instrument has a category rating equal to or higher than the instrument's category rating to maintain the instrument's category rating. Failure to do so will lower the category rating of the measuring system.

Electrical Power

This instrument is intended to be powered from a CATEGORY II mains power environment. The mains power should be 120 V RMS or 240 V RMS. Use only the power cord supplied with the instrument and ensure it is appropriate for your country of use.

Ground the Instrument

WARNING

To minimize shock hazard, the instrument chassis and cabinet must be connected to an electrical safety ground. This instrument is grounded through the ground conductor of the supplied, three-conductor AC line power cable. The power cable must be plugged into an approved three-conductor electrical outlet. The power jack and mating plug of the power cable meet IEC safety standards.

WARNING

Do not alter or defeat the ground connection. Without the safety ground connection, all accessible conductive parts (including control knobs) may provide an electric shock. Failure to use a properly-grounded approved outlet and the recommended three-conductor AC line power cable may result in injury or death.

WARNING

Unless otherwise stated, a ground connection on the instrument's front or rear panel is for a reference of potential only and is not to be used as a safety ground.

Do not operate in an explosive or flammable atmosphere

WARNING

Do not operate the instrument in the presence of flammable gases or vapors, fumes, or finely-divided particulates.

WARNING

The instrument is designed to be used in office-type indoor environments. Do not operate the instrument

In the presence of noxious, corrosive, or flammable fumes, gases, vapors, chemicals, or finely-divided particulates.

In relative humidity conditions outside the instrument's specifications.

In environments where there is a danger of any liquid being spilled on the instrument or where any liquid can condense on the instrument.

In air temperatures exceeding the specified operating temperatures.

In atmospheric pressures outside the specified altitude limits or where the surrounding gas is not air.

In environments with restricted cooling air flow, even if the air temperatures are within specifications.

In direct sunlight.

CAUTION

This instrument is intended to be used in an indoor pollution degree 2 environment. The operating temperature range is 0 °C to 40 °C and the operating humidity 90% relative humidity with no condensation allowed.

Measurements made by this instrument may be outside specifications if the instrument is used in non-office-type environments. Such environments may include rapid temperature or humidity changes, sunlight, vibration and/or mechanical shocks, acoustic noise, electrical noise, strong electric fields, or strong magnetic fields.

Do not operate instrument if damaged

WARNING

If the instrument is damaged, appears to be damaged, or if any liquid, chemical, or other material gets on or inside the instrument, remove the instrument's power cord, remove the instrument from service, label it as not to be operated, and return the instrument to B&K Precision for repair. Notify B&K Precision of the nature of any contamination of the instrument.

Clean the instrument only as instructed

WARNING

Do not clean the instrument, its switches, or its terminals with contact cleaners, abrasives, lubricants, solvents, acids/bases, or other such chemicals. Clean the instrument only with a clean dry lint-free cloth or as instructed in this manual.

Not for critical applications

WARNING

This instrument is not authorized for use in contact with the human body or for use as a component in a life-support device or system.

Do not touch live circuits

WARNING

Instrument covers must not be removed by operating personnel. Component replacement and internal adjustments must be made by qualified service-trained maintenance personnel who are aware of the hazards involved when the instrument's covers and shields are removed. Under certain conditions, even with the power cord removed, dangerous voltages may exist when the covers are removed. To avoid injuries, always disconnect the power cord from the instrument, disconnect all other connections (for example, test leads, computer interface cables, etc.), discharge all circuits, and verify there are no hazardous voltages present on any conductors by measurements with a properly-operating voltage-sensing device before touching any internal parts. Verify the voltage-sensing device is working properly before and after making the measurements by testing with known-operating voltage sources and test for both DC and AC voltages. Do not attempt any service or adjustment unless another person capable of rendering first aid and resuscitation is present.

Do not insert any object into an instrument's ventilation openings or other openings.

WARNING

Hazardous voltages may be present in unexpected locations in circuitry being tested when a fault condition in the circuit exists.

Fuse replacement

WARNING

Fuse replacement must be done by qualified service-trained maintenance personnel who are aware of the instrument's fuse requirements and safe replacement procedures. Disconnect the instrument from the power line before replacing fuses. Replace fuses only with new fuses of the fuse types, voltage ratings, and current ratings specified in this manual or on the back of the instrument. Failure to do so may damage the instrument, lead to a safety hazard, or cause a fire. Failure to use the specified fuses will void the warranty.

Servicing

CAUTION

Do not substitute parts that are not approved by B&K Precision or modify this instrument. Return the instrument to B&K Precision for service and repair to ensure that safety and performance features are maintained.

Cooling fans

CAUTION

This instrument contains one or more cooling fans. For continued safe operation of the instrument, the air inlet and exhaust openings for these fans must not be blocked nor must accumulated dust or other debris be allowed to reduce air flow. Maintain at least 25 mm clearance around the sides of the instrument that contain air inlet and exhaust ports. If mounted in a rack, position power devices in the rack above the instrument to minimize instrument heating while rack mounted. Do not continue to operate the instrument if you cannot verify the fan is operating (note some fans may have intermittent duty cycles). Do not insert any object into the fan's inlet or outlet.

Use correctly sized wires

WARNING

To connect a load to the power supply, use a wire diameter large enough to handle the maximum continuous output short-circuit current of the power supply without the wire overheating.

For continued safe use of the instrument

Do not place heavy objects on the instrument.

Do not obstruct cooling air flow to the instrument.

Do not place a hot soldering iron on the instrument.

Do not pull the instrument with the power cord, connected probe, or connected test lead.

Do not move the instrument when a probe is connected to a circuit being tested.

Compliance Statements

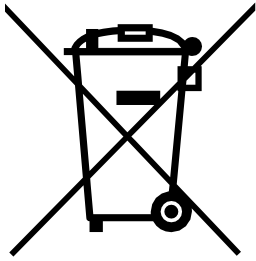

Disposal of Old Electrical & Electronic Equipment (Applicable in the European Union and other European countries with separate collection systems) This product is subject to Directive 2002/96/EC of the European Parliament and the Council of the European Union on waste electrical and electronic equipment (WEEE), and in jurisdictions adopting that Directive, is marked as being put on the market after August 13, 2005, and should not be disposed of as unsorted municipal waste. Please utilize your local WEEE collection facilities in the disposition of this product and otherwise observe all applicable requirements.

CE Declaration of Conformity

This instrument meets the requirements of 2006/95/EC Low Voltage Directive and 2004/108/EC Electromagnetic Compatibility Directive with the following standards.

Low Voltage Directive

1. UL 61010-1:2012

EMC Directive

2. EN 55011:2009+A2:2010
3. EN 61000-3-11: 2000
4. EN 61000-3-12: 2011
5. EN 61000-4-2 / -3 / -4 / -5 / -6 / -8 / -34
6. EN 61326-1: 2013
7. EN 61326-2-1: 2013

Safety Symbols



Refer to the user manual for warning information to avoid hazard or personal injury and prevent damage to instrument.



Electric Shock hazard



On (Supply). This is the AC supply connect/disconnect switch on the front of the instrument.



Off (Supply). This is the AC mains connect/disconnect switch on the front of the instrument.



Direct current



Alternating current



Fuse Symbol



Chassis (earth ground) symbol



Ground terminal



Protective earth ground



CAUTION indicates a hazardous situation which, if not avoided, will result in minor or moderate injury



WARNING indicates a hazardous situation which, if not avoided, could result in death or serious injury



DANGER indicates a hazardous situation which, if not avoided, will result in death or serious injury.

Table of Contents

Safety Summary	1
Category rating	1
Compliance Statements	7
CE Declaration of Conformity	8
Low Voltage Directive.....	8
EMC Directive	8
Safety Symbols	9
Table of Contents	10
1 General Information	13
1.1 Features:	13
1.2 Package Contents	13
1.3 Product Dimensions.....	14
1.4 Front Panel Overview	14
1.4.1 Front Panel Description.....	15
1.5 Keypad Overview	15
1.5.1 Keypad Description	15
1.6 Rear Panel Overview	17
1.6.1 Rear Panel Description.....	17
1.7 Display Overview.....	18
1.7.1 Display Description.....	18
2 Getting Started	19
2.1 Input Power and Fuse Requirements.....	19
2.1.1 Input Power	19
2.1.2 Fuse Replacement	22
2.2 Rackmount Installation	22
2.3 Output Connections	22
2.4 Preliminary Check.....	23
2.4.1 Warm-up Time	23
2.4.2 Output Check.....	23
2.4.3 Check Model and Firmware Version	25
3 Front Panel Operation	27

3.1	Menu Options	27
3.1.1	How to Access the Menu	28
3.2	Configure Voltage/Current Output	28
3.2.1	Setting Voltage	28
3.2.2	Setting Current	29
3.2.3	Remote Sense	29
3.3	Voltage/Current Measurement	31
3.4	CONFIG Menu	32
3.4.1	Output Limit Settings	32
3.4.2	Protection Settings	33
3.4.3	Configure Over Power Protection (OPP)	34
3.4.4	External Analog Control	36
3.4.5	External Control Setting	38
3.4.6	Enable Control	39
3.4.7	Power OK Signal	39
3.5	Voltage Program	40
3.5.1	Voltage Mode	40
3.5.2	Resistor Mode	40
3.6	Parallel Operation	42
3.6.1	Master Unit	44
3.7	PV Simulation	46
3.8	Power-On State	48
3.9	Communication Configuration	48
3.10	SYSTEM Menu	48
3.10.1	Enable/Disable Key Sound	48
3.10.2	Restore Factory Default Settings	49
3.11	Save/Recall Instrument Settings	51
3.11.1	Save Settings	51
3.11.2	Recall Settings	51
3.12	Program Function	52
3.12.1	Configure Program Parameters	52
3.13	Timer Function	55
3.14	Slew Rate Setting	56
4	Remote Operation	57
4.1	Interface Configuration	57
4.1.1	USB	57
4.1.2	USBVCP:	58
4.1.3	USBTMC:	58
4.1.4	RS232	58

4.1.5	GPIB	59
4.1.6	RS485.....	60
4.1.7	LAN (Ethernet).....	61
4.1.8	Web server	62
4.2	Error/Event List.....	65
5	Calibration.....	67
5.1	Voltage Calibration	68
5.2	Current Calibration.....	69
5.3	OVP Calibration	69
5.4	OCP Calibration	70
5.5	External Voltage Programming Calibration	71
5.6	External Current Programming Calibration.....	72
5.7	CC Calibration of External Voltage	72
5.8	CC Calibration of External Current	73
6	Troubleshooting Guide	75
6.1	General	75
7	SERVICE INFORMATION	76

1 General Information

B&K Precision models MR25080, MR50040, and MR100020 are high voltage programmable DC power supplies with single outputs that offer the maximum power output up to 5000 watts (0 - 250 V / 80 A or 0 - 500 V / 40 A or 0 - 1000 V / 20 A). By connecting up to *50 power supplies in parallel, a maximum output power can reach up to 250 kW. These power supplies are fully programmable and controllable through analog programming, USB, RS232, RS485, GPIB and Ethernet interface. The front numerical keypad and rotary knob provide a convenient interface for adjusting voltage, current, operating functions and enabling/disabling the output. The MR series power supplies also provide over voltage protection (OVP) and over current protection (OCP) features used to keep the output voltage and current within a specified safety level and preventing damage to the UUT (Unit Under Test).

1.1 Features:

8. High power output of up to 5000 watts(0-250V/80A) (0-500V/40 A) (0-1000V/20 A)
9. USBVCP(virtual COM)/USBTMC/RS232/RS485/Analog/GPIB and Ethernet interfaces
10. Parallel connectivity for up to *50 units
11. Adjustable voltage and current slope
12. 9 user defined programs with up to 100 steps each
13. OVP, OCP, OPP, CV to CC, and CC to CV protection
14. Store/recall up to 100 sets of voltage/current settings

*Parallel connectivity and operations can be configured in several different modes, however speed and performance will decrease as each additional units are paralleled together. Refer to section 3.6 [Parallel Operation](#) and 4.1 [RS485](#) for more details regarding the configuration, setup, and limitations.

If you wish to connect more than 10 units in parallel, we advise to contact us at www.bkprecision.com for further assistance.

1.2 Package Contents

Please inspect the instrument mechanically and electrically upon receiving it. Unpack all items from the shipping carton, and check for any obvious signs of physical damage that may have occurred during transportation. Report any damage to the shipping agent immediately. Save the original packing carton for possible future reshipment. Every power supply is shipped with the following contents:

15. 1 xMR25080, MR50040, or MR100020 Power Supply
16. 1 x AC Power Cord
17. 1 x Certificate of Calibration

18. 1 x Test Report

Verify that all items above are included in the shipping container. If anything is missing, please contact B&K Precision.

1.3 Product Dimensions

The MR25080, MR50040, and MR100020 power supply's dimensions are approximately: 420mm (16.54in) x 88mm (3.46in) x 532mm

(20.95in) (WxHxD). These 2U supplies are designed to fit in a standard 19-inch rackmount.

Note: All dimensions in the figures [below](#) are measured in millimeters (mm).

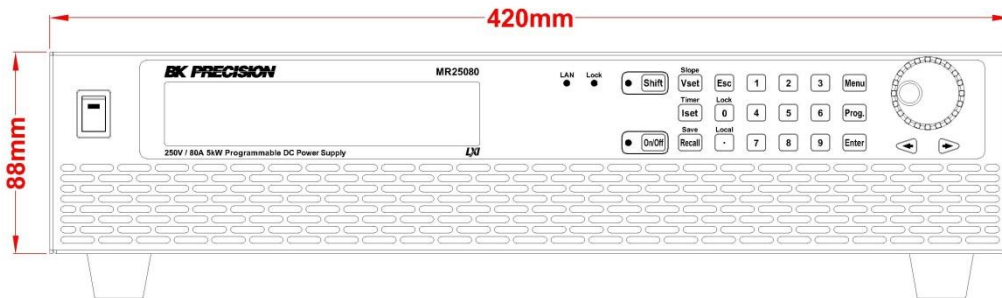

Figure 1.1 – Front Panel Dimensions

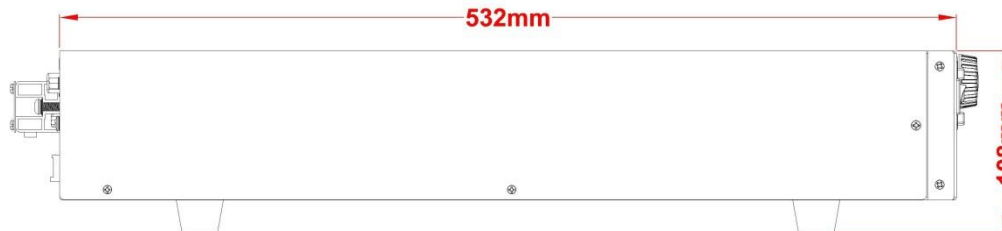

Figure 1.2 – Side Panel Dimensions

1.4 Front Panel Overview

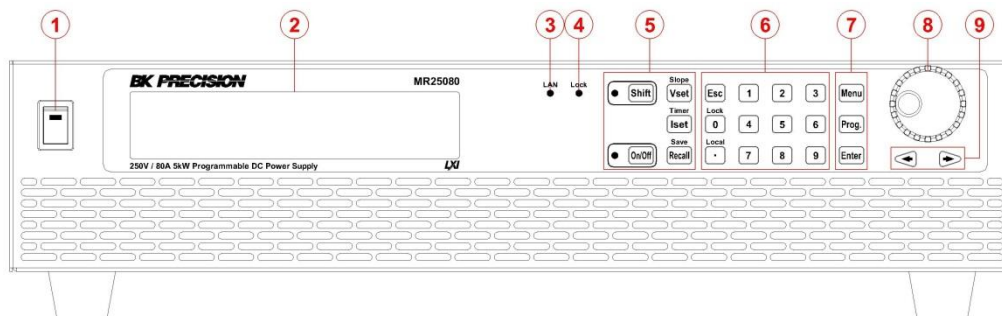

Figure 1.3 – Front Panel Overview

1.4.1 Front Panel Description

- 1 Power On/Off switch
- 2 Vacuum Fluorescent Display
- 3 LAN Status indicator
- 4 Keypad lock indicator
- 5 Function keys
- 6 Numeric keys
- 7 Function keys
- 8 Rotary Knob
- 9 Left, Right cursor keys

1.5 Keypad Overview

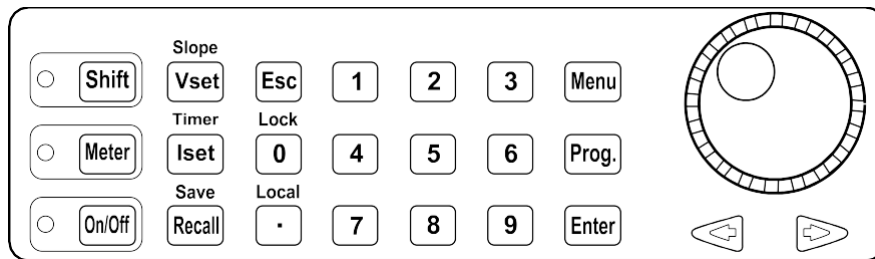





Figure 1.4 – Keypad Overview

1.5.1 Keypad Description

-  **Shift key**
Enables access to secondary functions (Labeled in blue)
-  **On/Off**
Controls the output state.
-  **Vset / Slope**
Configures output voltage or sets the rise and fall times of the output voltage
-  **Iset / Timer**
Configures output current or setup the timer setting.



Recall / Save button

Saves and recalls instrument settings.



Escape button

Exits menu settings.



Zero / Lock button

Inputs a value of zero or locks the front panel buttons.



Decimal / Local button

Inputs a decimal point for values or sets the instrument back to local mode

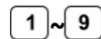

Numeric keypad

Enters numeric values for various parameters.



Menu button

Allows access to the power supply menu settings.



Program button

Enters program mode settings menu.



Enter

Confirms setting/parameter changes.



Rotary Knob

Adjusts numeric settings or selects menu items.



Left/Right arrow keys

Adjusts cursor position or select menu items.

1.6 Rear Panel Overview

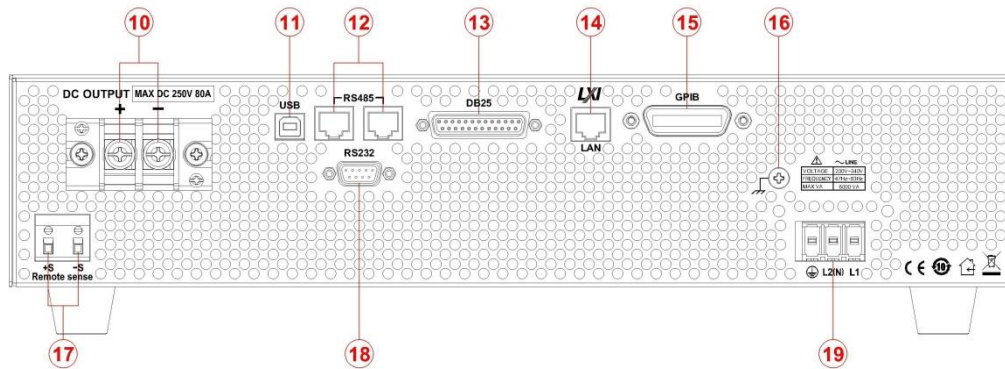

Figure 1.5 – Rear Panel Overview

1.6.1 Rear Panel Description

- 10 **Output**
- 11 **USB interface**
- 12 **RS-485 interface**
- 13 **Analog programming interface (DB25 connector)**
- 14 **Ethernet (LAN) interface**
- 15 **GPIB interface**
- 16 **Earth ground connection**
- 17 **Remote sense terminals**
- 18 **RS-232 interface**
- 19 **AC input receptacle**

1.7 Display Overview

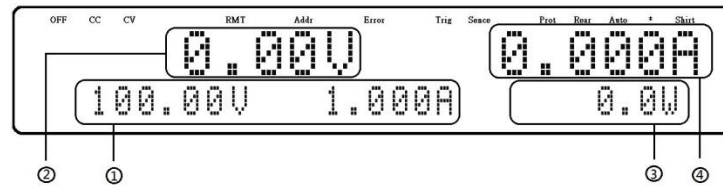

Figure 1.6 – Display Overview

1.7.1 Display Description

- 1 **Measured voltage**
- 2 Settings voltage and current
- 3 Measured power output
- 4 Measured current
- OFF Indicates output is disabled
- CC Indicates constant current (CC) operation
- CV Indicates constant voltage (CV) operation
- RMT Indicates remote mode
- Addr Indicates remote communication activity
- Error Indicates an error has occurred
- Shift Indicates shift mode (**access to secondary button functions**)

2 Getting Started



Before connecting and powering up the instrument, please review and go through the instructions in this chapter.

2.1 Input Power and Fuse Requirements

2.1.1 Input Power

The supply has a universal AC input that accepts line voltage input within:

AC Input: 210 V – 240 V

Frequency: 47 Hz – 63 Hz

Before connecting to an AC outlet or external power source, be sure that the power switch is in the OFF position and verify that the AC power cord, including the extension line, is compatible with the rated voltage/current and that there is sufficient circuit capacity for the power supply. When the AC input voltage is lower than the full-load voltage, which is 200VAC, the supplies will activate an inner over temperature protector and cut off the output in response to the condition. To ensure that the entire test process can be completed smoothly, confirm that the input AC voltage is within the specified range. Once verified, connect the cable firmly.

WARNING

The included AC power cord is safety certified for this instrument operating in rated range. To change a cable or add an extension cable, be sure that it can meet the required power ratings for this instrument. Any misuse with wrong or unsafe cables will void the warranty.



SHOCK HAZARD:

The power cord provides a chassis ground through a third conductor. Verify that your power outlet is of the three-conductor type with the correct pin connected to earth ground.

Follow the instructions below to connect the AC power cable to the AC input of the power supply in the rear panel.

1. First, connect the input receptacle (green terminal block) of the cable to the input terminals of the power supply.
2. Align the power cord housing mounting holes on the left and right side to the screw holes on the power supply.
3. Use only the included screws to fasten and secure the cable housing assembly.

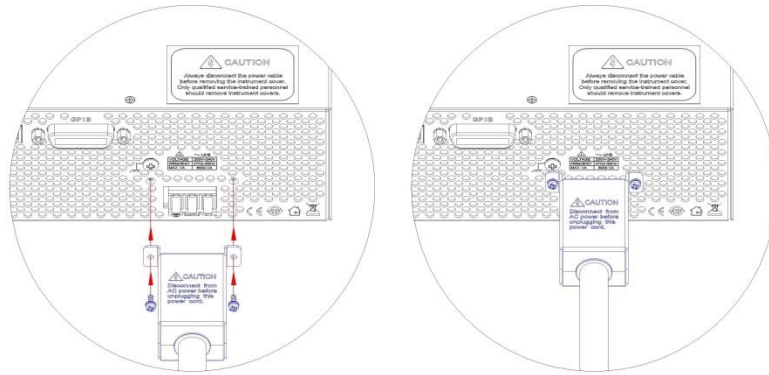

Figure 2.1 – AC Power Connection Diagram

Refer to the descriptions below to connect the other end of the AC power cord to the AC distribution panel.



Do NOT plug the AC power cord into the wall socket prior to connecting ALL three AC power wires to the rear panel and securely mount the safety metal housing over the input receptacle. Doing so may create a shock hazard.

Connection of this power supply to an AC power source should be made by a qualified electrician or other qualified personnel. Incorrect wiring may damage the power supply or cause a fire hazard



Connect the three terminals black to line 1 (L1), white to line 2 (L2) or neutral (N), and green to ground (G) on the other end of the power cord to your AC distribution panel.

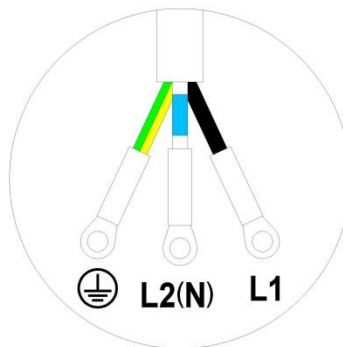

Figure 2.2 – AC Power Cord



Safety agency requirements dictate that there must be a way to physically disconnect the AC mains cable from the unit. A disconnect device, either a switch or circuit breaker must meet the input rating requirements at 30A in 200 Vac. The disconnect device provided in the final installation must be close to the instrument, must be easily accessible, and must be marked as the disconnect device for this instrument.

2.1.2 Fuse Replacement

⚠ WARNING

This power supply does not require a fuse that is user replaceable. There is an internal fuse, in which if blown, may indicate a malfunction in the unit. In this event, contact B&K Precision.

Any disassembling of the case or changing the fuse not performed by an authorized service technician will void the warranty of the instrument. ___

2.2 Rackmount Installation

The MR series power supplies are designed to fit in a space of two rack units (2U) and can be mounted in a standard 19-inch rack panel or cabinet. Rack mount brackets must be assembled before mounting the unit in a rack. Refer to the following figure to assemble the rack mount brackets.

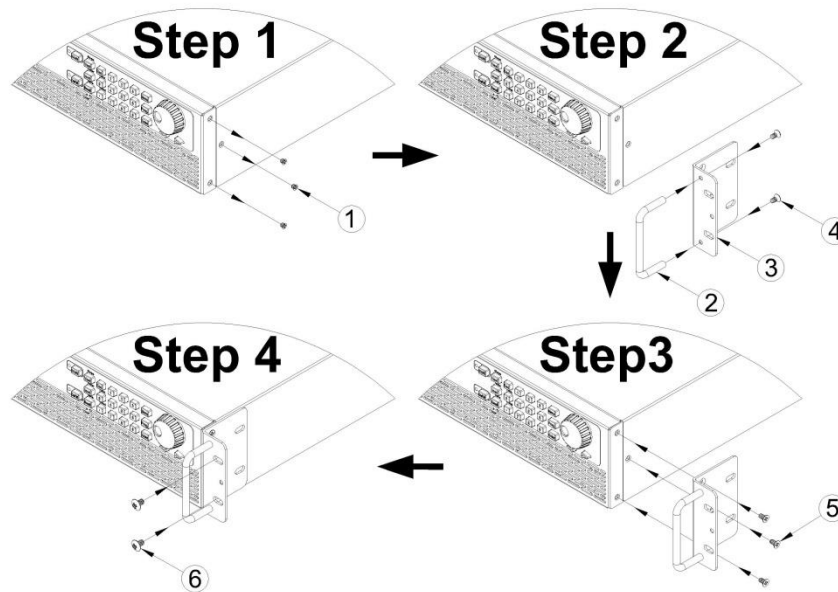

Figure 2.3 – Rack Mount Bracket Assembly

2.3 Output Connections

The main DC output terminal is a screw type terminal block located in the rear panel.

Due to the high current rating of the power supply, proper wire sizes are necessary for safe connectivity and to prevent wires from overheating. Refer to the below table as a reference for proper wire sizes according to the amount of current used for operation:

AWG	6	8	10	12	14	16	18	20	22
I_{max}(A)	75	55	40	25	20	13	10	7	5
mΩ/meter	1.3	2.1	3.3	5.2	8.3	13.2	21	33.5	52.8

Table 1 – Wire Gauge Rating

WARNING

Before connecting wires to the output terminals, turn OFF the power supply to avoid damage to the instrument and the device under test (DUT). For safety, load wires must have a wire gauge size large enough to prevent overheating when the power supply operates at maximum short circuit output current. It will also prevent large voltage drops from resistances in the wires.



SHOCK HAZARD:

Hazardous voltages may exist at the outputs and the load connections when using a power supply with a rated output greater than 40V. To protect personnel against accidental contact with hazardous voltages, ensure that the load and its connections have no accessible live parts. Ensure that the load wiring

insulation rating is greater than to the maximum output voltage of the power supply.

2.4 Preliminary Check

Complete the following steps to verify that the power supply is ready for use.

1. Verify AC input voltage

Verify and check to make sure proper AC voltages are available to power the instrument. The AC voltage range must meet the acceptable specification as explained in “2.1 Input Power and Fuse Requirements”.

2. Connect power

Connect AC power cord to the AC receptacle in the rear panel and press the power switch to the I (ON) position to turn ON the instrument. On power up, the unit will display its model, shown in the screen below, and then check for the optional modules.

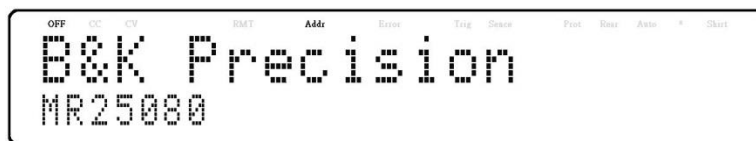

2.4.1 Warm-up Time

The MR series is fully operable upon switching the power ON. However, to reach the specified equipment accuracy, please allow the supply to warm up for at least 15 minutes.

2.4.2 Output Check







2.4.2.1 Voltage Check

Follow the steps below to check voltage output with no load connected.

1. Turn ON the power supply. The display will show the OFF annunciator above the voltage display.
2. Enable the output by pressing , and the LED next to the button will be lit. The OFF annunciator will change to CV.
3. Using the numeric keypad or the voltage adjust knob and enter a voltage value. The voltage display will now show the value you entered. If entering with numeric keypad, press first, then enter the value and press .
4. (Optional) You may also verify the output voltage by connecting the (+) and (-) terminals on the rear panel to an external voltmeter. The measured value should match or be within the entered voltage value.





2.4.2.2 Current Check

Follow the steps below to check current output of the power supply.

1. Turn ON the power supply. The display will show the OFF
2. annunciator above the voltage display. Be sure that the output is disabled (the LED next to the  button should not be lit when it is off). If the LED is ON, press  to disable output. Short the (+) and (-) output terminals with test leads, shorting bar, or clip. (Refer to "[- Wire Gauge Rating](#)" to select appropriate test leads)
3. Using the numeric keypad or the current adjust knob, enter a small current value (i.e. 1.000 A). If entering with numeric keypad, press  first, then enter the value and press . The current display will now show the value you entered.
4. Enable the output by pressing , and the LED next to the button will be lit. The OFF annunciator will change to CC.
5. (Optional) You may also verify the output current by connecting either the (+) and (-) terminals on the rear panel to an external current meter capable of measuring the current that you set. The measured value should match or be within the entered current value.
6. Press the power switch to  (OFF) position to turn off the power supply, then remove the short on the output terminals.

2.4.3 Check Model and Firmware Version

The model and firmware version can be verified by using the *IDN? query remote command. It can also be found from within the menu system by following these steps:

1. Press  to enter the menu system.
2. Press the  button five times until **SYSTEM** is select. Press . Press the  button one time until **INFORMATION**. Press , and the display will show the following screen:

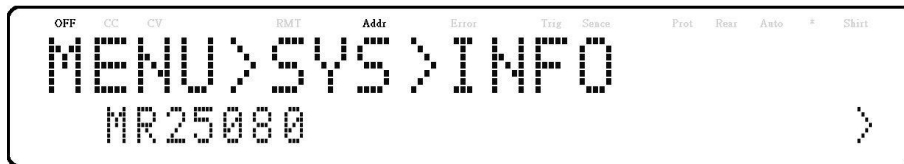

3. The model is shown above as MR25080.
4. Press  twice again and the firmware version will displayed.

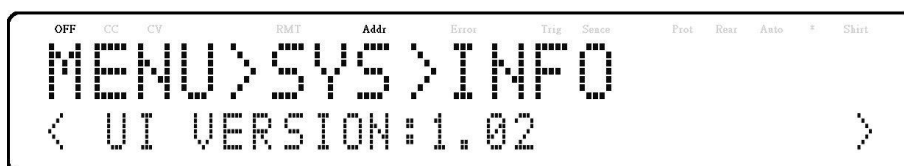

5. The UI firmware is shown above as 1.02.

6. Press  once again and the firmware version will displayed.

```
OFF  CC  CV      RMT  Addr  Error  Trig  Sense  Prot  Rest  Auto  *  Shift
MENU>SYS>INFO
< CONTROL VERSION:1.02 >
```

7. The control firmware is shown above as 1.02.

8. Press  once again and the firmware version will displayed.

```
OFF  CC  CV      RMT  Addr  Error  Trig  Sense  Prot  Rest  Auto  *  Shift
MENU>SYS>INFO
< INTERFACE VERSION:1.01 >
```

9. The interface firmware is shown above as 1.01.

10. Press  once again and the firmware version will displayed.

```
OFF  CC  CV      RMT  Addr  Error  Trig  Sense  Prot  Rest  Auto  *  Shift
MENU>SYS>INFO
< PFC VERSION:1.H0 >
```

11. The PFC firmware is shown above as 1.52.

12. Press  three times to exit the menu and return to the normal display.

3 Front Panel Operation

3.1 Menu Options

All settings and parameters can be configured from the built-in menu system of the power supply.

To access the menu, press .

The menu system is divided into 5 sections and are organized as follows:

CONFIGURATION

LIMIT	Configures voltage setting limits.
PROTECT	Configures OVP, OCP, OPP, CVtoCC, and CCto CV protection.
EXT CONTROL	Configures external analog control.

PARALLEL

Configures parallel connection and master/slave mode.

PV SIMULATION

Configures photovoltaic array simulator function.

POWER-ON STATE

Configure power-on state.

COMMUNICATION

Select and configure communication interface.





USB
GPIB
LAN
RS485
RS232

SYSTEM





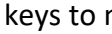

BEEP	Enable/Disable key sound.
INFORMATION	Shows model, firmware version, communications settings, optional modules install and other power supply information.
CALIBRATION	Calibration menu.
DEFAULT	Select memory location for save/recall instrument settings.

3.1.1 How to Access the Menu

Before using the instrument, it is important to be familiarized with its menu structure and learn how to view or change settings and parameters. Follow the steps below to guide you in selecting menu options.

- 1  From the normal display, press  to enter the menu.
- 2 The selected item will be show. Use  keys to move through the menu selections.
- 3 When the desired menu section is show, press  to access its menu settings. Below is the display when SYSTEM is selected.



- 4 The selected item will be show. Use the  keys to move through the menu items. When there is a  on the right side of the display, that means there are more menu items available to select from. Similarly, a  will appear on the left side of the display when there are menu items to the left. Use the  keys accordingly to select the desired menu item.
- 5 Press  to access the selected menu item.
- 6 There may be parameters or options to select within each menu item. Follow the same instructions as described in the previous steps to select them. To save changes to a setting, press .
- 7 To exit the menu at any time, press  until the normal.



3.2 Configure Voltage/Current Output

Voltage and current can be set from the front panel. Remote sense is also available on the rear panel for voltage compensation at the output.

3.2.1 Setting Voltage

Follow the steps below to set the output voltage:



1. From the normal front panel display, users can use either the voltage adjust knob or the numeric keypad to enter the setting voltage.

2. If entering using numeric keypad, press  first so that the cursor selects the voltage display. Then, enter the value and press  to set the voltage.
3. To change the cursor position to adjust with the voltage adjust knob, use the  keys to move left or right.

When output is ON, the user can use the rotary to adjust the voltage value when the output is in constant voltage (CV) mode. The output value will change simultaneously with the adjusted value. This is so called on-the-fly function that allows user to easily change the output value if the test is needed.

3.2.2 Setting Current

Follow the steps below to set the output current:

- 1 From the normal front panel display, users can use either the current adjust knob or the numeric keypad to enter the setting current.
- 2 If entering using numeric keypad, press  first so that the cursor selects the current display. Then, enter the value and press  to set the current.
- 3 To change the cursor position to adjust with the voltage adjust knob, use the  keys to move left or right.

When output is ON, the user can use the rotary to adjust the current value when the output is in constant current (CC) mode. The output value will change simultaneously with the adjusted value. This is so called on-the-fly function that allows user to easily change the output value if the test is needed.

3.2.3 Remote Sense

Remote sense can be used to compensate for voltage drops up to 5 V (MR25080) or 10V (MR50040) or 20V (MR100020) due to resistance from test leads connected to your device under test (DUT), thus providing more accurate output voltage. The power supply is initially set up for local sense mode by default. Refer to the following sections for details of local and remote sense setup.

3.2.3.1 Local Sense

By default, the power supply is set up for local sense. This is determined by the wire connections in the rear panel, illustrated below:

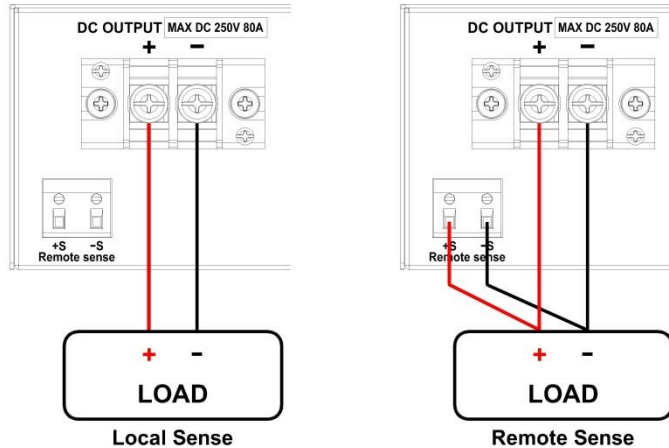

Figure 3.1 – Local/Remote Sense Connection Diagram

When local sense is selected, the positive lead (+) of the DC output is connected to the positive end (+) of the load and the negative lead (-) of the DC output is connected to the negative end (-) of the load.

When this sensing mode is selected the wires connecting between DC outputs to the load must be as short as possible. The local sense is the default configuration.

⚠ WARNING

DO NOT disconnect the wires if remote sense is not used. Doing so will cause erratic behavior and may damage the power supply under certain conditions.



Never connect any power source into any of the four terminals at any time during operation.

When output is enabled, DO NOT use your hand to touch the terminals or the screws that are designed to tighten wires to the terminals. Doing so may create a shock hazard under high voltage output conditions.

3.2.3.2 Remote Sense

When remote sense is selected, the positive sense (+S) and positive lead (+) of the DC output are connected to the positive end (+) of the load, whereas negative sense (-S) and negative lead (-) of the DC output are connected to the negative end (-) of the load.

To enable remote sense, follow the steps below:

- 1 Power OFF the supply and disconnect all loads and cables connected to it.
- 2 Use a small flat blade screwdriver connect the S+ to the DUT's positive (+) terminal, and connect the S- to the DUT's negative (-) terminal.
- 3 Do not connect any wires to Vo+ and Vo- terminals.

- Power ON the power supply, and then configure and enable the output. The setup should look like the figure [above](#).

⚠ CAUTION **DONOT** at any time disconnect the wires from the Vs+ and Vs- terminals to the DUT while output is enabled (ON). Doing so may damage the power supply and cause unstable output.

3.3 Voltage/Current Measurement

The display will show the set voltage and current values and the measured values of the output.

System Messages

The MR has built-in sensors to detect system conditions. If a fault status occurred, the error message will show on the display and automatically protect the power supply output. The following display occurs when the fan has failed or stopped turning:

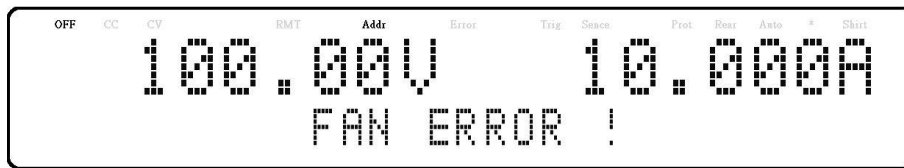

The following table shows the various messages that may alert the user:

System message	Description
MEMORY CHECK ERROR !	Cannot read or write the internal non- volatile memory
OVER TEMPERATURE PROTECT !	Internal temperature is too high and the protection mechanism is activated
FAN ERROR !	FAN not functioning
HW Fail OVP	Module hardware over voltage
HW Fail OCP	Module hardware over current
CALIBRATION ERROR !	Calibration cannot be done
AC FREQUENCY ABNORMAL !	AC input frequency is out of range
AC VOLTAGE ABNORMAL !	AC input voltage is out of range

PFC ERROR !	PFC not functioning correctly
POWER OFF !	Power supply is powering off
OUTPUT SHORT CIRCUIT	Output voltage drop too fast
HW Fail BVbus	Module hardware fail

3.4 CONFIG Menu

All setup procedures and settings explained in this section can be accessed from the **CONFIGURATION** menu. To access this menu, press **Menu**, select **CONFIGURATION**, then press **Enter**.

3.4.1 Output Limit Settings

The voltage or current output limits can be configured to provide limit protection to prevent accidental changes to the output settings. There are four limit values that can be set: voltage maximum (VMAX), voltage minimum (VMIN), current maximum (IMAX), and current minimum (IMIN).

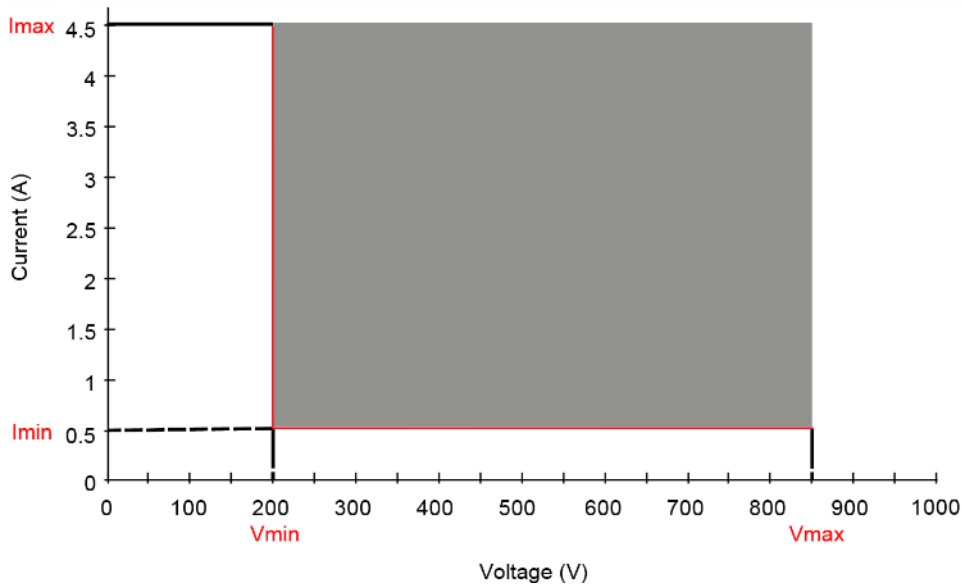

Figure 3.2 – Output Limit Settings Graph

Note: At any time during operation, when you are unable to set to a desired voltage or current, check these limit settings to make sure the set value is within the limit's range.



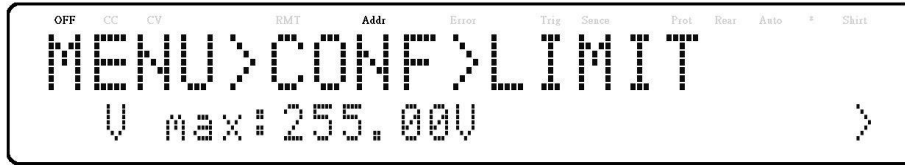

The shaded area illustrated above is the settable range of the output voltage and current.

Follow the steps below to configure the output limits:

- 1 From the **CONFIGURATION** menu, select **LIMIT**, then press **Enter**. The following screen will display:



2









- 3 Use the   keys to select the limit setting value of V max, V min, I max, and I min. Press  to confirm selection.
- 4 Use the numerical keys to set the limit value and press  to confirm the setting.
- 5 Press  several times to exit the menu setting.

3.4.2 Protection Settings

3.4.2.1 Configure Over Voltage Protection (OVP)

The MR over voltage protection utilizes a hardware comparator that quickly protects the instrument when the voltage presented at the output terminal exceeds the OVP setting voltage.

Follow the steps below to set the OVP limit:

1. Press  button, select **CONFIGURATION**, then press .
2. Press  button one time until **PROTECT** is select and press . The display will then show **OVP**, press .
3. Use numerical keys directly or use   keys with rotary adjustment followed by  to confirm the OVP value.
4. Press  several times to exit the menu setting.

When OVP protection is tripped during operation, the output will turn off and the following OVP status message will display:











To clear the trip status, press  once.

3.4.2.2 Configure Over Current Protection (OCP)

The MR overcurrent protection utilizes a hardware comparator that quickly protects the instrument when the current presented at the output terminal exceeds the OCP setting current.

Follow the steps below to set the OCP limit:

1. Press  button, select **CONFIGURATION**, then press .

2. Press  button one time until **PROTECT** is select and press . The display will then show **OVP**.
3. Press  button one time until **OCP** is displayed, and press .
4. Use numerical keys directly or use   keys with rotary adjustment followed by  to confirm the OCP value.
5. Press  several times to exit the menu setting.

When OCP protection is tripped during operation, the output will turn off and the following OCP status message will display:

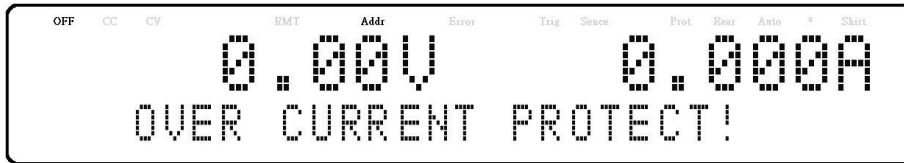











To clear the trip status, press  once.

3.4.3 Configure Over Power Protection (OPP)

The MR overpower protection continuously monitors the output power level. If it is greater than the OPP setting, it turns off the power supply output to protect the device under test.

Follow the steps below to set the OPP limit:

1. Press  button, select **CONFIGURATION**, then press .
2. Press  button one time until **PROTECT** is select and press . The display will then show **OVP**.
3. Press  button two times until **OPP** is displayed, and press .
4. Use numerical keys directly or use   keys with rotary adjustment followed by  to confirm the OPP value.
5. Press  several times to exit the menu setting.

When OPP protection is tripped during operation, the output will turn off and the following OPP status message will display:



To clear the trip status, press **Esc** once.

3.4.3.1 Configure CV to CC Protection

The MR CV to CC protection monitors the transition between constant voltage to constant current mode. If this event occurs, the output of the power supply will turn off.

Follow the steps below to set the CV to CC Protection:

1. Press **Menu** button, select **CONFIGURATION**, then press **Enter**.
2. Press **▶** button one time until **PROTECT** is select and press **Enter**. The display will then show **OVP**.
3. Press **▶** button three times until **CV->CC** is displayed and press **Enter**.
4. Use rotary to select the CV->CCON or OFF followed by **Enter**.
5. Press **Esc** several times to exit the menu setting.

When CV to CC protection is tripped during operation, the output will turn off and the following CV to CC status message will display:

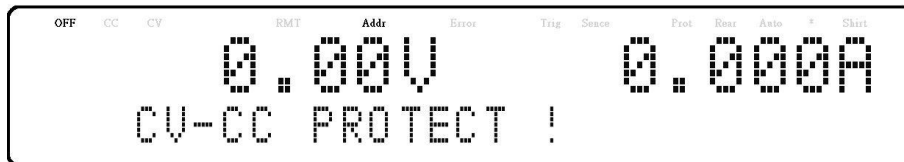

To clear the trip status, press **Esc** once.

3.4.3.2 Configure CC to CV Protection

The MR CC to CV protection monitors the transition between constant current to constant voltage mode. If this event occurs, the output of the power supply will turn off.

Follow the steps below to set the CV to CC Protection:

1. Press **Menu** button, select **CONFIGURATION**, then press **Enter**.
2. Press **▶** button one time until **PROTECT** is select and press **Enter**. The display will then show **OVP**.
3. Press **▶** button four times until **CC->CV** is displayed and press **Enter**.

4. Use rotary to select the CC->CV ON or OFF followed by **Enter**.
5. Press **Esc** several times to exit the menu setting.

When CC to CV protection is tripped during operation, the output will turn off and the following CC to CV status message will display:

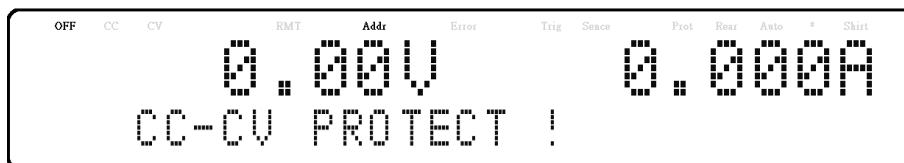

To clear the trip status, press **Esc** once.

3.4.4 External Analog Control

To control or monitor the output of the power supply using external signals, refer to the following figure of the DB25 connector located in the rear panel. The logical signal **b** is a TTL compatible signal. The analog signal **A** cannot exceed the range of 0 to 12VDC.

⚠ WARNING

DO NOT exceed 12VDC on any of the analog signal **A** pins or TTL voltage on any of the logical signal **b** pins of the DB25 connector.

Doing so will cause erratic behavior and may damage the power supply under certain conditions.

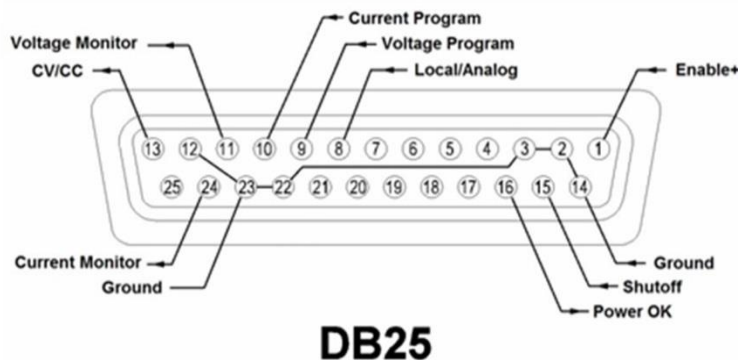

Figure 3.3 – DB25 Pinout

Pin	Signal	I/O	Description
1	Enable	I	Open: Output is OFF Short to ground: Output is ON





Pin	Signal	I/O	Description
2	Ground		
3	Ground		
8	Local/Analog	I	Open: Front panel control Short to ground: Rear analog control
9	Voltage Program	I	Input 0-5 V / 0-5 k Ω or 0-10 V / 0-10 k Ω for voltage output setting, full scale input equals maximum output voltage
10	Current Program	I	Input 0-5 V / 0-5 k Ω or 0-10 V / 0-10 k Ω for current output setting, full scale input equals maximum output current
11	Voltage Monitor	O	Output 0-5 V / 0-10 V represents power supply output voltage, full scale output equals maximum output voltage
12	Ground		
13	CV/CC	O	High: Constant voltage
			Low: Constant current
14	Ground		
15	Shutoff	I	Open: No action Short to ground: OFF: Ignore Shutoff LIVE: Output is OFF LATCH: Output is OFF

Pin	Signal	I/O	Description
16	Power OK	O	High: Output is ON Low: Output is OFF
22	Ground		
23	Ground		
24	Current Monitor	O	Output 0-5 V / 0-10 V represents power supply output current, full scale input equals maximum output current

3.4.5 External Control Setting

If you want to use the external mode to control the power, you must enter the menu configures external analog control before entering the external mode.

Follow the steps below:

1. Press  button, select **CONFIGURATION**, then press .
2. Press  button twice times until **EXT CONTROL** is select and press .
3. Press  button to set Mode.

External Mode	Description
EXT-V	Program the voltage output by connecting an external DC voltage to Pin 9.
EXT-R	Program the voltage output by connecting an external resistor to Pin 9.

4. Press  button to set Range.

External Range	Description
10V/10K	The external voltage range or resistance range used to control the output voltage full scale is 0-10V / 0-10kΩ.
5V/5K	The external voltage range or resistance range used to control the output voltage full scale is 0-5 V / 0-5kΩ.

5. Press  button to set Shut Off (Remote Inhibit).

External Shut Off	Description
OFF	The Inhibit input is ignored.
LIVE	Output follow the state of the Inhibit input.
LATCH	The output remains disabled. The latched INH status bit is cleared by sending the OUTPUT:PROTECTION:CLEAR command or press  button from the front panel.

3.4.5.1 Local/Analog Control

Pin 8 can be used to select the control mode (local or analog) of the power supply's output. When the input command for this pin is at high level (or open), the control mode will be local. When input command for this pin is at low level (or shorted to GND), the control mode will be analog. If you enter external mode, the front panel will be disabled.

3.4.6 Enable Control

When Enable (Pin 1) open, the output is OFF.

When Enable (Pin 1) short to ground, the output is ON.

3.4.7 Power OK Signal

Pin 16 is used to indicate whether a fault condition is present in the power supply. Normally this pin will output a logic high (5V). When a fault occurs, this pin will output a logic low (0V).

Fault conditions are defined as follows:

1. Overvoltage protection
2. Overcurrent protection
3. Overpower protection
4. CVtoCC protection
5. CCtoCV protection
6. Over temperature protection
7. AC line failure
8. Enable signal
9. Shutoff signal
10. Remote failure
11. Output off

12. Hardware protection

3.5 Voltage Program

3.5.1 Voltage Mode

Under voltage mode, the user may control the full scale output voltage value through Pin 9, by inputting a voltage level of 0-5 V (0-5V/0-5k Ω mode) or 0-10 V (0-10 V / 0-10 k Ω mode) as shown below.

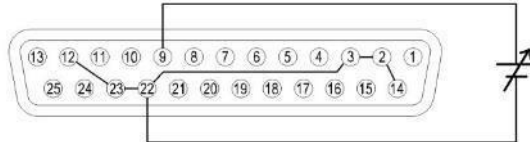

Figure 3.4 – Analog Voltage Programming (Voltage Mode) 0-5 V or 0-10 V

3.5.2 Resistor Mode

Under resistor mode, the user may control the full scale voltage output value by connecting a resistance value of 0-5k Ω (0-5V/0-5k Ω mode) or 0-10k Ω (0-10V/0-10k Ω mode) between Pin 9 and Pin 22 as shown below.

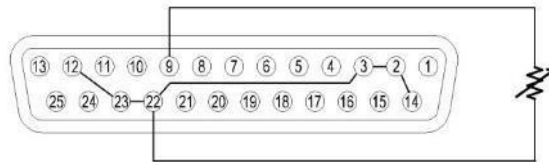

Figure 3.5 - Analog Voltage Programming (Resistor Mode) 0-5 k Ω or 0-10 k Ω

3.5.2.1 Current Program

3.5.2.2 Voltage Mode

Under voltage mode, the user may control the full scale current output value through Pin 10, by inputting a voltage level of 0-5V (0-5V/0-5k Ω mode) or 0-10V (0-10 V / 0-10 k Ω mode) as shown below.

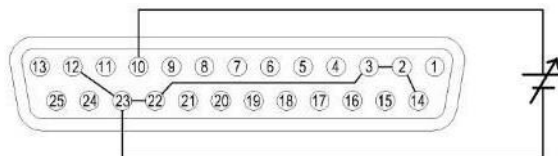

Figure 3.6 - Analog Current Programming Diagram (Voltage Mode) 0-5 V or 0-10 V

3.5.2.3 Resistor Mode

Under resistor mode, the user may control the full scale current output value by connecting a resistance value of 0-5k Ω (0-5V/0-5k Ω mode) or 0-10 k Ω (0-10 V / 0-10 k Ω mode) between Pin 10 and Pin 23 as shown below.

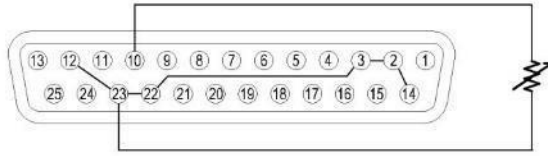

Figure 3.7 - Analog Current Programming (Resistor Mode) 0-5 kΩ or 0-10 kΩ

3.5.2.4 Voltage Monitor

This function is able to monitor the voltage output using Pin 11 and one of the ground pins (i.e. Pin 22), which can be connected to a digital voltage meter (DVM) or other voltage monitoring device, as shown below. The output control must be in analog mode to use this function. The monitoring of the output voltage range (which reflects 0 to full scale of the power supply's output voltage) can be selected between 0-5 V and 0-10 V.

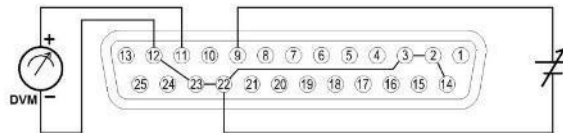

Figure 3.8 - Analog Voltage Monitor

3.5.2.5 Current Monitor

This function is able to monitor the voltage output using Pin 24 and one of the ground pins (i.e. Pin 23), which can be connected to a digital voltage meter (DVM) or other voltage monitoring device, as shown below. The output control must be in analog mode to use this function. The monitoring of the output voltage range (which reflects 0 to full scale of the power supply's output voltage) can be selected between 0-5 V and 0-10 V.

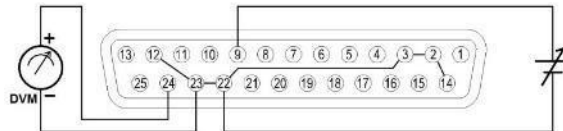

Figure 3.9 - Analog Current Monitor

3.5.2.6 Shut Off Control

Shut off control allows Pin 15 of the DB25 interface to be used to shut off the power supply's output, which is controlled by an input trigger signal.

When shut off occurs, the output will be turned off immediately and **REMOTE INHIBIT !** will appear on the display as shown below. To enable the output again, first set (Pin 15) open.

Then, press or sending the OUTPUT:PROTECTION:CLEAR command before pressing button again to enable the output.

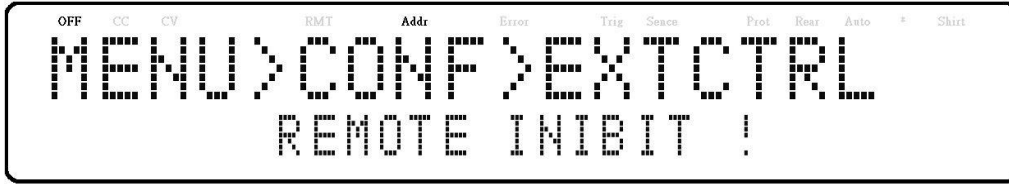

Note: Shut off can only occur when the power supply receives a trigger. Maintaining that pin constantly open will not trigger a shut off.

3.6 Parallel Operation

Connection and Setup

The MR power supplies can be connected in parallel to increase the power output capability as well as the output current. Up to *50 units of the same model can be connected for output up to 250 kW (max). To connect multiple units in parallel, follow the diagram shown below:

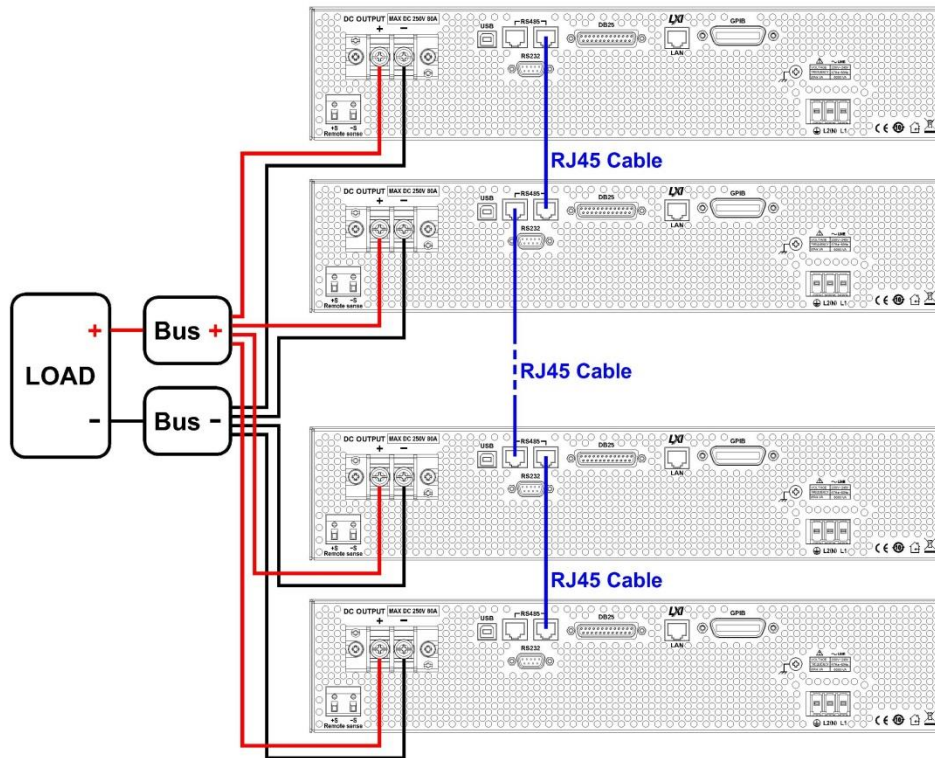











Figure 3.10 – Parallel Connection Diagram

*The power supplies must all be of the same model for parallel operation to function properly. If you want to connect more than 10 units in parallel, we recommend contacting us at www.bkprecision.com for further assistance.

After wiring is complete, configure one of the supplies as the Master and the other slaves (i.e. SLAVE 1 – SLAVE 49). After one of the supplies is configured to be the Master, it will start

searching for all Slaves that are connected to the Master. To operate correctly, the user must set up

the Slaves before the Master. Follow the steps below to set a supply to master or slave mode (Note: Multi-unit connection (chain) mode will be cancelled).

- 1 Press the  button and press the  button one time until PARALLEL is select and press .
- 2 Press  to select the parallel MODE.
- 3 Use the rotary knob to select the setting of OFF or ON and press .
- 4 Press  button one time until Address is select and press .
- 5 Use the rotary knob to set the master or slave and press . Use the same procedure to set up MASTER, SLAVE 1, SLAVE 2,...,SLAVE 49 for the other power supplies.
- 6 Press  several times to exit the menu setting.

Slave Unit

When a power supply is set up to be a slave unit, it will wait for the master's connection, as shown below.

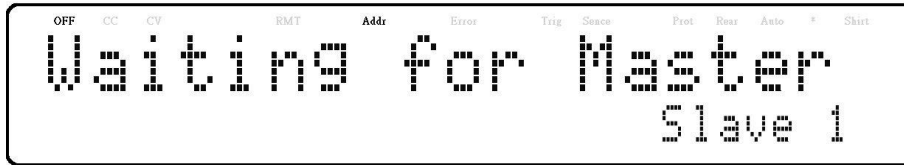

If the master unit has found the slave unit, the slave unit will be controlled by the master unit and the following will be displayed:

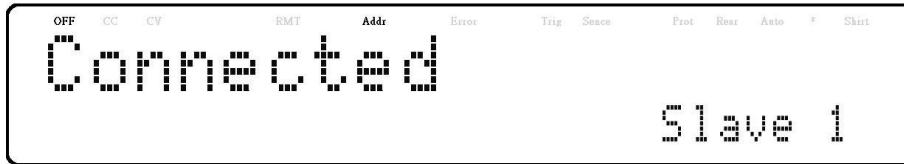

In parallel mode, the slave unit is remote controlled by the master unit. The keypad will be locked.

To exit the parallel mode, press  key to access the parallel mode ON/OFF setting in the menu. Turn off to disable parallel mode control.

3.6.1 Master Unit

After all of the slave units have been set, the master unit can be set by the same procedure with the role set to **MASTER**. As shown below, the master unit will start to search for the slave units.

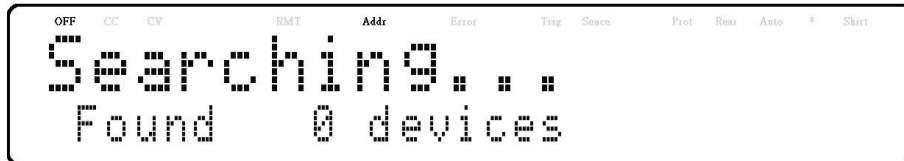

After the search, the master will show how many slave units have been found, as shown in the following display:

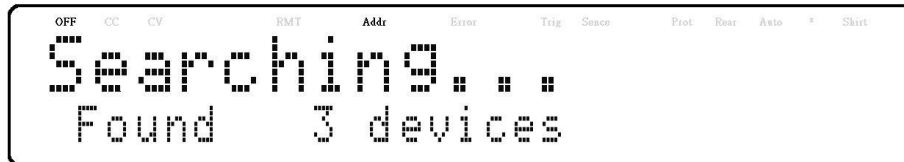

The search is completed will go into parallel mode operation. The following screen should be displayed.

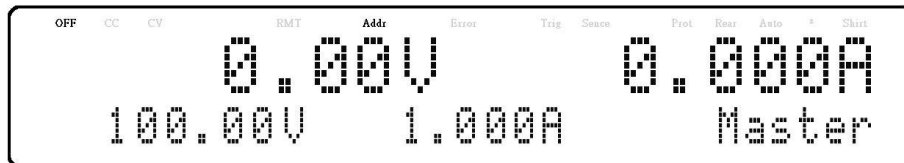

⚠ CAUTION

While in parallel connection mode, the output voltage of each power supply should be set to equal value. If the voltage value of each unit is not the same, the higher output voltage will feed back to the lower voltage unit and damage its internal components.

⚠ WARNING

DO NOT connect multiple power supplies in series as it will cause damage or malfunction.

⚠ CAUTION

When connecting in parallel mode, only the MASTER unit can be controlled by a computer for remote communication. There is also a decrease in speed and performance with each additional SLAVE units connected in parallel and linked together. The voltage and current scan speed, which affects synchronization between the supplies, between the slave units and the master unit will increase based on the following formula:

$$200 + 50 * (N - 1) \text{ (in milliseconds)}$$

where N is the number of units in parallel. Please note as more units are paralleled and linked together, speed will become slower. Thus, we do not recommend paralleling too many units with this setup to ensure fast performance and operation.

If the application requires connecting more than 10 units in parallel operation, we advise to contact us at

www.bkprecision.com for further assistance.

3.7 PV Simulation

Typically, a solar array is connected to an inverter, which converts the panel's output from DC to AC. Due to varying environmental conditions and the nonlinear output of solar cells, many inverters use a maximum power point tracking mechanism to maximize the power generated from the solar panel. Using an actual solar array to test inverters is not cost-effective and environmental conditions are difficult to control in this scenario.

The MR power supply can simulate the output of a solar array with its solar array simulator (SAS) function. Combined with the SAS application software, users can simulate the I-V curve of different arrays under various irradiance conditions while measuring and validating the effectiveness of the inverter's MPPT algorithm.

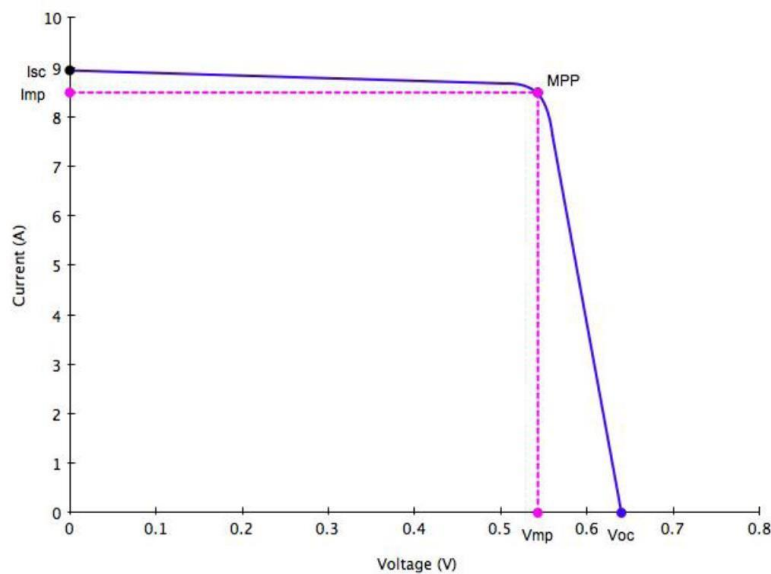

Figure 3.11 – PV Simulation Curve

Solar arrays consist of multiple solar cells characterized by a complex voltage and current profile that is represented in an I-V curve. The I-V curve of a solar array can be generated automatically or manually using one of the following two methods:





- a) Automatically generate the I-V curves by specifying the type of regulation for testing, and the material types such as cSi and TF. The software supports testing against EN50530, SANDIA, and NB/T32004 regulation standards. Up to 101 sets of curve parameters can be created and downloaded to the MR supply's non-volatile memory or entered directly from the front panel. Based on these input parameters, the power supply will then automatically calculate the I-V profile.
- b) Manually generate the I-V curve by creating a user-defined table of points in the SAS software. Up to 4096 I-V points can be downloaded to the MR supply's non-volatile memory.

Once one of these I-V curves has been selected and set from the front panel, the power supply will operate in PV mode and output a voltage and current value according to the active I-V profile and load conditions. Different points on the I-V curve will be output in 1 ms intervals to test the inverter's MPPT efficiency. To create a user-defined table of I-V points and simulate a change in irradiance conditions (e.g. cloudy or rainy day), the PV supply must be controlled by the SAS software. The SAS software also monitors and logs real-time voltage, current, and power as well as real-time and average MPPT efficiency to validate the inverter's MPPT algorithm.

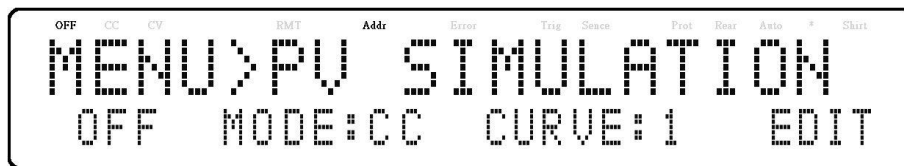

To configure and set the MR power supply to PV mode from the front panel, follow the steps below:

1. Press the **Menu** button and press the  button three times until PV SIMULATION is select, then press **Enter**. The following display will be shown:

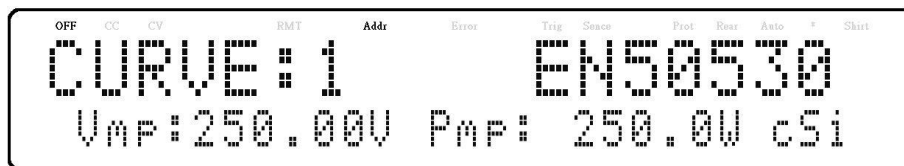

1. Use the  key to move the cursor to the **ON/OFF** field and use the rotary knob to select **ON** or **OFF**. ON means the MR supply is set to PV mode.
2. Use the   keys to move the cursor to the **CURVE** field and use the rotary knob to select the desired curve number. The curve number can be **1-101** or **TABLE** (table of up to 4096 I-V points.)
3. Once again, use the   keys to move the cursor to the **EDIT** field and press **Enter**. The following display will be shown:







4. Use the   keys to move the cursor through the four parameter settings. Use the numerical keys to enter parameter values and press **Enter** to confirm each of the four parameter settings.

Press **Esc** several times to exit the menu setting.

3.8 Power-On State

The initial Power-On state of the power supply can be configured (voltage, current, output state) by following the steps below:



1. From the menu, press  button 3 times to select **POWER-ON STATE** and press .
2. The mode is showing on the display, press  button. There are four options which can be selected using the rotary knob:
 - DISABLE** – Last voltage and current values before power off and output state is OFF.
 - *RST** – Reset output settings, voltage, current, output state, slew rate.
 - LAST** – Last voltage, current, and output state values before power OFF.
 - USER** – User defined voltage, current, and output state.
3. Select one of the settings wanted during power up, and press  to save changes. If **USER** has been selected, set user defined memory and output state.
4. Press  several times to exit the menu setting.

3.9 Communication Configuration

To set up remote interface connections and settings, refer to chapter “4 Remote Operation”.



3.10 SYSTEM Menu

All setup procedures and settings explained in this section can be accessed from the **SYSTEM** menu.

To access this menu, press  and press the  button five times until **SYSTEM** is select, press .

3.10.1 Enable/Disable Key Sound



The instrument initially has key sound enabled from factory. To disable or re-enable the key sound, follow the steps below:

1. From the **SYSTEM** menu, select **BEEP** and press .
2. Select between the two options using the rotary knob:
 - On** – Enable key sound
 - Off** – Disable key sound
3. Select the desired option and press  to save the change.
4. Press  several times to exit the menu setting..

3.10.2 Restore Factory Default Settings

All instrument settings can be reset back to their factory default values by doing the following:

Note: Restoring the instrument to factory default will change all current instrument settings and parameters back to their default values.

1. From the **SYSTEM** menu, press  button 3 times to select **DEFAULT** and press .
2. The instrument will return to the normal display and all settings are now restored back to factory default. The table below lists some of the factory default settings.

Item	Parameter	MR25080	MR50040	MR100020
Output	Voltage	10.0 V	10.0 V	10.0 V
	Current	1.000 A	1.000 A	1.000 A
	State	OFF	OFF	OFF
Protection	OVP Voltage	275.0 V	550.0V	1100.0 V
	OCP Current	88 A	44A	22A
	OPP Power	5200.5 W	5200.5 W	5200.5 W
	CV to CC	OFF	OFF	OFF
	CC to CV	OFF	OFF	OFF
Slope	Voltage	8.33 V/ms	16.67 V/ms	33.33 V/ms
	Current	1000mA/ms	1000mA/ms	1000mA/ms
Parallel	Mode	OFF	OFF	OFF
	Role	MASTER	MASTER	MASTER
External Control	Mode	EXT_V	EXT_V	EXT_V
	Program range	10V/10kΩ	10V/10kΩ	10V/10kΩ
	Shut off	Live	Live	Live
Timer	Mode	OFF	OFF	OFF

Item	Parameter	MR25080	MR50040	MR100020
	HHH:MM:SS	000:00:00	000:00:00	000:00:00
Program	Mode	OFF	OFF	OFF
	Program Number	0	0	0
PV Simulation.	Mode	OFF	OFF	OFF
	Curve	1	1	1
	Control Mode	CC	CC	CC
Power-on State	Mode	Disable	Disable	Disable
	MEM	1	1	1
	Output State	OFF	OFF	OFF
Beep	Mode	ON	ON	ON
Limit	VMAX	255.0 V	510.0 V	1020.0 V
	VMIN	0.0 V	0.0 V	0.0 V
	IMAX	81.6A	40.8 A	20.4 A
	IMIN	0.0A	0.0 A	0.000 A
GPIB	Address	1	1	1
RS232C	Baud	9600	9600	9600
RS485	Baud	9600	9600	9600
LAN	Mode	DHCP	AUTO	AUTO
	IP address	0.0.0.0	0.0.0.0	0.0.0.0
	Mask address	0.0.0.0	0.0.0.0	0.0.0.0

Item	Parameter	MR25080	MR50040	MR100020
	Gateway address	0.0.0.0	0.0.0.0	0.0.0.0
	DNS	8.8.8.8	8.8.8.8	8.8.8.8
	Hostname	Model	Model	Model
	Conflict Number	1	1	1

Table 2 - Factory Default Settings

3.11 Save/Recall Instrument Settings

The instrument can save up to 10 voltage/current values for quick

3.11.1 Save Settings

1. Setup output voltage and current settings that you want to save.

2. Then, press **Shift** and **Recall**. The display will show the following:

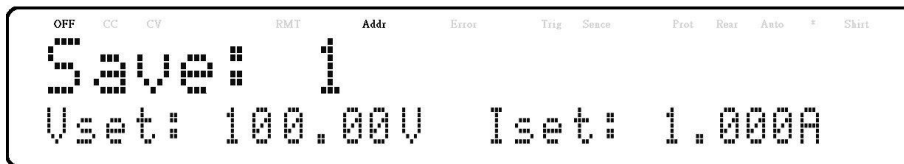

3. Use the current adjust knob or the numeric keypad to enter the memory location in which to store current instrument settings. Select between **1 – 10**. Press **Enter** to save to the selection location.

3.11.2 Recall Settings

1. Press **Recall** to enter the **Recall** mode. The current group number is shown on the display.

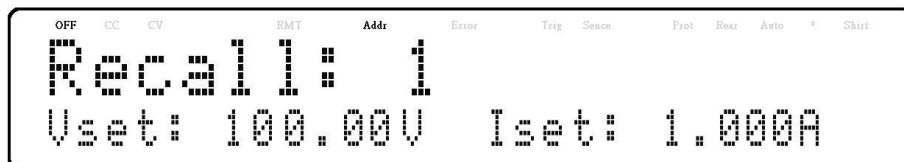

Instrument settings can only be recalled when the instrument enters this mode.

2. Use the keypad to enter the memory location you want to recall. Enter a value between **1** and **10**. The voltage and current settings of that memory location will be shown on the bottom of the display.
3. Once entered, the saved settings at the location will be immediately recalled.

Note: When in Recall mode, users can recall settings from different locations without having to press additional keys each time. For example, you can press 1 to recall settings in location one, and then press 5 to immediately recall settings in location 5.

3.12 Program Function

The MR has a Program feature that allows storing of programs into internal non-volatile memory and recalling and running them per configured parameters. A total of 100 steps can be configured for each program, and a total of 10 programs are available for storage. Additionally, multiple programs or all 10 programs can be saved into a program configuration, where each program configuration allows running one program after another or repeat a finite number of times. This allows for a total of 900 steps in one configuration. Below is an illustration of how programs are structured, stored, and recalled.

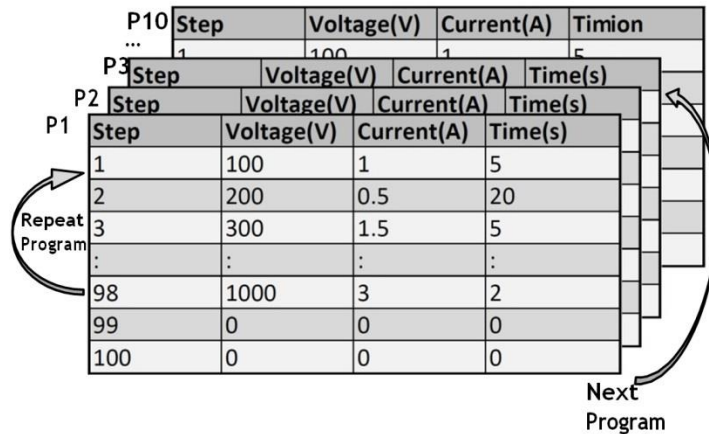

Figure 3.12 – Program Structure Illustration

3.12.1 Configure Program Parameters

3.12.1.1 Options

Users also have the ability to utilize the **REPEAT** and **NEXT** options. The **REPEAT** option allows the user to execute the same program as many times, continuously, as needed. The **NEXT** option allows the user to select the next program to execute once the current program ends. Please be aware that **REPEAT** and **NEXT** options are part of a program, so if one program's **NEXT** option is pointed to a previous program, the power supply will cycle these programs infinitely.

Configure

An example of a program is illustrated below:

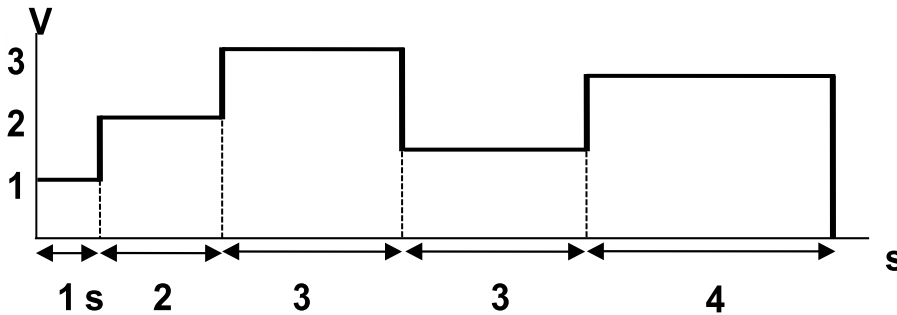
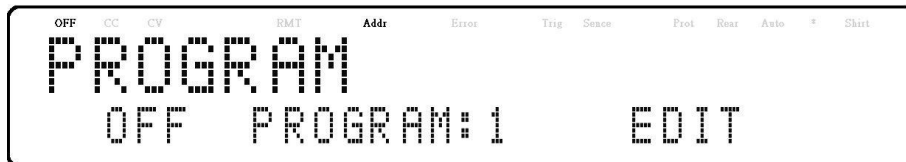





Figure 3.13 – Program Sequence Example

Follow the steps below to set up a program.

1. Press the **Prog.** button to enter the program function settings. The following will be displayed:



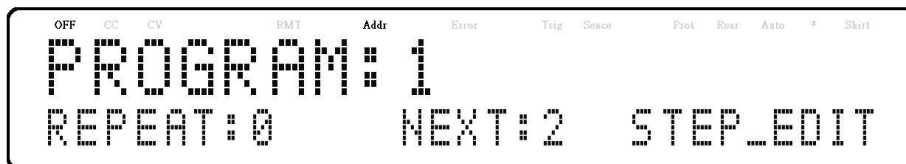

2. Use the rotary knob to select the setting of **OFF** or **ON**.
3. Use the   buttons to move the cursor to the **PROGRAM** selection and use the rotary knob to select a program between 1-10.
4. Use the   buttons to move the cursor to the **EDIT** selection and press **Enter**. The following screen will be displayed:







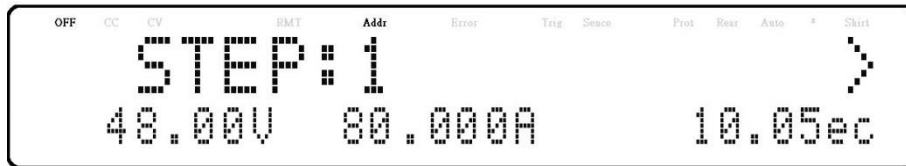

5. Press **Enter**, at this point, the user may select how many times they wish the current program to repeat in the **REPEAT** field, by using the keypad or the rotary knob.

6. Press  to select **NEXT** parameter and use the rotary knob to select a value of **0-10**. As described previously, the user has the ability to queue another program once the current program is finished. By default, 0 is placed as the parameter value, and represent end the program.

7. Press  to select **STEP_EDIT** parameter, pressing , the following will be displayed:



8. As described previously, each step has the following parameters to be edited: voltage, current, and time.

Press  to edit step, use the   buttons to move the cursor to the desired parameter and use the rotary knob or keypad (numeric values only) to change the parameter values. Press  to complete the this step edit. Press  to edit next step, change the step value and continue this procedure for each step for as many steps as needed, or press  several times complete the program configuration.

9. Make sure the program is turned ON and press  to exit the program settings.

10. Once the output state is enabled, by pressing , the program will automatically execute. The following will be displayed when the program is executing:

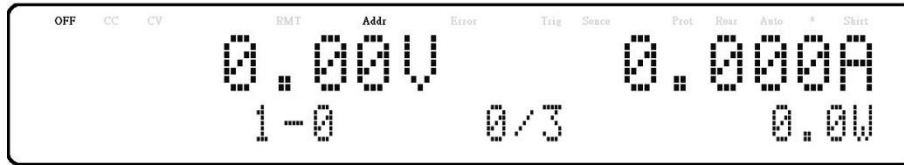

When program mode is running. The current program (1-0 : 1), step (1-0 : 0) and repeat number (0/3 : 3) will also show on the display.

Where p is the program number, step (1-0 : 0) is the step number, repeat number (0/3 : 0) is the present repeated number and repeat number (0/3 : 3) is the total repeat number. For example, if the repeat number is 1/3, this means that there are three repeats of this program and it is now running the first repeat.

3.13 Timer Function

The timer function is a countdown clock, which allows the user to setup how long the output will be enabled when it is initially turned ON.



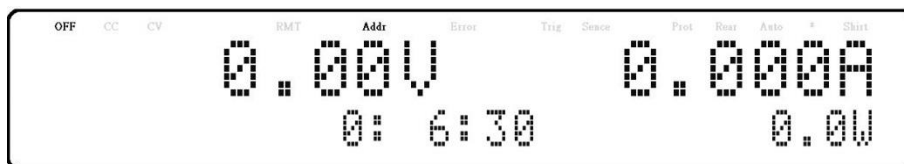

When it is running, a clock on the display counts down until it reaches zero and the output will turn OFF. When the timer is running, the following screen will be displayed:

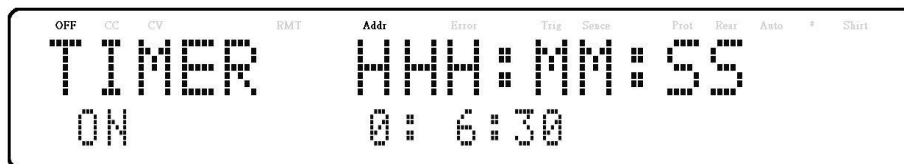

To activate the timer function, follow the steps below:

1. Press the **Shift** and **lset** buttons to enter the timer setup screen. The following will be displayed:



2. Use the   buttons to move the cursor to the desired parameter (hour, minute, and second) and use the keypad to change the parameter values.
3. Use the   buttons to move the cursor to the ON/OFF parameter and use the rotary knob to change ON or OFF.
4. Press **Enter** to complete the timer setting.
5. Pressing the **On/Off** key will enable the output and start the timer.

3.14 Slew Rate Setting

The power supply has the capability of controlling the output voltage and current slew rate. The timing can be configured for the rising/falling edge between voltage and current output transitions.

Follow the steps below to configure the voltage or current slope.

19. Press **Shift** and **Slope Vset** buttons to enter the slope menu.
20. Use the  buttons to select **VOLTAGE** or **CURRENT** and press **Enter** to confirm. The following will be displayed:

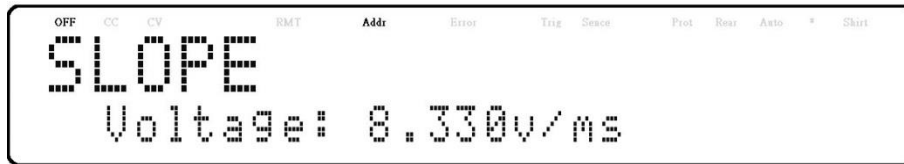

21. Use the keypad or rotary knob to enter the slope value and press **Enter** to confirm.
22. Press **Esc** to exit the slope menu.

4 Remote Operation

There are several interfaces available for remote communication: USB, RS232, GPIB, Ethernet, and RS485. With all these interfaces, this power supply is very flexible to be controlled remotely. Users can program the power supply by using the SCPI (Standard Commands for Programmable Instruments) commands over any one of the remote interfaces. This section will describe how to set up all of the supported interfaces.



Note: The RMT indicator will appear on display when the power supply is successfully connected to a PC remotely through any remote interface. Keys on the front panel will be locked until the instrument is in LOCAL mode. To return to LOCAL mode from the front panel, press . The RMT indicator will disappear when the instrument is in LOCAL mode.

4.1 Interface Configuration





4.1.1 USB

The MR series supports USBVCP and USBTMC functions on USB port. The USBVCP and USBTMC function only one on USB port at the same time.

Follow the steps below to select USBVCP or USBTMC function.

1. From the menu, select Communication and press .
2. When USB is select, press  to select USB. The following display will be shown:



3. Press  to flashing and use   keys to select USBVCP or USBTMC function. Press  to select the corresponding settings. When select the USBTMC function then following display will be shown:

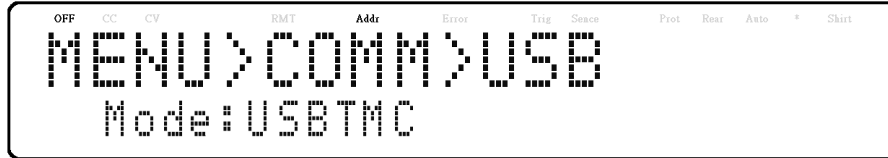

4.1.2 USBVCP:



The USBVCP is a virtual COM port that can be used for remote communication. There are no settings in the menu system for USB configuration. To configure the USBVCP settings, refer to the RS232 settings below, as they are the same.

4.1.3 USBTMC:





When USB port select USBTMC-compliant (refer to the USBVCP settings) and can be used for remote communication and control. There are no additional settings in the menu system for USB configuration. The only requirement is that the USBTMC driver be installed. It is included when installing VISA software on the computer. (We recommend using NI-VISA, which can be downloaded at <http://www.ni.com/visa/>).

4.1.4 RS232

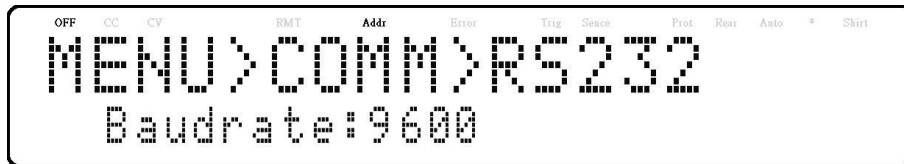
Follow the steps below to configure the power supply for RS232 operation:

1. From the menu, select **Communication** and press .
2. Press  button four times until **RS232** is select, press  to configure the settings for RS232 remote communication. The following display will be shown:



3. Use   keys to select between each serial settings and press  to configure the corresponding settings.
4. To change the baud rate or any of the parameter settings, use the rotary dial.
5. Press  to save each setting and the display will return to the **RS232** menu.
6. Below lists the options that can be changed for each setting:

Baud rates: 9600, 19200, 38400, 57600

Note: The default is 9600, None/8 bits, 1.

* The RS232 interface does not have flow control mechanism. The programmers should be aware of this limitation and notice the command process time of the power supply. If the remote commands

are sent too fast to the power supply, the internal buffer may overrun and cause a communication error.

Therefore, a delay between commands to let the power supply have enough time to process them is mandatory.

All serial settings must match the settings configured on the PC in order for communication to link successfully.

4.1.5 GPIB

Each model can be configured with a GPIB address from 1-30. Follow the instructions below to select and configure the GPIB interface for remote operation.

1. From the menu, select **Communication** and press .
2. When **GPIB** is select, press to configure the settings for GPIB remote communication. The following display will be shown:

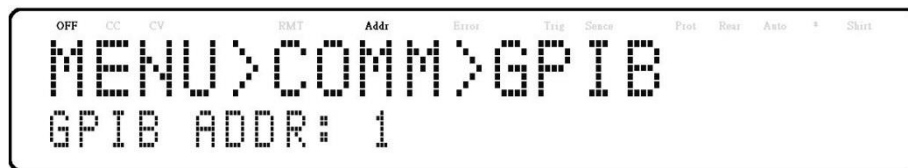

3. Press to configure the GPIB **Address** to which the power supply will be assigned to. Use the rotary dial or numeric keypad to enter a value from 1-30.
4. Press to save each setting and the display will return to the **GPIB** menu.
5. Make sure the address assigned in the power supply unit matches the address the data commands are being sent to.

4.1.6 RS485

The MR series supports multiple power supplies (of the same model, up to *50) that can be connected together via RS485 and be controlled with a computer via USB (virtual COM) interface (Chain mode). If connecting more than 10 units, add a 120Ω resistor terminator to the last unit as shown in the figure [below](#). Follow the instructions below to select and configure the RS485 interface for remote operation.

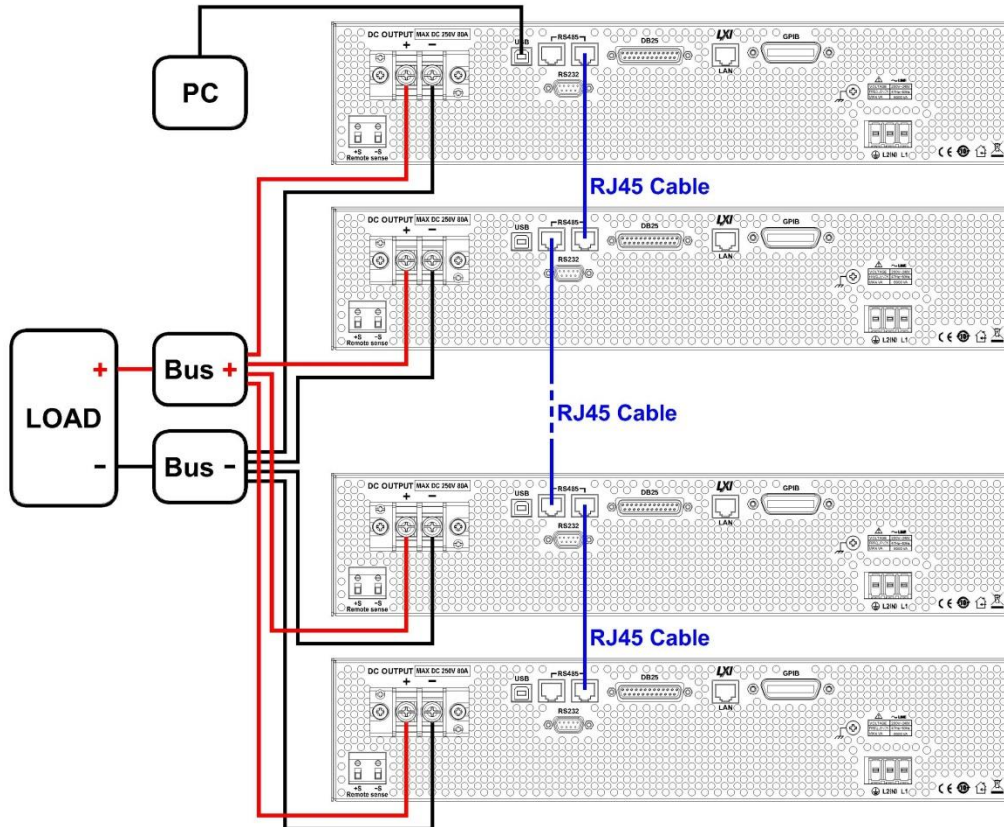
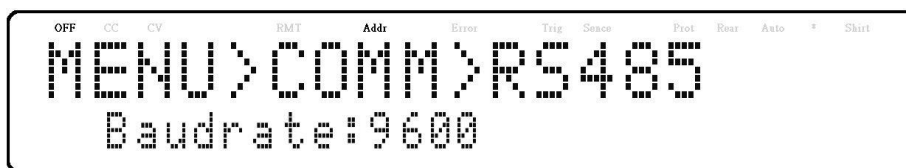



Figure 4.1 – RS485 Connection Diagram for 10+ Units

4. From the menu, browse and select Communication and press **Enter**.
5. Press **▶** button two times until RS485 is select and press **Enter** to configure the settings for RS485 remote communication. The following display will be shown:



6. Use **◀▶** keys to select between each settings and press **▶** to configure the corresponding setting.
7. To change the parameter settings, use the rotary dial or **◀▶** keys.

8. Press  to save each setting and the display will return to the RS485 menu.
9. Below lists the options that can be changed for each setting:
10. Baud rate: 9600, 19200, 38400, 57600
11. Note: The default is 9600, None/8 bits, 1, Address = 1, Off.
12. For each power supply that you want to control, provide a different address. For example, if you have three power supplies to control, set the first supply to address 1, second supply to address 2, and third supply to address 3. If two or more supplies have the same address, the RS485 protocols will create communication errors.
13. Repeat the above steps for each power supply that you want to connect together and control, making sure that each of them have a different address assigned.
14. Connect the USB of the first supply (address 1) to the computer, then use the Multi-Unit Programming commands to communicate with each power supply. Refer to "[4.7 Multi-Unit Programming Commands](#)".



⚠ CAUTION

When connecting multiple power supplies (of the same model) in parallel while in chain mode, there will be a decrease in speed and performance with each additional units connected in parallel. The voltage and current scan speed, which affects the synchronization between the power supplies, between the slave units and the master unit will increase based on the following formula: $250 * N$ (in milliseconds) where N is the number of power supplies (of the same model) in parallel. Please note as more power supplies are paralleled and linked together, speed will become slower. Thus, we do not recommend paralleling more than 4 power supplies while in chain mode to ensure fast performance. Parallel mode is recommended when the application requires paralleling 5 to 10 power supplies. Refer to section 3.6 Parallel Operation for more details.





4.1.7 LAN (Ethernet)

The LAN interface supports Telnet connection and Socket connection. It also can be used to connect with the built-in web server GUI.

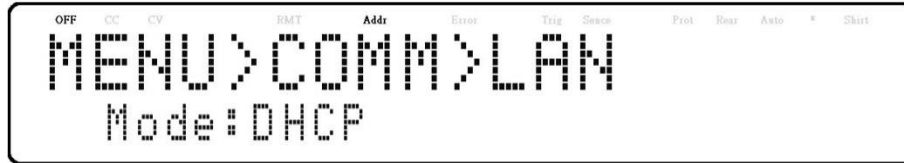
Follow the instructions below to select Ethernet interface for remote operation.

1. From the menu, select **Communication** and press .
2. Press  button two times until **LAN** is select and press  to configure the settings for LAN remote communication. The following display will be shown:



3. Use   keys to select between each settings and press  to configure the corresponding setting.
4. To change any of the parameter settings, use the rotary dial.
5. Press  to save each setting and the display will return to the **LAN** menu.
6. The following lists the options that can be changed for each setting:

Mode: DHCP, MANUAL

IP Addr: 000.000.000.000

Subnet: 000.000.000.000

Gateway: 000.000.000.000

DNS: 000.000.000.000

4.1.8 Web server

There is an embedded web server GUI that can access the power supply via LAN interface using a web browser. The GUI provides a simple way of setting voltage and current, as well as monitoring the output, using a web browser from a computer connected to the same local area network as the power supply. To access this, do the following:

1. Connect the power supply to the same network as the PC.
2. Open a web browser on the computer to control the power supply.
3. Check the IP address of the power supply through INFO in the MENU.
4. Type the IP address of the power supply in the URL bar of your browser with http:// prefix (i.e. http://192.168.1.55 for IP Address 192.168.1.55).
5. If correctly configured, the screen will be shown Home page, and enter the Lan Config page, Config page, and Control page turn into Web Server Login Page, the following screen will be shown:

DC Source Web Login Page

Please enter password to continue

PASSWORD :

Figure 4.2 – Web Server Login Page

- A password is required to login and access the menu items on the page. The default admin password **123456**.

The web server menu items are described below:

4.1.8.1 HOME page

The HOME page provides general information of the power supply: LXI Device Model, Manufacturer, Serial Number, Description, LXI Version, mDNS Hostname, MAC address, TCP/IP address, Firmware Version, LXI Extended Function, LXI Device Address String, TCP/IP SOCKET Device Address String, USBTMC Device Address String, GPIB Device Address String, USB Port Function, RS232C setting, RS485 setting, Identification indicator function.

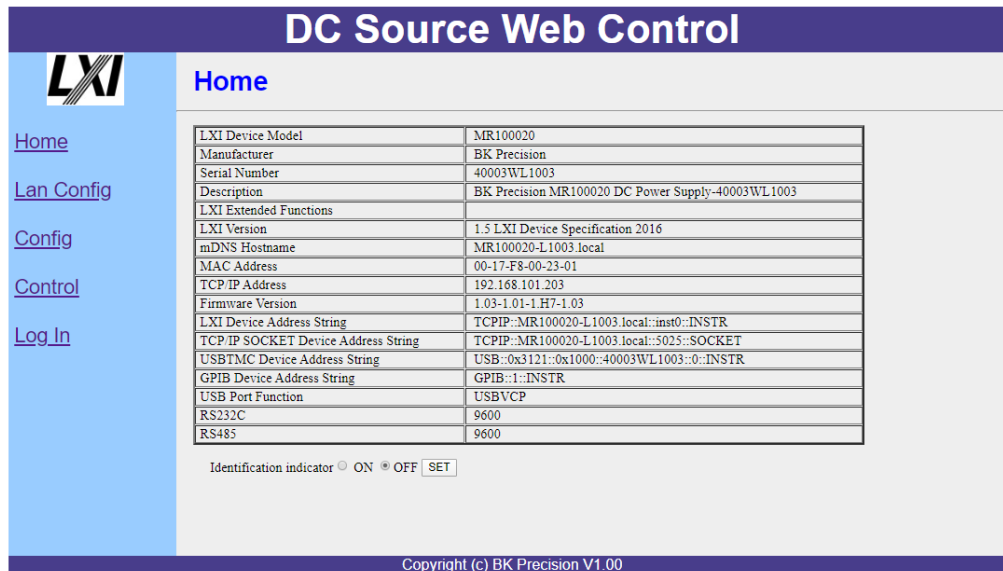

The screenshot shows the 'DC Source Web Control' interface. On the left is a navigation menu with links for Home, Lan Config, Config, Control, and Log In. The main content area is titled 'Home' and contains a table of device information. At the bottom of the table is a control for the 'Identification indicator' with radio buttons for 'ON' and 'OFF', and a 'SET' button. The footer of the page reads 'Copyright (c) BK Precision V1.00'.

LXI Device Model	MR100020
Manufacturer	BK Precision
Serial Number	40003WL1003
Description	BK Precision MR100020 DC Power Supply-40003WL1003
LXI Extended Functions	
LXI Version	1.5 LXI Device Specification 2016
mDNS Hostname	MR100020-L1003.local
MAC Address	00-17-F8-00-23-01
TCP/IP Address	192.168.101.203
Firmware Version	1.03-1.01-1.H7-1.03
LXI Device Address String	TCPIP::MR100020-L1003.local::inst0::INSTR
TCP/IP SOCKET Device Address String	TCPIP::MR100020-L1003.local::5025::SOCKET
USBTMC Device Address String	USB::0x3121::0x1000::40003WL1003::0::INSTR
GPIB Device Address String	GPIB::1::INSTR
USB Port Function	USBVCP
RS232C	9600
RS485	9600

Identification indicator ON OFF

Figure 4.3 – Web Server Home Page

4.1.8.2 LAN CONFIG page

The LAN CONFIG page provides the Hostname, Description, IP Address, IP Address, Netmask, Gateway, DNS, password, Lan configuration, initialize, Restore Factory Settings.

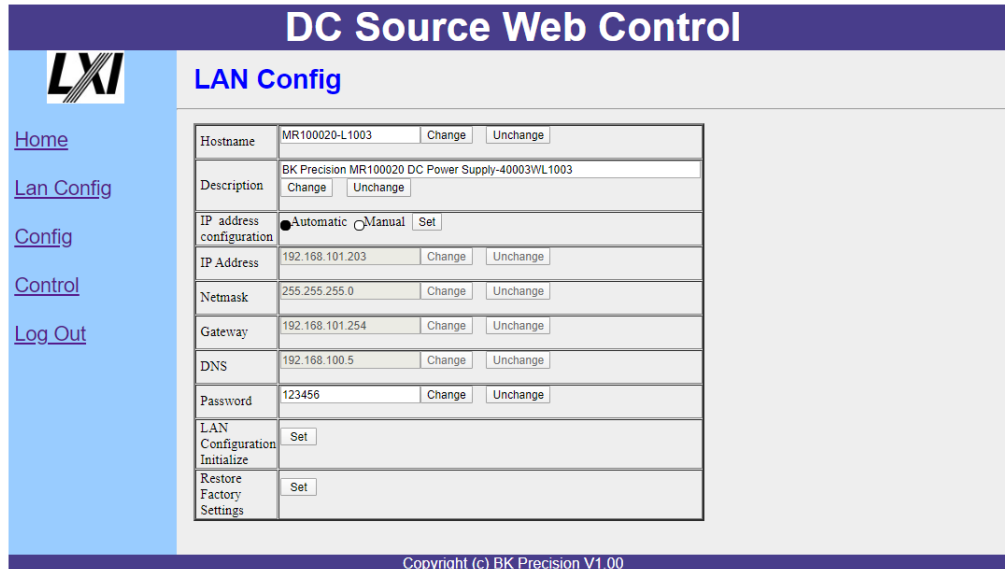

Figure 4.4 – Web Server LAN Configuration Page

4.1.8.3 CONFIG page

The CONFIG page provides the protection settings (OVP, OCP, OPP, CV to CC, and CC to CV) and output related parameters such as voltage/current slope and limit settings.

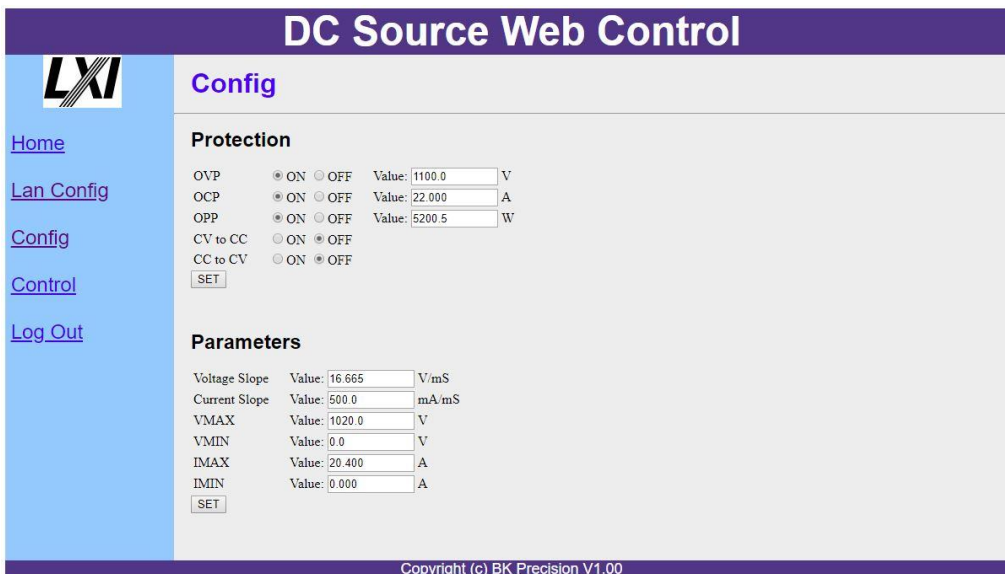

Figure 4.5 – Web Server Configuration Page

4.1.8.4 CONTROL page

The CONTROL page provides the general control of the power supply such as output On/Off setting as well as the voltage and current setting. The command line for SCPI commands can also be accessed here.

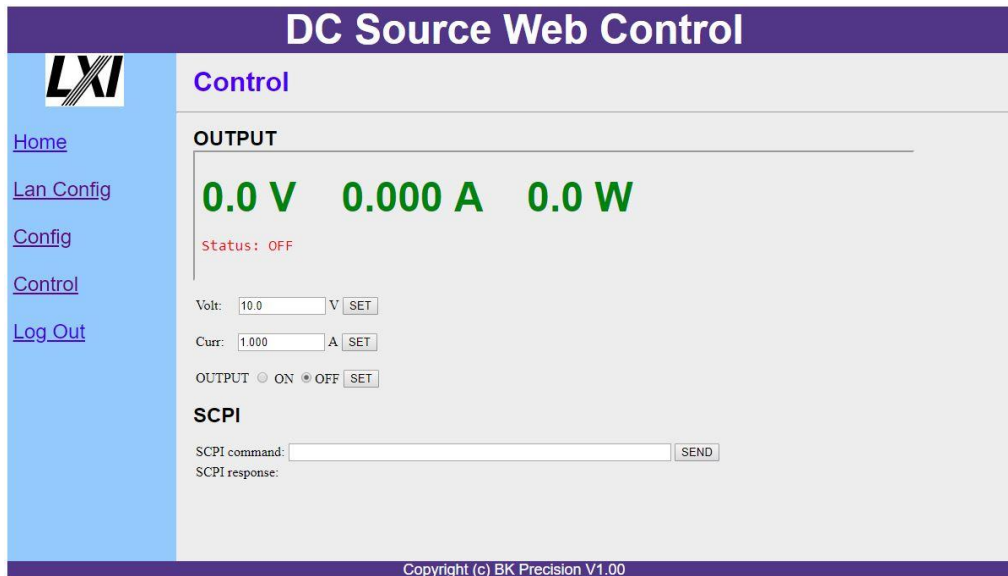

Figure 4.6 – Web Server Control Page

The Log Out will exit the web page and go back to Home page.

4.1.8.5 Socket connection

Socket connection is available for communication via LAN (Ethernet) interface. The instrument uses the TCP/IP protocol for communication. Users can use socket port **5025** to open a raw socket connection for sending remote commands.

4.2 Error/Event List

SCPI interface can offer an error/event list that contains up to 20 errors/events. Users can read the errors/events through the

“SYStem:ERRor?” query command in a first-in first-out manner. Once an error/event is read, the read process will clear it from the memory. To clear all errors/events from the memory, the “*CLS” command can be used.

The following table lists all the known errors that can be encountered.

Error	Description
-000	No error
-102	Syntax error
-103	Invalid separator
-104	Data type error
-105	GET not allowed
-108	Parameter not allowed

-109	Missing Parameter
-110	Command header error
-111	Header separator error
-113	Undefined header
-131	Invalid suffix
-138	Suffix not allowed
-200	Execution error
-203	Command protected
-221	Settings conflict
-222	Data out of range
-223	Too much data
-240	Hardware error
-350	Error queue overflow

5 Calibration



B&K Precision recommends a calibration interval of one year to ensure that the power supply meets specifications. This instrument features closed-case calibration. To perform the calibration, the following equipment is required:

- 5 ½ digit digital multimeter (DMM); B&K Precision 5491B or equivalent

⚠ WARNING

The following calibration instructions may be used by authorized technicians or calibration personnel only. If you are not authorized, do not attempt to calibrate the instrument yourself, as it may damage the instrument and void the warranty.

To enter the calibration procedure, follow the steps below:

1. Press the **Menu** button and press the  button until SYSTEM is selected and press **Enter**. Keep pressing the  button until CALIBRATION is selected and press **Enter**.

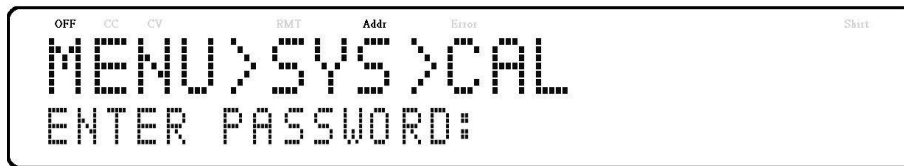

2. Enter the password **13579**, using the numeric keypad, and press the **Enter** key to confirm. The following display will be shown:

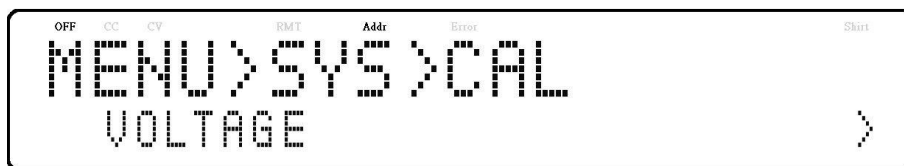

Below is a list of calibration options:

- VOLTAGE
- CURRENT
- OVP
- OCP
- EXT VOLTAGE
- EXT CURRENT
- EXT VOLTAGE CC
- EXT CURRENT CC

- FACTORY CAL. DATA RESTORE

These options are only accessible in the calibration menu. The following calibration procedures assume the operator is in the CAL menu.

5.1 Voltage Calibration

Follow the steps below to perform the voltage calibration:

1. Connect the DMM to the output of the power supply as shown in the figure below:

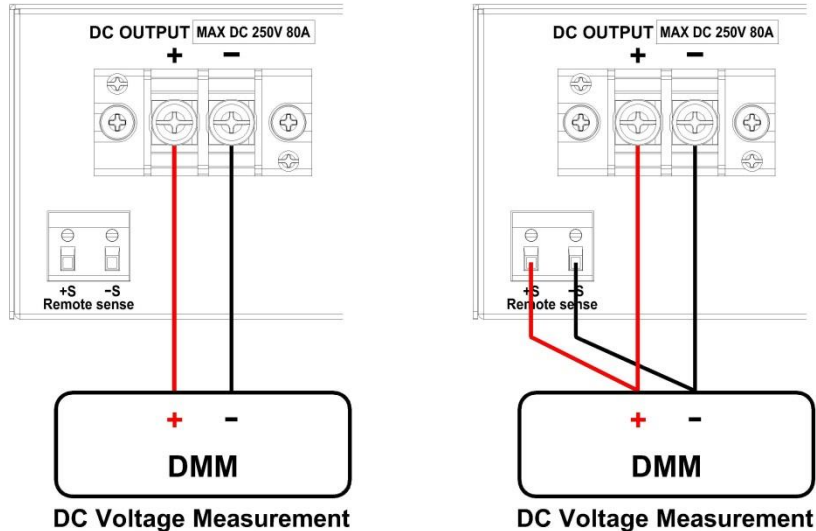
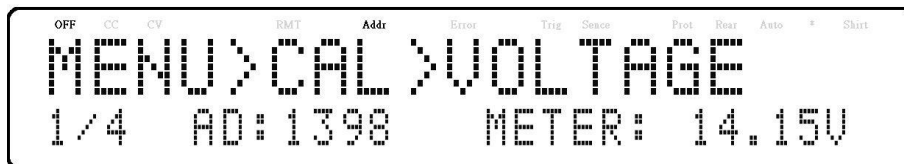

Figure 5.1 – Voltage Calibration Diagram

When only calibrate local sense, connect the DMM to the output. When need to calibrate remote sense, connect the DMM to the output and remote sense.

2. Set the DMM to a DC voltage measurement. Select the **VOLTAGE** parameter in the **Calibration** menu and press **Enter**. The following will be displayed:



The 1/4 signifies there are 4 points to be calibrated, and the current calibration point is 1, and press **On/Off** to start calibration.

3. When METER parameter is blinking, input the voltage reading from the DMM in the **METER** parameter by using the numeric keypad and press **Enter**.
4. Repeat this procedure by entering the meter readings for points 2 – 4.

5.2 Current Calibration

Follow the steps below to perform the current calibration:

1. Connect the shunt resistance, DMM and Electronic load to the output of the power supply as shown in the figure below:

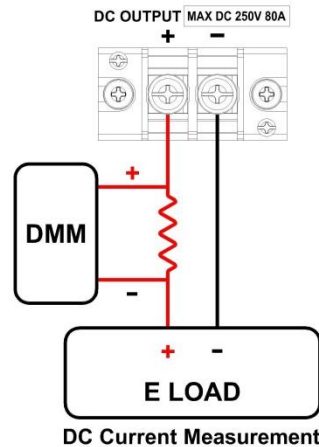
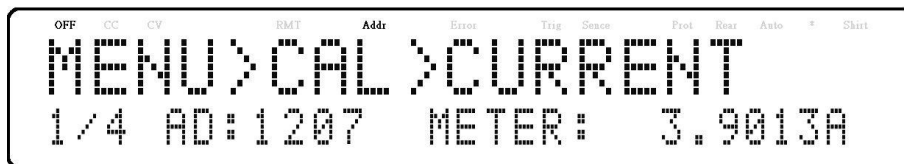

Figure 5.2 – Current Calibration Diagram

2. Set the DMM to a DC voltage measurement. Set the Electric Load in CV mode, the voltage set 5V. Select the **CURRENT** parameter in the **Calibration** menu and press . The following will be displayed:



The 1/4 signifies there are 4 points to be calibrated, and the current calibration point is 1, and press to start calibration.

3. When METER parameter is blinking, input the current, that voltage reading from the DMM divided by the shunt resistance, in the METER parameter by using the numeric keypad .
4. Repeat this procedure by entering the meter readings for points 2 – 4.

5.3 OVP Calibration

The overvoltage protection (OVP) calibration can be executed right after the voltage calibration or the user can select OVP in the Calibration menu.

Follow the steps below to perform the overvoltage protection calibration:

1. Disconnect any load from the output terminal of the power supply.

2. Select the **OVP** parameter in the **CAL** menu and press **Enter**. The following will be displayed:

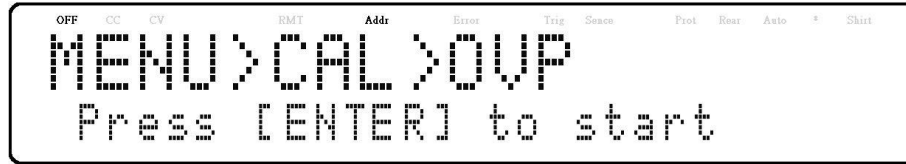

3. Press **Enter** to run the OVP calibration or press **Esc** to abort. The OVP calibration is an automatic process that will take about 10 to 20 seconds.
4. After the calibration is finished, the following message will be displayed:

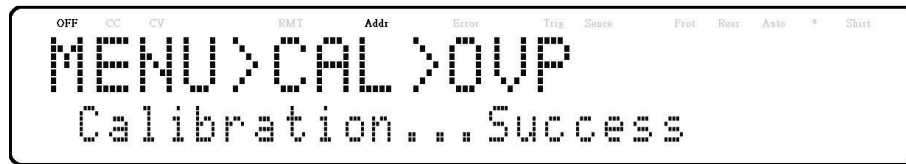

5.4 OCP Calibration

The overcurrent protection (OCP) can be executed right after the current calibration or the user can select **OCP** in the **Calibration** menu.

Follow the steps below to perform the voltage calibration:

1. Short the output + and - terminals of the power supply as shown below:

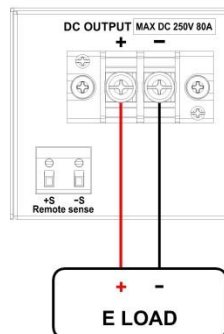
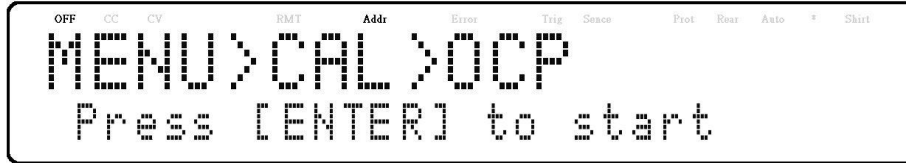
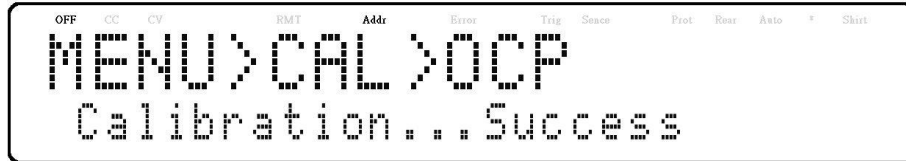

Figure 5.3 – OCP Calibration Diagram

2. Set the Electric Load in CV mode, the voltage set 5V. Select the **OCP** parameter in the **CAL** menu and press **Enter**. The following will be displayed:



3. Press **Enter** to run the OCP calibration or press **Esc** to abort. The OCP calibration is an automatic process that will take about 20 to 30 seconds.
4. After the calibration is finished, the following message will be displayed:



5.5 External Voltage Programming Calibration

Follow the steps below to perform the external voltage programming calibration:

1. Connect the DMM to the external analog control terminals of DB25 connector (+ on the DMM to Pins 9 and 11, - on the DMM to Pin 22 (GND)) on the rear of the power supply, as shown in the figure below:

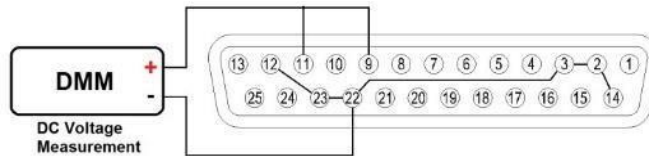
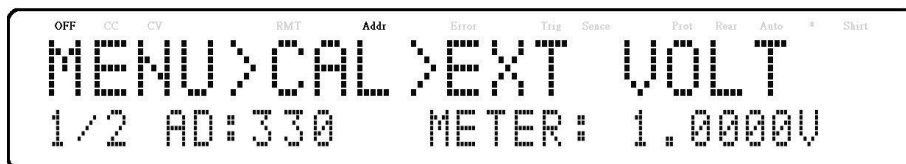

Figure 5.4 – External Voltage Programming Calibration Diagram

2. Set the DMM to a DC voltage measurement. Select the **EXT VOLTAGE** parameter in the **Calibration** menu and press **Enter**. The following will be displayed:



The *P: 1/2* signifies there are 2 points to be calibrated and the current calibration point is 1.

1. Input the voltage reading from the DMM in the **METER** parameter by using the numeric keypad and press **Enter**.
2. Repeat this procedure by entering the meter readings for points 2.

5.6 External Current Programming Calibration

Follow the steps below to perform the external current programming calibration:

1. Connect the DMM to the external analog control terminals of DB25 connector (+ on the DMM to Pins 10 and 24, - on the DMM to Pin 22 (GND)) on the rear of the power supply, as shown in the figure below:

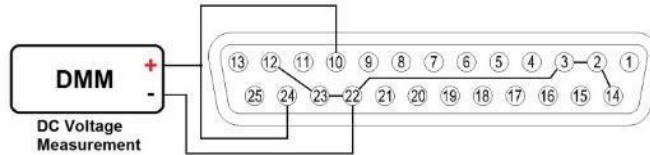
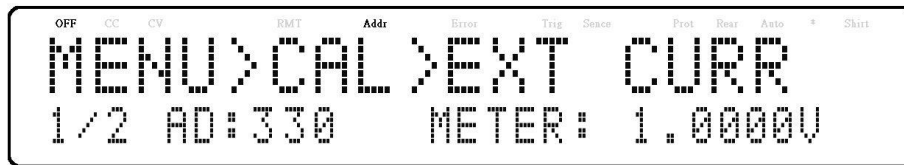

Figure 5.5 – External Current Programming Calibration Diagram

2. Set the DMM to a DC voltage measurement. Select the **EXT CURRENT** parameter in the **CAL** menu and press **Enter**. The following will be displayed:



The P: 1/2 signifies there are 2 points to be calibrated and the current calibration point is 1.

3. Input the voltage reading from the DMM in the **METER** parameter by using the numeric keypad and press **Enter**.
4. Repeat this procedure by entering the meter readings for points 2.

5.7 CC Calibration of External Voltage

Follow the steps below to perform the calibration procedure for the constant current source of the external voltage programming by resistor mode:

1. Connect the external analog control terminals of DB25 connector (Pins 9, 22 (GND)) on the rear of the power supply, as shown in the figure below:

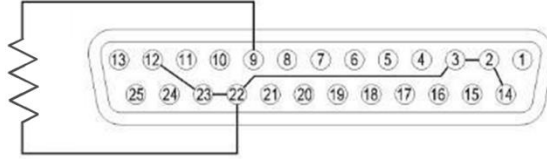

Figure 5.6 – CC Calibration of External Voltage Diagram

2. Select the **EXT VOLTAGE CC** parameter in the **Calibration** menu and press **Enter**. The following will be displayed:

```

OFF  CC  CV  RMT  Addr  Error  Shift
MENU>SYS>CAL>EXTVCC
1/4 AD:8

```

The *P: 1/4* signifies there are 4 points to be calibrated and the current calibration point is 1.

The four points use 0Ω, 2.5kΩ, 7.5kΩ, 10kΩ.

3. Press **On/Off**, the calibration will start, if the resistor is not insert or not correct, the following will be displayed:

```

OFF  CC  CV  RMT  Addr  Error  Shift
MENU>SYS>CAL>EXTVCC
1/4 AD:3901 Insert Resistor !

```

4. If the resistor is correct, the following will be displayed, press **Enter**.

```

OFF  CC  CV  RMT  Addr  Error  Shift
MENU>SYS>CAL>EXTVCC
1/4 AD:10      Press [ENTER]

```

5. Repeat this procedure by entering the meter readings for points 2 – 4.

5.8 CC Calibration of External Current

Follow the steps below to perform the calibration procedure for the constant current source of the external current programming by resistor mode:

1. Connect the external analog control terminals of DB25 connector (Pins 10, Pin 22 (GND)) on the rear of the power supply, as shown in the figure below:

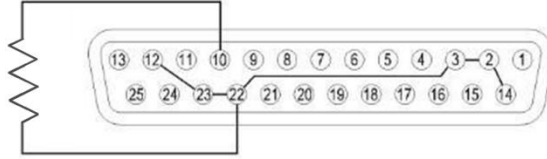

Figure 5.7 – CC Calibration of External Current Diagram

2. Select the **EXT CURRENT CC** parameter in the **Calibration** menu and press **Enter**. The following will be displayed:

```

OFF  CC  CV      RMT  Addr  Error  Shift
MENU>SYS>CAL>EXTICC
1/4 AD:3901
  
```

The *P: 1/4* signifies there are 4 points to be calibrated and the current calibration point is 1.

The four points use 0Ω, 2.5kΩ, 7.5kΩ, 10kΩ.

6. Press **On/Off**, the calibration will start, if the resistor is not insert or not correct, the following will be displayed:

```

OFF  CC  CV      RMT  Addr  Error  Shift
MENU>SYS>CAL>EXTICC
1/4 AD:3901 Insert Resistor !
  
```

7. If the resistor is correct, the following will be displayed, press **Enter**.

```

OFF  CC  CV      RMT  Addr  Error  Shift
MENU>SYS>CAL>EXTICC
1/4 AD:10      Press [ENTER]
  
```

8. Repeat this procedure by entering the meter readings for points 2 – 4.

6 Troubleshooting Guide

Below are some frequently asked questions and answers. Please check if any apply to your power supply before contacting B&K Precision.

6.1 General

Q: I cannot power up the power supply.

Check that the power cord is securely connected to the AC input and there is live power from your electrical AC outlet.

Verify that the AC power coming from the mains contains the correct voltage. The power supply can accept a specific range of AC input voltages. Refer to section [2.1](#).

Q: How do I set up the supply to run in constant current mode?

The supply is a CV/CC power supply that automatically crosses over from CV to CC upon a load which draws current at the current limit (ISET). Therefore, it is dependent on the load. For example, if ISET is configured as 1 A, the load must draw 1 A before the supply will go into CC mode.

Q: How come my display voltage is lower than the voltage I set?

This is often because of the resistances from the test leads/wires connected between the supply and the DUT (device under test), which causes a drop in voltage. To minimize this drop, use remote sense terminals to compensate and output a more accurate voltage to the DUT.

Q: I cannot set voltage at the maximum rating.

This may be that the set voltage is outside of the voltage maximum limit. Refer to section 3.6 under "[Output Limit Settings](#)" to verify and configure the limits.

Remote Control

Q: I am trying to send the commands over USB/RS232, but it does not seem to respond.

Check that you are sending ASCII strings that are terminated with a CR (carriage return) and LF (linefeed) character.

For RS232 and RS485, check that the baud rate, parity, data bits, stop bit, and flow control settings match with the settings configured on the software interface.

For RS485, check that the wires are correctly daisy chained between multiple units.

To ensure the most current version of this manual, please download the latest version here:

For current up-to-date product information, please visit

www.bkprecision.com

Specifications

Note: All specifications apply to the unit after a temperature stabilization time of 15 minutes over an ambient temperature range of 23 °C ± 5 °C. Specifications are valid for single unit operation only.

Model	MR25080	MR50040	MR100020	
Output Rating				
Output Voltage	0 to 250 V	0 to 500 V	0 to 1000 V	
Output Current	0 to 80 A	0 to 40 A	0 to 20 A	
Output Power	5000 W			
Line Regulation				
Voltage	15 mV	55 mV	80 mV	
Current	20 mA	12 mA	10 mA	
Load Regulation				
Voltage	120 mV	200 mV	250 mV	
Current	50 mA	40 mA	25 mA	
Ripple and Noise (20 Hz to 20 MHz)				
Voltage p-p	500 mV	600 mV	700 mV	
Voltage rms	85 mV	75 mV	120 mV	
Current rms ⁽¹⁾	20 mA	10 mA	5 mA	
Resolution				
Programming	10 mV / 5 mA	20 mV / 2 mA	100 mV / 1 mA	
Readback	10 mV / 5 mA	20 mV / 2 mA	100 mV / 1 mA	
Programming Accuracy				
Voltage	100 mV	300 mV	500 mV	
Current	60 mA	50 mA	25 mA	
Readback Accuracy				
Voltage	250 mV	300 mV	500 mV	
Current	60 mA	50 mA	25 mA	
Output Response Time⁽²⁾				
Rising Time	Full Load	≤ 30 ms	≤ 30 ms	≤ 30 ms
	No Load	≤ 30 ms	≤ 30 ms	≤ 30 ms
Falling Time	Full Load	≤ 55 ms	≤ 40 ms	≤ 50 ms
	No Load	≤ 8 s	≤ 10 s	≤ 10 s
Protection				
OVP	Range	0 to 275 V	0 to 550 V	0 to 1100 V
	Accuracy	2.5 V	5 V	10 V
OCP	Range	0 to 96 A	0 to 48 A	0 to 24 A
	Accuracy	0.8 A	0.4 A	0.2 A

(1) Current ripple is applied when output power > 1.0% of full power.

(2) From 10% to 90% or from 90% to 10% of total voltage excursion.

General				
Remote Sense Compensation	5 V	10 V	20 V	
Transient Response Time ⁽³⁾	≤ 1.5 ms	≤ 1.5 ms	≤ 1.5 ms	
Command Response Time ⁽⁴⁾	10 ms	10 ms	10 ms	
Efficiency ⁽⁵⁾	≥ 85%			
Power Factor	0.99			
I/O Interfaces	Analog (Galvanically isolated DB25), USB (USBTMC-compliant and virtual COM), RS232, GPIB, LAN (1.5 LXI device specification 2016)			
AC Line Input	200 to 240 VAC ± 10%, 47 Hz to 63 Hz			
AC Line Phase	Single phase			
Maximum Rated Input Power	6000 VA			
Temperature Ratings	Operation	32 °F to 104 °F (0 °C to 40 °C)		
	Storage	-40 °F to 185 °F (-40 °C to 85 °C)		
Temperature Coefficient	Voltage	50 mV / °C	100 mV / °C	200 mV / °C
	Current	32 mA / °C	16 mA / °C	8 mA / °C
Dimensions (W×H×D)	16.5" x 3.5" x 21" (420 x 88 x 532 mm)			
Weight	38.6 lbs (17.5 kg)			
Warranty	3 Years			
Standard Accessories	Power cord, test report & certificate of calibration			
Optional Accessories	Rack mount kit (RKPVS)			

Regulatory Compliance	
Safety	Low Voltage Directive (LVD) 2014/35/EU, EN61010-1:2010, cTUVus certification mark ⁽⁶⁾ fulfills US (UL 61010-1:2012) and Canadian (CAN/CSA-C22.2 NO. 61010-1-12) safety standards
Electromagnetic Compatibility	EMC Directive 2014/30/EU, EN61326-1:2013

(3) Time for output voltage to recover within 1.5% of its rated output for a load change 50-100% of rated output current.

(4) Typical time required for output to begin to change following receipt of command data.

(5) At nominal line and max load.

(6) Tested and certified by a Nationally Recognized Testing Laboratory (NRTL), accredited by OSHA.

7 SERVICE INFORMATION

Warranty Service:

Please go to the support and service section on our website at www.bkprecision.com to obtain a RMA#. Return the product in the original packaging with proof of purchase to the address below. Clearly state on the RMA the performance problem and return any leads, probes, connectors and accessories that you are using with the device.

Non-Warranty Service:

Please go to the support and service section on our website at www.bkprecision.com to obtain a RMA#. Return the product in the original packaging to the address below. Clearly state on the RMA the performance problem and return any leads, probes, connectors and accessories that you are using with the device. Customers not on an open account must include payment in the form of a money order or credit card. For the most current repair charges please refer to the service and support section on our website.

Return all merchandise to B&K Precision Corp. with prepaid shipping. The flat-rate repair charge for Non-Warranty Service does not include return shipping. Return shipping to locations in

North America is included for Warranty Service. For overnight shipments and non-North American shipping fees please contact B&K Precision Corp.

B&K Precision Corp.

22820 Savi Ranch Parkway Yorba Linda, CA 92887

www.bkprecision.com 714-921-9095

Include with the returned instrument your complete return shipping address, contact name, phone number and description of problem.

LIMITED THREE YEAR WARRANTY

B&K Precision Corp. warrants to the original purchaser that its products and the component parts thereof, will be free from defects in workmanship and materials for a period of **three years** from date of purchase.

B&K Precision Corp. will, without charge, repair or replace, at its option, defective product or component parts. Returned product must be accompanied by proof of the purchase date in the form of a sales receipt.

To help us better serve you, please complete the warranty registration for your new instrument via our website www.bkprecision.com

Exclusions: This warranty does not apply in the event of misuse or abuse of the product or as a result of unauthorized alterations or repairs. The warranty is void if the serial number is altered, defaced or removed.

B&K Precision Corp. shall not be liable for any consequential damages, including without limitation damages resulting from loss of use. Some states do not allow limitations of incidental or consequential damages. So the above limitation or exclusion may not apply to you. This warranty gives you specific rights and you may have other rights, which vary from state-to- state.

B&K Precision Corp.

22820 Savi Ranch Parkway Yorba Linda, CA 92887

www.bkprecision.com 714-921-9095



22820 Savi Ranch Parkway Yorba Linda, CA 92887

www.bkprecision.com

© 2018 - 2019 B&K Precision Corp.

V03172020