

Surface-Mount Glass Passivated Rectifier

SMC (DO-214AB)

RoHS
 COMPLIANT
 HALOGEN
FREE

FEATURES

- Low profile package
- Ideal for automated placement
- Glass passivated pellet chip junction
- Low forward voltage drop
- Low leakage current
- High forward surge capability
- Meets MSL level 1, per J-STD-020, LF maximum peak of 260 °C
- AEC-Q101 qualified available
 - Automotive ordering code: base P/NHM3
- Material categorization: for definitions of compliance please see www.vishay.com/doc?99912

TYPICAL APPLICATIONS

For use in general purpose rectification of power supplies, inverters, converters, and freewheeling diodes for consumer, automotive, and telecommunication.

MECHANICAL DATA

Case: SMC (DO-214AB)

Molding compound meets UL 94 V-0 flammability rating

Base P/N-M3 - halogen-free, RoHS-compliant

Base P/NHM3 - halogen-free, RoHS-compliant, and AEC-Q101 qualified

Terminals: Matte tin plated leads, solderable per J-STD-002 and JESD 22-B102

M3 and HM3 suffix meets JESD 201 class 2 whisker test

Polarity: Color band denotes cathode end

PRIMARY CHARACTERISTICS	
$I_{F(AV)}$	8.0 A
V_{RRM}	400 V, 600 V, 800 V, 1000 V
I_{FSM}	200 A
I_R	10 μ A
V_F at $I_F = 8$ A ($T_A = 125$ °C)	0.87 V
T_J max.	150 °C
Package	SMC (DO-214AB)
Diode variations	Single

MAXIMUM RATINGS ($T_A = 25$ °C unless otherwise noted)						
PARAMETER	SYMBOL	S8CG	S8CJ	S8CK	S8CM	UNIT
Device marking code		8G	8J	8K	8M	
Maximum repetitive peak reverse voltage	V_{RRM}	400	600	800	1000	V
Maximum RMS voltage	V_{RMS}	280	420	560	700	V
Maximum DC blocking voltage	V_{DC}	400	600	800	1000	V
Maximum average forward rectified current	$I_{F(AV)}$ ⁽¹⁾	8.0				A
	$I_{F(AV)}$ ⁽²⁾	1.6				A
Peak forward surge current 8.3 ms single half sine-wave superimposed on rated load	I_{FSM}	200				A
Operating junction and storage temperature range	T_J, T_{STG}	-55 to +150				°C

Notes

⁽¹⁾ Mounted on aluminum PCB 30 mm x 30 mm with aluminum heatsink

⁽²⁾ Free air, mounted on recommended copper pad area



ELECTRICAL CHARACTERISTICS ($T_A = 25\text{ }^\circ\text{C}$ unless otherwise noted)						
PARAMETER	TEST CONDITIONS		SYMBOL	TYP.	MAX.	UNIT
Instantaneous forward voltage	$I_F = 4.0\text{ A}$	$T_A = 25\text{ }^\circ\text{C}$	$V_F^{(1)}$	0.89	-	V
	$I_F = 8.0\text{ A}$			0.96	0.985	
	$I_F = 4.0\text{ A}$	$T_A = 125\text{ }^\circ\text{C}$		0.78	-	
	$I_F = 8.0\text{ A}$			0.87	0.935	
Reverse current	Rated V_R	$T_A = 25\text{ }^\circ\text{C}$	$I_R^{(2)}$	-	10	μA
		$T_A = 125\text{ }^\circ\text{C}$		-	350	
Typical reverse recovery time	$I_F = 0.5\text{ A}, I_R = 1.0\text{ A}, I_{rr} = 0.25\text{ A}$		t_{rr}	4	-	μs
Typical junction capacitance	4.0 V, 1 MHz		C_J	79	-	pF

Notes

- (1) Pulse test: 300 μs pulse width; 1 % duty cycle
- (2) Pulse test: pulse width $\leq 40\text{ ms}$

THERMAL CHARACTERISTICS ($T_A = 25\text{ }^\circ\text{C}$ unless otherwise noted)						
PARAMETER	SYMBOL	S8CG	S8CJ	S8CK	S8CM	UNIT
Typical thermal resistance	$R_{\theta JA}^{(1)}$	75				$^\circ\text{C/W}$
	$R_{\theta JM}^{(2)}$	9.5				

Notes

- (1) Free air, mounted on recommended PCB, 2 oz.pad area; thermal resistance $R_{\theta JA}$ - junction to ambient
- (2) Mounted on 30 mm x 30 mm Aluminum PCB, thermal resistance $R_{\theta JM}$ - junction to mount

ORDERING INFORMATION (Example)				
PREFERRED P/N	UNIT WEIGHT (g)	PREFERRED PACKAGE CODE	BASE QUANTITY	DELIVERY MODE
S8CJ-M3/I	0.257	I	3500	13" diameter plastic tape and reel
S8CJHM3/I ⁽¹⁾	0.257	I	3500	13" diameter plastic tape and reel

Note

- (3) AEC-Q101 qualified

RATINGS AND CHARACTERISTICS CURVES ($T_A = 25\text{ }^\circ\text{C}$ unless otherwise noted)

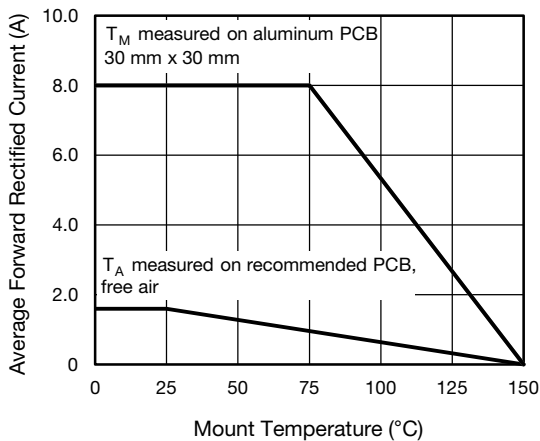

Fig. 1 - Forward Current Derating Curve

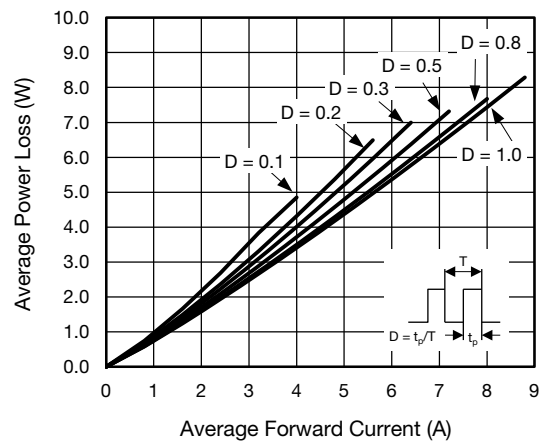

Fig. 2 - Average Power Loss Characteristics

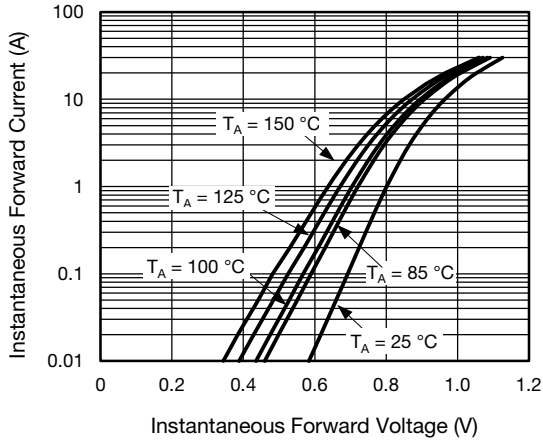

Fig. 3 - Typical Instantaneous Forward Characteristics

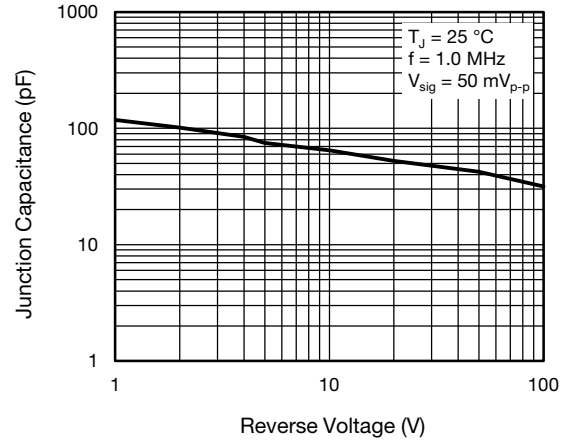

Fig. 5 - Typical Junction Capacitance

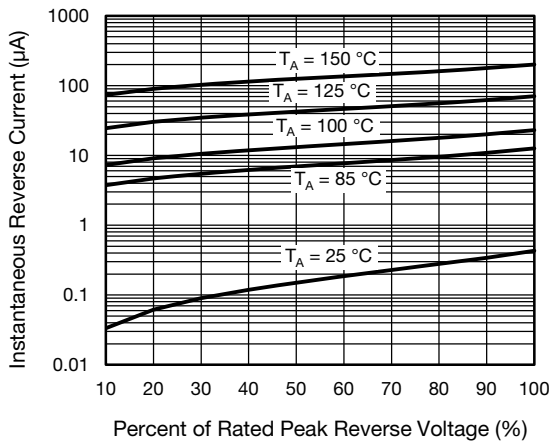

Fig. 4 - Typical Reverse Characteristics

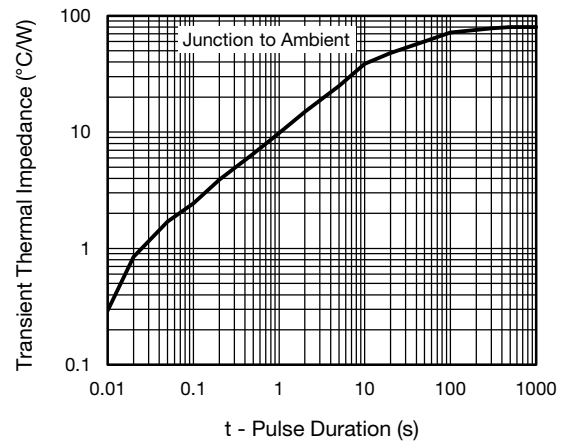
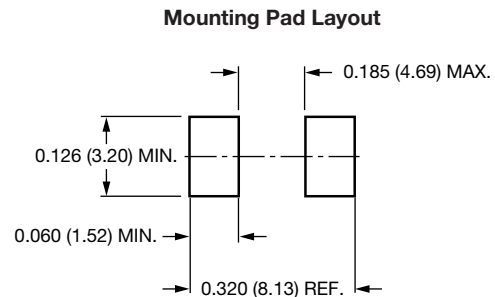
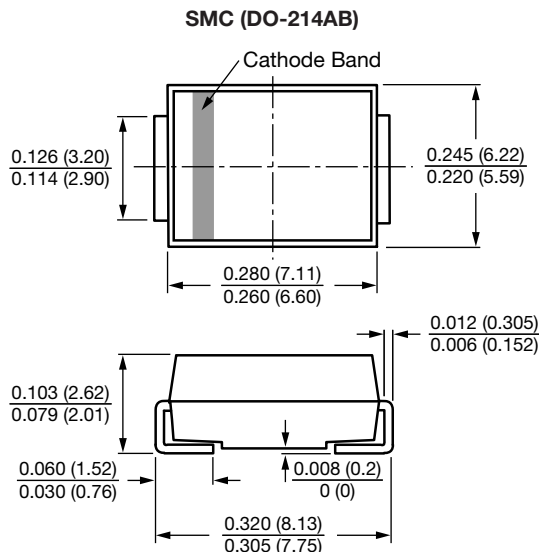

Fig. 6 - Typical Transient Thermal Impedance

PACKAGE OUTLINE DIMENSIONS in inches (millimeters)





Disclaimer

ALL PRODUCT, PRODUCT SPECIFICATIONS AND DATA ARE SUBJECT TO CHANGE WITHOUT NOTICE TO IMPROVE RELIABILITY, FUNCTION OR DESIGN OR OTHERWISE.

Vishay Intertechnology, Inc., its affiliates, agents, and employees, and all persons acting on its or their behalf (collectively, "Vishay"), disclaim any and all liability for any errors, inaccuracies or incompleteness contained in any datasheet or in any other disclosure relating to any product.

Vishay makes no warranty, representation or guarantee regarding the suitability of the products for any particular purpose or the continuing production of any product. To the maximum extent permitted by applicable law, Vishay disclaims (i) any and all liability arising out of the application or use of any product, (ii) any and all liability, including without limitation special, consequential or incidental damages, and (iii) any and all implied warranties, including warranties of fitness for particular purpose, non-infringement and merchantability.

Statements regarding the suitability of products for certain types of applications are based on Vishay's knowledge of typical requirements that are often placed on Vishay products in generic applications. Such statements are not binding statements about the suitability of products for a particular application. It is the customer's responsibility to validate that a particular product with the properties described in the product specification is suitable for use in a particular application. Parameters provided in datasheets and / or specifications may vary in different applications and performance may vary over time. All operating parameters, including typical parameters, must be validated for each customer application by the customer's technical experts. Product specifications do not expand or otherwise modify Vishay's terms and conditions of purchase, including but not limited to the warranty expressed therein.

Except as expressly indicated in writing, Vishay products are not designed for use in medical, life-saving, or life-sustaining applications or for any other application in which the failure of the Vishay product could result in personal injury or death. Customers using or selling Vishay products not expressly indicated for use in such applications do so at their own risk. Please contact authorized Vishay personnel to obtain written terms and conditions regarding products designed for such applications.

No license, express or implied, by estoppel or otherwise, to any intellectual property rights is granted by this document or by any conduct of Vishay. Product names and markings noted herein may be trademarks of their respective owners.

Mouser Electronics

Authorized Distributor

Click to View Pricing, Inventory, Delivery & Lifecycle Information:

[Vishay:](#)

[S8CKHM3/I](#) [S8CJHM3/I](#) [S8CK-M3/I](#) [S8CG-M3/I](#) [S8CGHM3/I](#) [S8CMHM3/I](#) [S8CJ-M3/I](#) [S8CM-M3/I](#)