



Serie 711

Subminiatur Rundsteckverbinder Serie 711 Subminiature circular connectors series 711

Kurzinformation Brief information

- 620
- 702
- 709
- 710
- 711
- 712
- 719
- 423
- 425
- 440
- 581
- 678
- 680
- 682
- 720
- 723
- 623
- 690
- 691
- 692
- 693
- 694
- 707
- 713
- 718
- 733
- 763
- 765
- 768
- 714
- 715
- 766
- 815
- 820
- 825
- 876
- 772
- 775
- A
- B
- C
- R

Kabelsteckverbinder

- Steckverbinder mit Schraubverriegelung
- Schutzart IP 40¹⁾
- Kabeldurchlass in 2 Größen
- Kabelverschraubung mit integrierter Zugentlastung
- Kompatibel zu Steckverbinderreihen 702 und 712

Cable Connector

- Connector with screw locking
- Degree of Protection IP 40¹⁾
- Cable outlet in 2 sizes
- Cable housing with integrated strain relief
- Compatible to series 702 and 712

Aufbau des Steckverbinders:
Construction of the connector:



Maßstab 1 : 1 / Scale 1 : 1

Flanschsteckverbinder

- Steckverbinder werden von hinten in den Montageausschnitt eingesetzt und von vorne verschraubt
- Ausführungen mit Löt- und Tauchlötanschluss
- Gewinkelte und gerade Ausführungen erhältlich

Chassis sockets

- Back mounting into housing and fastened from front side
- Versions with solder and dip-solder contacts
- Angled and straight version available

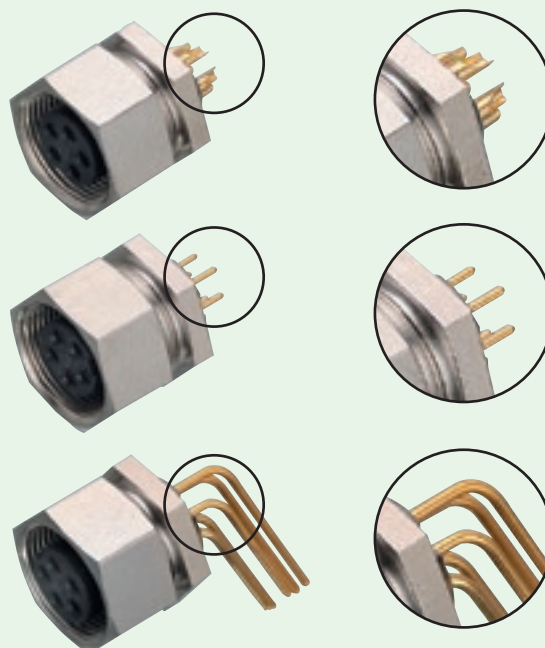

Lötanschluss
Solder termination

Tauchlötanschluss für Leiterplattenlötlung
Dip-solder termination for PCB mounting

Flanschdose mit gewinkelten Kontakten
Female socket with angled contacts



Maßstab 1 : 1 / Scale 1 : 1







¹⁾ Erläuterung der Schutzarten siehe Seite TI-3 – TI-4. / ¹⁾ Explanation of protection standards see page TI-3 – TI-4.



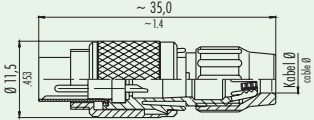

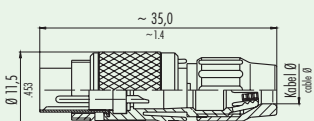

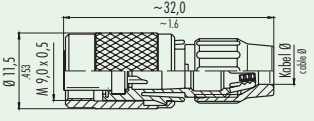

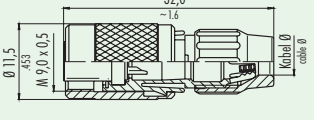

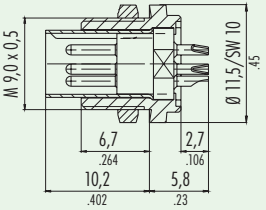
Subminiatur Rundsteckverbinder Serie 711 <i>Subminiature circular connectors series 711</i>		Technische Daten ¹⁾ <i>Specifications ¹⁾</i>					
Allgemeine Kennwerte <i>General Characteristics</i>							
Polzahl	<i>Number of contacts</i>	2	3	4	5	7	8
Verriegelung	<i>Locking system</i>	schrauben / screw					
Anschlussart	<i>Termination</i>	löten, tauchlöten / solder, dip solder					
Anschlussquerschnitt in mm ²	<i>Wire gauge in mm²</i>	max. 0,25				max. 0,14	
Anschlussquerschnitt in AWG	<i>Wire gauge in AWG</i>	max. 24				max. 26	
Kabeldurchlass	<i>Cable outlet</i>	3 - 4 mm / 4 - 5 mm (.12 - .16 in. / .16 - .20 in.)					
Schutzart Gehäuse	<i>Shell protection</i>	IP 40					
Mechanische Lebensdauer	<i>Mechanical operation</i>	> 500 Steckzyklen / > 500 mating cycles					
Obere Grenztemperatur	<i>Upper temperature</i>	+ 85 °C (+ 185 °F)					
Untere Grenztemperatur	<i>Lower temperature</i>	- 40 °C (- 40 °F)					
Gewicht Kabelsteckverbinder	<i>Weight cable connector</i>	~ 5 g					
Gewicht Flanschsteckverbinder	<i>Weight socket</i>	~ 3 g					
Elektrische Kennwerte <i>Electrical Characteristics</i>							
Bemessungsspannung	<i>Rated voltage</i>	125 V					
Bemessungs-Stoßspannung	<i>Rated impulse voltage</i>	1500 V					
Verschmutzungsgrad	<i>Pollution degree</i>	1					
Überspannungskategorie	<i>Overvoltage categorie</i>	II					
Isolierstoffgruppe	<i>Material group</i>	III					
Prüfstoßspannung	<i>Test voltage</i>	1750 V					
Bemessungsstrom (40 °C)	<i>Rated current (40 °C)</i>	4 A	3 A			1 A	
Durchgangswiderstand	<i>Contact resistance</i>	≤ 3 mΩ					
Isolationswiderstand	<i>Insulation resistance</i>	≥ 10 ¹⁰ Ω					
Werkstoffe <i>Materials</i>							
Kontaktstift	<i>Pin contact</i>	CuZn (Messing/brass)					
Kontaktbuchse	<i>Socket contact</i>	CuSn (Bronze/bronze)					
Kontaktoberfläche	<i>Contact plating</i>	Au (Gold/gold)					
Steckerkörper	<i>Male Insert</i>	PBT (UL 94 V-0)					
Buchsenkörper	<i>Female Insert</i>	PA 66 (UL 94 V-0)					
Gehäuse Kabelstecker	<i>Housing cable connector</i>	PA 66 (UL 94 V-0)					
Flanschgehäuse	<i>Socket</i>	CuZn (Messing, vernickelt/brass, nickel plated)					

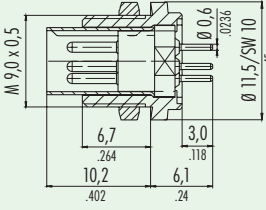
¹⁾ Normen und Prüfbedingungen für diese Angaben siehe Seite TI-16. / ¹⁾ Standards and test parameters for this data see page TI-16.

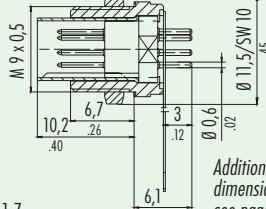
Subminiatur Rundsteckverbinder Serie 711 Subminiature circular connectors series 711

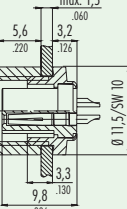
Kabelsteckverbinder Cable connectors

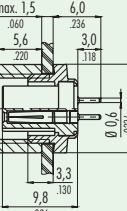
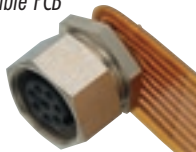
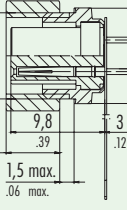
Bezeichnung — Abbildung Description — Figure	Maßzeichnung Drawing	Polzahl Contacts	Bestell-Nr. Ordering-No
Kabelstecker, Kabeldurchlass 3 - 4 mm <i>Male cable connector</i> <i>cable outlet 3 - 4 mm (.12 - .16 in.)</i> 		2	99-0071-100-02
		3	99-0075-100-03
		4	99-0079-100-04
		5	99-0095-100-05
		7	99-0475-100-07
		8	99-0479-100-08
Kabelstecker, Kabeldurchlass 4 - 5 mm <i>Male cable connector</i> <i>cable outlet 4 - 5 mm (.16 - .20 in.)</i> 		2	99-0071-102-02
		3	99-0075-102-03
		4	99-0079-102-04
		5	99-0095-102-05
		7	99-0475-102-07
		8	99-0479-102-08
Kabeldose, Kabeldurchlass 3 - 4 mm <i>Female cable connector</i> <i>cable outlet 3 - 4 mm (.12 - .16 in.)</i> 		2	99-0072-100-02
		3	99-0076-100-03
		4	99-0080-100-04
		5	99-0096-100-05
		7	99-0476-100-07
		8	99-0480-100-08
Kabeldose, Kabeldurchlass 4 - 5 mm <i>Female cable connector</i> <i>cable outlet 4 - 5 mm (.16 - .20 in.)</i> 		2	99-0072-102-02
		3	99-0076-102-03
		4	99-0080-102-04
		5	99-0096-102-05
		7	99-0476-102-07
		8	99-0480-102-08

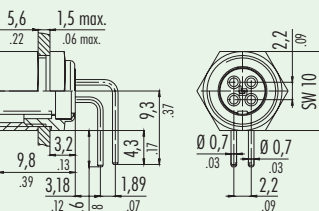
Subminiatur Rundsteckverbinder Serie 711 Subminiature circular connectors series 711		Flanschsteckverbinder Sockets			
Bezeichnung — Abbildung Description — Figure	Maßzeichnung Drawing	Polzahl Contacts	Bestell-Nr. Ordering-No		
Flanschstecker, löten Male socket, solder 		2	09-0073-00-02		
		3	09-0077-00-03		
		4	09-0081-00-04		
		5	09-0097-00-05		
		7	09-0477-00-07		
		8	09-0481-00-08		
		Flanschstecker, tauchlöten Male socket, dip-solder 		2	09-0073-20-02
				3	09-0077-20-03
4	09-0081-20-04				
5	09-0097-20-05				
7	09-0477-22-07				
8	09-0481-22-08				
Flanschstecker mit flexibler Leiterplatte Male socket with flexible PCB 	 <p>Weitere Maße siehe Seite 711-7 Additional dimensions see page 711-7</p>			—	—
				—	—
		—	—		
		—	—		
		7	09-0477-65-07		
		8	09-0481-65-08		
		Flanschdose, löten Female socket, solder 		2	09-0074-00-02
				3	09-0078-00-03
4	09-0082-00-04				
5	09-0098-00-05				
7	09-0478-00-07				
8	09-0482-00-08				
Flanschdose, tauchlöten Female socket, dip-solder 				2	09-0074-20-02
				3	09-0078-20-03
		4	09-0082-20-04		
		5	09-0098-20-05		
		7	09-0478-22-07		
		8	09-0482-22-08		
		Flanschdose mit flexibler Leiterplatte Female socket with flexible PCB 	 <p>Weitere Maße siehe Seite 711-7 Additional dimensions see page 711-7</p>	—	—
				—	—
—	—				
—	—				
7	09-0478-65-07				
8	09-0482-65-08				
Flanschdose, gewinkelt Female socket, angled 				—	—
				—	—
		4	09-0082-32-04		
		5	09-0098-72-05		
		—	—		
		—	—		

Subminiatur Rundsteckverbinder Serie 711 Subminiature circular connectors series 711

Polbilder, Montagehinweise Contact arrangement, assembly instruction

Polbilder mit Sicht auf Lötanschlussseite der Stifteinsätze
Contact arrangements with view on solder termination side of male inserts

2 pol
2 contacts

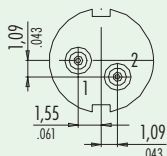

3 pol
3 contacts

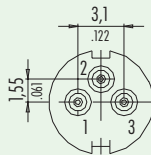

4 pol
4 contacts

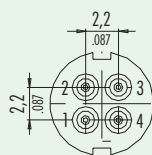

Montageausschnitt
Panel cut out

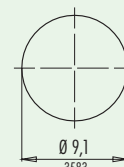

5 pol
5 contacts

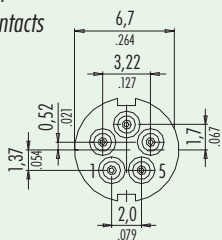

7 pol
7 contacts

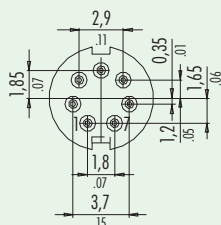

8 pol
8 contacts

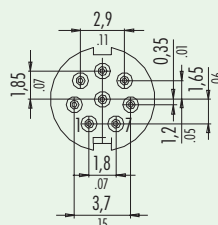

Einzelteildarstellung
Component part drawing

Kabelstecker
Male connector

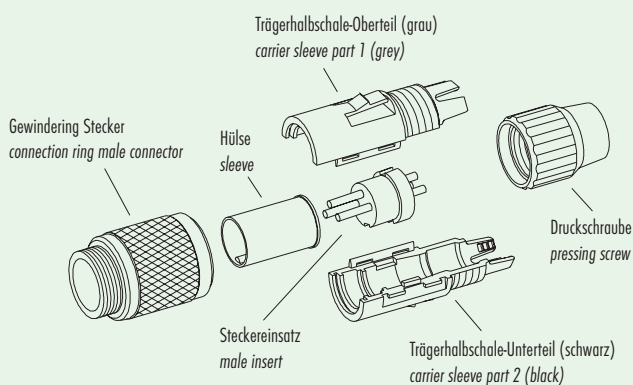

Kabeldose
Female connector

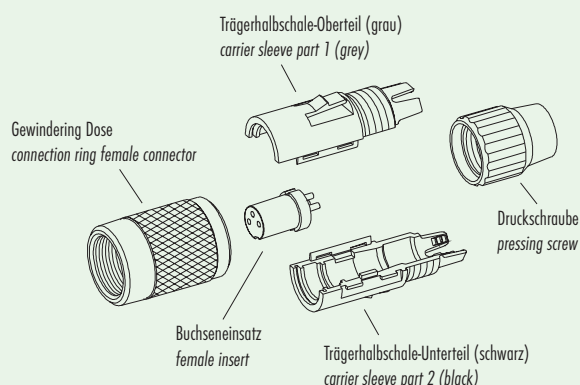

Achtung: max. Drehmoment des Gewindinges im Flanschsteckverbinder: 50 cNm (handfest)
Attention: max. torque of ring nut in socket connector: 50 cNm (manual adjustment)

Zubehör
Accessories

Bezeichnung
Description

Abbildung
Figure

Maßzeichnung
Drawing

Bestell Nr.
Ordering Nr.

Montageschlüssel
Mounting spanner

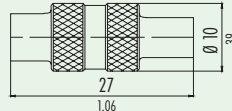

01-5059-001

Ü

TI

620

702

709

710

711

712

719

423

425

440

581

678

680

682

720

723

623

690

691

692

693

694

707

713

718

733

763

765

768

714

715

766

815

820

825

876

772

775

A

B

C

R