

JST

Crimp

1.0mm
(.039") pitch

SH CONNECTOR

Disconnectable Crimp style connectors

Emboss Tape

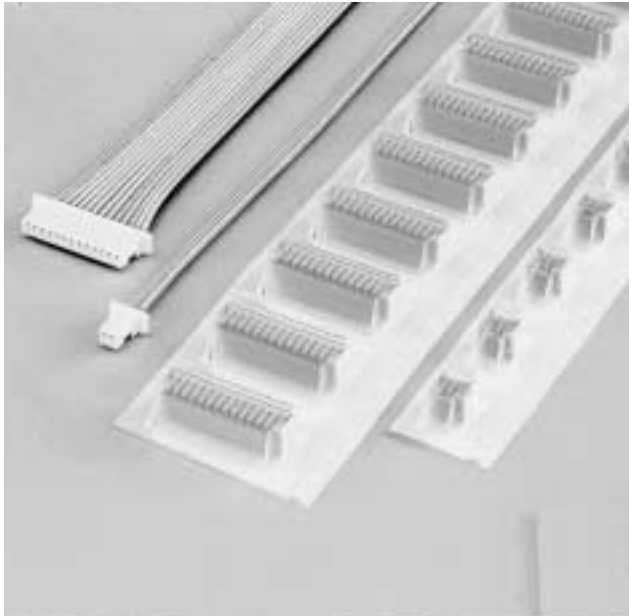

The world's first 1.0mm (.039") pitch crimp style connector.

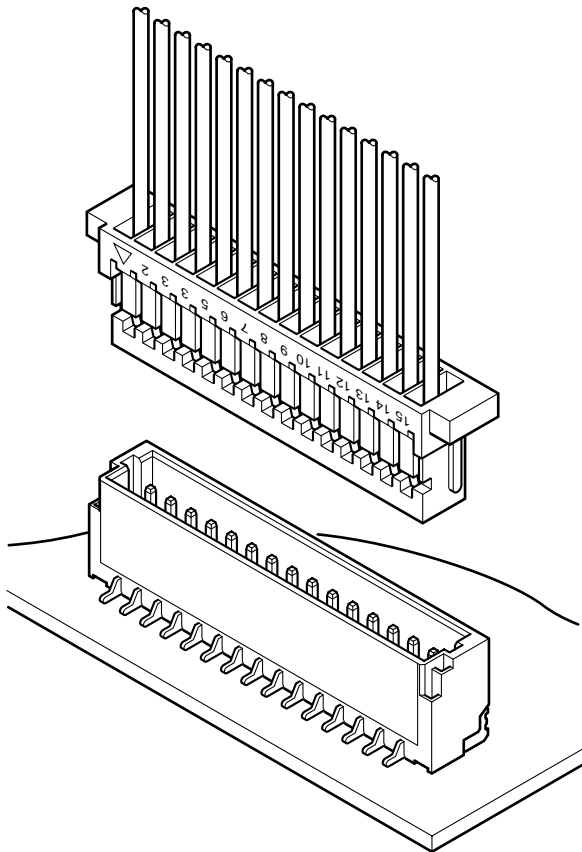

Features

• **Ultra-compact, low profile design**

The SH connector is very small with a mounting height of 2.95mm (.116") for side entry type.

• **Compatible with the SR insulation displacement connectors**

The same shrouded header can be used for the SR insulation displacement connector.

• **Housing lances**

The contact retention lances on the resilient housing allow the confirmation of contact lock-in for easy and secure insertion.

Specifications

- Current rating: 1.0A AC, DC (AWG #28)
 - Voltage rating: 50V AC, DC
 - Temperature range: -25°C to +85°C
(including temperature rise in applying electrical current)
 - Contact resistance: Initial value/20m Ω max.
After environmental testing/40m Ω max.
 - Insulation resistance: 100M Ω min.
 - Withstanding voltage: 500V AC/minute
 - Applicable wire: AWG #32 to #28
Insulation O.D./0.4 to 0.8mm (.016" to .031")
- * Contact JST for details.

Standards

- Recognized E60389
- 1 Certified LR20812

SH CONNECTOR

Contact

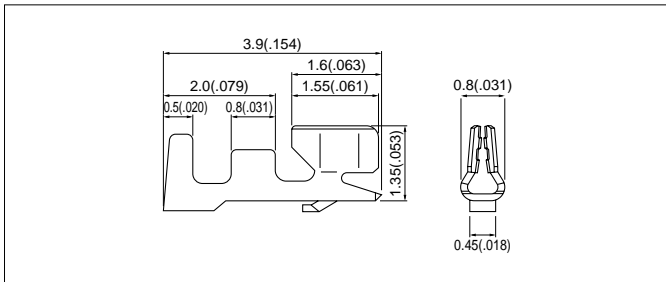

Model No.	Applicable wire			Q'ty / reel
	mm ²	AWG#	Insulation O.D. mm(in.)	
SSH-003T-P0.2	0.032 to 0.08	32 to 28	0.4 to 0.8(.016 to .031)	23,000

Material and Finish
Phosphor bronze, tin-plated

Note: Contact JST for gold-plated contacts.

Housing

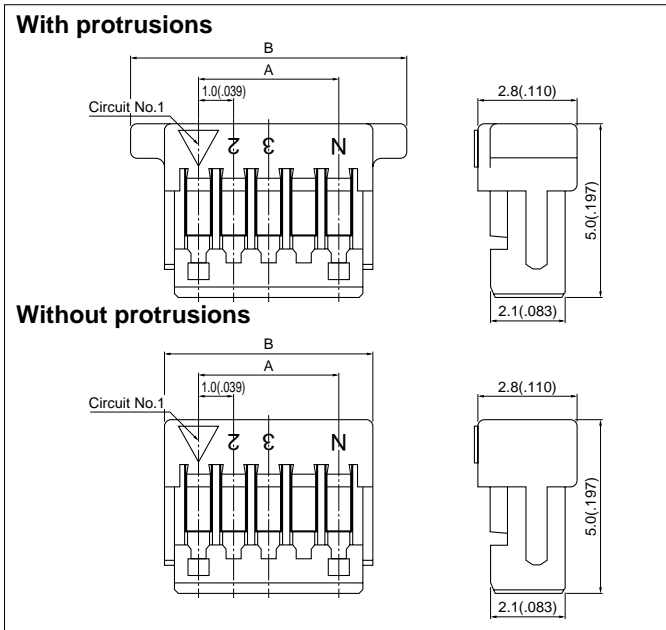

Circuits	Model No.		Dimensions mm(in.)				Q'ty / box
			A		B		
	With protrusions	Without protrusions	With protrusions	Without protrusions	With protrusions	Without protrusions	
2	SHR-02V-S-B	SHR-02V-S	1.0(.039)	5.0(.197)	3.0(.118)	2,000	
3	SHR-03V-S-B	SHR-03V-S	2.0(.079)	6.0(.236)	4.0(.157)	2,000	
4	SHR-04V-S-B	SHR-04V-S	3.0(.118)	7.0(.276)	5.0(.197)	2,000	
5	SHR-05V-S-B	SHR-05V-S	4.0(.157)	8.0(.315)	6.0(.236)	2,000	
6	SHR-06V-S-B	SHR-06V-S	5.0(.197)	9.0(.354)	7.0(.276)	2,000	
7	SHR-07V-S-B	SHR-07V-S	6.0(.236)	10.0(.394)	8.0(.315)	2,000	
8	SHR-08V-S-B	SHR-08V-S	7.0(.276)	11.0(.433)	9.0(.354)	2,000	
9	SHR-09V-S-B	SHR-09V-S	8.0(.315)	12.0(.472)	10.0(.394)	2,000	
10	SHR-10V-S-B	SHR-10V-S	9.0(.354)	13.0(.512)	11.0(.433)	2,000	
11	SHR-11V-S-B	SHR-11V-S	10.0(.394)	14.0(.551)	12.0(.472)	2,000	
12	SHR-12V-S-B	SHR-12V-S	11.0(.433)	15.0(.591)	13.0(.512)	2,000	
13	SHR-13V-S-B	SHR-13V-S	12.0(.472)	16.0(.630)	14.0(.551)	2,000	
14	SHR-14V-S-B	SHR-14V-S	13.0(.512)	17.0(.669)	15.0(.591)	2,000	
15	SHR-15V-S-B	SHR-15V-S	14.0(.551)	18.0(.709)	16.0(.630)	2,000	
20	SHR-20V-S-B	-	19.0(.748)	23.0(.906)	21.0(.827)	2,000	

Material

PBT, UL94V-0, natural (white)

Shrouded header

The shrouded headers are interchangeable with those of the SR insulation displacement connectors.

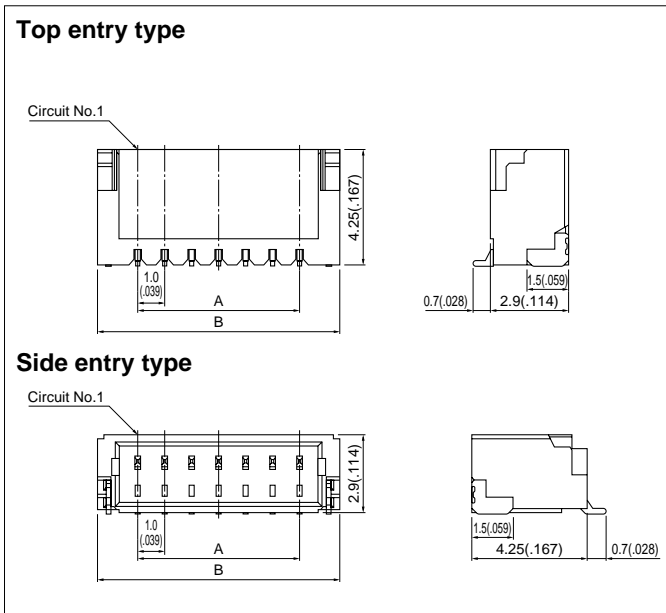

Circuits	Model No.		Dimensions mm(in.)		Q'ty / reel	
	Top entry type	Side entry type	A	B	Top entry type	Side entry type
	2	BM02B-SRSS-TB	SM02B-SRSS-TB	1.0(.039)	4.0(.157)	1,500
3	BM03B-SRSS-TB	SM03B-SRSS-TB	2.0(.079)	5.0(.197)	1,500	3,000
4	BM04B-SRSS-TB	SM04B-SRSS-TB	3.0(.118)	6.0(.236)	1,500	3,000
5	BM05B-SRSS-TB	SM05B-SRSS-TB	4.0(.157)	7.0(.276)	1,500	3,000
6	BM06B-SRSS-TB	SM06B-SRSS-TB	5.0(.197)	8.0(.315)	1,500	3,000
7	BM07B-SRSS-TB	SM07B-SRSS-TB	6.0(.236)	9.0(.354)	1,500	3,000
8	BM08B-SRSS-TB	SM08B-SRSS-TB	7.0(.276)	10.0(.394)	1,500	3,000
9	BM09B-SRSS-TB	SM09B-SRSS-TB	8.0(.315)	11.0(.433)	1,500	3,000
10	BM10B-SRSS-TB	SM10B-SRSS-TB	9.0(.354)	12.0(.472)	1,500	3,000
11	BM11B-SRSS-TB	SM11B-SRSS-TB	10.0(.394)	13.0(.512)	1,500	3,000
12	BM12B-SRSS-TB	SM12B-SRSS-TB	11.0(.433)	14.0(.551)	1,500	3,000
13	BM13B-SRSS-TB	SM13B-SRSS-TB	12.0(.472)	15.0(.591)	1,500	3,000
14	BM14B-SRSS-TB	SM14B-SRSS-TB	13.0(.512)	16.0(.630)	1,500	3,000
15	-	SM15B-SRSS-TB	14.0(.551)	17.0(.669)	-	3,000
20	-	SM20B-SRSS-TB	19.0(.748)	22.0(.866)	-	3,000

Material and Finish

Contact: Copper alloy, copper-undercoated, tin/lead-plated
Housing: Polyamide, UL94V-0, natural (ivory)
Solder tab: Brass, copper-undercoated, tin/lead-plated

Note: 1. The products listed above are supplied on embossed-tape.
2. Contact JST for the headers with gold-plated pins.
3. Contact JST for the top entry type headers with suction cap.

SH CONNECTOR

Taping specifications

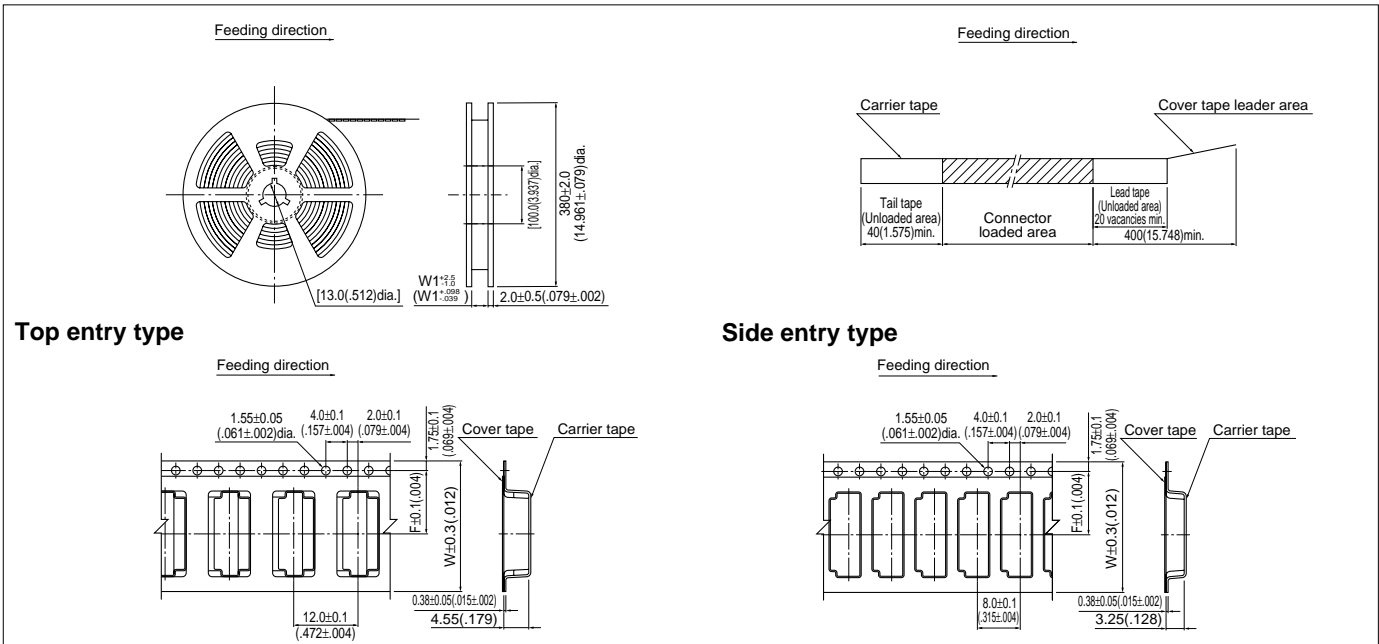

Circuits	Taping dimensions mm(in.)				Reel dimensions mm(in.)		Qty / reel	
	F		W		W1		Top entry type	Side entry type
	Top entry type	Side entry type	Top entry type	Side entry type	Top entry type	Side entry type		
2	5.5(.217)	5.5(.217)	12.0(.472)	12.0(.472)	13.5(.531)	13.5(.531)	1,500	3,000
3	5.5(.217)	5.5(.217)	12.0(.472)	12.0(.472)	13.5(.531)	13.5(.531)	1,500	3,000
4	7.5(.295)	5.5(.217)	16.0(.630)	12.0(.472)	17.5(.689)	13.5(.531)	1,500	3,000
5	7.5(.295)	7.5(.295)	16.0(.630)	16.0(.630)	17.5(.689)	17.5(.689)	1,500	3,000
6	7.5(.295)	7.5(.295)	16.0(.630)	16.0(.630)	17.5(.689)	17.5(.689)	1,500	3,000
7	7.5(.295)	7.5(.295)	16.0(.630)	16.0(.630)	17.5(.689)	17.5(.689)	1,500	3,000
8	11.5(.453)	7.5(.295)	24.0(.945)	16.0(.630)	25.5(1.004)	17.5(.689)	1,500	3,000
9	11.5(.453)	11.5(.453)	24.0(.945)	24.0(.945)	25.5(1.004)	25.5(1.004)	1,500	3,000
10	11.5(.453)	11.5(.453)	24.0(.945)	24.0(.945)	25.5(1.004)	25.5(1.004)	1,500	3,000
11	11.5(.453)	11.5(.453)	24.0(.945)	24.0(.945)	25.5(1.004)	25.5(1.004)	1,500	3,000
12	11.5(.453)	11.5(.453)	24.0(.945)	24.0(.945)	25.5(1.004)	25.5(1.004)	1,500	3,000
13	11.5(.453)	11.5(.453)	24.0(.945)	24.0(.945)	25.5(1.004)	25.5(1.004)	1,500	3,000
14	11.5(.453)	11.5(.453)	24.0(.945)	24.0(.945)	25.5(1.004)	25.5(1.004)	1,500	3,000
15	-	11.5(.453)	-	24.0(.945)	-	25.5(1.004)	-	3,000
20	-	20.2(.795)	-	44.0(1.732)	-	45.5(1.791)	-	3,000

Note: 1. Specifications conform to JIS C 0806. The tape width, connector loading recess square dimensions, etc. are determined by the number of circuits and external shape of the connector to be loaded.
 2. Specifications are subject to change without prior notice.

PC board layout (viewed from component side) and Assembly layout

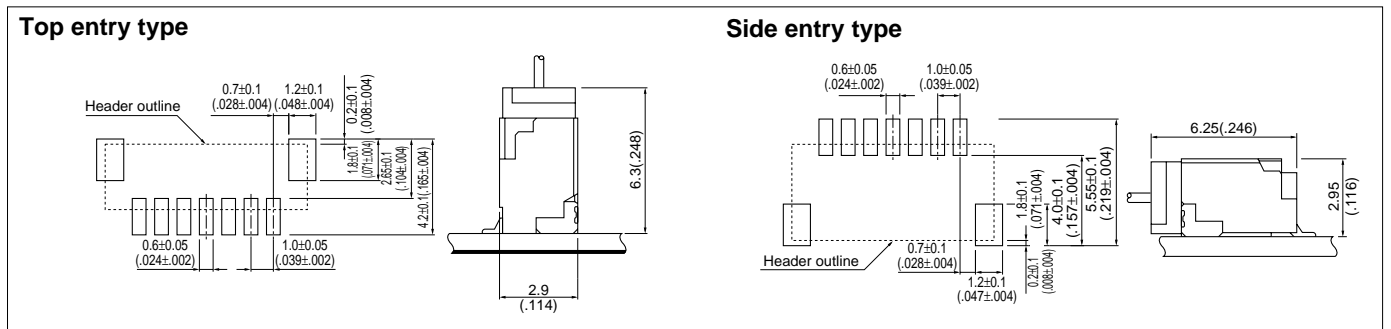

Note:

1. Tolerances are non-cumulative: $\pm 0.05\text{mm}(\pm .002")$ for all centers.
2. The dimensions above should serve as a guideline. Contact JST for details.

Applicator for the semi-automatic press AP-K2N

Contact	Crimp applicator MKS-L-10-3		Compact crimp applicator MKS-LS		Strip-crimp applicator MKS-SC
	with safety cover	without safety cover	with safety cover	without safety cover	with safety cover
SSH-003T-P0.2	APLMK SSH/L003-02	APLNC SSH/L003-02	-	-	APLSC SSH003-02