

N-channel 1050 V, 1.4 Ω typ., 4 A MDmesh™ K5
Power MOSFETs in TO-220, IPAK and TO-247 packages

Datasheet - production data

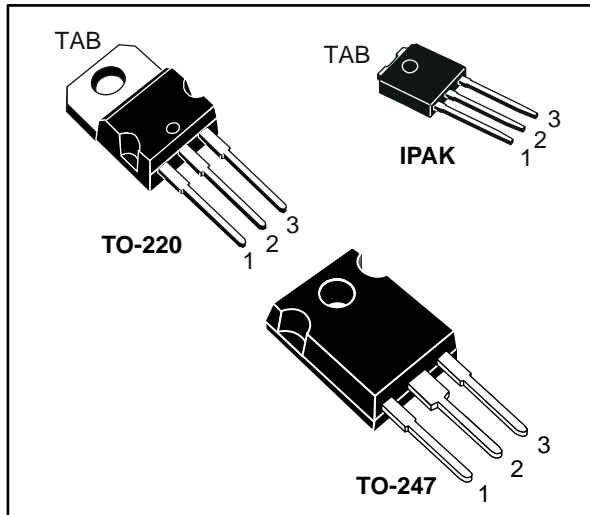
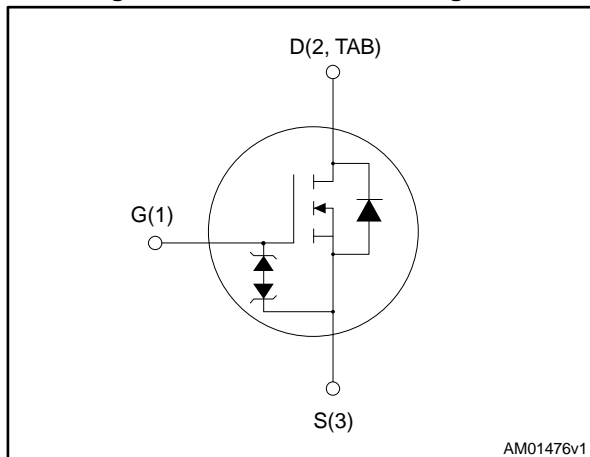

Figure 1: Internal schematic diagram



Features

Order code	V _{DS}	R _{DS(on)} max.	I _D	P _{TOT}
STP7N105K5	1050 V	2 Ω	4 A	110 W
STU7N105K5				
STW7N105K5				

- Industry's lowest R_{DS(on)} x area
- Industry's best FoM (figure of merit)
- Ultra-low gate charge
- 100% avalanche tested
- Zener-protected

Applications

- Switching applications

Description

This very high voltage N-channel Power MOSFET is designed using MDmesh™ K5 technology based on an innovative proprietary vertical structure. The result is a dramatic reduction in on-resistance and ultra-low gate charge for applications requiring superior power density and high efficiency.

Table 1: Device summary

Order code	Marking	Package	Packaging
STP7N105K5	7N105K5	TO-220	Tube
STU7N105K5		IPAK	
STW7N105K5		TO-247	

Contents

1	Electrical ratings	3
2	Electrical characteristics	4
	2.1 Electrical characteristics (curves).....	6
3	Test circuits	9
4	Package information	10
	4.1 TO-220 package information.....	11
	4.2 IPAK package information.....	13
	4.3 TO-247 package information.....	15
5	Revision history	17

1 Electrical ratings

Table 2: Absolute maximum ratings

Symbol	Parameter	Value	Unit
V _{GS}	Gate- source voltage	± 30	V
I _D	Drain current (continuous) at T _C = 25 °C	4	A
I _D	Drain current (continuous) at T _C = 100 °C	3	A
I _{DM} ⁽¹⁾	Drain current (pulsed)	16	A
P _{TOT}	Total dissipation at T _C = 25 °C	110	W
I _{AR}	Avalanche current, repetitive or not repetitive (pulse width limited by T _{jmax})	1.5	A
E _{AS}	Single pulse avalanche energy (starting T _J = 25 °C, I _D =I _{AR} , V _{DD} = 50 V)	132	mJ
dv/dt ⁽²⁾	Peak diode recovery voltage slope	4.5	V/ns
dv/dt ⁽³⁾	MOSFET dv/dt ruggedness	50	V/ns
T _j	Operating junction temperature range	- 55 to 150	°C
T _{stg}	Storage temperature range		

Notes:

⁽¹⁾Pulse width limited by safe operating area.

⁽²⁾I_{SD} ≤ 4 A, di/dt ≤ 100 A/μs, V_{DS(peak)} ≤ V_{(BR)DSS} ; V_{SD} ≤ 840 V

⁽³⁾V_{DS} ≤ 840 V

Table 3: Thermal data

Symbol	Parameter	Value			Unit
		TO-220	IPAK	TO-247	
R _{thj-case}	Thermal resistance junction-case max	1.14			°C/W
R _{thj-amb}	Thermal resistance junction-amb max	62.5	100	50	°C/W

2 Electrical characteristics

(T_{CASE} = 25 °C unless otherwise specified).

Table 4: On/off states

Symbol	Parameter	Test conditions	Min.	Typ.	Max.	Unit
V _{(BR)DSS}	Drain-source breakdown voltage	V _{GS} = 0, I _D = 1 mA	1050			V
I _{DSS}	Zero gate voltage drain current	V _{GS} = 0, V _{DS} = 1050 V			1	μA
		V _{GS} = 0, V _{DS} = 1050 V, T _C = 125 °C ⁽¹⁾			50	μA
I _{GSS}	Gate body leakage current	V _{DS} = 0, V _{GS} = ± 20 V			±10	μA
V _{GS(th)}	Gate threshold voltage	V _{DS} = V _{GS} , I _D = 100 μA	3	4	5	V
R _{DS(on)}	Static drain-source on-resistance	V _{GS} = 10 V, I _D = 2 A		1.4	2	Ω

Notes:

⁽¹⁾Defined by design, not subject to production test.

Table 5: Dynamic

Symbol	Parameter	Test conditions	Min.	Typ.	Max.	Unit
C _{iss}	Input capacitance	V _{DS} = 100 V, f = 1 MHz, V _{GS} = 0	-	380	-	pF
C _{oss}	Output capacitance		-	40	-	pF
C _{rss}	Reverse transfer capacitance		-	0.65	-	pF
C _{o(tr)} ⁽¹⁾	Equivalent capacitance time related	V _{GS} = 0, V _{DS} = 0 to 840 V	-	47	-	pF
C _{o(er)} ⁽²⁾	Equivalent capacitance energy related		-	17	-	pF
R _G	Intrinsic gate resistance	f = 1MHz open drain	-	7	-	Ω
Q _g	Total gate charge	V _{DD} = 840 V, I _D = 4 A	-	11	-	nC
Q _{gs}	Gate-source charge	V _{GS} = 10 V	-	2.8	-	nC
Q _{gd}	Gate-drain charge	<i>Figure 18: "Test circuit for gate charge behavior"</i>	-	5.6	-	nC

Notes:

⁽¹⁾Time related is defined as a constant equivalent capacitance giving the same charging time as C_{oss} when V_{DS} increases from 0 to 80% V_{DSS}

⁽²⁾Energy related is defined as a constant equivalent capacitance giving the same stored energy as C_{oss} when V_{DS} increases from 0 to 80% V_{DSS}

Table 6: Switching times

Symbol	Parameter	Test conditions	Min.	Typ.	Max.	Unit
$t_{d(on)}$	Turn-on delay time	$V_{DD} = 525V$, $I_D = 2 A$, $R_G = 4.7 \Omega$, $V_{GS} = 10 V$ (see Figure 17: "Test circuit for resistive load switching times" and Figure 22: "Switching time waveform")	-	17.5	-	ns
t_r	Rise time		-	7	-	ns
$t_{d(off)}$	Turn-off delay time		-	43	-	ns
t_f	Fall time		-	25	-	ns

Table 7: Source drain diode

Symbol	Parameter	Test conditions	Min.	Typ.	Max.	Unit
I_{SD}	Source-drain current		-		4	A
I_{SDM}	Source-drain current (pulsed)				16	A
$V_{SD}^{(1)}$	Forward on voltage	$I_{SD} = 4 A$, $V_{GS} = 0$	-		1.6	V
t_{rr}	Reverse recovery time	$I_{SD} = 4 A$, $V_{DD} = 60 V$ $di/dt = 100 A/\mu s$, Figure 19: "Test circuit for inductive load switching and diode recovery times"	-	370		ns
Q_{rr}	Reverse recovery charge		-	3		μC
I_{RRM}	Reverse recovery current		-	16.5		A
t_{rr}	Reverse recovery time	$I_{SD} = 4 A$, $V_{DD} = 60 V$ $di/dt = 100 A/\mu s$, $T_j = 150 ^\circ C$ Figure 19: "Test circuit for inductive load switching and diode recovery times"	-	600		ns
Q_{rr}	Reverse recovery charge		-	4.4		μC
I_{RRM}	Reverse recovery current		-	14.5		A

Notes:

⁽¹⁾Pulsed: pulse duration = 300 μs , duty cycle 1.5%

Table 8: Gate-source Zener diode

Symbol	Parameter	Test conditions	Min	Typ.	Max.	Unit
$V_{(BR)GSO}$	Gate-source breakdown voltage	$I_{GS} = \pm 1mA$, $I_D = 0$	30	-	-	V

The built-in back-to-back Zener diodes are specifically designed to enhance the ESD performance of the device. The Zener voltage facilitates efficient and cost-effective device integrity protection, thus eliminating the need for additional external componentry.

2.1 Electrical characteristics (curves)

Figure 2: Safe operating area for TO-220 and TO-247

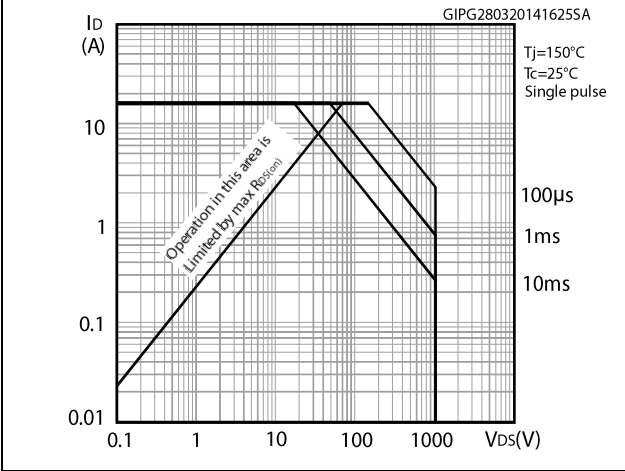

Figure 3: Thermal impedance for TO-220 and TO-247

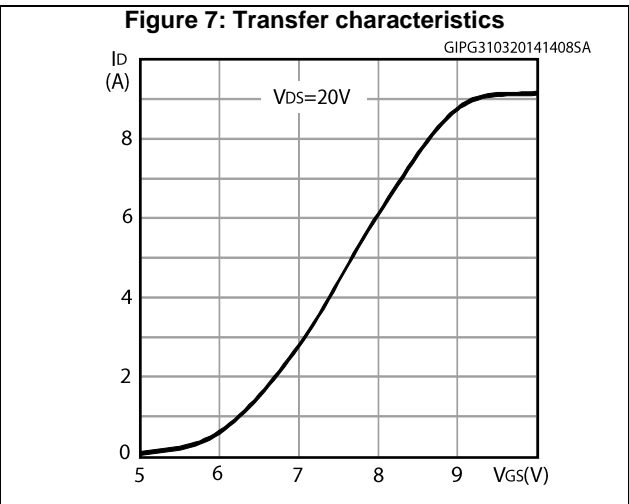
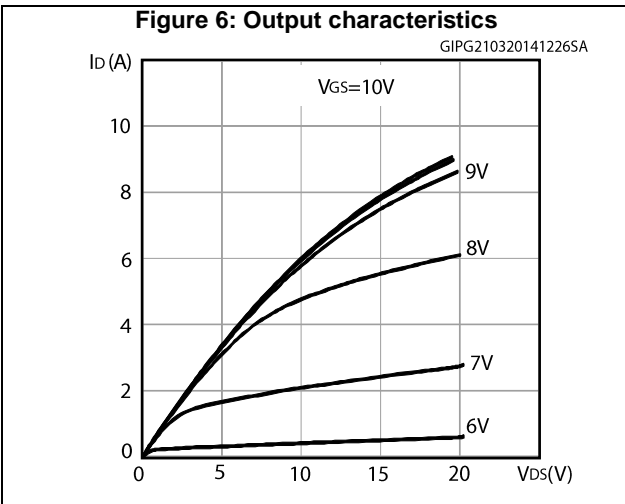
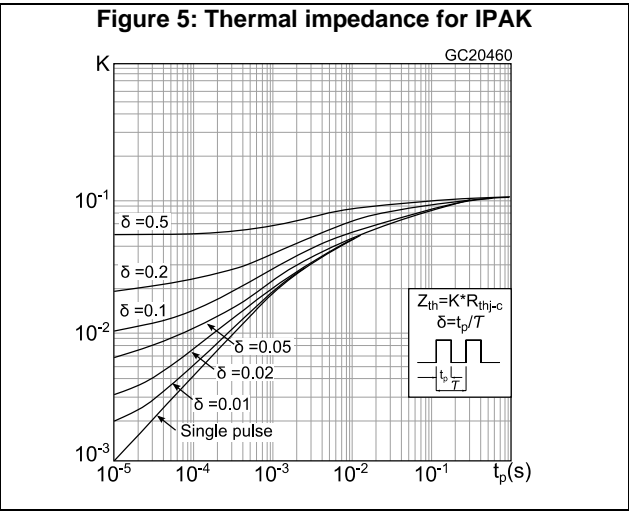
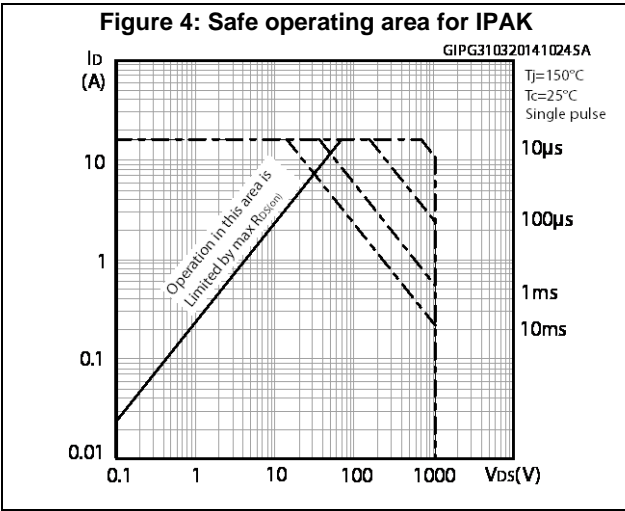
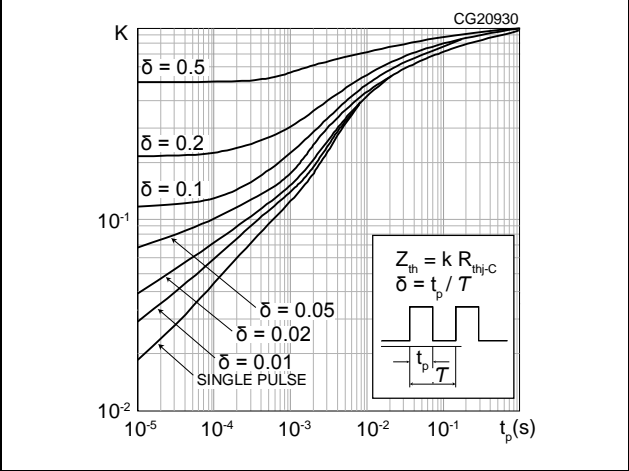

Figure 8: Gate charge vs gate-source voltage

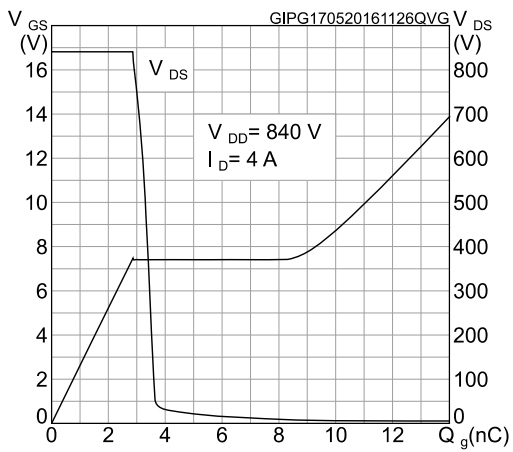

Figure 9: Static drain-source on-resistance

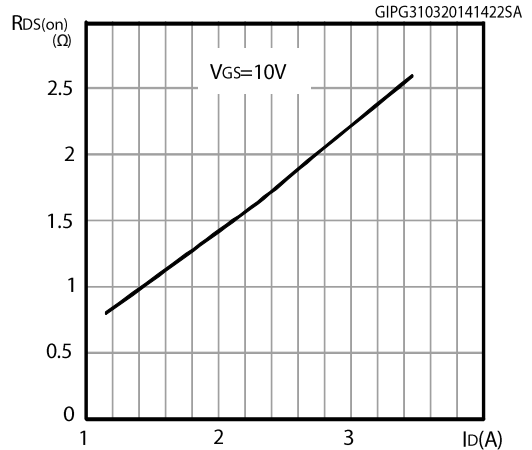

Figure 10: Capacitance variations

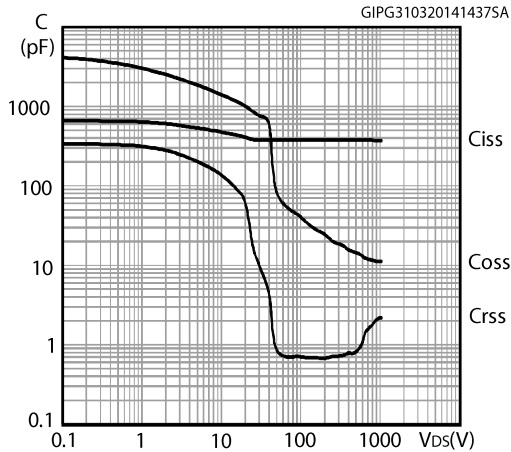

Figure 11: Source-drain diode forward characteristics

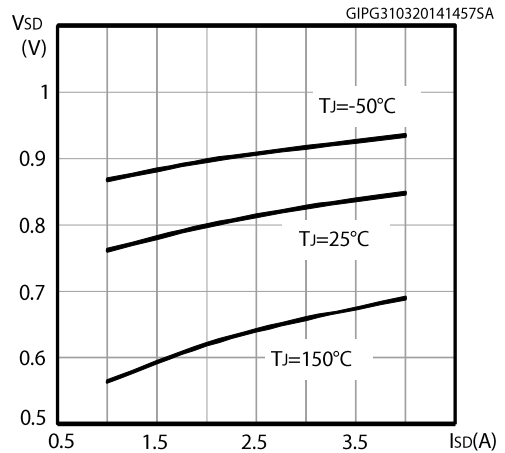

Figure 12: Normalized gate threshold voltage vs temperature

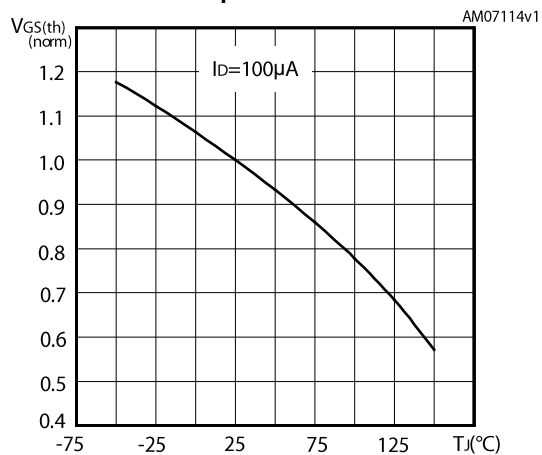

Figure 13: Normalized on-resistance vs temperature

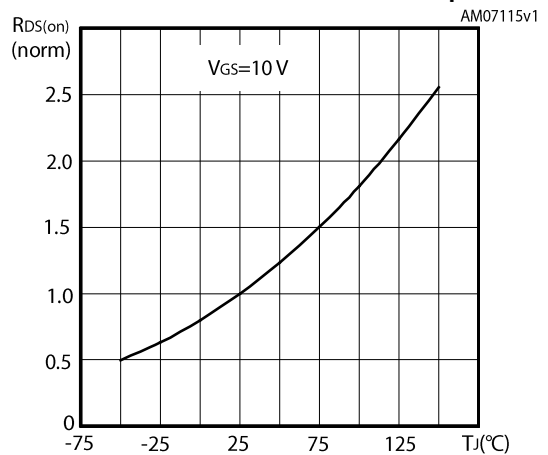

Figure 14: Normalized V(BR)DSS vs temperature

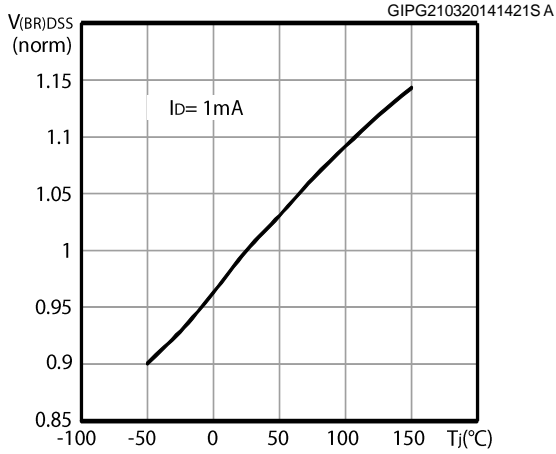

Figure 15: Maximum avalanche energy vs starting Tj

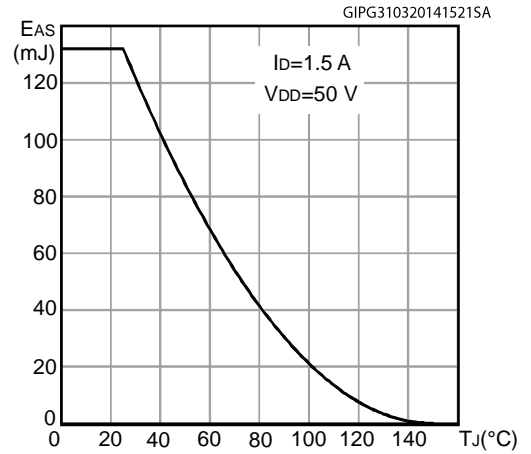
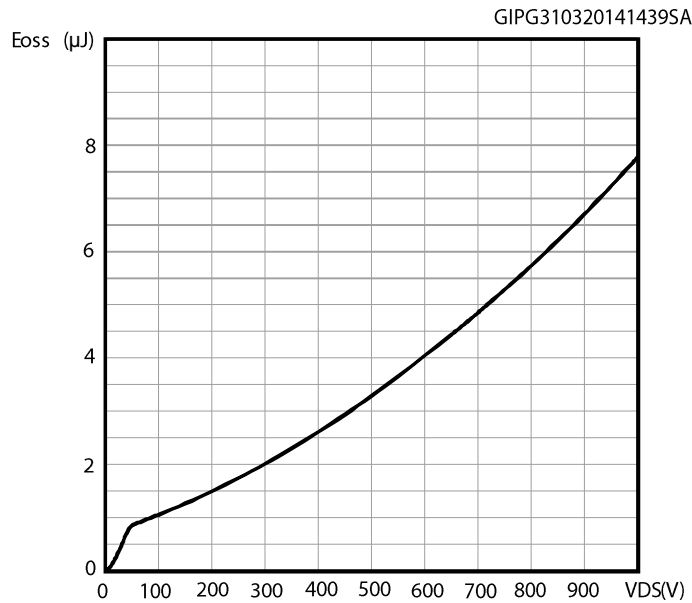

Figure 16: Output capacitance stored energy



3 Test circuits

Figure 17: Test circuit for resistive load switching times



AM01468v1

Figure 18: Test circuit for gate charge behavior



AM01469v1

Figure 19: Test circuit for inductive load switching and diode recovery times

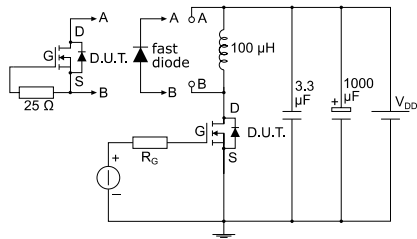

AM01470v1

Figure 20: Unclamped inductive load test circuit

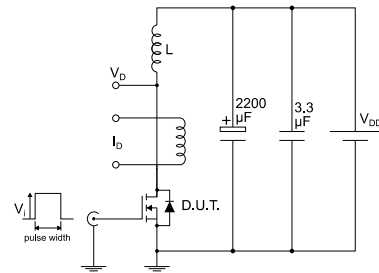

AM01471v1

Figure 21: Unclamped inductive waveform

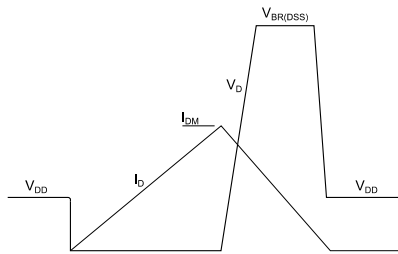

AM01472v1

Figure 22: Switching time waveform

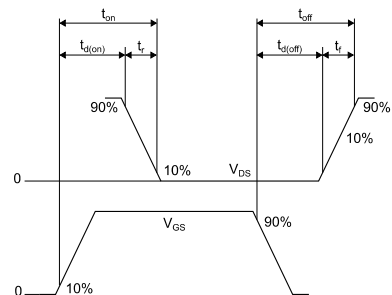

AM01473v1

4 Package information

In order to meet environmental requirements, ST offers these devices in different grades of ECOPACK® packages, depending on their level of environmental compliance. ECOPACK® specifications, grade definitions and product status are available at: www.st.com. ECOPACK® is an ST trademark.

4.1 TO-220 package information

Figure 23: TO-220 type A package outline

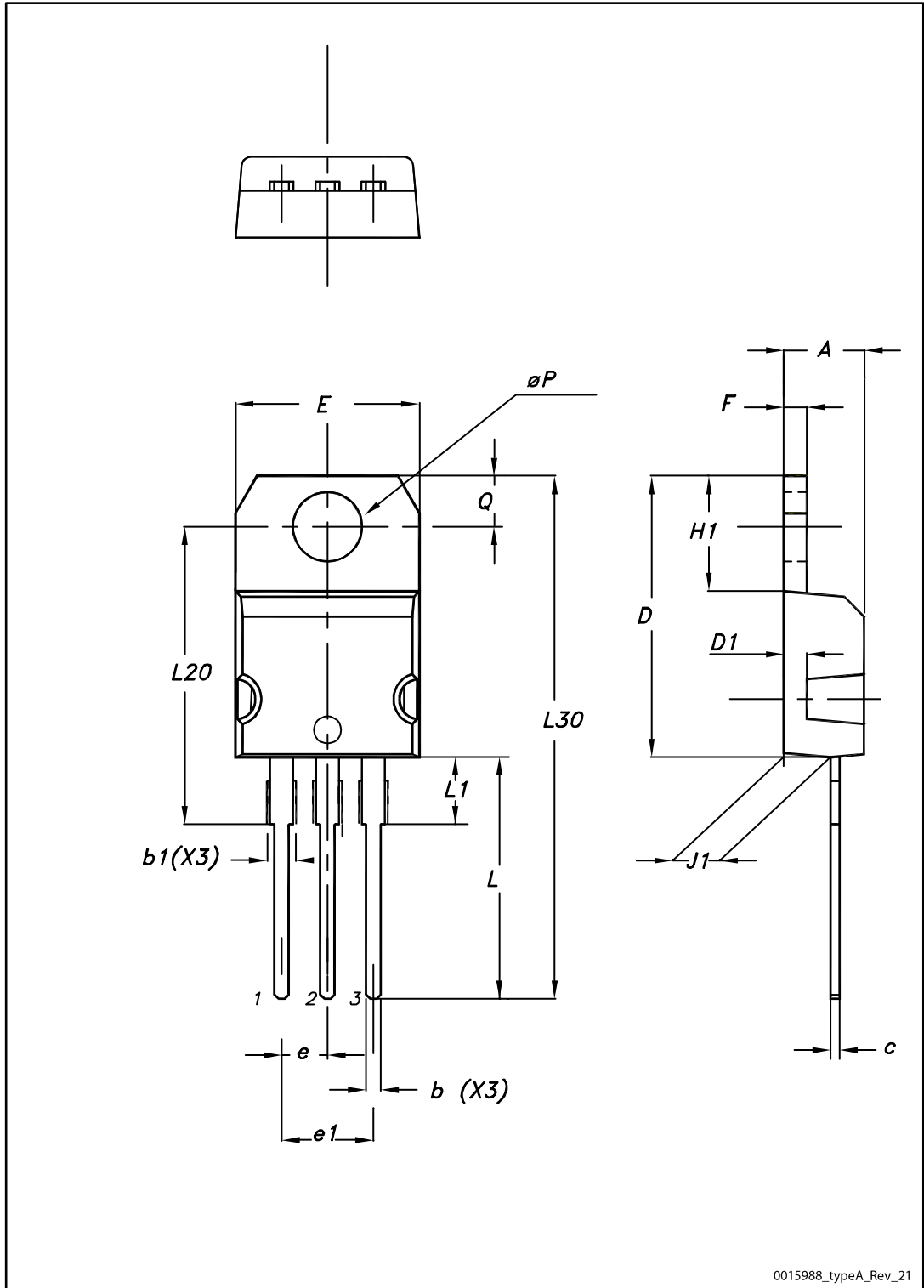

Table 9: TO-220 type A mechanical data

Dim.	mm		
	Min.	Typ.	Max.
A	4.40		4.60
b	0.61		0.88
b1	1.14		1.55
c	0.48		0.70
D	15.25		15.75
D1		1.27	
E	10.00		10.40
e	2.40		2.70
e1	4.95		5.15
F	1.23		1.32
H1	6.20		6.60
J1	2.40		2.72
L	13.00		14.00
L1	3.50		3.93
L20		16.40	
L30		28.90	
øP	3.75		3.85
Q	2.65		2.95

4.2 IPAK package information

Figure 24: IPAK (TO-251) type A package outline

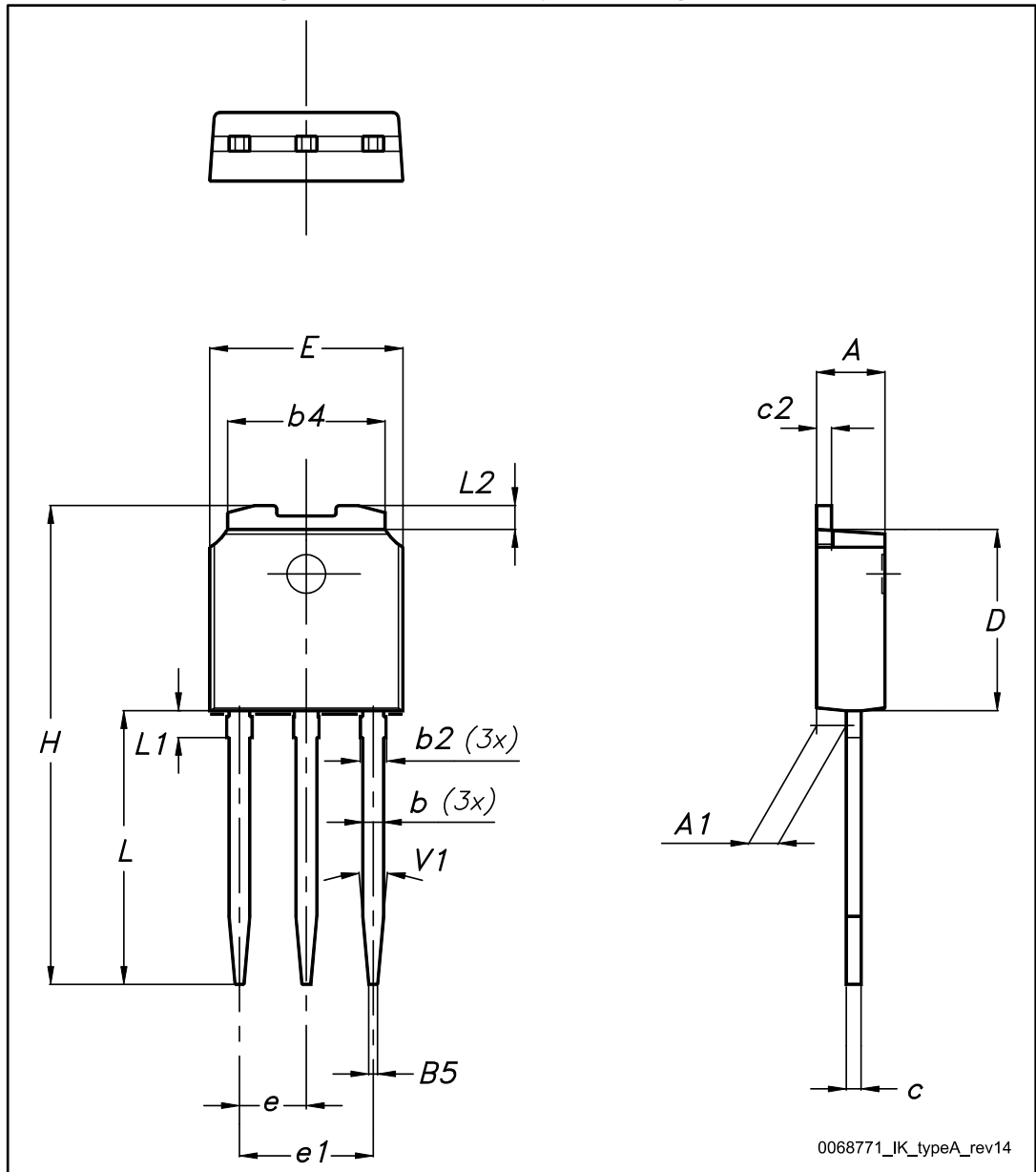

Table 10: IPAK (TO-251) type A package mechanical data

Dim.	mm		
	Min.	Typ.	Max.
A	2.20		2.40
A1	0.90		1.10
b	0.64		0.90
b2			0.95
b4	5.20		5.40
B5		0.30	
c	0.45		0.60
c2	0.48		0.60
D	6.00		6.20
E	6.40		6.60
e		2.28	
e1	4.40		4.60
H		16.10	
L	9.00		9.40
L1	0.80		1.20
L2		0.80	1.00
V1		10°	

4.3 TO-247 package information

Figure 25: TO-247 package outline

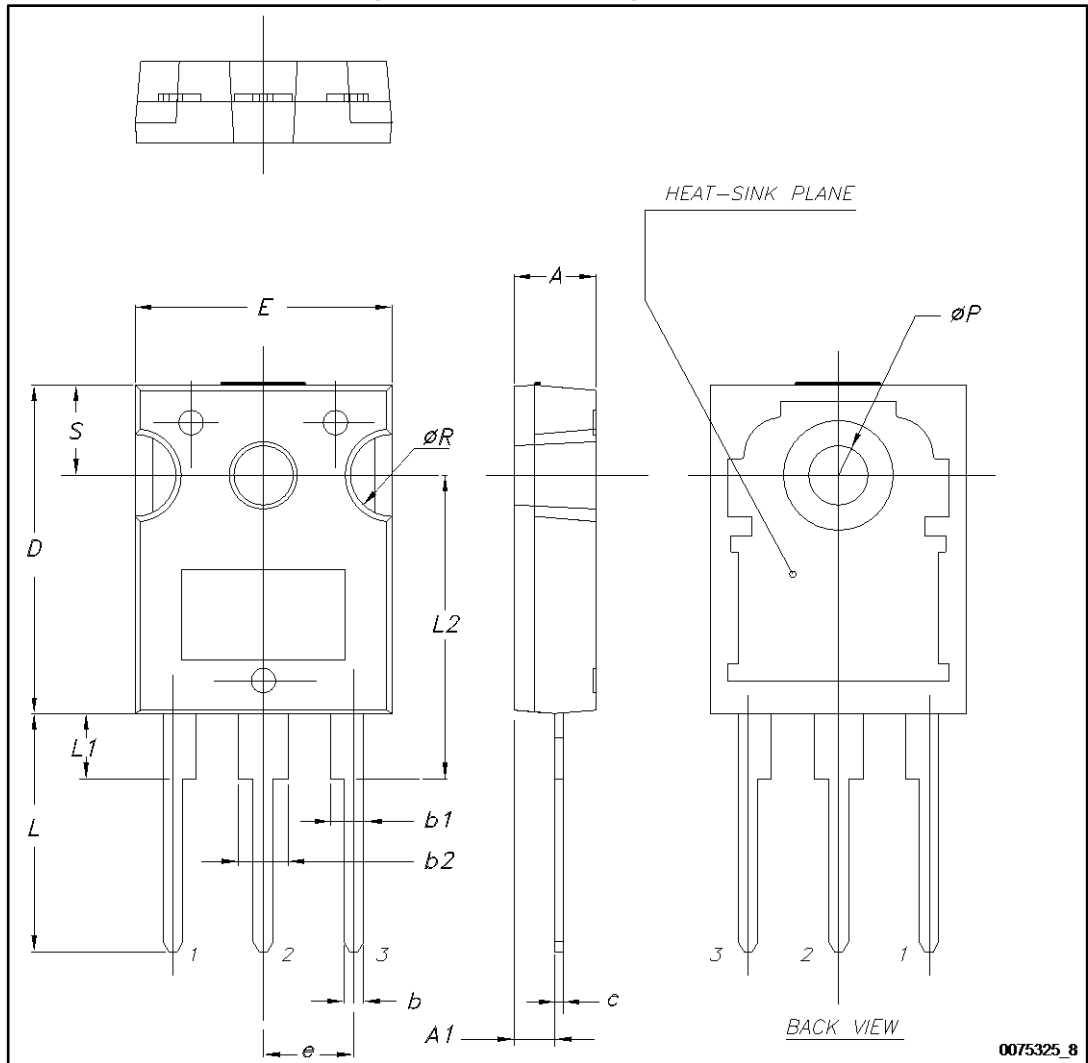

Table 11: TO-247 package mechanical data

Dim.	mm		
	Min.	Typ.	Max.
A	4.85		5.15
A1	2.20		2.60
b	1.0		1.40
b1	2.0		2.40
b2	3.0		3.40
c	0.40		0.80
D	19.85		20.15
E	15.45		15.75
e	5.30	5.45	5.60
L	14.20		14.80
L1	3.70		4.30
L2		18.50	
ØP	3.55		3.65
ØR	4.50		5.50
S	5.30	5.50	5.70

5 Revision history

Table 12: Document revision history

Date	Revision	Changes
07-Apr-2014	1	First release.
17-Oct-2016	2	Updated <i>Figure 8: "Gate charge vs gate-source voltage"</i> and <i>Table 5: "Dynamic"</i> . Minor text changes.

IMPORTANT NOTICE – PLEASE READ CAREFULLY

STMicroelectronics NV and its subsidiaries ("ST") reserve the right to make changes, corrections, enhancements, modifications, and improvements to ST products and/or to this document at any time without notice. Purchasers should obtain the latest relevant information on ST products before placing orders. ST products are sold pursuant to ST's terms and conditions of sale in place at the time of order acknowledgement.

Purchasers are solely responsible for the choice, selection, and use of ST products and ST assumes no liability for application assistance or the design of Purchasers' products.

No license, express or implied, to any intellectual property right is granted by ST herein.

Resale of ST products with provisions different from the information set forth herein shall void any warranty granted by ST for such product.

ST and the ST logo are trademarks of ST. All other product or service names are the property of their respective owners.

Information in this document supersedes and replaces information previously supplied in any prior versions of this document.

© 2016 STMicroelectronics – All rights reserved

Mouser Electronics

Authorized Distributor

Click to View Pricing, Inventory, Delivery & Lifecycle Information:

[STMicroelectronics:](#)

[STU7N105K5](#) [STW7N105K5](#) [STP7N105K5](#)