

IEC Plug E, Cord Connector (Rewireable), Angled



Plug
Rewireable connector
angled

Example with assembled cable



See below:
[Approvals and Compliances](#)

Description

- Cord Connectors (Rewireable) , Screw-on mounting
- 1 Function
- Appliance Inlet , Pin temperature 70 °C , Protection class I
- Cable entry possible in four directions

Weblinks

[pdf data sheet](#), [html datasheet](#), [General Product Information](#), [Approvals](#), [Distributor-Stock-Check](#), [Accessories](#), [Detailed request for product](#)

Technical Data

Ratings IEC	10A / 250VAC; 50Hz	Appliance inlet/-outlet	E following IEC 60320-3,
Ratings UL/CSA	10A / 250VAC; 60Hz		UL 498, CSA C22.2 no. 42 (for cold
Dielectric Strength	> 2 kVAC between L-N > 2 kVAC between L/N-PE (1 min/50Hz)		conditions) pin-temperature 70 °C, 10A,
Allowable Operation Temperature	-25 °C to 70 °C		Protection Class I
Protection against electric shock	Suitable for appliances with protection class I acc. to IEC 61140		
Terminal	Cable		
Material: Housing	Thermoplastic, black, UL 94V-0		

Approvals and Compliances

Detailed information on product approvals, code requirements, usage instructions and detailed test conditions can be looked up in [Details about Approvals](#)

SCHURTER products are designed for use in industrial environments. They have approvals from independent testing bodies according to national and international standards. Products with specific characteristics and requirements such as required in the automotive sector according to IATF 16949, medical technology according to ISO 13485 or in the aerospace industry can be offered exclusively with customer-specific, individual agreements by SCHURTER.

Approvals

The approval mark is used by the testing authorities to certify compliance with the safety requirements placed on electronic products. Approval Reference Type: P685

Approval Logo	Certificates	Certification Body	Description
	UL Approvals	UL	UL File Number: E96454
	CSA Approvals	CSA	CSA Certification Record: 70111

Product standards

Product standards that are referenced

Organization	Design	Standard	Description
	Designed according to	IEC 60320-3	Appliance couplers for household and similar general purposes
	Designed according to	UL 498	Standard for Attachment Plugs and Receptacles
	Designed according to	CSA C22.2 no. 42	General Use Receptacles, Attachment Plugs, and Similar Wiring Devices





Application standards

Application standards where the product can be used

Organization	Design	Standard	Description
	Designed for applications acc.	IEC/UL 62368-1	IEC 62368-1 includes the basic requirements for safety of audio, video, information technology and office equipment.

Compliances

The product complies with following Guide Lines

Identification	Details	Initiator	Description
	CE declaration of conformity	SCHURTER AG	The CE marking declares that the product complies with the applicable requirements laid down in the harmonisation of Community legislation on its affixing in accordance with EU Regulation 765/2008.
	RoHS	SCHURTER AG	Directive RoHS 2011/65/EU, Amendment (EU) 2015/863
	China RoHS	SCHURTER AG	The law SJ / T 11363-2006 (China RoHS) has been in force since 1 March 2007. It is similar to the EU directive RoHS.
	REACH	SCHURTER AG	On 1 June 2007, Regulation (EC) No 1907/2006 on the Registration, Evaluation, Authorization and Restriction of Chemicals 1 (abbreviated as "REACH") entered into force.

Dimensions [mm]

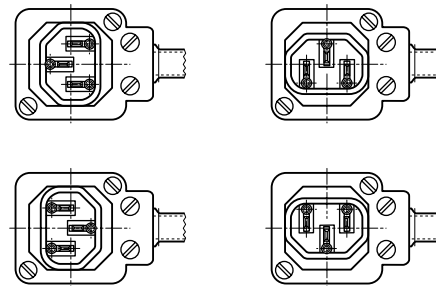
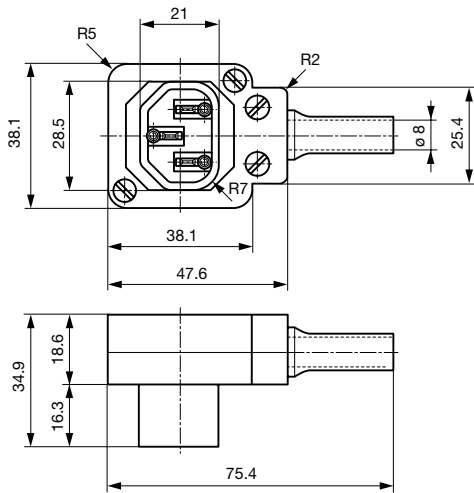

Cable entry possible in four directions

All Variants

Color	Recommended cable diameter	Max. wire size	L = Length of cable guard	Order Number
black	8.5 mm	3 x 1 mm ² / 3 x 18 AWG	-	4300.0401 

 Most Popular.

Availability for all products can be searched real-time: <https://www.schurter.com/en/Stock-Check/Stock-Check-SCHURTER>

Max. torque for screws: Terminals: 0.5 Nm, Cable clamps: 0.5 Nm, Cover: 0.5 Nm

Packaging unit 20 Pcs

Mating Outlets/Connectors

Category / Description

[Appliance Outlet Overview complete](#)



6600-5, Mounting: Snap-in version, Appliance Outlet: IEC F, For PCB mounting, 10 A, Suitable for appliances with protection class I	6600-5
6600-3, Mounting: Screw-on mounting, Appliance Outlet: IEC F, Solder/Quick Connect Terminal, 10 A, Suitable for appliances with protection class I	6600-3
4787, Mounting: Screw-on mounting, Appliance Outlet: IEC Solder terminals, 10 A, Suitable for appliances with protection class I	4787
4788, Mounting: Snap-in version, Appliance Outlet: IEC Solder/Quick Connect Terminal, 10 A, Suitable for appliances with protection class I	4788
6600-4, Mounting: Snap-in version, Appliance Outlet: IEC F, Solder/Quick Connect Terminal, 10 A, Suitable for appliances with protection class I	6600-4

[Appliance Outlet shuttered Overview complete](#)



4721, Mounting: Screw-on mounting, Appliance Outlet: IEC F, Solder/Quick Connect Terminal, 10 A, Suitable for appliances with protection class I	4721
4723, Mounting: Snap-in version, Appliance Outlet: IEC F, Solder/Quick Connect Terminal, 10 A, Suitable for appliances with protection class I	4723

[Connector Overview complete](#)



4782 Mounting: Power Cord, 3 x 1 mm ² / 3 x 18 AWG, Cable, Connector: IEC C13	4782
4785 Mounting: Power Cord, 3 x 1 mm ² / 3 x 18 AWG, Cable, Connector: IEC C13	4785
4300-06 Mounting: Power Cord, 3 x 1 mm ² / 3 x 18 AWG, Cable, Connector: IEC C13	4300-06
4781 Mounting: Power Cord, Cable, Connector: IEC C15	4781
4784 Mounting: Power Cord, 3 x 1 mm ² / 3 x 18 AWG, Cable, Connector: IEC C15	4784
...	...

[Distribution Unit Overview complete](#)



4751, Mounting: Snap-in, Front Side, Solder pin or quick connect terminals 6.3 x 0.8 or 4.8 x 0.8 mm, x Appliance Outlet: IEC F	4751
0712-PQ, Mounting: Snap-in, Front Side, Solder terminal (4.8 x 0.8 mm), 1x Appliance Outlet: IEC F	0712
4741, Mounting: 2x Appliance Outlet: IEC F	4741
0909, Mounting: Snap-in, Front Side, Solder terminals, 7x Appliance Outlet: IEC F	0909
4752, Mounting: Snap-in, Front Side, Solder/Quick Connect Terminal, 4x Appliance Outlet: IEC F	4752
...	...

[Power Entry Module Overview complete](#)



IEC Appliance Inlet C14 with Appliance Outlet F	KP (Outlet)
Felcom 64, Mounting: 0 mm, Fuseholder: Solder terminals 3.5 x 0.8 mm or quick connect terminals 6.3 x 0.8 mm, Rocker switch: 2-pole non-illuminated, Appliance Inlet: IEC C14, Power Entry Module	Felcom 64
4719, Mounting: Snap-in, mm, Fuseholder: 1-pole, Appliance Outlet: IEC F, with or without neon indicator, Suitable for appliances with protection class I	4719

[Power Entry Module with line filter Overview complete](#)



Felcom 54, Mounting: mm, Front Side, Filter: Standard version, Fuseholder: 1-/2-pole, Front Side, 10 A, Rocker switch: 2-pole, Solder terminals 3.5 x 0.8 mm or quick connect terminals 6.3 x 0.8 mm, Appliance Inlet: IEC C14	Felcom 54
--	-----------

Mouser Electronics

Authorized Distributor

Click to View Pricing, Inventory, Delivery & Lifecycle Information:

[Schurter:](#)

[4300.0401](#)