

**DIMENSIONS: mm.**

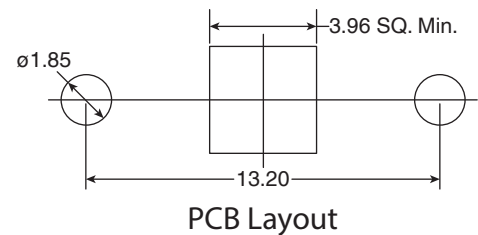
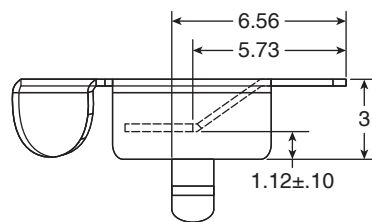
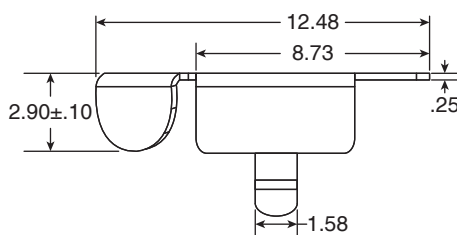
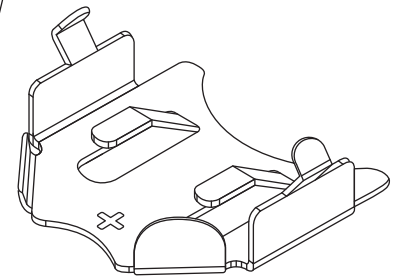
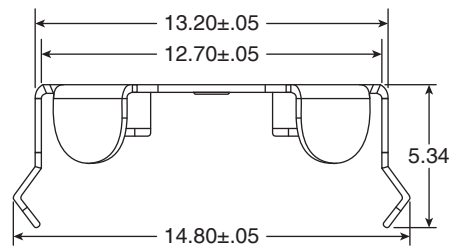
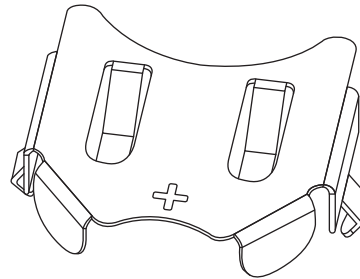
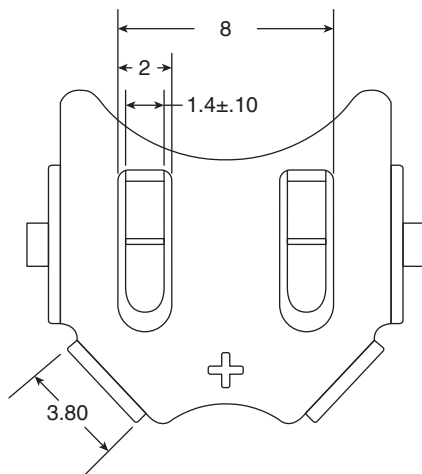

## SPECIFICATIONS

<b>Material:</b>	.25mm Phosphor Bronze Nickel Plated
<b>Battery Size:</b>	CR1216, CR1220, and CR1225
RoHS Compliant	

# Mouser Electronics

Authorized Distributor

Click to View Pricing, Inventory, Delivery & Lifecycle Information:

[Eagle Plastic Devices:](#)

[12BH062-GR](#)