



Is Now Part of



ON Semiconductor®

To learn more about ON Semiconductor, please visit our website at
www.onsemi.com

Please note: As part of the Fairchild Semiconductor integration, some of the Fairchild orderable part numbers will need to change in order to meet ON Semiconductor's system requirements. Since the ON Semiconductor product management systems do not have the ability to manage part nomenclature that utilizes an underscore (_), the underscore (_) in the Fairchild part numbers will be changed to a dash (-). This document may contain device numbers with an underscore (_). Please check the ON Semiconductor website to verify the updated device numbers. The most current and up-to-date ordering information can be found at www.onsemi.com. Please email any questions regarding the system integration to Fairchild_questions@onsemi.com.

ON Semiconductor and the ON Semiconductor logo are trademarks of Semiconductor Components Industries, LLC dba ON Semiconductor or its subsidiaries in the United States and/or other countries. ON Semiconductor owns the rights to a number of patents, trademarks, copyrights, trade secrets, and other intellectual property. A listing of ON Semiconductor's product/patent coverage may be accessed at www.onsemi.com/site/pdf/Patent-Marking.pdf. ON Semiconductor reserves the right to make changes without further notice to any products herein. ON Semiconductor makes no warranty, representation or guarantee regarding the suitability of its products for any particular purpose, nor does ON Semiconductor assume any liability arising out of the application or use of any product or circuit, and specifically disclaims any and all liability, including without limitation special, consequential or incidental damages. Buyer is responsible for its products and applications using ON Semiconductor products, including compliance with all laws, regulations and safety requirements or standards, regardless of any support or applications information provided by ON Semiconductor. "Typical" parameters which may be provided in ON Semiconductor data sheets and/or specifications can and do vary in different applications and actual performance may vary over time. All operating parameters, including "Typicals" must be validated for each customer application by customer's technical experts. ON Semiconductor does not convey any license under its patent rights nor the rights of others. ON Semiconductor products are not designed, intended, or authorized for use as a critical component in life support systems or any FDA Class 3 medical devices or medical devices with a same or similar classification in a foreign jurisdiction or any devices intended for implantation in the human body. Should Buyer purchase or use ON Semiconductor products for any such unintended or unauthorized application, Buyer shall indemnify and hold ON Semiconductor and its officers, employees, subsidiaries, affiliates, and distributors harmless against all claims, costs, damages, and expenses, and reasonable attorney fees arising out of, directly or indirectly, any claim of personal injury or death associated with such unintended or unauthorized use, even if such claim alleges that ON Semiconductor was negligent regarding the design or manufacture of the part. ON Semiconductor is an Equal Opportunity/Affirmative Action Employer. This literature is subject to all applicable copyright laws and is not for resale in any manner.

74VCX08

Low Voltage Quad 2-Input AND Gate with 3.6V Tolerant Inputs and Outputs

Features

- 1.2V to 3.6V V_{CC} supply operation
- 3.6V tolerant inputs and outputs
- t_{PD} :
 - 2.8ns max. for 3.0V to 3.6V V_{CC}
- Power-off high impedance inputs and outputs
- Static Drive (I_{OH}/I_{OL})
 - $\pm 24mA$ @ 3.0V V_{CC}
- Uses proprietary Quiet Series™ noise/EMI reduction circuitry
- Latchup performance exceeds 300mA
- ESD performance:
 - Human body model > 2000V
 - Machine model > 250V
- Leadless DQFN package

General Description

The VCX08 contains four 2-input AND gates. This product is designed for low voltage (1.2V to 3.6V) V_{CC} applications with I/O compatibility up to 3.6V.

The VCX08 is fabricated with an advanced CMOS technology to achieve high-speed operation while maintaining low CMOS power dissipation.

Ordering Information

Order Number	Package Number	Package Description
74VCX08M	M14A	14-Lead Small Outline Integrated Circuit (SOIC), JEDEC MS-012, 0.150" Narrow
74VCX08BQX ⁽¹⁾	MLP14A	14-Terminal Depopulated Quad Very-Thin Flat Pack No Leads (DQFN), JEDEC MO-241, 2.5 x 3.0mm
74VCX08MTC	MTC14	14-Lead Thin Shrink Small Outline Package (TSSOP), JEDEC MO-153, 4.4mm Wide

Note:

1. DQFN package available in Tape and Reel only.

Device also available in Tape and Reel. Specify by appending suffix letter "X" to the ordering number.

 All packages are lead free per JEDEC: J-STD-020B standard.

Connection Diagrams

Pin Assignments for SOIC and TSSOP

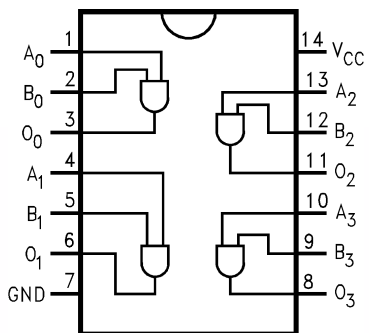

Pad Assignments for DQFN

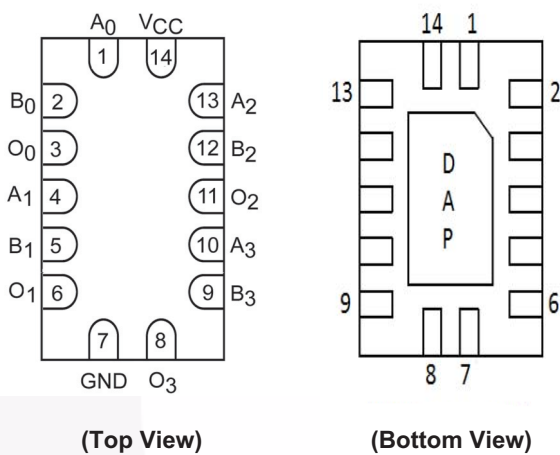

Logic Symbol

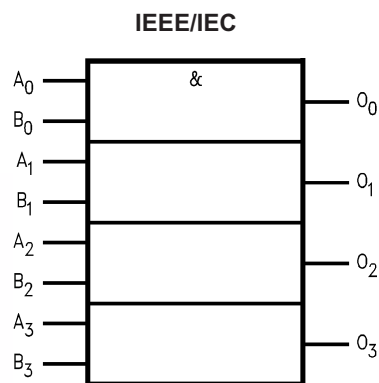

Pin Description

Pin Names	Description
A_n, B_n	Inputs
O_n	Outputs
DAP	No Connect

Note: DAP (Die Attach Pad)

Absolute Maximum Ratings

Stresses exceeding the absolute maximum ratings may damage the device. The device may not function or be operable above the recommended operating conditions and stressing the parts to these levels is not recommended. In addition, extended exposure to stresses above the recommended operating conditions may affect device reliability. The absolute maximum ratings are stress ratings only.

Symbol	Parameter	Rating
V_{CC}	Supply Voltage	-0.5V to +4.6V
V_I	DC Input Voltage	-0.5V to 4.6V
V_O	DC Output Voltage HIGH or LOW State ⁽²⁾	-0.5V to $V_{CC}+0.5V$
	$V_{CC} = 0V$	-0.5V to +4.6V
I_{IK}	DC Input Diode Current, $V_I < 0V$	-50mA
I_{OK}	DC Output Diode Current $V_O < 0V$	-50mA
	$V_O > V_{CC}$	+50mA
I_{OH} / I_{OL}	DC Output Source/Sink Current	+50mA
I_{CC} or GND	DC V_{CC} or Ground Current per Supply Pin	$\pm 100mA$
T_{STG}	Storage Temperature Range	-65°C to +150°C

Note:

2. I_O Absolute Maximum Rating must be observed.

Recommended Operating Conditions⁽³⁾

The Recommended Operating Conditions table defines the conditions for actual device operation. Recommended operating conditions are specified to ensure optimal performance to the datasheet specifications. Fairchild does not recommend exceeding them or designing to absolute maximum ratings.

Symbol	Parameter	Rating
V_{CC}	Power Supply Operating	1.2V to 3.6V
V_I	Input Voltage	-0.3V to 3.6V
V_O	Output Voltage, HIGH or LOW State	0V to V_{CC}
I_{OH} / I_{OL}	Output Current $V_{CC} = 3.0V$ to 3.6V	$\pm 24mA$
	$V_{CC} = 2.3V$ to 2.7V	$\pm 18mA$
	$V_{CC} = 1.65V$ to 2.3V	$\pm 6mA$
	$V_{CC} = 1.4V$ to 1.6V	$\pm 2mA$
	$V_{CC} = 1.2V$	$\pm 100\mu A$
T_A	Free Air Operating Temperature	-40°C to +85°C
$\Delta t / \Delta V$	Minimum Input Edge Rate, $V_{IN} = 0.8V$ to 2.0V, $V_{CC} = 3.0V$	10ns/V

Note:

3. Floating or unused inputs must be held HIGH or LOW

DC Electrical Characteristics

Symbol	Parameter	V _{CC} (V)	Conditions	Min	Max	Units
V _{IH}	HIGH Level Input Voltage	2.7–3.6		2.0		V
		2.3–2.7		1.6		
		1.65–2.3		0.65 × V _{CC}		
		1.4–1.6		0.65 × V _{CC}		
		1.2		0.65 × V _{CC}		
V _{IL}	LOW Level Input Voltage	2.7–3.6			0.8	V
		2.3–2.7			0.7	
		1.65–2.3			0.35 × V _{CC}	
		1.4–1.6			0.35 × V _{CC}	
		1.2			0.05 × V _{CC}	
V _{OH}	HIGH Level Output Voltage	2.7–3.6	I _{OH} = –100μA	V _{CC} – 0.2		V
		2.7	I _{OH} = –12mA	2.2		
		3.0	I _{OH} = –18mA	2.4		
		3.0	I _{OH} = –24mA	2.2		
		2.3–2.7	I _{OH} = –100μA	V _{CC} – 0.2		
		2.3	I _{OH} = –6mA	2.0		
		2.3	I _{OH} = –12mA	1.8		
		2.3	I _{OH} = –18mA	1.7		
		1.65–2.3	I _{OH} = –100μA	V _{CC} – 0.2		
		1.65	I _{OH} = –6mA	1.25		
		1.4–1.6	I _{OH} = –100μA	V _{CC} – 0.2		
		1.4	I _{OH} = –2mA	1.05		
		1.2	I _{OH} = –100μA	V _{CC} – 0.2		
V _{OL}	LOW Level Output Voltage	2.7–3.6	I _{OL} = 100μA		0.2	V
		2.7	I _{OL} = 12mA		0.4	
		3.0	I _{OL} = 18mA		0.4	
		3.0	I _{OL} = 24mA		0.55	
		2.3–2.7	I _{OL} = 100μA		0.2	
		2.3	I _{OL} = 12mA		0.4	
		2.3	I _{OL} = 18mA		0.6	
		1.65–2.3	I _{OL} = 100μA		0.2	
		1.65	I _{OL} = 6mA		0.2	
		1.4–1.6	I _{OL} = 100μA		0.2	
		1.4	I _{OL} = 2mA		0.35	
		1.2	I _{OL} = 100μA		0.05	
		I _I	Input Leakage Current	1.2–3.6	0 ≤ V _I ≤ 3.6V	
I _{OFF}	Power-OFF Leakage Current	0	0 ≤ (V _I , V _O) ≤ 3.6V		10	μA
I _{CC}	Quiescent Supply Current	1.2–3.6	V _I = V _{CC} or GND		20	μA
			V _{CC} ≤ V _I ≤ 3.6V		±20	
ΔI _{CC}	Increase in I _{CC} per Input	2.7–3.6	V _{IH} = V _{CC} – 0.6V		750	μA

AC Electrical Characteristics⁽⁴⁾

Symbol	Parameter	V _{CC} (V)	Conditions	T _A = -40°C to +85°C		Units	Figure Number
				Min.	Max.		
t _{PHL} , t _{PLH}	Propagation Delay	3.3 ± 0.3	C _L = 30pF, R _L = 500Ω	0.6	2.8	ns	Fig. 1 Fig. 2
		2.5 ± 0.2		0.8	3.7		
		1.8 ± 0.15		1.0	7.4		
		1.5 ± 0.1	C _L = 15pF, R _L = 2kΩ	1.0	14.8		Fig. 3 Fig. 4
		1.2		1.5	37.0		
t _{OSSL} , t _{OSLH}	Output to Output Skew ⁽⁵⁾	3.3 ± 0.3	C _L = 30pF, R _L = 500Ω		0.5	ns	
		2.5 ± 0.2			0.5		
		1.8 ± 0.15			0.75		
		1.5 ± 0.1	C _L = 15pF, R _L = 2kΩ		1.5		
		1.2			1.5		

Note:

- For C_L = 50pF, add approximately 300ps to the AC Maximum specification.
- Skew is defined as the absolute value of the difference between the actual propagation delay for any two separate outputs of the same device. The specification applies to any outputs switching in the same direction, either HIGH-to-LOW (t_{OSSL}) or LOW-to-HIGH (t_{OSLH}).

Dynamic Switching Characteristics

Symbol	Parameter	V _{CC} (V)	Conditions	T _A = 25°C	Unit
				Typical	
V _{OLP}	Quiet Output Dynamic Peak V _{OL}	1.8	C _L = 30pF, V _{IH} = V _{CC} , V _{IL} = 0V	0.25	V
		2.5		0.6	
		3.3		0.8	
V _{OLV}	Quiet Output Dynamic Valley V _{OL}	1.8	C _L = 30pF, V _{IH} = V _{CC} , V _{IL} = 0V	-0.25	V
		2.5		-0.6	
		3.3		-0.8	
V _{OHV}	Quiet Output Dynamic Valley V _{OH}	1.8	C _L = 30pF, V _{IH} = V _{CC} , V _{IL} = 0V	1.5	V
		2.5		1.9	
		3.3		2.2	

Capacitance

Symbol	Parameter	Conditions	T _A = +25°C	Units
			Typical	
C _{IN}	Input Capacitance	V _I = 0V or V _{CC} , V _{CC} = 1.8V, 2.5V or 3.3V	6.0	pF
C _{OUT}	Output Capacitance	V _I = 0V or V _{CC} , V _{CC} = 1.8V, 2.5V or 3.3V	7.0	pF
C _{PD}	Power Dissipation Capacitance	V _I = 0V or V _{CC} , f = 10MHz, V _{CC} = 1.8V, 2.5V or 3.3V	20.0	pF

AC Loading and Waveforms (V_{CC} 3.3V \pm 0.3V to 1.8V \pm 0.15V)

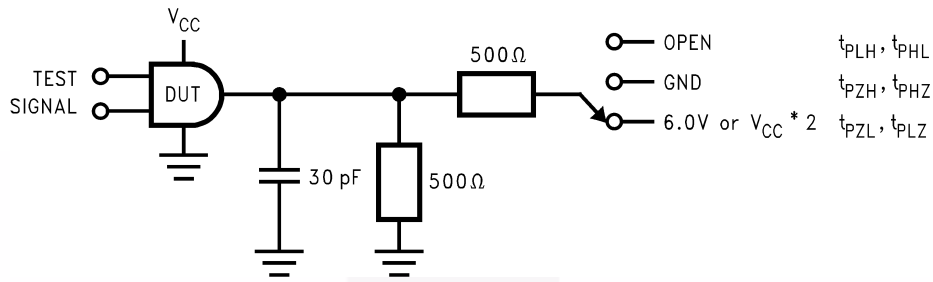

Test	Switch
t_{PLH} , t_{PHL}	Open

Figure 1. AC Test Circuit

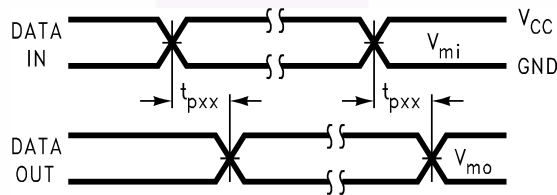

Symbol	V_{CC}		
	3.3V \pm 0.3V	2.5V \pm 0.2V	1.8V \pm 0.15V
V_{mi}	1.5V	$V_{CC} / 2$	$V_{CC} / 2$
V_{mo}	1.5V	$V_{CC} / 2$	$V_{CC} / 2$

Figure 2. Waveform for Inverting and Non-inverting Functions

AC Loading and Waveforms ($V_{CC} 1.5 \pm 0.1V$ to $1.2V$)

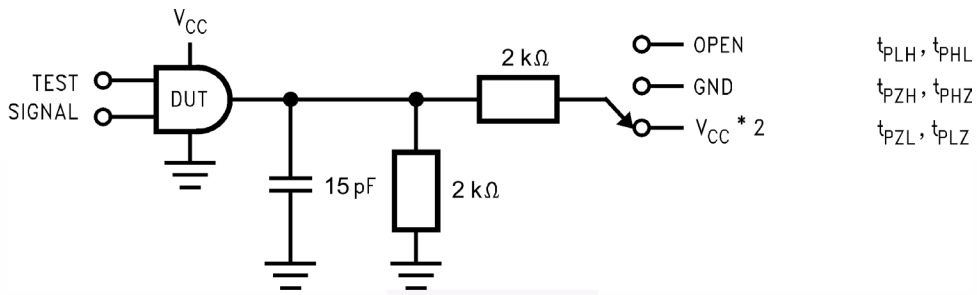

Test	Switch
t_{PLH}, t_{PHL}	Open
t_{PZL}, t_{PLZ}	$V_{CC} \times 2$ at $V_{CC} = 1.5V \pm 0.1V$
t_{PZH}, t_{PHZ}	GND

Figure 3. AC Test Circuit

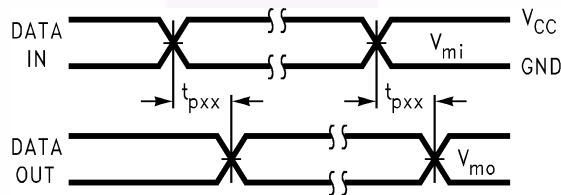

Symbol	V_{CC}
	V_{mi}
V_{mo}	$V_{CC} / 2$

Figure 4. Waveform for Inverting and Non-Inverting Functions

Tape and Reel Specification

Tape Format for DQFN

Package Designator	Tape Section	Number of Cavities	Cavity Status	Cover Tape Status
BQX	Leader (Start End)	125 (Typ.)	Empty	Sealed
	Carrier	3000	Filled	Sealed
	Trailer (Hub End)	75 (Typ.)	Empty	Sealed

Tape Dimensions inches (millimeters)



PKG. SIZE	DIM.Ao	DIM.Bo	DIM.Ko
3.5 X 4.5	3.8 ± 0.1	4.8 ± 0.1	0.9 ± 0.1
3.0 X 3.0	3.3 ± 0.1	3.3 ± 0.1	0.9 ± 0.1
2.5 X 4.5	2.8 ± 0.1	4.8 ± 0.1	0.9 ± 0.1
2.5 X 3.5	2.8 ± 0.1	3.8 ± 0.1	0.9 ± 0.1
2.5 X 3.0	2.8 ± 0.1	3.3 ± 0.1	0.9 ± 0.1
2.5 X 2.5	2.8 ± 0.1	2.8 ± 0.1	0.9 ± 0.1

DIMENSIONS ARE IN MILLIMETERS

NOTES: unless otherwise specified

1. Cumulative pitch for feeding holes and cavities (chip pockets) not to exceed 0.008[0.20] over 10 pitch span.
2. Smallest allowable bending radius.
3. Thru hole inside cavity is centered within cavity.
4. Tolerance is $\pm 0.002[0.05]$ for these dimensions on all 12mm tapes.
5. Ao and Bo measured on a plane 0.120[0.30] above the bottom of the pocket.
6. Ko measured from a plane on the inside bottom of the pocket to the top surface of the carrier.
7. Pocket position relative to sprocket hole measured as true position of pocket. Not pocket hole.
8. Controlling dimension is millimeter. Dimension in inches rounded.

Reel Dimensions inches (millimeters)



Tape Size	A	B	C	D	N	W1	W2
12mm	13.0 (330.0)	0.059 (1.50)	0.512 (13.00)	0.795 (20.20)	2.165 (55.00)	0.488 (12.4)	0.724 (18.4)

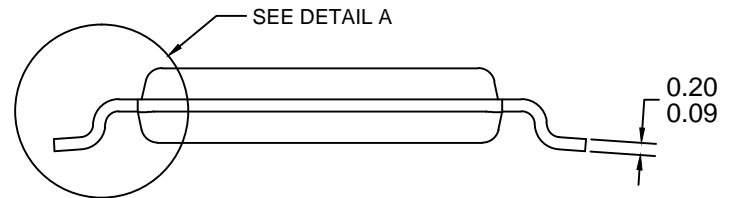

NOTES:

- A. CONFORMS TO JEDEC REGISTRATION MO-153, VARIATION AB, REF NOTE 6
- B. DIMENSIONS ARE IN MILLIMETERS.
- C. DIMENSIONS ARE EXCLUSIVE OF BURRS, MOLD FLASH, AND TIE BAR EXTRUSIONS
- D. DIMENSIONING AND TOLERANCES PER ANSI Y14.5M, 2009.
- E. LANDPATTERN STANDARD: SOP65P640X110-14M.
- F. DRAWING FILE NAME: MKT-MTC14rev7.



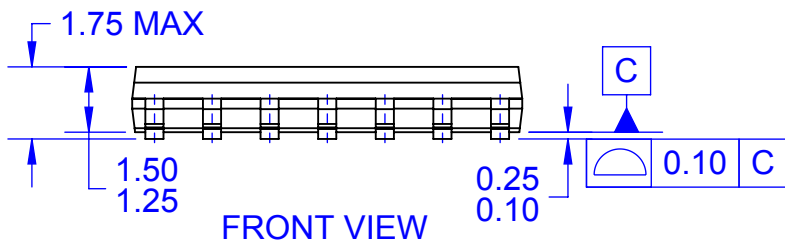
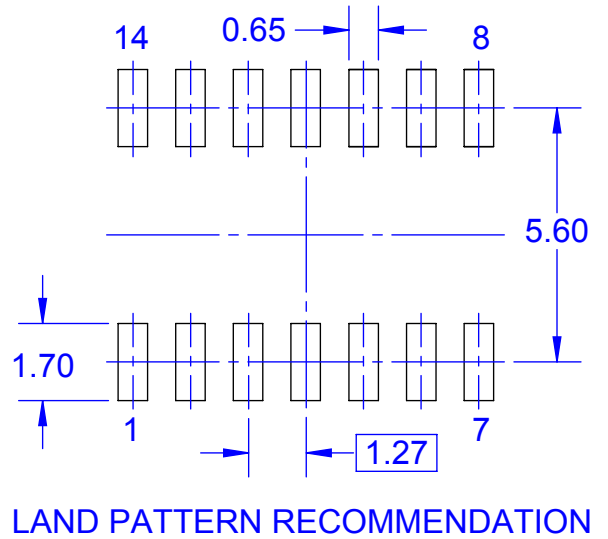
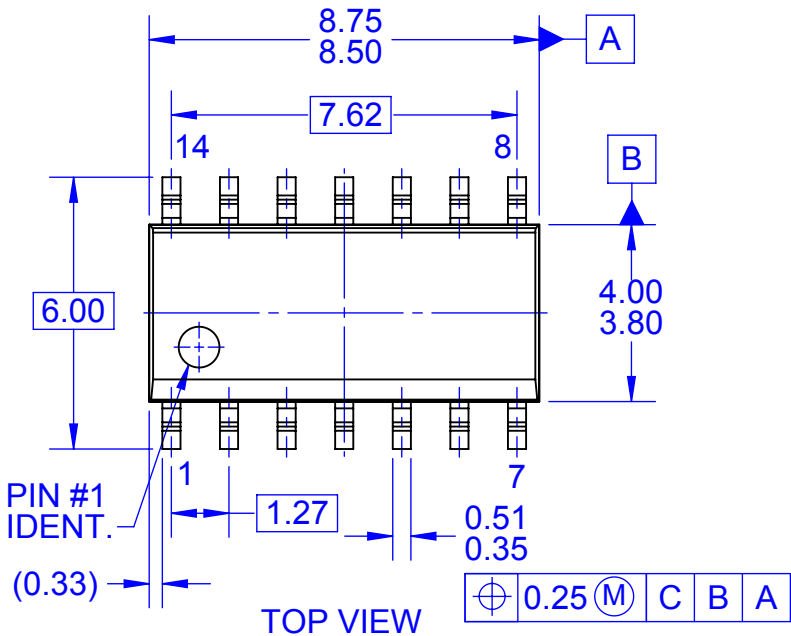

NOTES:

- A. CONFORMS TO JEDEC MS-012, VARIATION AB, ISSUE C
- B. ALL DIMENSIONS ARE IN MILLIMETERS
- C. DIMENSIONS DO NOT INCLUDE MOLD FLASH OR BURRS
- D. LAND PATTERN STANDARD: SOIC127P600X145-14M
- E. CONFORMS TO ASME Y14.5M, 2009
- D. DRAWING FILENAME: MKT-M14Arev14





RECOMMENDED LAND PATTERN

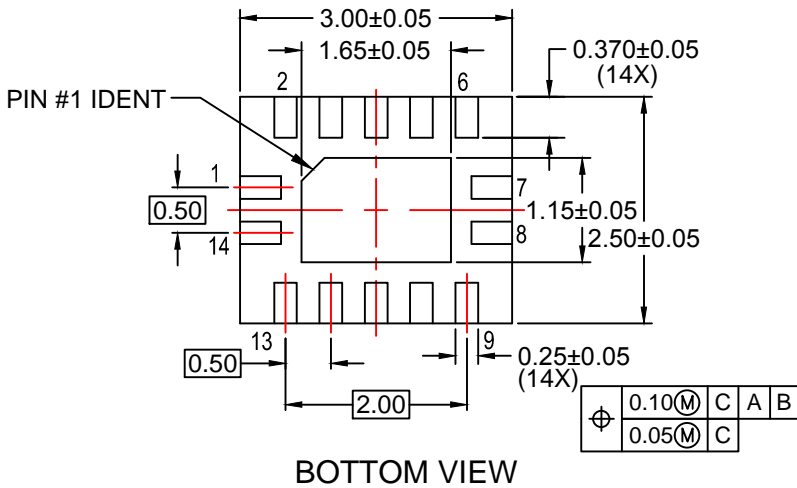
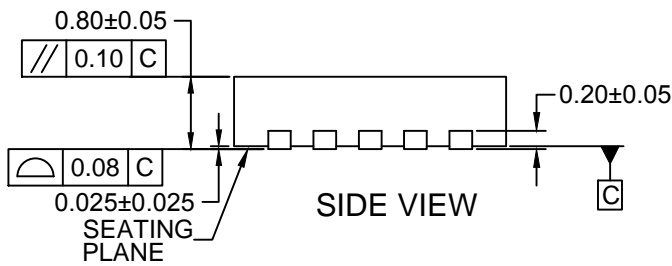

NOTES:

- A. CONFORMS TO JEDEC REGISTRATION MO-241, VARIATION AA
- B. DIMENSIONS ARE IN MILLIMETERS.
- C. DIMENSIONS AND TOLERANCES PER ASME Y14.5M, 2009.
- D. LAND PATTERN RECOMMENDATION IS EXISTING INDUSTRY LAND PATTERN.
- E. DRAWING FILENAME: MKT-MLP14Arev2.



ON Semiconductor and  are trademarks of Semiconductor Components Industries, LLC dba ON Semiconductor or its subsidiaries in the United States and/or other countries. ON Semiconductor owns the rights to a number of patents, trademarks, copyrights, trade secrets, and other intellectual property. A listing of ON Semiconductor's product/patent coverage may be accessed at www.onsemi.com/site/pdf/Patent-Marking.pdf. ON Semiconductor reserves the right to make changes without further notice to any products herein. ON Semiconductor makes no warranty, representation or guarantee regarding the suitability of its products for any particular purpose, nor does ON Semiconductor assume any liability arising out of the application or use of any product or circuit, and specifically disclaims any and all liability, including without limitation special, consequential or incidental damages. Buyer is responsible for its products and applications using ON Semiconductor products, including compliance with all laws, regulations and safety requirements or standards, regardless of any support or applications information provided by ON Semiconductor. "Typical" parameters which may be provided in ON Semiconductor data sheets and/or specifications can and do vary in different applications and actual performance may vary over time. All operating parameters, including "Typicals" must be validated for each customer application by customer's technical experts. ON Semiconductor does not convey any license under its patent rights nor the rights of others. ON Semiconductor products are not designed, intended, or authorized for use as a critical component in life support systems or any FDA Class 3 medical devices or medical devices with a same or similar classification in a foreign jurisdiction or any devices intended for implantation in the human body. Should Buyer purchase or use ON Semiconductor products for any such unintended or unauthorized application, Buyer shall indemnify and hold ON Semiconductor and its officers, employees, subsidiaries, affiliates, and distributors harmless against all claims, costs, damages, and expenses, and reasonable attorney fees arising out of, directly or indirectly, any claim of personal injury or death associated with such unintended or unauthorized use, even if such claim alleges that ON Semiconductor was negligent regarding the design or manufacture of the part. ON Semiconductor is an Equal Opportunity/Affirmative Action Employer. This literature is subject to all applicable copyright laws and is not for resale in any manner.

PUBLICATION ORDERING INFORMATION

LITERATURE FULFILLMENT:

Literature Distribution Center for ON Semiconductor
19521 E. 32nd Pkwy, Aurora, Colorado 80011 USA
Phone: 303-675-2175 or 800-344-3860 Toll Free USA/Canada
Fax: 303-675-2176 or 800-344-3867 Toll Free USA/Canada
Email: orderlit@onsemi.com

N. American Technical Support: 800-282-9855 Toll Free
USA/Canada
Europe, Middle East and Africa Technical Support:
Phone: 421 33 790 2910
Japan Customer Focus Center
Phone: 81-3-5817-1050

ON Semiconductor Website: www.onsemi.com
Order Literature: <http://www.onsemi.com/orderlit>
For additional information, please contact your local
Sales Representative

Mouser Electronics

Authorized Distributor

Click to View Pricing, Inventory, Delivery & Lifecycle Information:

[ON Semiconductor:](#)

[74VCX08MTCX](#) [74VCX08M](#) [74VCX08MX](#) [74VCX08BQX](#) [74VCX08MTC](#)