

REV.	DESCRIPTION	DRAWN	CHECKED	APPROVED

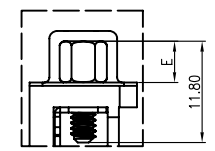

WITH SCREW TYPE

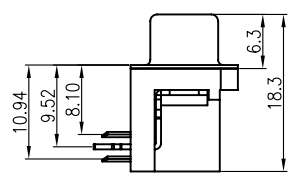
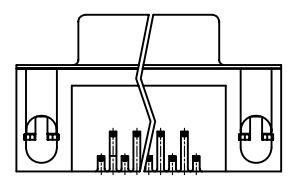
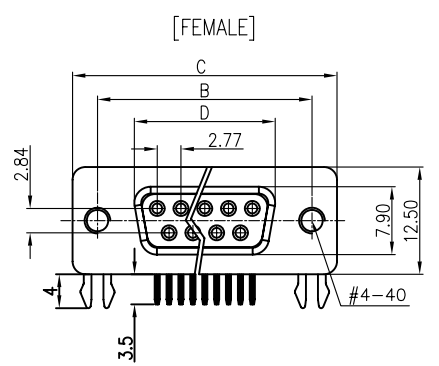
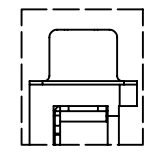

WITH RIVET TYPE

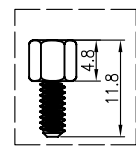

SCREWS

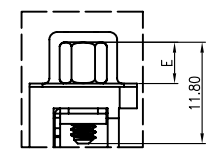

WITH SCREW AND RIVET TYPE

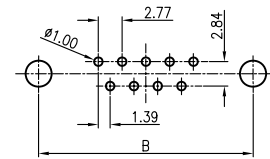
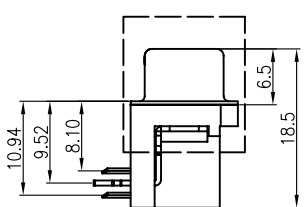

RECOMMEND PCB LAYOUT(TOLERANCE ±0.05)
(VIEW FROM TOP SIDE)

NOTES:

- PRODUCTS PERFORMANCE:
 - VOLTAGE RATING: 250V AC.
 - CONTACT CURRENT RATING: 1.5A MAX. PER PIN.
 - CONTACT RESISTANCE: 20mΩ MAX.
 - DIELECTRIC WITHSTANDING VOLTAGE: 500V AC(rms) FOR 1 MINUTE.
 - INSULATION RESISTANCE: 1000MΩ MINI.
 - OPERATING TEMPERATURE: -20°C~+70°C.
- PRODUCT NUMBER CODE:

DS1037 - X X X X X X X X

- SCREW DIM. E
 - 4: 4.80mm
 - 5: 5.80mm
- BOARD LOCK DIM. F
 - 4: 4.00mm
 - 7: 3.70mm
- CONTACT PLATING
 - T: SELECTIVE GOLD FLASH
 - Si: FULL GOLD FLASH
- COLOR OF HOUSING
 - K: BLACK
 - B: BLUE
- SCREW TYPE
 - A: WITH SCREW TYPE
 - B: WITH RIVET TYPE
 - C: WITH SCREW AND RIVET TYPE
 - D: RIVET TYPE WITH SCREWS IN BULK PACKAGE
- SHELL PLATING
 - N: Nickel
 - T: Tin
- CONNECTOR TYPE
 - M: MALE
 - F: FEMALE
- No. OF CONTACT
 - 09: 9pos.
 - 15: 15pos.
 - 25: 25pos.
 - 37: 37pos.

Dimension

Position	A±0.2	B±0.2	C±0.2	D
9	17.90	24.99	30.84	16.33
15	26.50	33.32	39.14	24.66
25	40.00	47.04	53.04	38.38
37	56.50	63.50	69.32	54.84

GENERAL TOLERANCE		ANGLE TOLERANCE		PROJECTION	TITLE
X.	±0.60	X.	±5°		D-SUB RIGHT ANGLE(7.2mm) TYPE
.X	±0.38	.X	±3'	mm	
.XX	±0.25	.XX	±2'	A4	
DRAWING TYPE		CUSTOMER		SHEET SIZE	SERIES
SCALE		1:1		DS1037 SERIES	
DRAWING NO.		C-DS1037-XXXXXXX		DRB-09FA DRB-09MA	
				DRB-15FA DRB-15MA	
				DRB-25FA DRB-25MA	
				DRB-37FA DRB-37MA	