

**N-Channel 80V(D-S) MOSFET**

**GENERAL DESCRIPTION**

The ME80N08A is the N-Channel logic enhancement mode power field effect transistors are produced using high cell density, DMOS trench technology. This high density process is especially tailored to minimize on-state resistance. These devices are particularly suited for low voltage application such as cellular phone and notebook computer power management and other battery powered circuits where high-side switching and low in-line power loss are needed in a very small outline surface mount package.

**FEATURES**

- $R_{DS(ON)} \leq 5m\Omega @ V_{GS}=10V$
- Super high density cell design for extremely low  $R_{DS(ON)}$
- Exceptional on-resistance and maximum DC current capability

**APPLICATIONS**

- Power Management in Note book
- DC/DC Converter
- Load Switch
- LCD Display inverter

**PIN CONFIGURATION**

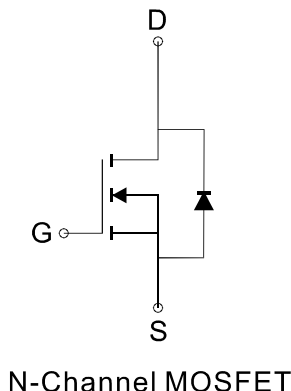
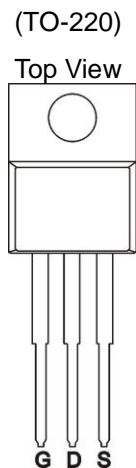

**Ordering Information:** ME80N08A (Pb-free)  
ME80N08A-G (Green product-Halogen free)

**Absolute Maximum Ratings (Tc=25°C Unless Otherwise Noted)**

Parameter	Symbol	Maximum Ratings	Unit
Drain-Source Voltage	V <sub>DS</sub>	80	V
Gate-Source Voltage	V <sub>GS</sub>	±20	V
Continuous Drain Current*	I <sub>D</sub>	T <sub>c</sub> =25°C	194
		T <sub>c</sub> =70°C	162
Pulsed Drain Current <sup>a</sup>	I <sub>DM</sub>	776	A
Power Dissipation	P <sub>D</sub>	T <sub>c</sub> =25°C	300
		T <sub>c</sub> =70°C	210
Junction and Storage Temperature Range	T <sub>J</sub> , T <sub>stg</sub>	-55 to 175	°C
Thermal Resistance-Junction to Case**	R <sub>θJC</sub>	0.5	°C/W

\* Calculated continuous current based on maximum allowable junction temperature. Package limitation current is 80A.

\*\* The device mounted on 1in<sup>2</sup> FR4 board with 2 oz copper.

## N-Channel 80V(D-S) MOSFET

Electrical Characteristics (T<sub>J</sub> = 25°C Unless Otherwise Specified)

Symbol	Parameter	Limit	Min	Typ	Max	Unit
<b>STATIC</b>						
BV <sub>DSS</sub>	Drain-Source Breakdown Voltage	V <sub>GS</sub> =0V, I <sub>D</sub> =250 μA	80			V
V <sub>GS(th)</sub>	Gate Threshold Voltage	V <sub>DS</sub> =V <sub>GS</sub> , I <sub>D</sub> =250 μA	2.0		4.0	V
I <sub>GSS</sub>	Gate-Body Leakage	V <sub>GS</sub> =±20V			±100	nA
I <sub>DSS</sub>	Zero Gate Voltage Drain Current	V <sub>DS</sub> =80V, V <sub>GS</sub> =0V			1	μA
R <sub>DS(ON)</sub>	Drain-Source On-Resistance*	V <sub>GS</sub> =10V, I <sub>D</sub> =80A		3.9	5	mΩ
V <sub>SD</sub>	Diode Forward Voltage *	I <sub>S</sub> =40A, V <sub>GS</sub> =0V		0.8	1.2	V
<b>DYNAMIC</b>						
Q <sub>g</sub>	Total Gate Charge	V <sub>DD</sub> =40V, V <sub>GS</sub> =10V, I <sub>D</sub> =80A		221		nC
Q <sub>g</sub>	Total Gate Charge	V <sub>DD</sub> =40V, V <sub>GS</sub> =4.5V, I <sub>D</sub> =80A		56		
Q <sub>gs</sub>	Gate-Source Charge			63		
Q <sub>gd</sub>	Gate-Drain Charge			55		
C <sub>iss</sub>	Input Capacitance	V <sub>DS</sub> =25V, V <sub>GS</sub> =0V, f=1MHz		12500		pF
C <sub>oss</sub>	Output Capacitance			1150		
C <sub>rss</sub>	Reverse Transfer Capacitance			375		
t <sub>d(on)</sub>	Turn-On Delay Time	V <sub>GS</sub> = 10V, R <sub>L</sub> =20Ω		65		ns
t <sub>r</sub>	Turn-On Rise Time			43		
t <sub>d(off)</sub>	Turn-Off Delay Time	V <sub>DD</sub> =40V, R <sub>G</sub> =3.3Ω		196		
t <sub>f</sub>	Turn-Off Fall Time			53		

Notes: a. pulse test: pulse width ≤ 300us, duty cycle ≤ 2%, Guaranteed by design, not subject to production testing.

b. Matsuki Electric/ Force mos reserves the right to improve product design, functions and reliability without notice.

DCC  
正式發行

**N-Channel 80V(D-S) MOSFET**

**Typical Characteristics (T<sub>J</sub> =25°C Noted)**

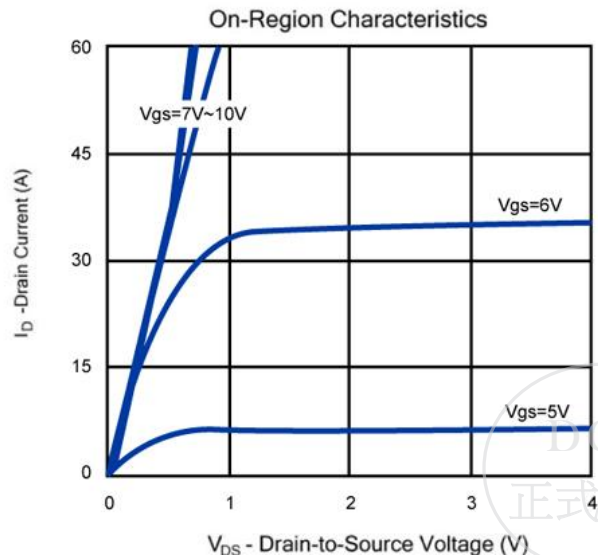
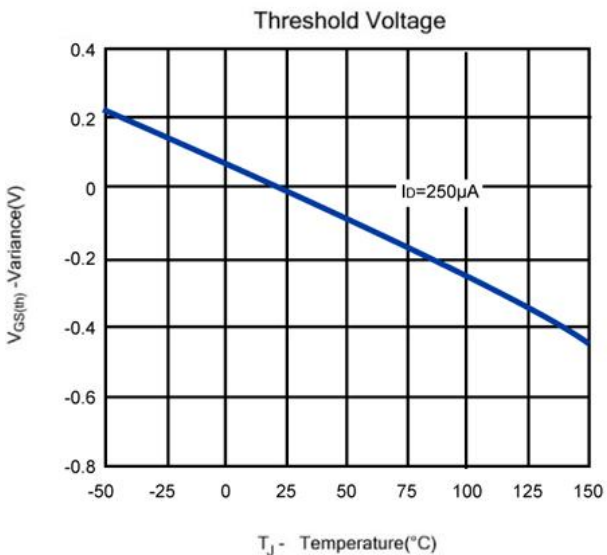
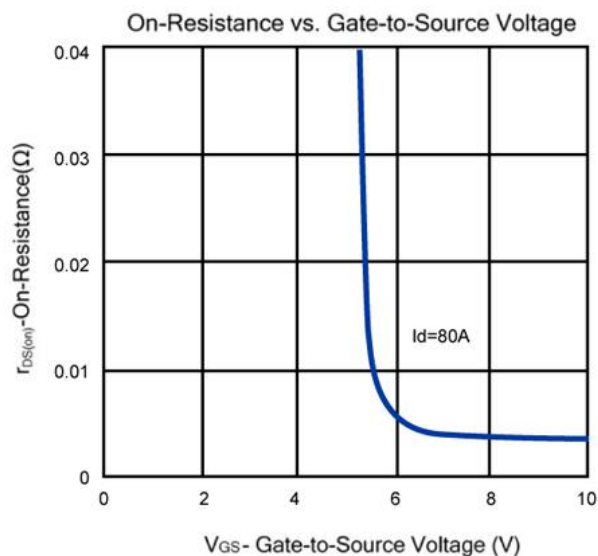
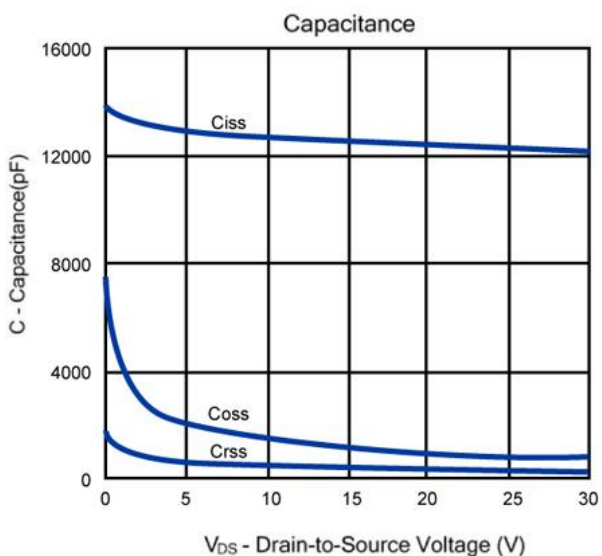
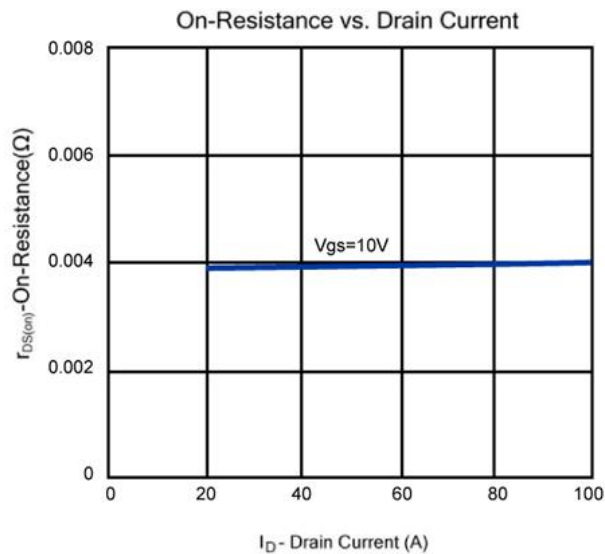
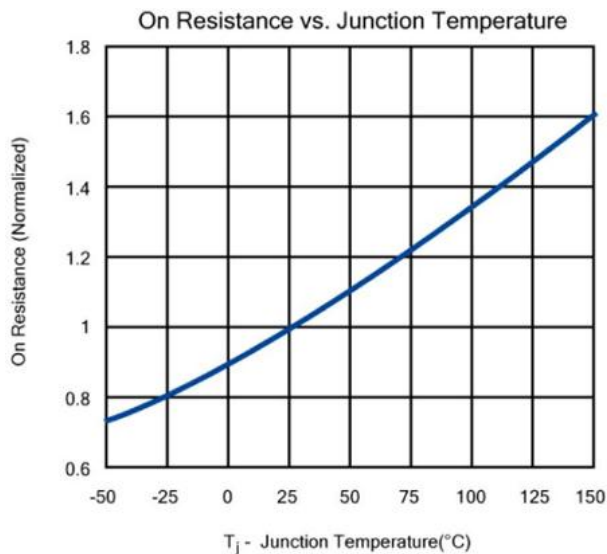

**N-Channel 80V(D-S) MOSFET**

**Typical Characteristics (T<sub>J</sub> =25°C Noted)**

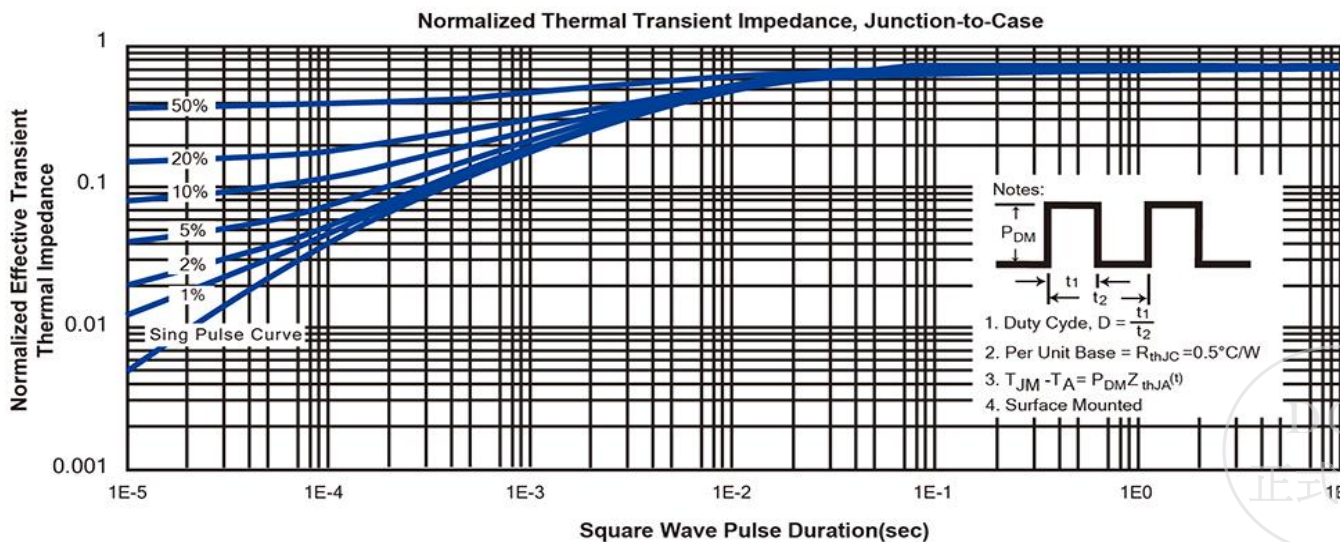
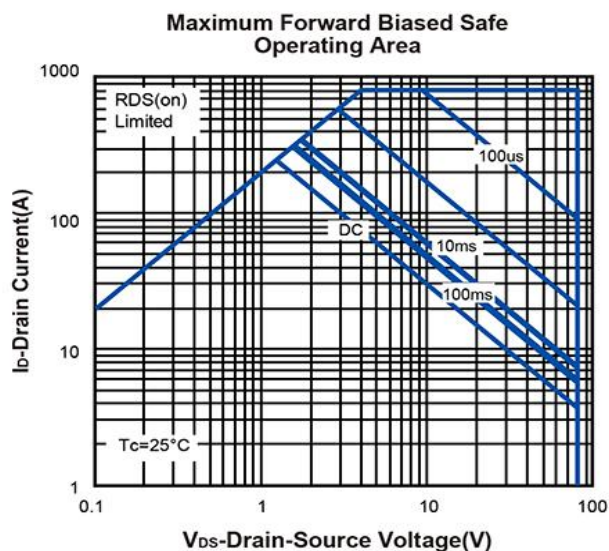
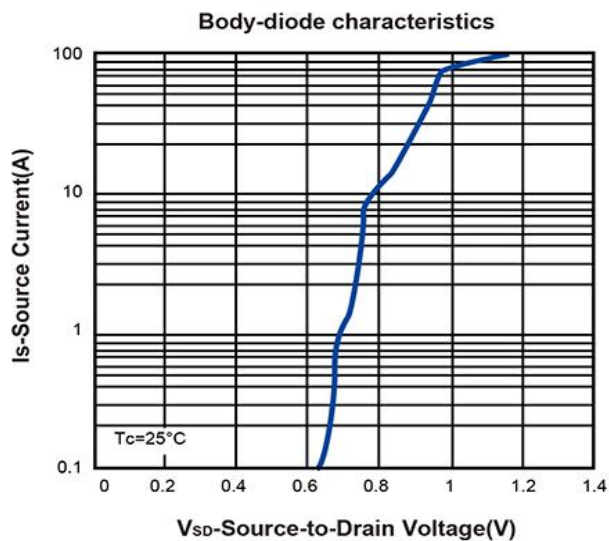
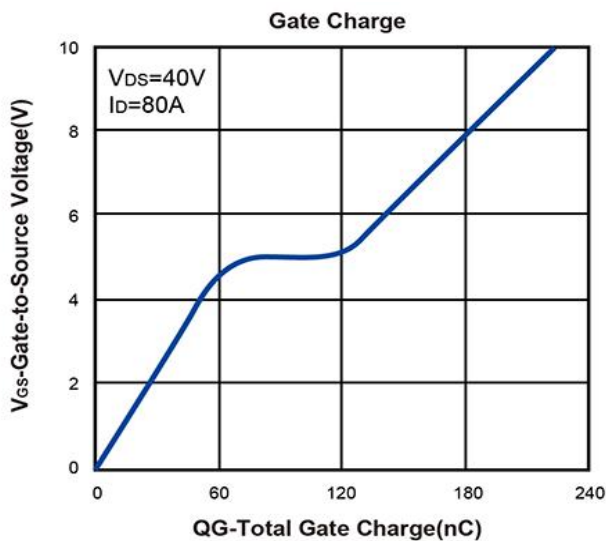

**TO-220 Package Outline**

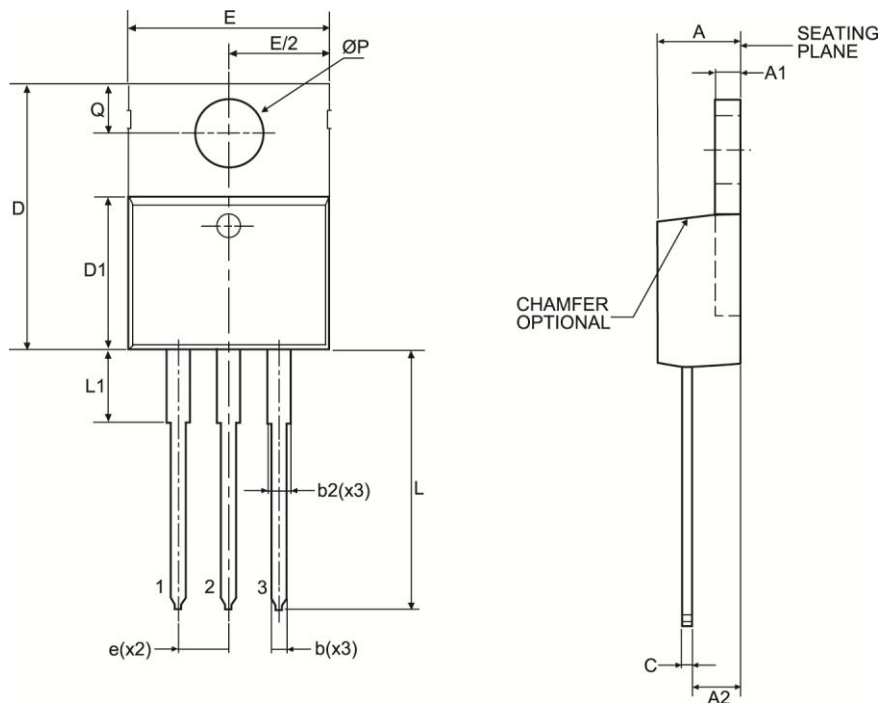

Symbol	MILLIMETERS (mm)	
	MIN	MAX
A	3.50	4.90
A1	1.00	1.40
A2	2.00	3.00
b	0.70	1.40
c	0.35	0.65
D	14.00	16.50
D1	8.30	9.50
E	9.60	10.70
e	2.54 BSC	
L	12.50	15.00
ØP	3.60 TYP	
Q	2.50	3.10
b2	1.10	1.80
L1	2.40	3.20

