



Typical Applications

This amplifier is ideal for high linearity applications:

- Multi-Carrier Systems
- GSM, GPRS & EDGE
- CDMA & WCDMA
- PHS

Features

- Output IP3: +42 dBm
- Gain: 13 dB
- 56% PAE @ +28 dBm Pout
- +19 dBm W-CDMA Channel Power @ -45 dBc ACP
- 3x3 mm QFN SMT Package

Functional Diagram

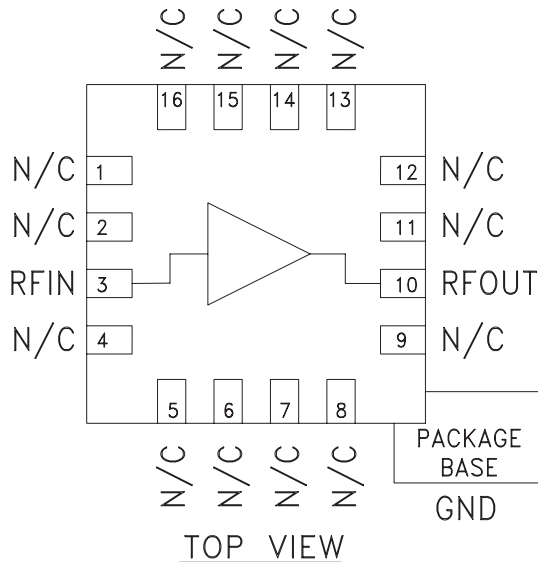

General Description

The HMC455LP3 & HMC455LP3E are high output IP3 GaAs InGaP Heterojunction Bipolar Transistor (HBT) 1/2 watt MMIC amplifiers operating between 1.7 and 2.5 GHz. Utilizing a minimum number of external components the amplifier provides 13 dB of gain and +28 dBm of saturated power at 56% PAE from a single +5 Vdc supply voltage. The high output IP3 of +42 dBm coupled with the low VSWR of 1.4:1 make the HMC455LP3 & HMC455LP3E ideal driver amplifiers for PCS/3G wireless infrastructures. A low cost, leadless 3x3 mm QFN surface mount package (LP3) houses the linear amplifier. The LP3 provides an exposed base for excellent RF and thermal performance.

Electrical Specifications, $T_A = +25^\circ C$, $V_s = +5V$

Parameter	Min.	Typ.	Max.	Min.	Typ.	Max.	Min.	Typ.	Max.	Units
Frequency Range	1.7 - 1.9			1.9 - 2.2			2.2 - 2.5			GHz
Gain	11.5	13.5		10.5	13		9	11.5		dB
Gain Variation Over Temperature		0.012	0.02		0.012	0.02		0.012	0.02	dB / °C
Input Return Loss		13			15			10		dB
Output Return Loss		10			18			15		dB
Output Power for 1dB Compression (P1dB)	24	27		24.5	27.5		23	26		dBm
Saturated Output Power (Psat)		28.5			28			27		dBm
Output Third Order Intercept (IP3)	37	40		39	42		37	40		dBm
Noise Figure		7			6			6		dB
Supply Current (Icq)		150			150			150		mA

Information furnished by Analog Devices is believed to be accurate and reliable. However, no responsibility is assumed by Analog Devices for its use, nor for any infringements of patents or other rights of third parties that may result from its use. Specifications subject to change without notice. No license is granted by implication or otherwise under any patent or patent rights of Analog Devices. Trademarks and registered trademarks are the property of their respective owners.

For price, delivery, and to place orders: Analog Devices, Inc., One Technology Way, P.O. Box 9106, Norwood, MA 02062-9106
Phone: 781-329-4700 • Order online at www.analog.com
Application Support: Phone: 1-800-ANALOG-D



Broadband Gain & Return Loss

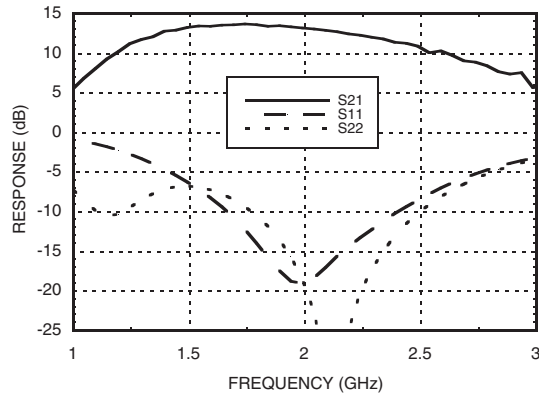

Gain vs. Temperature

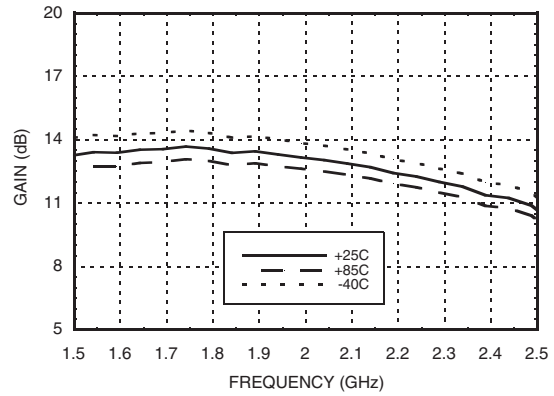

Input Return Loss vs. Temperature

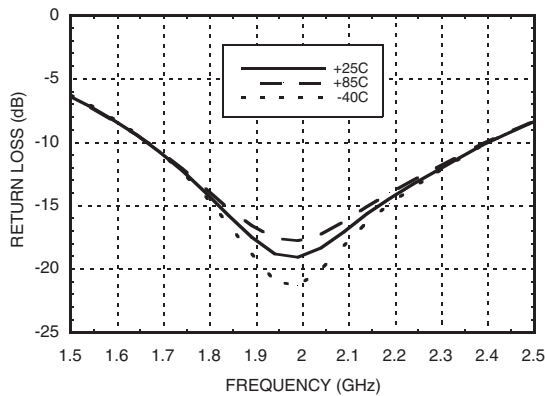

Output Return Loss vs. Temperature

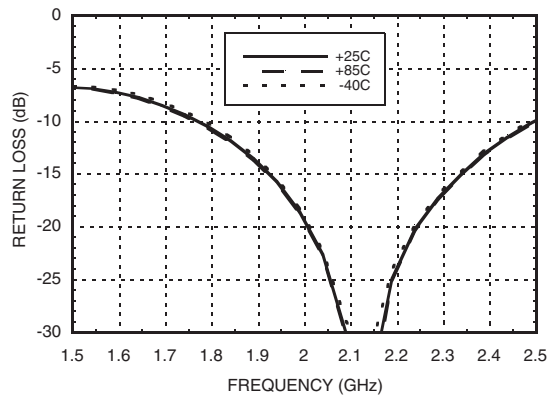

P1dB vs. Temperature

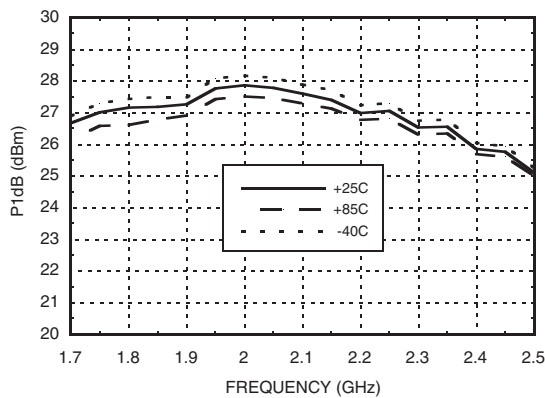

Psat vs. Temperature

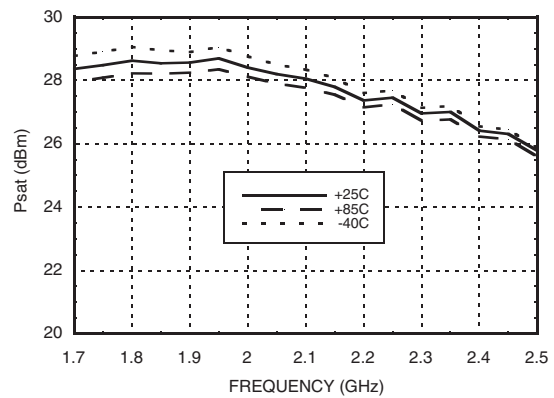

Data shown is tuned for 1.85 - 2.2 GHz, contact HMC
Applications for recommended 1.7 - 1.85 GHz & 2.2 - 2.5 GHz tuning circuits.

Information furnished by Analog Devices is believed to be accurate and reliable. However, no responsibility is assumed by Analog Devices for its use, nor for any infringements of patents or other rights of third parties that may result from its use. Specifications subject to change without notice. No license is granted by implication or otherwise under any patent or patent rights of Analog Devices. Trademarks and registered trademarks are the property of their respective owners.

For price, delivery, and to place orders: Analog Devices, Inc., One Technology Way, P.O. Box 9106, Norwood, MA 02062-9106 Phone: 781-329-4700 • Order online at www.analog.com Application Support: Phone: 1-800-ANALOG-D



Output IP3 vs. Temperature

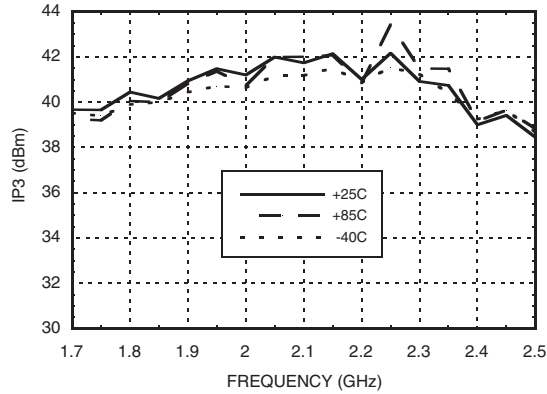

Noise Figure vs. Temperature

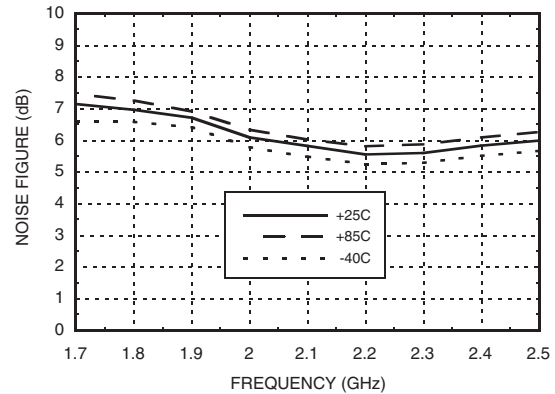

Power Compression @ 1.95 GHz

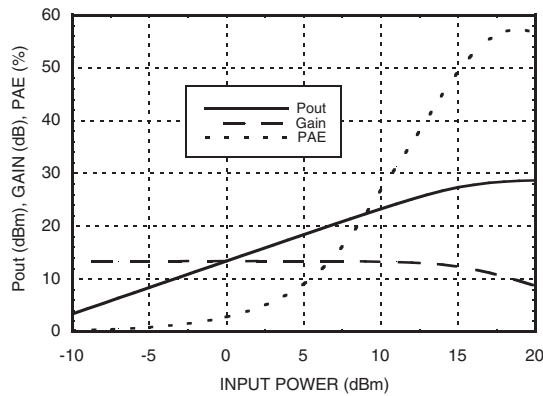

Power Compression @ 2.15 GHz

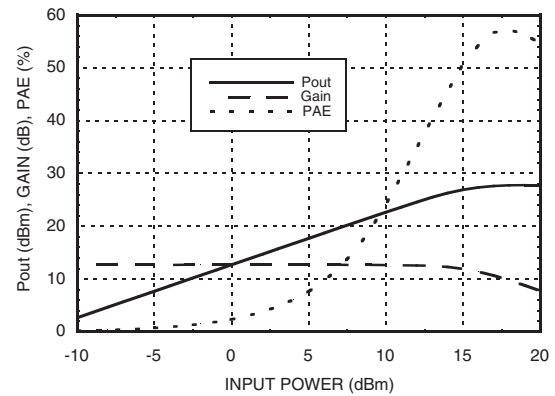

Reverse Isolation vs. Temperature

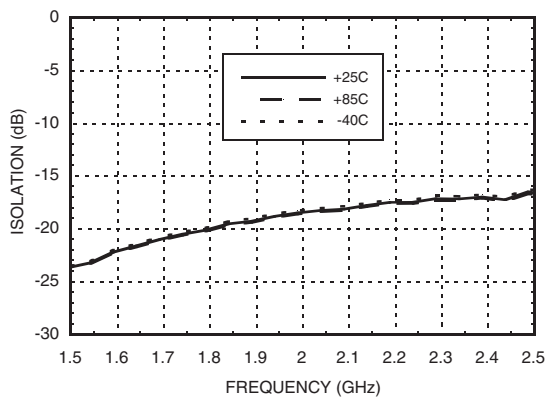

Gain, Power & IP3 vs. Supply Voltage @ 1.95 GHz

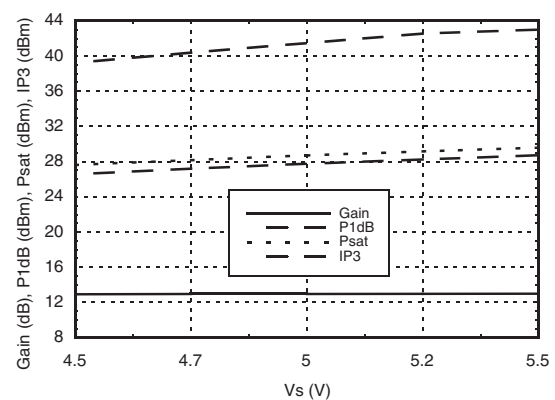

Data shown is tuned for 1.85 - 2.2 GHz, contact HMC
Applications for recommended 1.7 - 1.85 GHz & 2.2 - 2.5 GHz tuning circuits.

Information furnished by Analog Devices is believed to be accurate and reliable. However, no responsibility is assumed by Analog Devices for its use, nor for any infringements of patents or other rights of third parties that may result from its use. Specifications subject to change without notice. No license is granted by implication or otherwise under any patent or patent rights of Analog Devices. Trademarks and registered trademarks are the property of their respective owners.

For price, delivery, and to place orders: Analog Devices, Inc., One Technology Way, P.O. Box 9106, Norwood, MA 02062-9106 Phone: 781-329-4700 • Order online at www.analog.com Application Support: Phone: 1-800-ANALOG-D

InGaP HBT 1/2 Watt High IP3 AMPLIFIER, 1.7 - 2.5 GHz



**ACPR vs. Supply Voltage @ 1.96 GHz
CDMA 2000, 9 Channels Forward**

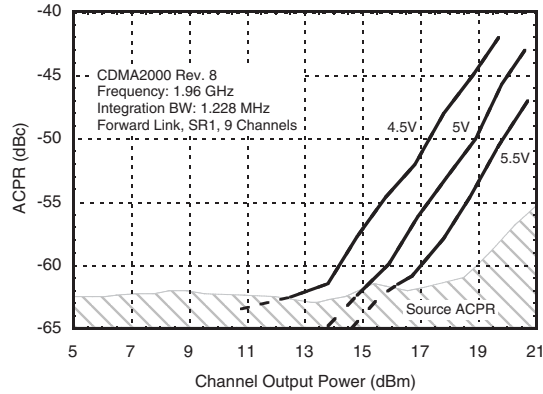

**ACPR vs. Supply Voltage @ 2.14 GHz
W-CDMA, 64 DPCH**

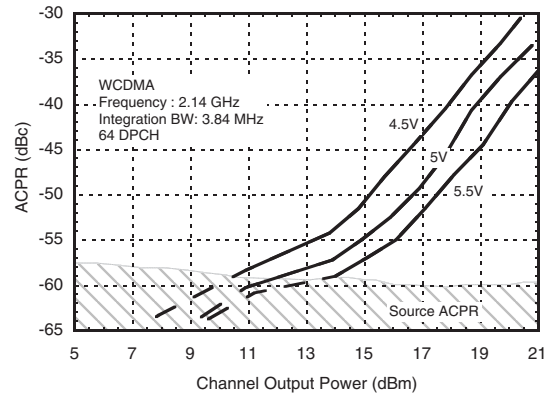

Absolute Maximum Ratings

Collector Bias Voltage (Vcc)	+6.0 Vdc
RF Input Power (RFIN)(Vs = +5Vdc)	+25 dBm
Junction Temperature	150 °C
Continuous P _{diss} (T = 85 °C) (derate 16 mW/°C above 85 °C)	1.04 W
Thermal Resistance (junction to ground paddle)	63 °C/W
Storage Temperature	-65 to +150 °C
Operating Temperature	-40 to +85 °C



**ELECTROSTATIC SENSITIVE DEVICE
OBSERVE HANDLING PRECAUTIONS**

Application Circuit

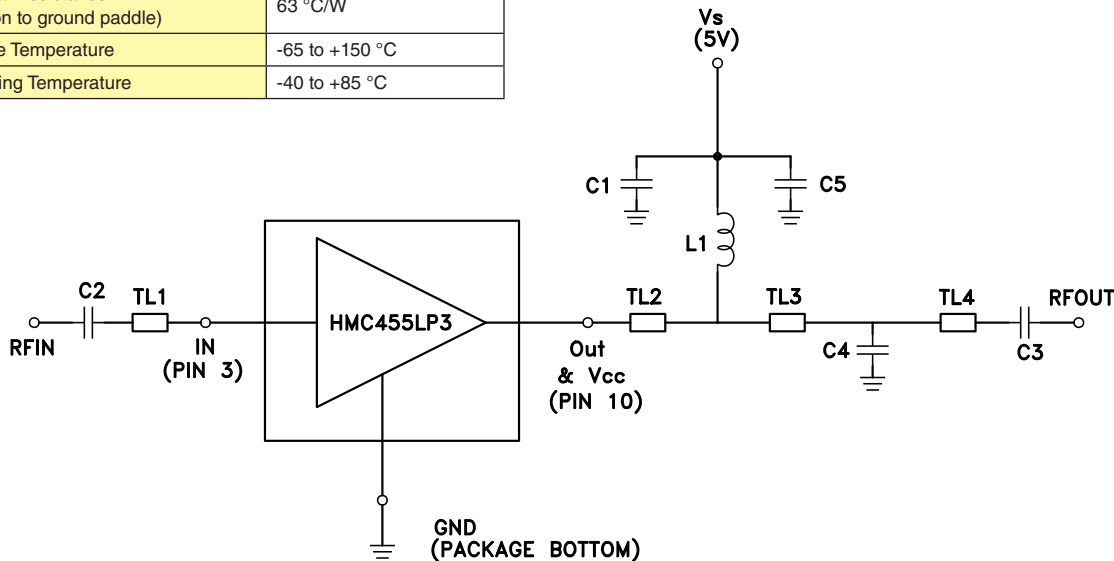

	TL1	TL2	TL3	TL4
Impedance	50 Ohm	50 Ohm	50 Ohm	50 Ohm
Physical Length	0.33"	0.18"	0.13"	0.04"
Electrical Length	34°	19°	13.5°	4°
PCB Material: 10 mil Rogers 4350, Er = 3.48				

Recommended Component Values	
L1	8.2 nH
C1	2.2 μF
C2, C3	3.0 pF
C4	0.9 pF
C5	100 pF

Data shown is tuned for 1.85 - 2.2 GHz, contact HMC
Applications for recommended 1.7 - 1.85 GHz & 2.2 - 2.5 GHz tuning circuits.

Information furnished by Analog Devices is believed to be accurate and reliable. However, no responsibility is assumed by Analog Devices for its use, nor for any infringements of patents or other rights of third parties that may result from its use. Specifications subject to change without notice. No license is granted by implication or otherwise under any patent or patent rights of Analog Devices. Trademarks and registered trademarks are the property of their respective owners.

For price, delivery, and to place orders: Analog Devices, Inc., One Technology Way, P.O. Box 9106, Norwood, MA 02062-9106
Phone: 781-329-4700 • Order online at www.analog.com
Application Support: Phone: 1-800-ANALOG-D



Outline Drawing

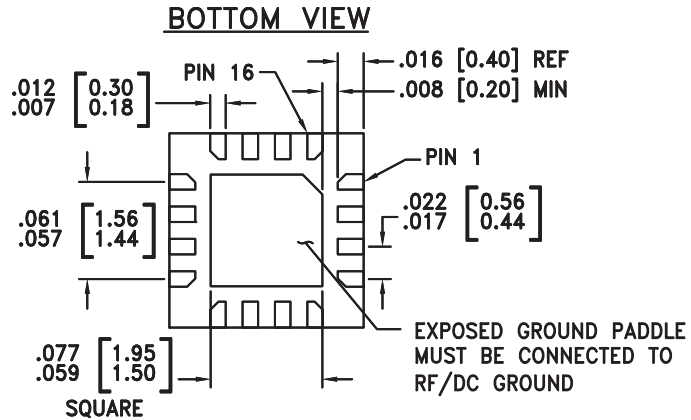
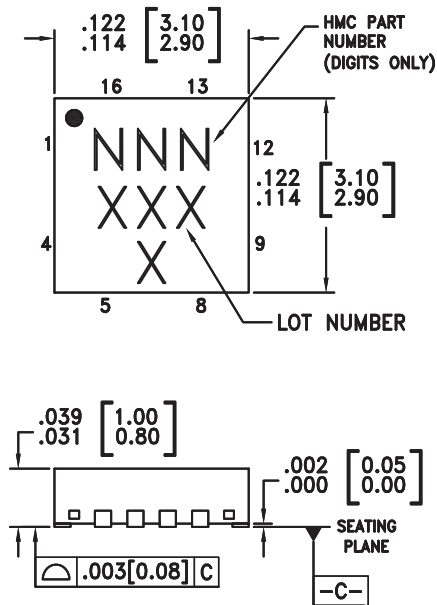

NOTES:

1. LEADFRAME MATERIAL: COPPER ALLOY
2. DIMENSIONS ARE IN INCHES [MILLIMETERS]
3. LEAD SPACING TOLERANCE IS NON-CUMULATIVE
4. PAD BURR LENGTH SHALL BE 0.15mm MAXIMUM.
PAD BURR HEIGHT SHALL BE 0.05mm MAXIMUM.
5. PACKAGE WARP SHALL NOT EXCEED 0.05mm.
6. ALL GROUND LEADS AND GROUND PADDLE MUST BE SOLDERED TO PCB RF GROUND.
7. REFER TO HITTITE APPLICATION NOTE FOR SUGGESTED LAND PATTERN.

Package Information

Part Number	Package Body Material	Lead Finish	MSL Rating	Package Marking ^[3]
HMC455LP3	Low Stress Injection Molded Plastic	Sn/Pb Solder	MSL1 ^[1]	455 XXXX
HMC455LP3E	RoHS-compliant Low Stress Injection Molded Plastic	100% matte Sn	MSL1 ^[2]	455 XXXX

[1] Max peak reflow temperature of 235 °C
 [2] Max peak reflow temperature of 260 °C
 [3] 4-Digit lot number XXXX

Pin Descriptions

Pin Number	Function	Description	Interface Schematic
1, 2, 4 - 9, 11 - 16	N/C	This pin may be connected to RF ground.	
3	RFIN	This pin is AC coupled. An off chip series matching capacitor is required.	
10	RFOUT	RF output and DC Bias for the output stage.	
	GND	Package bottom must be connected to RF/DC ground.	

Information furnished by Analog Devices is believed to be accurate and reliable. However, no responsibility is assumed by Analog Devices for its use, nor for any infringements of patents or other rights of third parties that may result from its use. Specifications subject to change without notice. No license is granted by implication or otherwise under any patent or patent rights of Analog Devices. Trademarks and registered trademarks are the property of their respective owners.

For price, delivery, and to place orders: Analog Devices, Inc., One Technology Way, P.O. Box 9106, Norwood, MA 02062-9106
 Phone: 781-329-4700 • Order online at www.analog.com
 Application Support: Phone: 1-800-ANALOG-D



Evaluation PCB

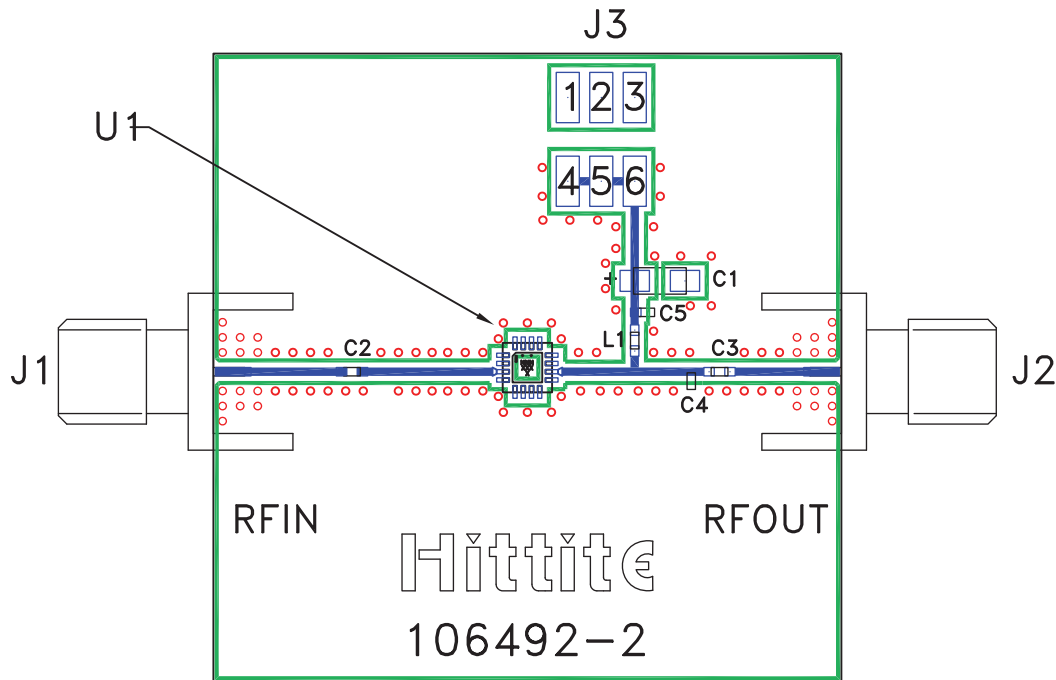

J3

Pin Number	Description
1, 2, 3	GND
4, 5, 6	Vs

List of Materials for Evaluation PCB 106058 [1]

Item	Description
J1 - J2	PCB Mount SMA Connector
J3	2 mm DC Header
C1	2.2 μ F Capacitor, Tantalum
C2, C3	3.0 pF Capacitor, 0402 Pkg.
C4	0.9 pF Capacitor, 0402 Pkg.
C5	100 pF Capacitor, 0402 Pkg.
L1	8.2 nH Inductor, 0402 Pkg.
U1	HMC455LP3 / HMC455LP3E Power Amplifier
PCB [2]	106492 Evaluation PCB, 10 mils

[1] Reference this number when ordering complete evaluation PCB

[2] Circuit Board Material: Rogers 4350, Er = 3.48

The circuit board used in the final application should use RF circuit design techniques. Signal lines should have 50 ohm impedance while the package ground leads and exposed paddle should be connected directly to the ground plane similar to that shown. A sufficient number of VIA holes should be used to connect the top and bottom ground planes. The evaluation board should be mounted to an appropriate heat sink. The evaluation circuit board shown is available from Hittite upon request.

Data shown is tuned for 1.85 - 2.2 GHz, contact HMC

Applications for recommended 1.7 - 1.85 GHz & 2.2 - 2.5 GHz tuning circuits.

Mouser Electronics

Authorized Distributor

Click to View Pricing, Inventory, Delivery & Lifecycle Information:

[Analog Devices Inc.:](#)

[HMC455LP3E](#) [HMC455LP3](#) [HMC455LP3ETR](#) [HMC455LP3TR](#) [106058-HMC455LP3](#)