

FEATURES

Enhanced product features

- Supports defense and aerospace applications (AQEC)
- Military temperature range (–55°C to +125°C)
- Controlled manufacturing baseline
- One assembly/test site
- One fabrication site
- Enhanced product change notification
- Qualification data available on request

Low power, quad 16-bit DAC

14-lead TSSOP

- On-chip 1.25 V/2.5 V, 5 ppm/°C reference
- Power down to 400 nA at 5 V, 200 nA at 3 V
- 2.7 V to 5.5 V power supply
- Guaranteed monotonic by design
- Power-on reset to zero scale or midscale
- 3 power-down functions
- Hardware LDAC with LDAC override function
- CLR function to programmable code
- SDO daisy-chaining option
- Rail-to-rail operation

APPLICATIONS

- Process control
- Data acquisition systems
- Portable battery-powered instruments
- Digital gain and offset adjustment
- Programmable voltage and current sources
- Programmable attenuators

GENERAL DESCRIPTION

The AD5666-EP is a low power, quad 16-bit, buffered voltage-output DAC. The part operates from a single 2.7 V to 5.5 V supply and is guaranteed monotonic by design.

The AD5666-EP has an on-chip reference with an internal gain of 2. The AD5666-EP-2 has a 2.5 V, 5 ppm/°C reference, giving a full-scale output of 5 V. The on-board reference is off at power-up, allowing the use of an external reference. The internal reference is turned on by writing to the DAC.

The part incorporates a power-on reset circuit that ensures that the DAC output powers up to 0 V (POR pin low) or to midscale (POR pin high) and remains powered up at this level until a valid write takes place. The part contains a power-down feature that reduces the current consumption of the device to 400 nA at 5 V and provides software-selectable output loads while in power-down mode for any or all DAC channels.

The outputs of all DACs can be updated simultaneously using the LDAC function, with the added functionality of user-selectable DAC channels to simultaneously update. There is also an asynchronous CLR that clears all DACs to a software-selectable code—0 V, midscale, or full scale.

The AD5666-EP uses a versatile 3-wire serial interface that operates at clock rates of up to 50 MHz and is compatible with standard SPI, QSPI, MICROWIRE, and DSP interface standards. The on-chip precision output amplifier enables rail-to-rail output swing.

Additional application and technical information can be found in the [AD5666](#) data sheet.

PRODUCT HIGHLIGHTS

1. Quad, 16-bit DAC.
2. On-chip 2.5 V, 5 ppm/°C reference.
3. Available in 14-lead TSSOP.
4. Selectable power-on reset to 0 V or midscale.
5. Power-down capability. When powered down, the DAC typically consumes 200 nA at 3 V and 400 nA at 5 V.

FUNCTIONAL BLOCK DIAGRAM

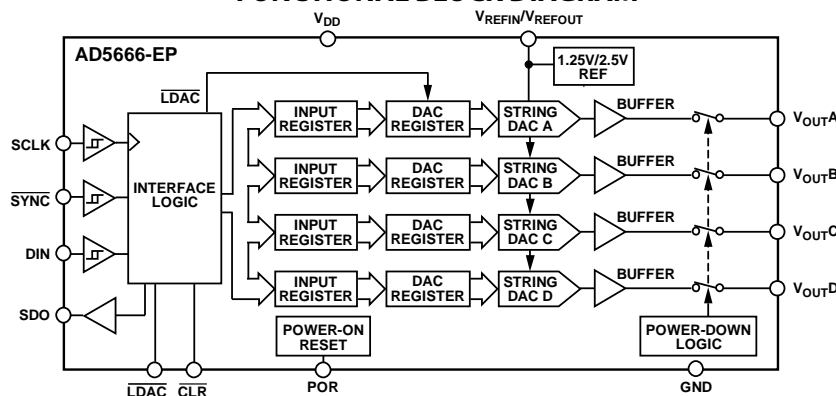

Figure 1.

Rev. 0

Information furnished by Analog Devices is believed to be accurate and reliable. However, no responsibility is assumed by Analog Devices for its use, nor for any infringements of patents or other rights of third parties that may result from its use. Specifications subject to change without notice. No license is granted by implication or otherwise under any patent or patent rights of Analog Devices. Trademarks and registered trademarks are the property of their respective owners.

TABLE OF CONTENTS

Features	1	Timing Characteristics	6
Applications.....	1	Absolute Maximum Ratings	8
General Description	1	ESD Caution.....	8
Product Highlights	1	Pin Configuration and Function Descriptions.....	9
Functional Block Diagram	1	Typical Performance Characteristics	10
Revision History	2	Outline Dimensions	16
Specifications.....	3	Ordering Guide	16
AC Characteristics.....	5		

REVISION HISTORY

11/10—Revision 0: Initial Version

SPECIFICATIONS

$V_{DD} = 4.5\text{ V to }5.5\text{ V}$, $R_L = 2\text{ k}\Omega$ to GND, $C_L = 200\text{ pF}$ to GND, $V_{REFIN} = V_{DD}$. All specifications T_{MIN} to T_{MAX} , unless otherwise noted.

Table 1.

Parameter	B Grade ¹			Unit	Test Conditions/Comments
	Min	Typ	Max		
STATIC PERFORMANCE²					
Resolution	16			Bits	
Relative Accuracy			± 21	LSB	See Figure 6
Differential Nonlinearity			± 1	LSB	Guaranteed monotonic by design (see Figure 7)
Zero-Code Error		1	14	mV	All 0s loaded to DAC register (see Figure 13)
Zero-Code Error Drift		± 2		$\mu\text{V}/^\circ\text{C}$	
Full-Scale Error		-0.2	-1	% FSR	All 1s loaded to DAC register (see Figure 12)
Gain Error			± 1	% FSR	
Gain Temperature Coefficient		± 2.5		ppm	Of FSR/ $^\circ\text{C}$
Offset Error		± 1	± 14	mV	
DC Power Supply Rejection Ratio		-80		dB	$V_{DD} \pm 10\%$
DC Crosstalk (External Reference)		10		μV	Due to full-scale output change, $R_L = 2\text{ k}\Omega$ to GND or V_{DD}
		5		$\mu\text{V}/\text{mA}$	Due to load current change
		10		μV	Due to powering down (per channel)
DC Crosstalk (Internal Reference)		25		μV	Due to full-scale output change, $R_L = 2\text{ k}\Omega$ to GND or V_{DD}
		10		$\mu\text{V}/\text{mA}$	Due to load current change
OUTPUT CHARACTERISTICS³					
Output Voltage Range	0		V_{DD}	V	
Capacitive Load Stability		2		nF	$R_L = \infty$
		10		nF	$R_L = 2\text{ k}\Omega$
DC Output Impedance		0.5		Ω	
Short-Circuit Current		30		mA	$V_{DD} = 5\text{ V}$
Power-Up Time		4		μs	Coming out of power-down mode $V_{DD} = 5\text{ V}$
REFERENCE INPUTS					
Reference Input Voltage		V_{DD}		V	
Reference Current		20	55	μA	$V_{REF} = V_{DD} = 5.5\text{ V}$
Reference Input Range	0		V_{DD}	V	
Reference Input Impedance		14.6		k Ω	Per DAC channel
REFERENCE OUTPUT					
Output Voltage	2.495		2.505	V	At ambient
Reference Temperature Coefficient ³		± 5		ppm/ $^\circ\text{C}$	
Reference Output Impedance		7.5		k Ω	
LOGIC INPUTS³					
Input Current			± 3	μA	All digital inputs
Input Low Voltage, V_{INL}			0.8	V	$V_{DD} = 5\text{ V}$
Input High Voltage, V_{INH}	2			V	$V_{DD} = 5\text{ V}$
Pin Capacitance		3		pF	
LOGIC OUTPUTS (SDO)³					
Output Low Voltage, V_{OL}			0.4	V	$I_{SINK} = 2\text{ mA}$
Output High Voltage, V_{OH}	$V_{DD} - 1$			V	$I_{SOURCE} = 2\text{ mA}$
High Impedance Leakage Current			± 0.25	μA	
High Impedance Output Capacitance		2		pF	

AD5666-EP

Parameter	B Grade ¹			Unit	Test Conditions/Comments
	Min	Typ	Max		
POWER REQUIREMENTS					
V _{DD}	4.5		5.5	V	All digital inputs at 0 or V _{DD} , DAC active, excludes load current
I _{DD} (Normal Mode) ⁴					V _{IH} = V _{DD} and V _{IL} = GND
V _{DD} = 4.5 V to 5.5 V		0.7	0.9	mA	Internal reference off
V _{DD} = 4.5 V to 5.5 V		1.3	1.6	mA	Internal reference on
I _{DD} (All Power-Down Modes) ⁵					
V _{DD} = 4.5 V to 5.5 V		0.4	1	μA	V _{IH} = V _{DD} and V _{IL} = GND

¹ Temperature range is -40°C to +105°C, typical at 25°C.

² Temperature range is -55°C to +125°C, typical at 25°C. Linearity calculated using a reduced code range of 512 to 65,024. Output unloaded.

³ Guaranteed by design and characterization; not production tested.

⁴ Interface inactive. All DACs active. DAC outputs unloaded.

⁵ All four DACs powered down.

AC CHARACTERISTICS

$V_{DD} = 2.7\text{ V to } 5.5\text{ V}$, $R_L = 2\text{ k}\Omega$ to GND, $C_L = 200\text{ pF}$ to GND, $V_{REFIN} = V_{DD}$. All specifications T_{MIN} to T_{MAX} , unless otherwise noted.

Table 2.

Parameter ¹	Min	Typ	Max	Unit	Test Conditions/Comments ²
Output Voltage Settling Time		6	10	μs	$\frac{1}{4}$ to $\frac{3}{4}$ scale settling to ± 2 LSB
Slew Rate		1.5		$\text{V}/\mu\text{s}$	
Digital-to-Analog Glitch Impulse		4		$\text{nV}\cdot\text{sec}$	1 LSB change around major carry (see Figure 29)
Reference Feedthrough		-90		dB	$V_{REF} = 2\text{ V} \pm 0.1\text{ V p-p}$, frequency = 10 Hz to 20 MHz
SDO Feedthrough		3		$\text{nV}\cdot\text{sec}$	Daisy-chain mode; SDO load is 10 pF
Digital Feedthrough		0.1		$\text{nV}\cdot\text{sec}$	
Digital Crosstalk		0.5		$\text{nV}\cdot\text{sec}$	
Analog Crosstalk		2.5		$\text{nV}\cdot\text{sec}$	
DAC-to-DAC Crosstalk		3		$\text{nV}\cdot\text{sec}$	
Multiplying Bandwidth		340		kHz	$V_{REF} = 2\text{ V} \pm 0.2\text{ V p-p}$
Total Harmonic Distortion		-80		dB	$V_{REF} = 2\text{ V} \pm 0.1\text{ V p-p}$, frequency = 10 kHz
Output Noise Spectral Density		120		$\text{nV}/\sqrt{\text{Hz}}$	DAC code = 0x8400, 1 kHz
		100		$\text{nV}/\sqrt{\text{Hz}}$	DAC code = 0x8400, 10 kHz
Output Noise		15		$\mu\text{V p-p}$	0.1 Hz to 10 Hz

¹ Guaranteed by design and characterization; not production tested.

² Temperature range is -55°C to $+125^\circ\text{C}$, typical at 25°C .

AD5666-EP

TIMING CHARACTERISTICS

All input signals are specified with $t_r = t_f = 1 \text{ ns/V}$ (10% to 90% of V_{DD}) and timed from a voltage level of $(V_{IL} + V_{IH})/2$. See Figure 3 and Figure 4. $V_{DD} = 2.7 \text{ V}$ to 5.5 V . All specifications T_{MIN} to T_{MAX} , unless otherwise noted.

Table 3.

Parameter	Limit at T_{MIN} , T_{MAX} $V_{DD} = 2.7 \text{ V}$ to 5.5 V	Unit	Test Conditions/Comments
t_1^1	20	ns min	SCLK cycle time
t_2	8	ns min	SCLK high time
t_3	8	ns min	SCLK low time
t_4	13	ns min	$\overline{\text{SYNC}}$ -to-SCLK falling edge setup time
t_5	4	ns min	Data setup time
t_6	4	ns min	Data hold time
t_7	0	ns min	SCLK falling edge to $\overline{\text{SYNC}}$ rising edge
t_8	15	ns min	Minimum $\overline{\text{SYNC}}$ high time
t_9	13	ns min	$\overline{\text{SYNC}}$ rising edge to SCLK fall ignore
t_{10}	0	ns min	SCLK falling edge to $\overline{\text{SYNC}}$ fall ignore
t_{11}	10	ns min	$\overline{\text{LDAC}}$ pulse width low
t_{12}	15	ns min	SCLK falling edge to $\overline{\text{LDAC}}$ rising edge
t_{13}	5	ns min	$\overline{\text{CLR}}$ pulse width low
t_{14}	0	ns min	SCLK falling edge to $\overline{\text{LDAC}}$ falling edge
t_{15}	300	ns typ	$\overline{\text{CLR}}$ pulse activation time
t_{16}^2	22	ns max	SCLK rising edge to SDO valid
t_{17}^2	5	ns min	SCLK falling edge to $\overline{\text{SYNC}}$ rising edge
t_{18}^2	8	ns min	$\overline{\text{SYNC}}$ rising edge to SCLK rising edge
t_{19}^2	0	ns min	$\overline{\text{SYNC}}$ rising edge to $\overline{\text{LDAC}}$ falling edge

¹ Maximum SCLK frequency is 50 MHz at $V_{DD} = 2.7 \text{ V}$ to 5.5 V . Guaranteed by design and characterization; not production tested.

² Daisy-chain mode only.

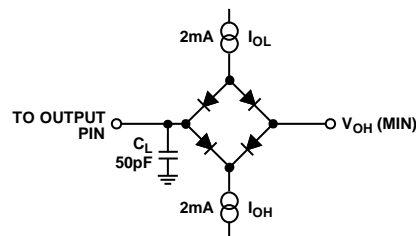
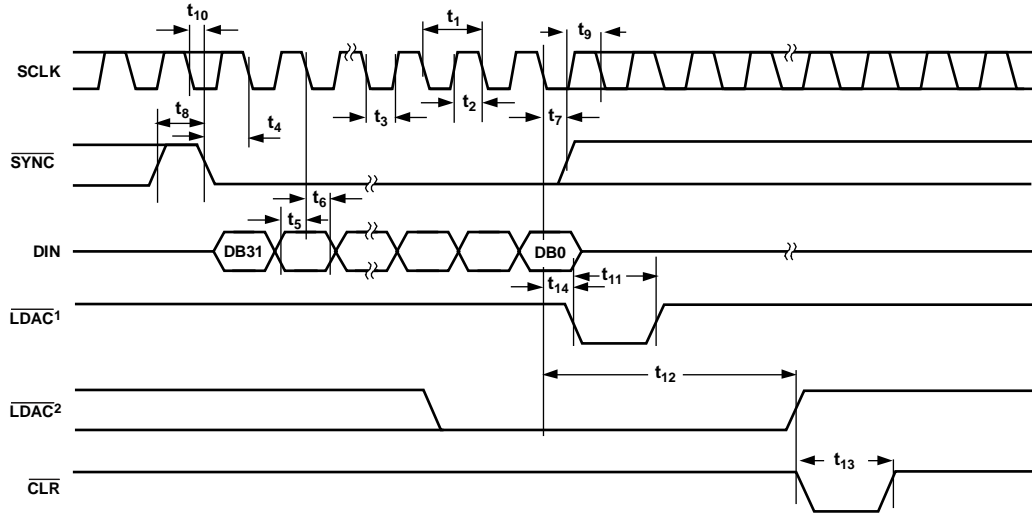

Figure 2. Load Circuit for Digital Output (SDO) Timing Specifications



¹ASYNCHRONOUS LDAC UPDATE MODE
²SYNCHRONOUS LDAC UPDATE MODE

09511-003

Figure 3. Serial Write Operation

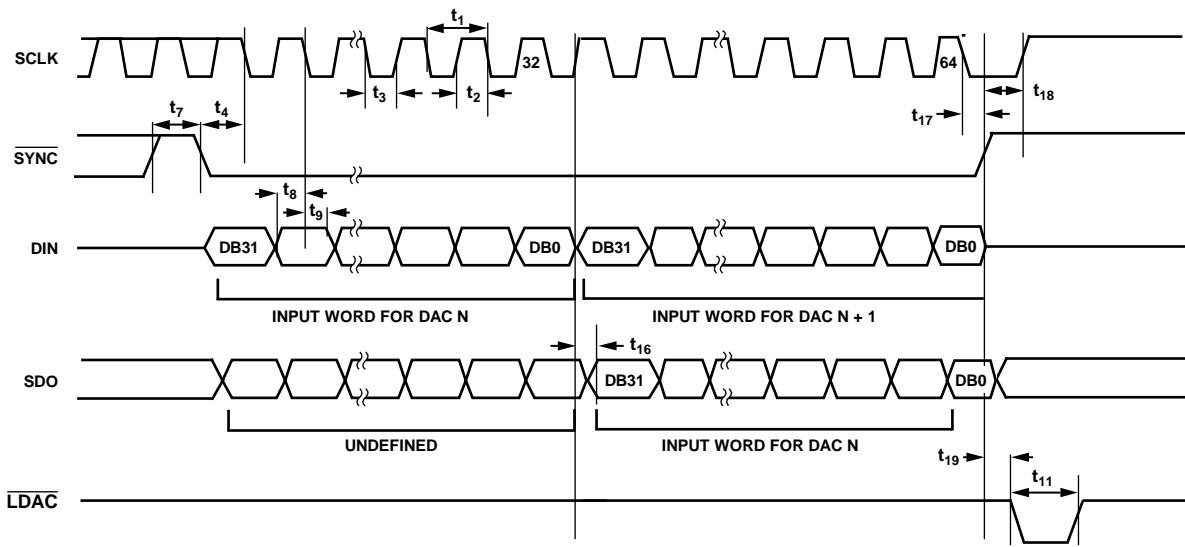

09511-004

Figure 4. Daisy-Chain Timing Diagram

ABSOLUTE MAXIMUM RATINGS

$T_A = 25^\circ\text{C}$, unless otherwise noted.

Table 4.

Parameter	Rating
V_{DD} to GND	-0.3 V to +7 V
Digital Input Voltage to GND	-0.3 V to $V_{DD} + 0.3$ V
V_{OUT} to GND	-0.3 V to $V_{DD} + 0.3$ V
V_{REFIN}/V_{REFOUT} to GND	-0.3 V to $V_{DD} + 0.3$ V
Operating Temperature Range Industrial	-55°C to $+125^\circ\text{C}$
Storage Temperature Range	-65°C to $+150^\circ\text{C}$
Junction Temperature ($T_{J\text{ MAX}}$)	150°C
TSSOP Package	
Power Dissipation	$(T_{J\text{ MAX}} - T_A)/\theta_{JA}$
θ_{JA} Thermal Impedance	150.4°C/W
Reflow Soldering Peak Temperature	
SnPb	240°C
Pb Free	260°C

Stresses above those listed under Absolute Maximum Ratings may cause permanent damage to the device. This is a stress rating only; functional operation of the device at these or any other conditions above those indicated in the operational section of this specification is not implied. Exposure to absolute maximum rating conditions for extended periods may affect device reliability.

ESD CAUTION



ESD (electrostatic discharge) sensitive device. Charged devices and circuit boards can discharge without detection. Although this product features patented or proprietary protection circuitry, damage may occur on devices subjected to high energy ESD. Therefore, proper ESD precautions should be taken to avoid performance degradation or loss of functionality.

PIN CONFIGURATION AND FUNCTION DESCRIPTIONS

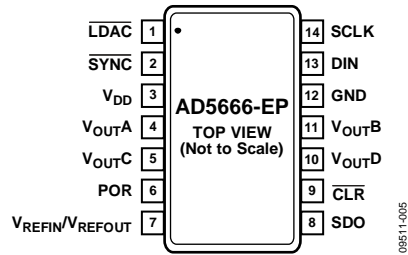

Figure 5. 14-Lead TSSOP (RU-14) Pin Configuration

Table 5. 14-Lead TSSOP (RU-14) Pin Function Descriptions

Pin No.	Mnemonic
1	LDAC
2	SYNC
3	V _{DD}
4	V _{OUTA}
5	V _{OUTC}
6	POR
7	V _{REFIN} /V _{REFOUT}
8	SDO
9	CLR
10	V _{OUTD}
11	V _{OUTB}
12	GND
13	DIN
14	SCLK

TYPICAL PERFORMANCE CHARACTERISTICS

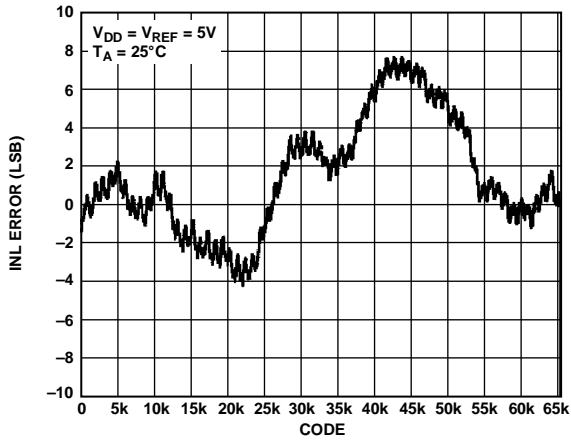

Figure 6. INL

09511-006

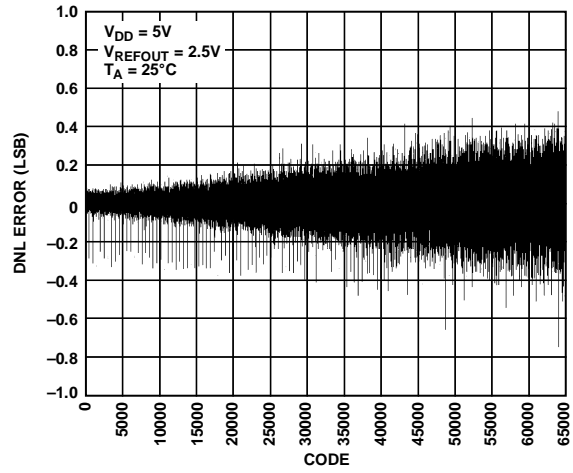

Figure 9. DNL—AD5666-EP-2

09511-009

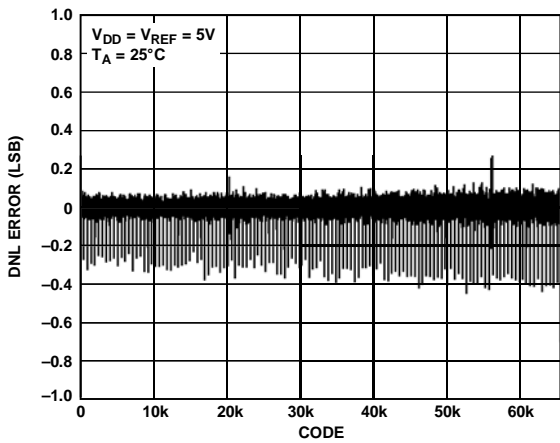

Figure 7. DNL

09511-007

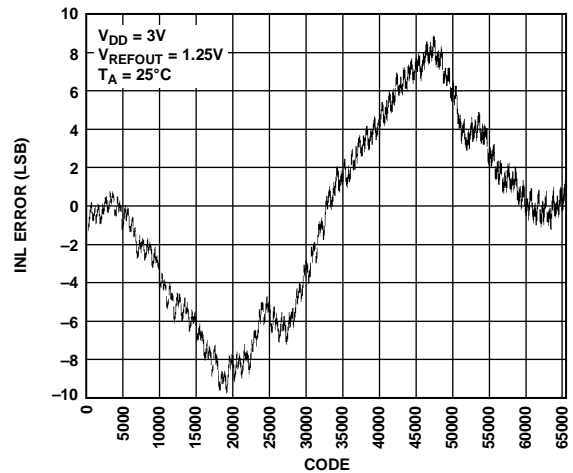

Figure 10. INL—AD5666-EP-1

09511-010

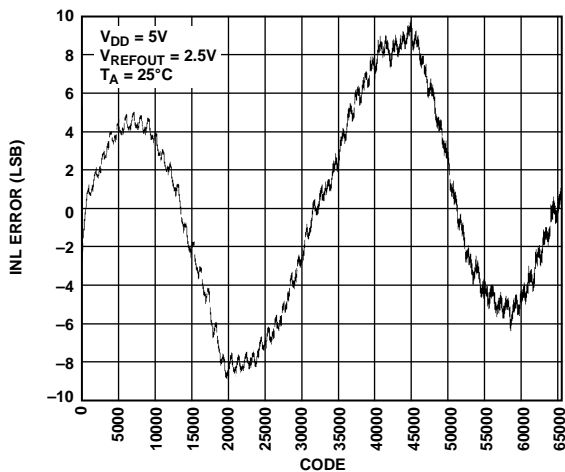

Figure 8. INL—AD5666-EP-2

09511-008

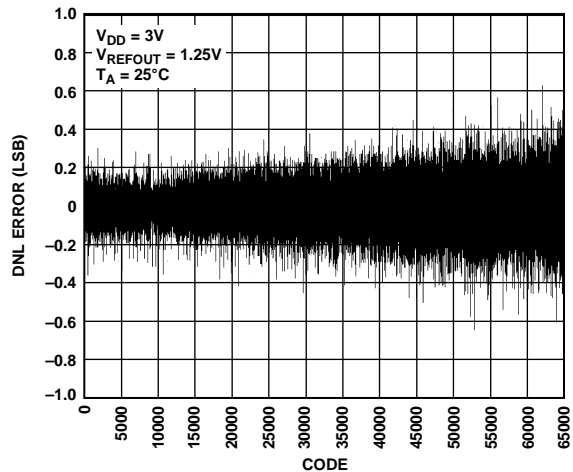

Figure 11. DNL—AD5666-EP-1

09511-011

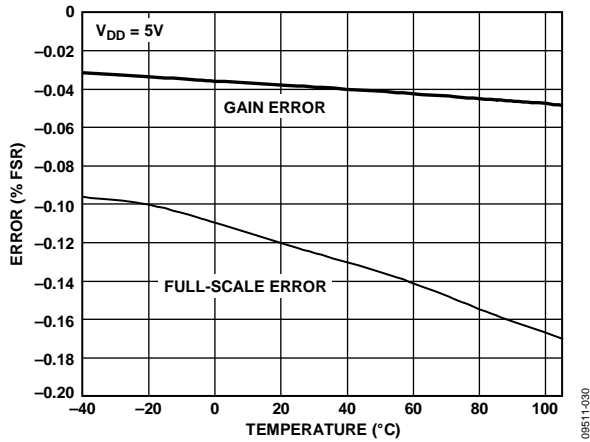

Figure 12. Gain Error and Full-Scale Error vs. Temperature

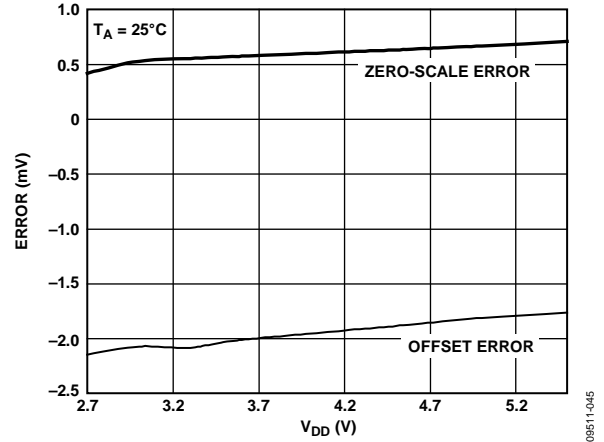

Figure 15. Zero-Scale Error and Offset Error vs. Supply Voltage

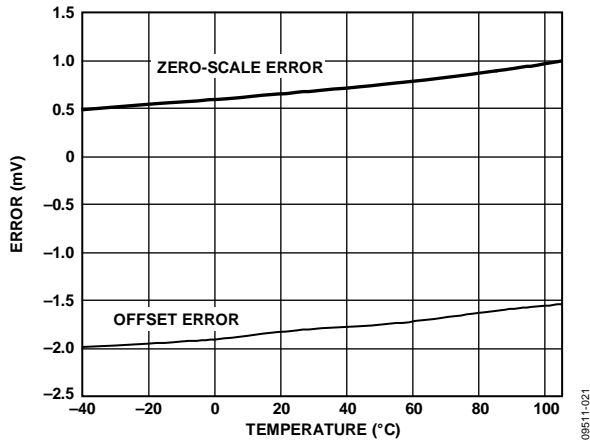

Figure 13. Zero-Scale Error and Offset Error vs. Temperature

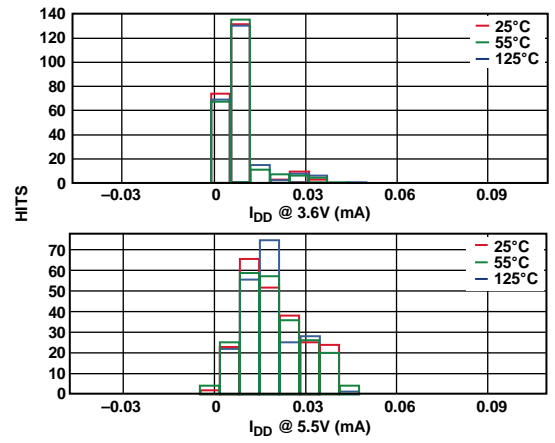

Figure 16. I_{DD} Histogram with External Reference

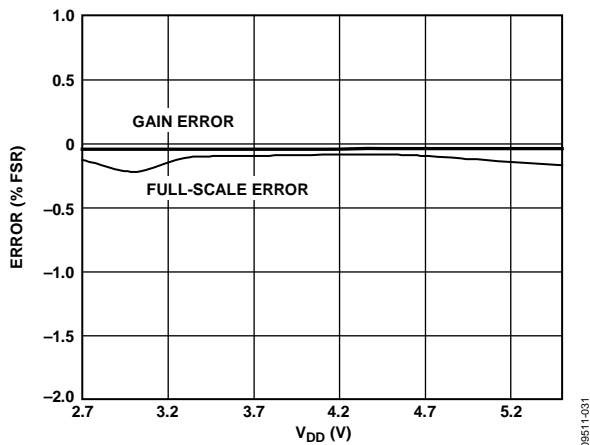

Figure 14. Gain Error and Full-Scale Error vs. Supply Voltage

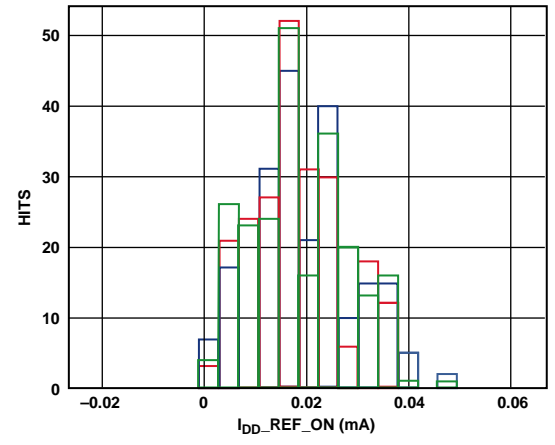

Figure 17. I_{DD} Histogram with Internal Reference

AD5666-EP

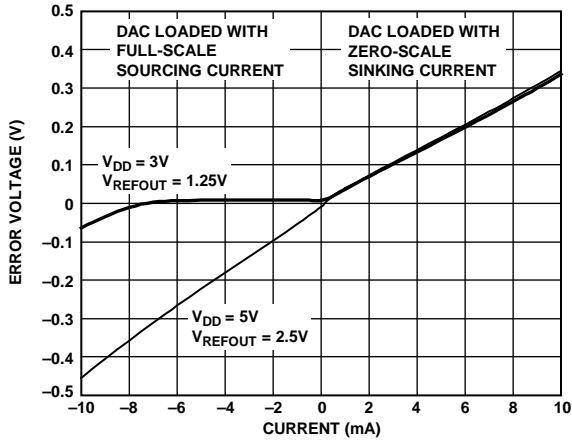

Figure 18. Headroom at Rails vs. Source and Sink

09511-019

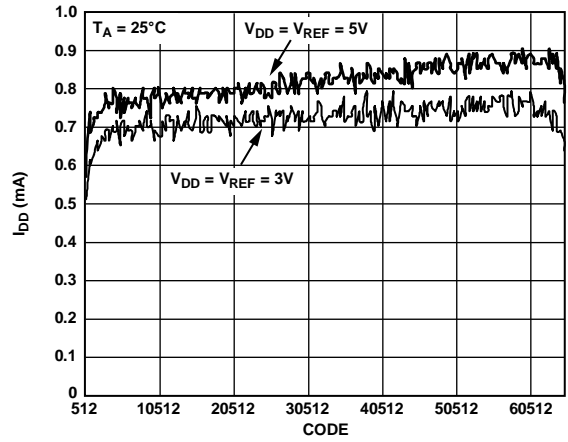

Figure 21. Supply Current vs. Code

09511-014

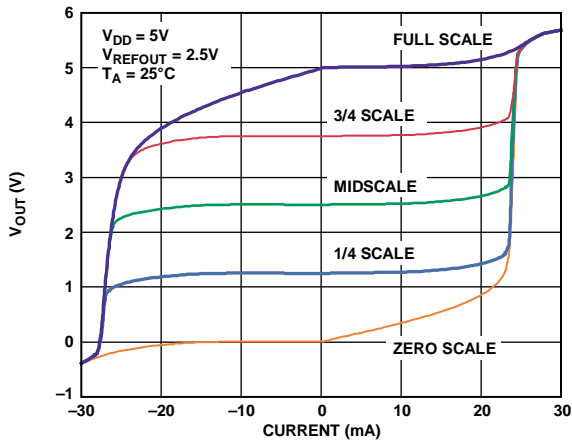

Figure 19. Source and Sink Current Capability with $V_{DD} = 5V$

09511-012

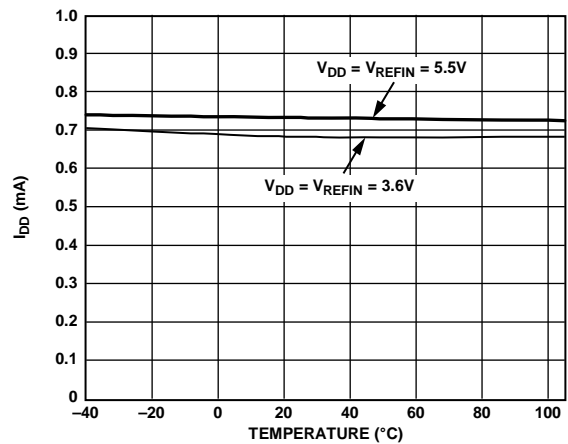

Figure 22. Supply Current vs. Temperature

09511-015

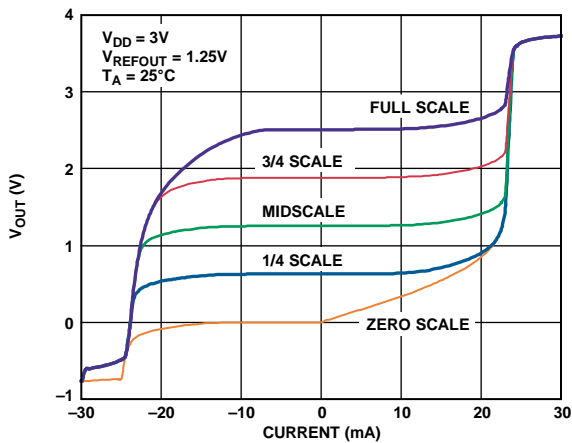

Figure 20. Source and Sink Current Capability with $V_{DD} = 3V$

09511-013

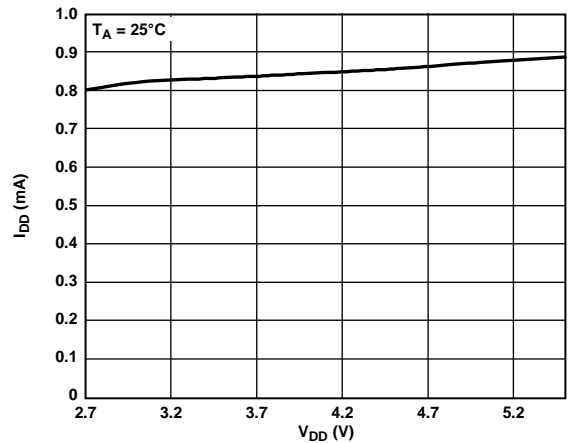

Figure 23. Supply Current vs. Supply Voltage

09511-016

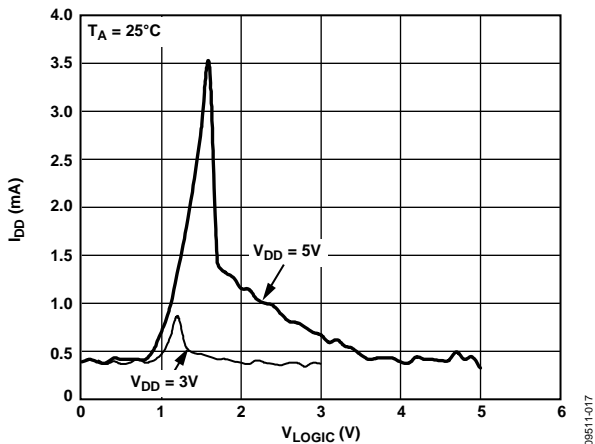

Figure 24. Supply Current vs. Logic Input Voltage

09511-017

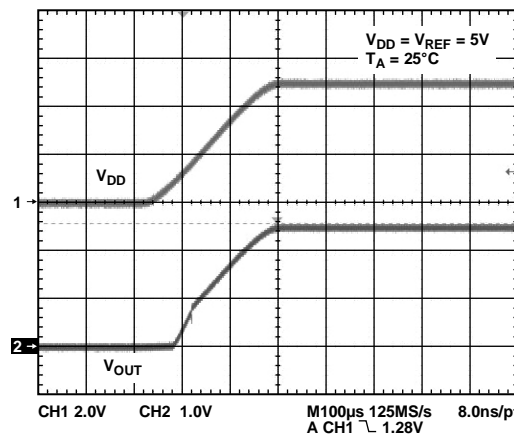

Figure 27. Power-On Reset to Midscale

09511-033

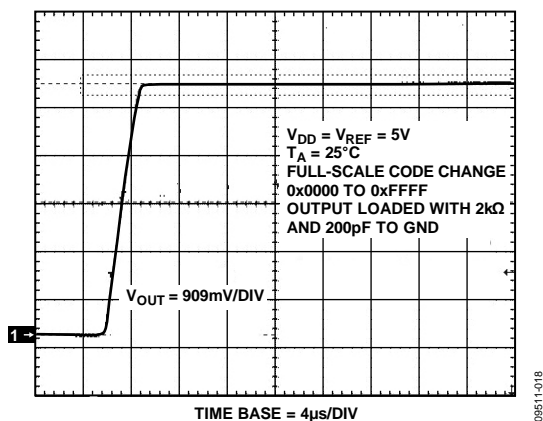

Figure 25. Full-Scale Settling Time

09511-018

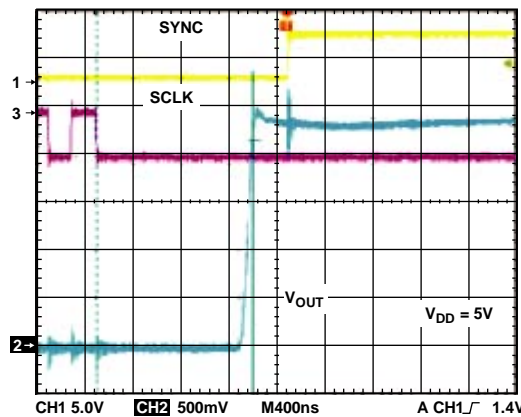

Figure 28. Exiting Power-Down to Midscale

09511-034

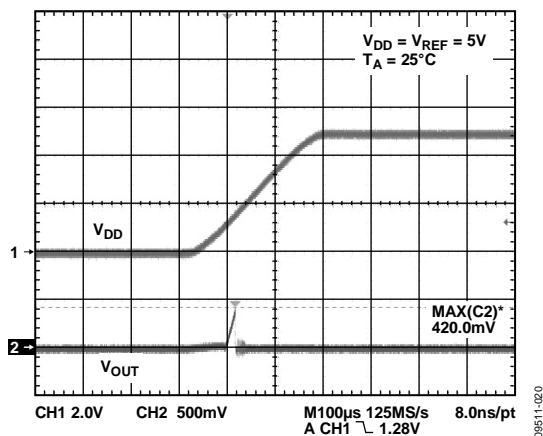

Figure 26. Power-On Reset to 0V

09511-020

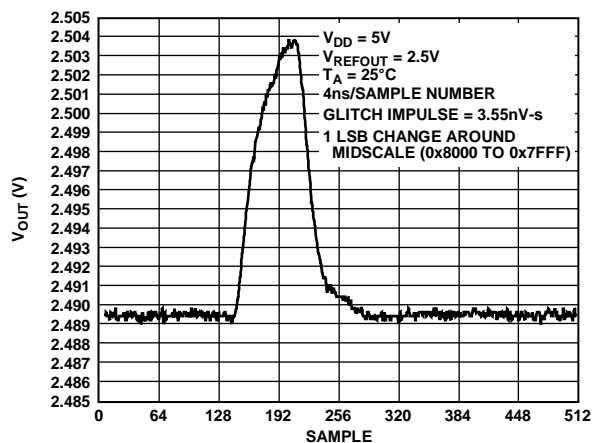

Figure 29. Digital-to-Analog Glitch Impulse

09511-022

AD5666-EP

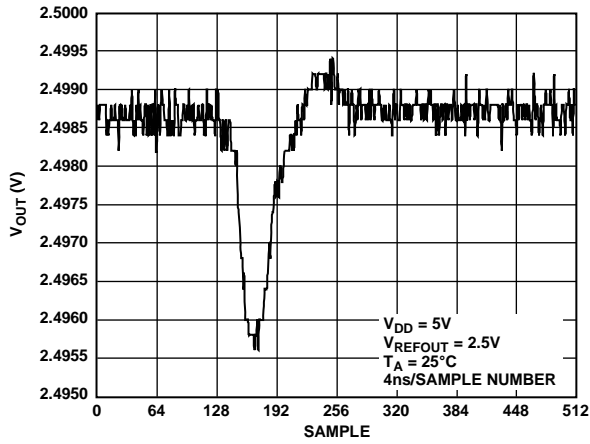

Figure 30. Analog Crosstalk

09511-035

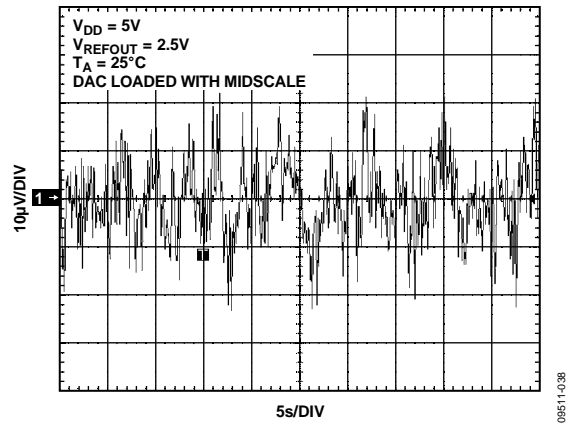

Figure 33. 0.1 Hz to 10 Hz Output Noise Plot, Internal Reference

09511-038

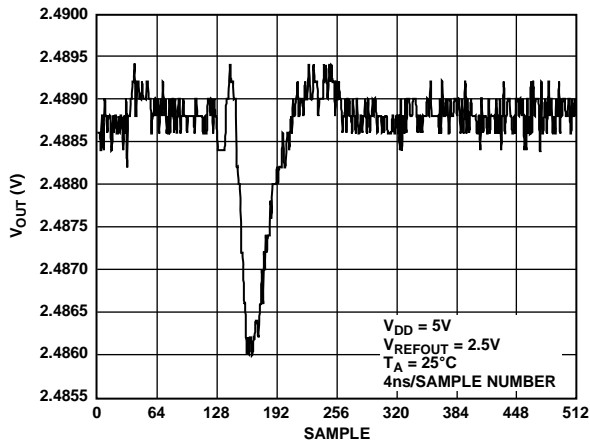

Figure 31. DAC-to-DAC Crosstalk

09511-036

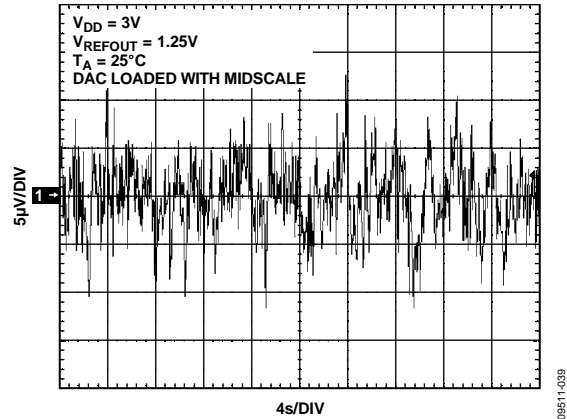

Figure 34. 0.1 Hz to 10 Hz Output Noise Plot, Internal Reference

09511-039

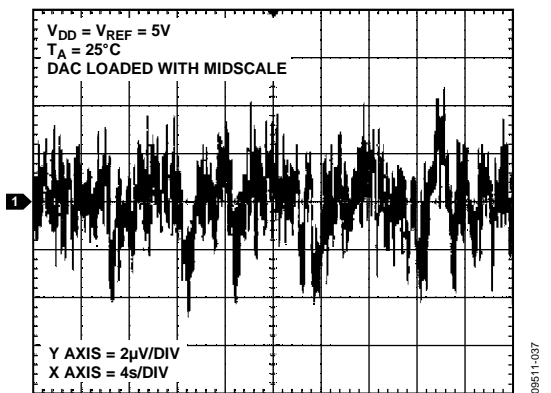

Figure 32. 0.1 Hz to 10 Hz Output Noise Plot, External Reference

09511-037

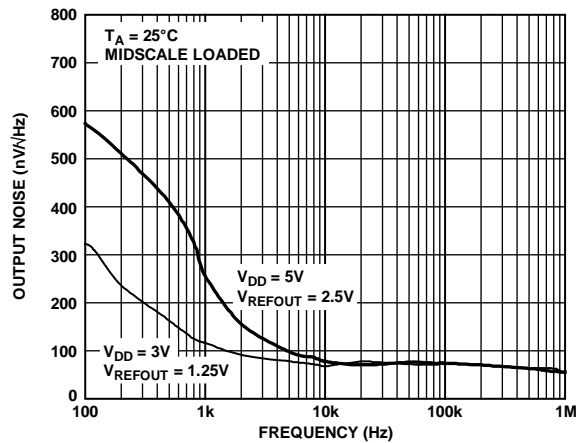

Figure 35. Noise Spectral Density, Internal Reference

09511-040

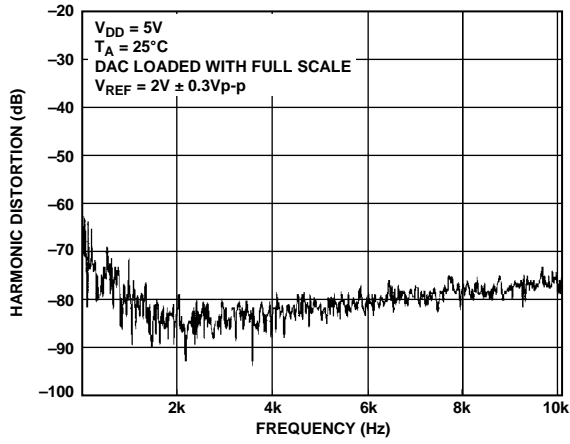

Figure 36. Total Harmonic Distortion

09511-041

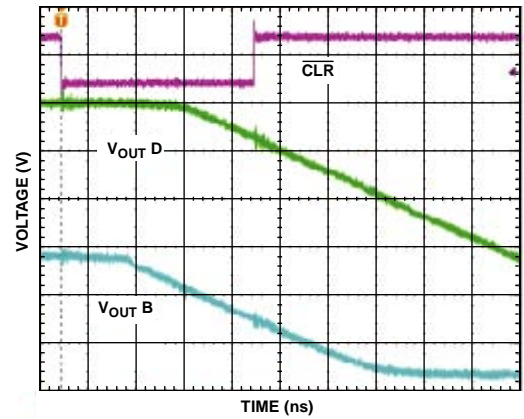

Figure 38. Hardware \overline{CLR}

09511-043

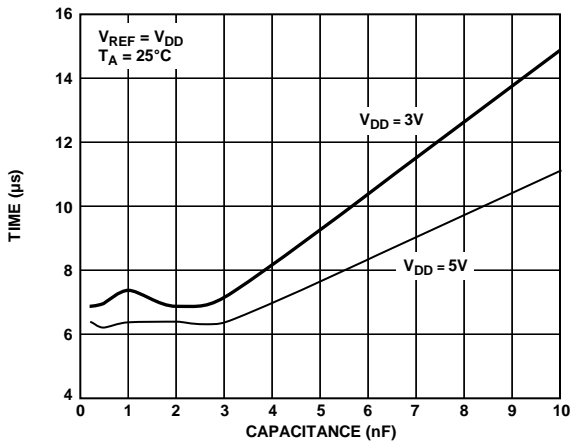

Figure 37. Settling Time vs. Capacitive Load

09511-042

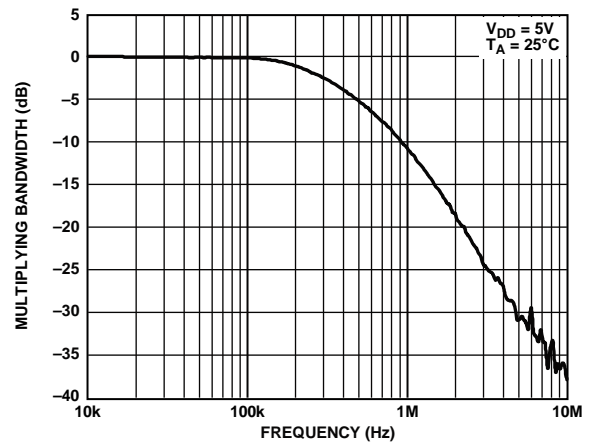
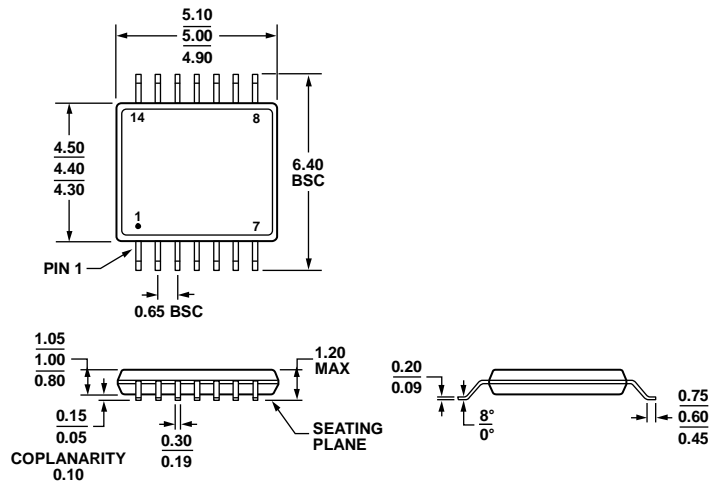

Figure 39. Multiplying Bandwidth

09511-044

AD5666-EP

OUTLINE DIMENSIONS



COMPLIANT TO JEDEC STANDARDS MO-153-AB-1

Figure 40. 14-Lead Thin Shrink Small Outline Package [TSSOP] (RU-14)

Dimensions shown in millimeters

061908-A

ORDERING GUIDE

Model ¹	Power-On Reset to Code	Accuracy	Internal Reference	Temperature Range	Package Description	Package Option
AD5666SRU-EP-2RL7	Zero	±21 LSB INL	2.5 V	-55°C to +125°C	14-Lead TSSOP	RU-14

¹ Z = RoHS Compliant Part.

Mouser Electronics

Authorized Distributor

Click to View Pricing, Inventory, Delivery & Lifecycle Information:

[Analog Devices Inc.:](#)

[EVAL-AD5666EBZ](#) [AD5666BRUZ-2](#) [AD5666BRUZ-1](#) [AD5666ARUZ-2REEL7](#) [AD5666BRUZ-1REEL7](#)
[AD5666BRUZ-2REEL7](#) [AD5666ARUZ-2](#) [EVAL-AD5666SDZ](#)