



FSY50X05L(M)(H) FSY50X12L(M)(H) FSY50X24L(M)(H)

Features

Size: 50×50×10mm(1.97×1.97×0.39in)

Frame/Impeller: Reinforced Plastic UL94V-0

Bearings: Ball Bearing&Sleeve Bearing

Life Expectancy:50,000 Hours at 20°C-Ball
30,000 Hours at 20°C-Sleeve

Approvals: UL CUL TUV CE RoHS

Weight: 18g

 E318377 CE TUV AE50078978

▪ RoHS Compliant

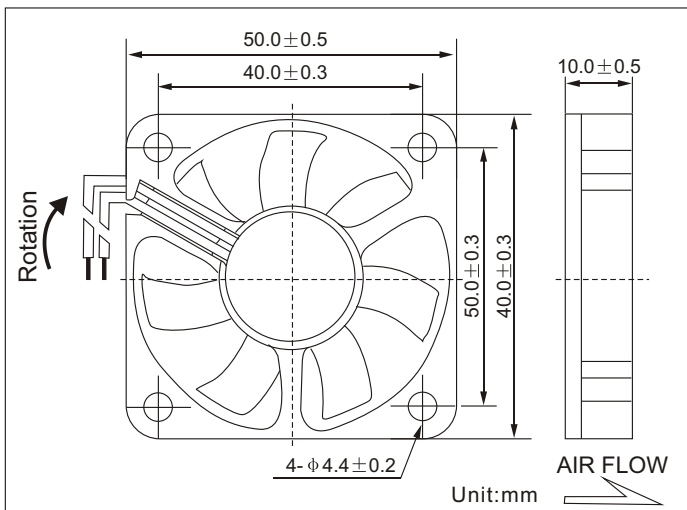

Air Flow vs Air Pressure

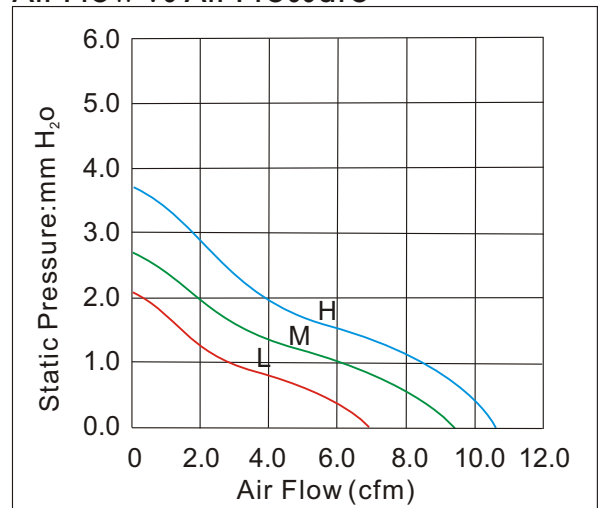

Performance

Model	Bearing System X			Rated Voltage (V)	Current (A)	Input Power (W)	Nominal Speed (R.P.M)	Air Flow (CFM)	Air Pressure (mm-H ₂ O)	Noise (dBA)
	S	B	D							
FSY50X05L	✓	✓	✓	5	0.15	0.75	4000	7.20	2.02	21
FSY50X05M	✓	✓	✓	5	0.20	1.00	5000	9.15	2.75	27
FSY50X05H	✓	✓	✓	5	0.25	1.25	6000	10.20	3.65	33
FSY50X12L	✓	✓	✓	12	0.08	0.96	4000	7.20	2.02	21
FSY50X12M	✓	✓	✓	12	0.10	1.20	5000	9.15	2.75	27
FSY50X12H	✓	✓	✓	12	0.12	1.44	6000	10.20	3.65	33
FSY50X24L	✓	✓	✓	24	0.05	1.20	4000	7.20	2.02	21
FSY50X24M	✓	✓	✓	24	0.07	1.68	5000	9.15	2.75	27
FSY50X24H	✓	✓	✓	24	0.09	2.16	6000	10.20	3.65	33

Product specification contained herein may be changed without prior notice.

It is therefore advisable to contact FONSONING ELECTRONICS before proceeding with the design of equipment incorporating this product.

Fonsoning Electronics Corporation 4/F, Building 1, Fumin Yuexinwei Industrial District, Guanlan Town, Shenzhen
Tel: 86-755-28015525 • Fax: 86-755-89584557 • E-mail: fsy@fonsoning.com • www.fonsoning.com