



FSY51X05L(M)(H) FSY51X12L(M)(H) FSY51X24L(M)(H)

Features

Size: 50×50×15mm(1.97×1.97×0.59in)
 Frame/Impeller: Reinforced Plastic UL94V-0
 Bearings: Ball Bearing&Sleeve Bearing
 Life Expectancy:50,000 Hours at 20°C-Ball
 30,000 Hours at 20°C-Sleeve
 Approvals: UL CUL TUV CE RoHS
 Weight: 25g

 E318377 CE TUV AE50078978
 ▪ RoHS Compliant

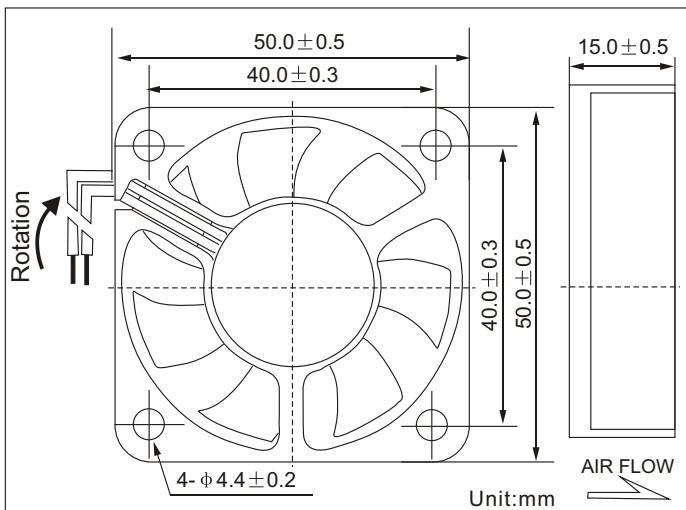

Air Flow vs Air Pressure

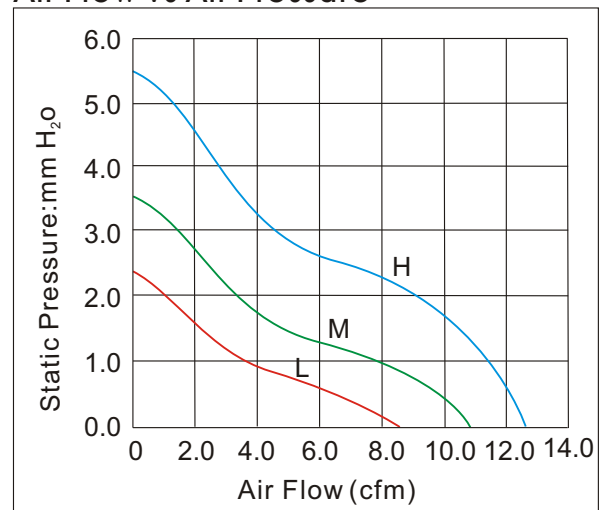

Performance

Model	Bearing System X			Rated Voltage (V)	Current (A)	Input Power (W)	Nominal Speed (R.P.M)	Air Flow (CFM)	Air Pressure (mm-H ₂ O)	Noise (dBA)
	S	B	D							
FSY51X05L	✓	✓	✓	5	0.22	1.10	4000	8.25	2.30	26
FSY51X05M	✓	✓	✓	5	0.25	1.27	5000	10.20	3.65	32
FSY51X05H	✓	✓	✓	5	0.28	1.40	6000	12.25	5.43	35
FSY51X12L	✓	✓	✓	12	0.10	1.20	4000	8.25	2.30	26
FSY51X12M	✓	✓	✓	12	0.13	1.56	5000	10.20	3.65	32
FSY51X12H	✓	✓	✓	12	0.15	1.80	6000	12.25	5.43	35
FSY51X24L	✓	✓	✓	24	0.06	1.44	4000	8.25	2.30	26
FSY51X24M	✓	✓	✓	24	0.08	1.92	5000	10.20	3.65	32
FSY51X24H	✓	✓	✓	24	0.10	2.40	6000	12.25	5.43	35

Product specification contained herein may be changed without prior notice.

It is therefore advisable to contact FONSONING ELECTRONICS before proceeding with the design of equipment incorporating this product.