

PART NAME: GROMMET

SCALE: 4:1

DATE: 9/19/16

DR. BY: MK



DESIGNERS & MANUFACTURERS
OF KNOBS, HANDLES, CAPS &
CUSTOM PLASTIC COMPONENTS

P/N 5102

THIS DRAWING IS THE PROPERTY OF DAVIES MOLDING COMPANY, IS SUBMITTED SOLELY AS A DESIGN OR ENGINEERING PROJECT.
WE ACCEPT NO RESPONSIBILITY WHATSOEVER FOR THE PRACTICAL APPLICATION OF THE PIECES MADE TO THIS DESIGN.

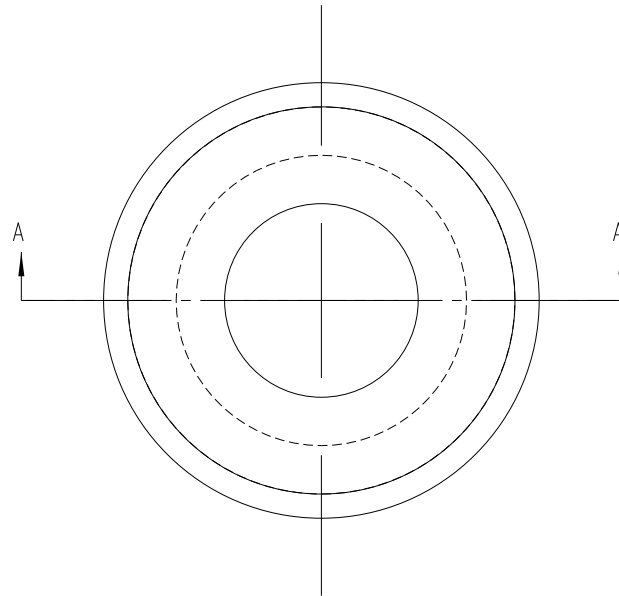

For use with panels of:
Max Thickness = 0.063"
Hole Dia. = 0.375"

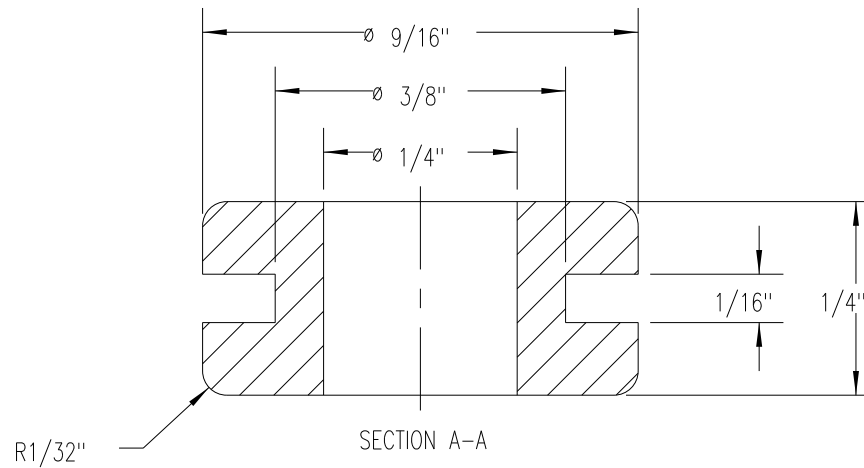

MATERIAL: NBR
COLOR: BLACK

TOLERANCES: UNLESS OTHERWISE SPECIFIED	DO NOT SCALE DRAWING				
DECIMALS: X.XXX ± .005 X.XX ± .015	MM: X.XX ± 0.15MM X.X ± 0.4MM				
FRACTIONS ± 1/64	ANG. ± 1°	CHANGES			

Mouser Electronics

Authorized Distributor

Click to View Pricing, Inventory, Delivery & Lifecycle Information:

[Davies Molding:](#)

[5102](#)