

54V_{IN} Dual 25A, Single 50A μModule Regulator with Digital Power System Management

FEATURES

- Complete 48V Input to Low Voltage Dual 25A Supply that Can Scale to 300A
- Dual Analog Loops with Digital Interface for Compensation, Control and Monitoring
- Input Voltage Range: 30V to 58V
- Output Voltage Range: 0.5V to 1.5V
- ±3% Output Current Readback Accuracy (–20° to 125°C)
- 88% Efficiency for 48V to 1V at 50A
- ±0.5% Output Voltage Accuracy Over Temperature
- 400kHz PMBus-Compliant I²C Serial Interface
- 16mm × 16mm × 7.72mm BGA Package

APPLICATIONS

- 48V Systems
- Computer and Networking Equipment
- Electronic Test Equipment
- Storage Systems

Click to view associated TechClip Videos.

DESCRIPTION

The LTM[®]4664 is a complete nonisolated 48V input high efficiency step-down μModule[®] regulator with dual 25A outputs. The switching controllers, power MOSFETs, inductors and supporting components are included. Only external capacitors are needed to complete the design. Operating over a 30V to 58V input voltage range, the LTM4664 supports an output voltage of 0.5V to 1.5V at up to 75W. An intermediate output at 25% • V_{IN} is also available. The LTM4664 product video is available on the website. [▶](#)

The LTM4664 dual 25A regulators utilize digitally programmable analog control loops, precision data acquisition circuitry and EEPROM with ECC. The LTM4664's 2-wire serial interface allows the 25A outputs to be margined, tuned and ramped up and down at programmable slew rates and sequencing delay times. True input current sense, output currents and voltages, input and output power, temperatures, uptime and peak values are all readable.

All registered trademarks and trademarks are the property of their respective owners. Protected by U.S. Patents including 5408150, 5481178, 5705919, 5929620, 6144194, 6177787, 6580258, 7420359, 8163643. Licensed under U.S. Patent 7000125 and other related patents worldwide.

TYPICAL APPLICATION

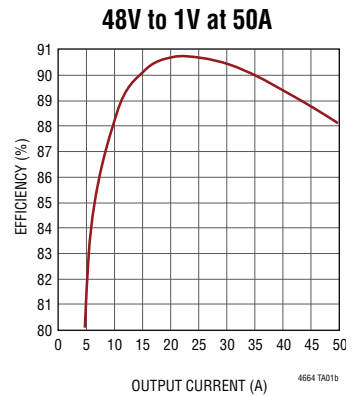
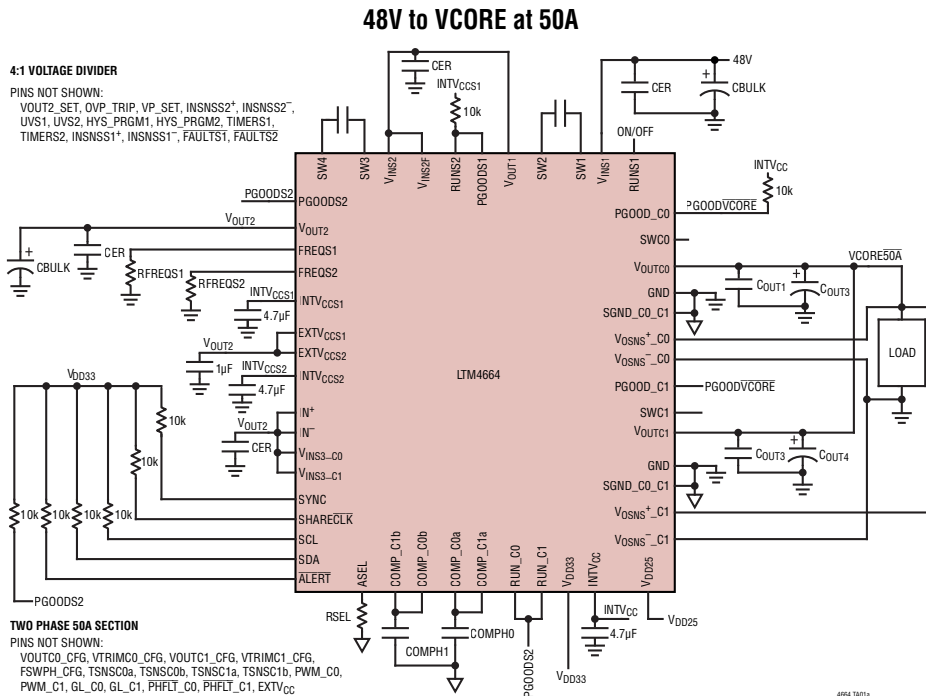

TABLE OF CONTENTS

Features	1	INTV _{CC} /EXTV _{CC} Power	40
Applications	1	Output Current Sensing and Sub Milliohm DCR	
Typical Application	1	Current Sensing	41
Description.....	1	Input Current Sensing	41
Table of Contents	2	PolyPhase Load Sharing	41
Absolute Maximum Ratings	4	External/Internal Temperature Sense	42
Order Information	4	RCONFIG (Resistor Configuration) Pins	42
Pin Configuration	4	Fault Detection and Handling	45
Electrical Characteristics	5	Status Registers and $\overline{\text{ALERT}}$ Masking	46
Typical Performance Characteristics	15	Mapping Faults to FAULT Pins	48
4:1 Divider Block Diagram	25	Power Good Pins	48
Dual 25A Power System Management (PSM)		CRC Protection	48
Block Diagram.....	26	Serial Interface	48
4:1 Divider Operation	27	Communication Protection	48
4:1 Divider Description	27	Device Addressing	48
Main Control.....	27	Responses to V _{OUT} and I _{IN} /I _{OUT} Faults	49
INTV _{CCS1,2} /EXTV _{CCS1,2} Power.....	27	Output Overvoltage Fault Response	49
Start-Up and Shutdown.....	28	Output Undervoltage Response	50
Fault Protection and Thermal Shutdown.....	28	Peak Output Overcurrent Fault Response	50
High Side Current Sensing.....	28	Responses to Timing Faults	50
Frequency Selection.....	28	Responses to V _{IN} OV Faults	50
Power Good and UV (PGOODS _n and UVS _n pins)....	29	Responses to OT/UT Faults	50
Additional Overvoltage Protection	29	Internal Overtemperature Fault Response	50
4:1 Divider Application Information.....	30	External Overtemperature and Undertemperature	
Voltage Divider Pre-Balance Before Switching.....	30	Fault Response	51
Overcurrent Protection	31	Responses to Input Overcurrent and Output	
Window Comparator Programming	31	Undercurrent Faults	51
Effective Open Loop Output Resistance and		Responses to External Faults	51
Load Regulation.....	32	Fault Logging	51
Undervoltage Lockout.....	32	Bus Timeout Protection	51
Fault Response and Timer Programming.....	32	Similarity Between PMBus, SMBus and I ² C	
Design Example	33	2-Wire Interface	52
Dual 25A PSM Operation	35	PMBus Serial Digital Interface	52
PSM Section Overview, Major Features	35	Figure 11 thru Figure 28 PMBus Protocols	54
EEPROM with ECC	36	PMBus Command Summary	57
Power-Up and Initialization	37	PMBus Commands	57
Soft-Start	38	Dual 25A PSM Applications Information	63
Time-Based Sequencing	38	V _{IN} to V _{OUT} Step-Down Ratios	63
Voltage-Based Sequencing	38	Input Capacitors	63
Shutdown	39	Output Capacitors	63
Light-Load Current Operation	39	Light Load Current Operation	63
Switching Frequency and Phase	40	Switching Frequency and Phase	64
PWM Loop Compensation	40	Output Current Limit Programming	65
Output Voltage Sensing	40	Minimum On-Time Considerations	66

TABLE OF CONTENTS

Variable Delay Time, Soft-Start and Output		Voltage.....	98
Voltage Ramping	66	Input Voltage and Limits.....	98
Digital Servo Mode	66	Output Voltage and Limits	99
Soft Off (Sequenced Off)	67	Output Current and Limits	102
Undervoltage Lockout	68	Input Current and Limits	104
Fault Detection and Handling	68	Temperature.....	105
Open-Drain Pins	68	External Temperature Calibration.....	105
Phase-Locked Loop and Frequency		Timing	106
Synchronization	69	Timing—On Sequence/Ramp.....	106
Input Current Sense Amplifier	70	Timing—Off Sequence/Ramp	107
Programmable Loop Compensation	70	Precondition for Restart	108
Checking Transient Response	71	Fault Response	108
PolyPhase® Configuration	72	Fault Responses All Faults	108
Connecting the USB to I ² C/SMBus/PMBus		Fault Responses Input Voltage.....	109
Controller to the LTM4664 In-System	72	Fault Responses Output Voltage	109
LTpowerPlay: An Interactive GUI for Digital Power .	73	Fault Responses Output Current.....	112
PMBus Communication and Command		Fault Responses IC Temperature	113
Processing	73	Fault Responses External Temperature.....	114
Thermal Considerations and Output Current		Fault Sharing.....	115
Derating	75	Fault Sharing Propagation	115
Table 10 and Table 11: Output Current Derating		Fault Sharing Response	117
(Based on Demo Board)	78	Scratchpad	117
Dual 25A PSM Applications Information—Derating		Identification.....	118
Curves	81	Fault Warning and Status.....	119
EMI Performance	82	Telemetry.....	127
Safety Considerations	82	NVM Memory Commands	131
Layout Checklist/Example	83	Store/Restore	131
Typical Applications	84	Fault Logging	132
PMBus Command Details	90	Block Memory Write/Read.....	136
Addressing and Write Protect.....	90	Package Description	137
General Configuration Commands.....	92	Revision History	139
On/Off/Margin	93	Typical Applications	140
PWM Configuration	95	Related Parts	140

ABSOLUTE MAXIMUM RATINGS

(Note 1)

4:1 Divider

V_{INS1} , SW1, SW2, INSNSS1⁺, INSNSS1⁻,
 $\overline{FAULTS1}$, $\overline{FAULTS2}$ -0.3V to 60V
 V_{INS2} , V_{INS2F} , INSNSS2⁺, INSNSS2⁻, PGOODS1,
 PGOODS2, EXTV_{CCS1}, EXTV_{CCS2}, SW3, SW4,
 OVP_SET, VOUT2_SET, OVP_TRIP, V_{OUT1} -0.3V to 40V
 V_{OUT2} 0.3V to 20V
 INTV_{CCS1}, INTV_{CCS2} OUTPUT ONLY, RATED 6V
 RUNS1, RUNS2 -0.3V to 6V
 UVS1, UVS2, HYS_PRGMS1, HYS_PRGMS2,
 TIMERS1, TIMERS2, FREQS1,
 FREQS2 -0.3V to INTV_{CCS1}, -0.3 to INTV_{CCS2}

DUAL 25A PSM SECTION

V_{INS3_Cn} , IN⁺, IN⁻ -0.3V to 18V
 ($V_{INS3_Cn} - IN^+$), (IN⁺ - IN⁻) -0.3V to 0.3V
 SWC0, SWC1 -1V to 18V, -5V to 18V Transient
 EXTV_{CC} -0.3V to 6V
 V_{OUTCn} -0.3V to 3.6V
 $V_{OSNS^+_Cn}$ -0.3V to 6V
 $V_{OSNS^-_Cn}$ -0.3V to 0.3V
 RUN_Cn, SDA, SCL, \overline{ALERT} -0.3V to 5.5V
 FSWPH_CFG, VOUTCn_CFG, VTRIMCn_CFG, ASEL,
 COMP_1a, COMP_1b, COMP_0a, COMP_0b -0.3V to 2.75V
 $\overline{FAULT_Cn}$, SYNC, SHARE_CLK, WP, PGOOD_Cn,
 PWM_Cn, PHFLT_Cn -0.3V to 3.6V
 TSNS_Cna, -0.3V to 2.2V
 TSNS_Cnb -0.3V to 0.8V, < 5mA
 OVP-SET I_{MAX} Sink 5mA
 INTV_{CC} V_{DD33}, V_{DD25} and GL_Cn are Outputs.
 Internal Operating Temperature

Range (Notes 2, 14, 15) -40°C to 125°C
 Storage Temperature Range -55°C to 125°C
 Peak Solder Reflow (Package Body) Temperature 245°C

PIN CONFIGURATION

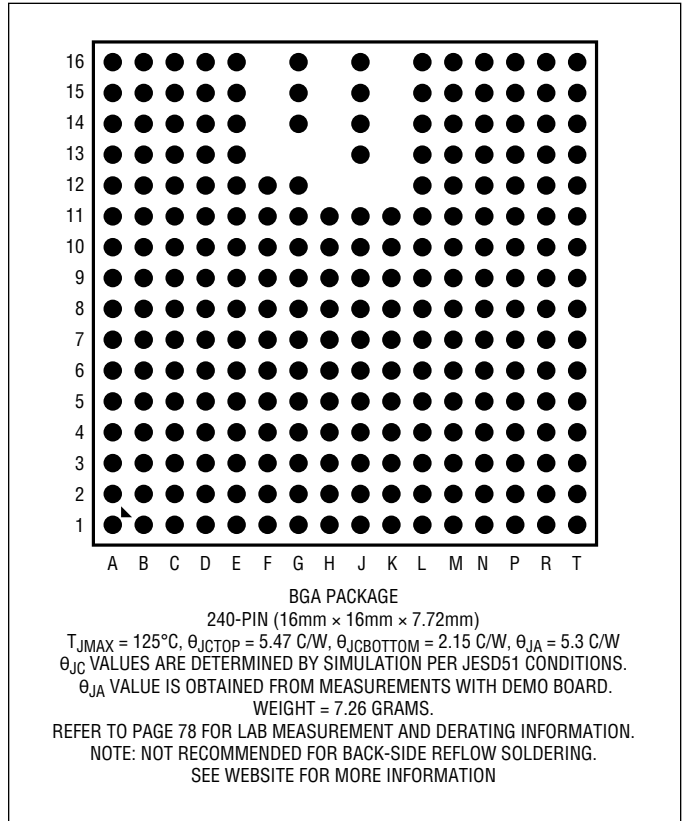

ORDER INFORMATION

PART NUMBER	PAD OR BALL FINISH	PART MARKING		PACKAGE TYPE	MSL RATING	TEMPERATURE RANGE (SEE NOTE 2)
		DEVICE	FINISH CODE			
LTM4664EY#PBF	SAC305 (RoHS)	LTM4664Y	e1	BGA	3	-40°C to 125°C
LTM4664IY#PBF		LTM4664Y				

• Contact the factory for parts specified with wider operating temperature ranges. *Pad or ball finish code is per IPC/JEDEC J-STD-609.

- [Recommended LGA and BGA PCB Assembly and Manufacturing Procedures](#)
- [LGA and BGA Package and Tray Drawings](#)

ELECTRICAL CHARACTERISTICS The ● denotes the specifications which apply over the internal operating junction temperature. $T_A = 25^\circ\text{C}$, $V_{\text{INS}1} = 48\text{V}$, and $\text{RUN}_n = 5\text{V}$ where $n = \text{stage \#}$ unless otherwise noted. See Figure 46 configuration for setup. (Note 3)

SYMBOL	PARAMETER	CONDITIONS	MIN	TYP	MAX	UNITS	
4:1 Divider Section							
$V_{\text{INS}1}$	Input DC Voltage Stage 1	Note 4		30	58	V	
$V_{\text{INS}2}$	Input DC Voltage Stage 2	Note 4		15	29	V	
$V_{\text{OUT}1}$ Range	$V_{\text{OUT}1}$ Output Range	Note 4		15	29	V	
$V_{\text{OUT}2}$ Range	$V_{\text{OUT}2}$ Output Range	Note 4		7.5V	14.5	V	
Maximum Power	Maximum Output Power	All Conditions, Note 4			75	W	
$V_{\text{OUT}1(\text{DC})}$	$V_{\text{OUT}1}$ OUTPUT	Note 4, Based on Figure 49 $V_{\text{INS}1} = 48\text{V}$, $\text{RUN} = 5\text{V}$, $I_{V_{\text{OUT}1}} = 0\text{A}$	●	23.5	24	24.5	V
$V_{\text{OUT}2(\text{DC})}$	$V_{\text{OUT}2}$ OUTPUT	Note 4, Based on Figure 49 $V_{\text{INS}2} = 24\text{V}$, $\text{RUN} = 5\text{V}$, $I_{V_{\text{OUT}2}} = 0\text{A}$	●	11.5	12	12.5	V
V_{UVLO}	Undervoltage Lockout	INTV_{CC} Falling INTV_{CC} Rising		4.85 5.05		V V	
$I_{\text{Q}} V_{\text{INS}n}$	$V_{\text{INS}1}$, $V_{\text{INS}2}$ Quiescent Current Each Stage	$\text{RUN}_n = 0\text{V}$ $\text{RUN}_n = 5\text{V}$, No Switching $\text{RUN}_n = 5\text{V}$, Switching		150 1.6 44		μA mA mA	
Overcurrent Protection Section							
$\text{INSNSS}1^+$	Stage 1 Current Sense ⁺	$\text{INSNSS}1^+ = \text{INSNSS}1^- = 60\text{V}$ $V_{\text{OUT}1} = 30\text{V}$, $\text{RUNS}1 = 5\text{V}$		220	350	μA	
$\text{INSNSS}2^+$	Stage 2 Current Sense ⁺	$\text{INSNSS}2^+ = \text{INSNSS}2^- = 30\text{V}$ $V_{\text{OUT}2} = 15\text{V}$, $\text{RUNS}2 = 5\text{V}$		220	350	μA	
$\text{INSNSS}1^-$	Stage 1 Current Sense ⁻	$\text{INSNSS}1^+ = \text{INSNSS}1^- = 60\text{V}$, $\text{RUNS}1 = 0\text{V}$	●	-5	1	5	μA
$\text{INSNSS}2^-$	Stage 2 Current Sense ⁻	$\text{INSNSS}2^+ = \text{INSNSS}2^- = 30\text{V}$, $\text{RUNS}2 = 0\text{V}$	●	-5	1	5	μA
$\text{INSNSS}1$, $\text{INSNSS}2$ Threshold	Current Limit Threshold for Each Stage		●	45	50	55	mV
Pre Charge Balance							
$R_{V_{\text{INS}2\text{F}}}$	$V_{\text{INS}2}$ Resistance to GND	See Block Diagram (Note 10)		1		M Ω	
$R_{V_{\text{F}2}}$	Resistance Between Pins $V_{\text{INS}2}$ to $V_{\text{INS}2\text{F}}$	See Block Diagram Part of a RC Filter Stage 2		1		k Ω	
$\text{INSNSS}1^+$ Balance Current	Stage 1 Current Sense + Source	Pre-Balance Phase $V_{\text{INS}1} = 60\text{V}$ $\text{INSNSS}1^+ = \text{INSNSS}1^- = 60\text{V}$, $V_{\text{OUT}1} = 15\text{V}$, Timer = 1V		95		mA	
$\text{INSNSS}2^+$ Balance Current	Stage 2 Current Sense + Source	Pre-Balance Phase $V_{\text{INS}2} = 30\text{V}$ $\text{INSNSS}2^+ = \text{INSNSS}2^- = 30\text{V}$, $V_{\text{OUT}2} = 10\text{V}$, Timer = 1V		95		mA	
$I_{\text{SOURCE}} V_{\text{OUT}n}$	I_{SOURCE} Current to Pre-Start Up Balance $V_{\text{OUT}n}$ and $C_{\text{FLY}n}$, $n = \text{Stage \#}$	$\text{INSNSS}n = V_{\text{INS}n} = 24\text{V}$ $V_{\text{OUT}n} = 10\text{V}$, Timer = 0.8V See Block Diagram		95		mA	
$I_{\text{SINK}} V_{\text{OUT}n}$	I_{SINK} Current to Pre-Start Up Balance $V_{\text{OUT}n}$ and $C_{\text{FLY}n}$, $n = \text{Stage \#}$	$\text{INSNSS}n = V_{\text{INS}n} = 24\text{V}$ $V_{\text{OUT}n} = 11\text{V}$, Timer = 0.8V See Block Diagram		50		mA	
RUNn Pins							
$V_{\text{TH-RUN}n}$	Run PIN Threshold $n = \text{Stage \#}$	V_{RUN} Rising	●	1.1	1.22	1.4	V
$V_{\text{RUN}n}$ HYS	Run Pin Hysteresis $n = \text{Stage \#}$			90		mV	

ELECTRICAL CHARACTERISTICS The ● denotes the specifications which apply over the internal operating junction temperature. $T_A = 25^\circ\text{C}$, $V_{\text{INS}1} = 48\text{V}$, and $\text{RUN}n = 5\text{V}$ where $n = \text{stage \#}$ unless otherwise noted. See Figure 46 configuration for setup. (Note 3)

SYMBOL	PARAMETER	CONDITIONS	MIN	TYP	MAX	UNITS
OVP Comparator						
OVP-SET In	OVP-SET Input Range MAX			25		V
$V_{\text{OUT}2\text{-SET}}$	$V_{\text{OUT}2\text{-SET}}$ Range MAX			25		V
I_B	Input Bias I	$V_{\text{CM}} = 0\text{V to } 25\text{V}$		30		mA
V_{OS}	Input Offset	$0.5\text{V} < V_{\text{CM}} < 25\text{V}$		3		mV
PSRR	Power Supply Rejection	$0.5\text{V} < V_{\text{CM}} < 25\text{V}$ (Note 10)		85		db
CMRR	Common Mode Rejection	$0.5\text{V} < V_{\text{CM}} < 25\text{V}$ (Note 10)		80		db
Delay	Propagation Delay			10		μs
OVP_Trip Sink	OVP_Trip Sink	$I_{\text{SINK}} = 5\text{mA}$ (Note 10)		0.35		V
INTV_{CC} Regulators						
$V_{\text{INTV}_{\text{CC}n}}$	Internal (LDO) Low Drop Out Regulator, $n = \text{Stage \#}$	$30\text{V} < V_{\text{INS}1} < 58\text{V}$, $V_{\text{EXTV}_{\text{CC}1}} = 0\text{V}$, Stage 1 $15\text{V} < V_{\text{INS}2} < 19\text{V}$, $V_{\text{EXTV}_{\text{CC}2}} = 0\text{V}$, Stage 2	5.4	5.6	5.9	V
$V_{\text{INTV}_{\text{CC}n}}$ Load	LDO Load Regulation	$I_{\text{CC}} = 50\text{mA}$, $V_{\text{EXTV}_{\text{CC}n}} = 0\text{V}$		0.5	2	%
$\text{INTV}_{\text{CC}n}$ I _{Peak}	INTV_{CC} Stage Peak Output Current			150		mA
$V_{\text{INTV}_{\text{CC}n}}$ with EXTV_{CC}	LDO Output Range with $\text{EXTV}_{\text{CC}n}$, $n = \text{Stage \#}$	$12\text{V} < V_{\text{EXTV}_{\text{CC}n}} < 24\text{V}$, $V_{\text{INS}n} = 12\text{V}$	5.4	5.6	5.9	V
$V_{\text{INTV}_{\text{CC}n}}$ Load EXT	LDO Load Regulation with EXTV_{CC}	$I_{\text{CC}} = 50\text{mA}$, $V_{\text{EXTV}_{\text{CC}n}} = 6.5\text{V}$		1	2	%
$V_{\text{EXTV}_{\text{CC}n}}$ Threshold	$\text{EXTV}_{\text{CC}n}$ Switch Over	$V_{\text{EXTV}_{\text{CC}n}}$ Ramping Positive	6.3	6.5	6.65	V
$V_{\text{EXTV}_{\text{CC}n}}$ HYS	$\text{EXTV}_{\text{CC}n}$ Hysteresis			400		mV
Switching Oscillator						
Frequency Range n	Frequency Range	$n = \text{Stage \#}$	100		1000	kHz
f_{NOM} Stage 1	Optimized Efficiency Freq. Stage 1	FREQS1. Pin Resistor = 36.5k		100		kHz
f_{NOM} Stage 2	Optimized Efficiency Freq. Stage 2	FREQS2. Pin Resistor = 60.4k		200		kHz
Output Specifications						
$\Delta V_{\text{OUT}}/V_{\text{OUT}}$ Stage 1	Stage 1 Load Regulation Accuracy	$V_{\text{OUT}1} = 24\text{V}$, 0A to 3.2A Maximum = 75W $V_{\text{INS}1} = 48\text{V}$, FREQS1 = 100kHz $C_{\text{INB}1} = 33\mu\text{F}$ (Bulk Input Capacitor) $C_{\text{IN}1} = 2.2\mu\text{F}$ 100V Ceramic, $C_{\text{FLY}1} = 10\mu\text{F}$ 50V X6 $C_{\text{OUT}1} = 10\mu\text{F}$ 50V		3.5		%
$V_{\text{OUT}1}$ Output Load	$V_{\text{OUT}1}$ Max Load Current (Note 4)	$V_{\text{OUT}1} = 24\text{V}$, 0A to 3.2A Maximum = 75W $V_{\text{INS}1} = 48\text{V}$, FREQS1 = 100kHz $C_{\text{INB}1} = 33\mu\text{F}$ (Bulk Input Capacitor) $C_{\text{IN}1} = 2.2\mu\text{F}$ 100V Ceramic, $C_{\text{FLY}1} = 10\mu\text{F}$ 50V X6 $C_{\text{OUT}1} = 10\mu\text{F}$ 50V			3.2	A
M1-M4 RDS-ON	Stage 1 MOSFET On Resistance	$V_{\text{GS}} = 5\text{V}$ (Note 16)		18		m Ω
$\Delta V_{\text{OUT}}/V_{\text{OUT}}$ Stage 2	Stage 2 Load Regulation Accuracy	$V_{\text{OUT}2} = 12\text{V}$, 0A to 6.3A Maximum = 75W $V_{\text{INS}2} = 24\text{V}$, FREQS2 = 200kHz $C_{\text{INB}2} = 33\mu\text{F}$ (Bulk Input Capacitor) $C_{\text{IN}2} = 10\mu\text{F}$ 50V Ceramic, $C_{\text{FLY}2} = 22\mu\text{F}$ 25V X6, $C_{\text{OUT}2} = 22\mu\text{F}$ 25V		5		%
$V_{\text{OUT}2}$ Output Load	$V_{\text{OUT}2}$ Max Load Current (Note 4)	$V_{\text{OUT}2} = 12\text{V}$, 0A to 6.3A Maximum = 75W $V_{\text{INS}2} = 24\text{V}$, FREQS2 = 200kHz $C_{\text{INB}2} = 33\mu\text{F}$ (Bulk Input Capacitor) $C_{\text{IN}2} = 10\mu\text{F}$ 50V Ceramic, $C_{\text{FLY}2} = 22\mu\text{F}$ 25V X6, $C_{\text{OUT}2} = 22\mu\text{F}$ 25V			6.3	A

ELECTRICAL CHARACTERISTICS The ● denotes the specifications which apply over the internal operating junction temperature. $T_A = 25^\circ\text{C}$, $V_{\text{INS}1} = 48\text{V}$, and $\text{RUN}n = 5\text{V}$ where $n = \text{stage \#}$ unless otherwise noted. See Figure 46 configuration for setup. (Note 3)

SYMBOL	PARAMETER	CONDITIONS	MIN	TYP	MAX	UNITS
M5-M8 RDS-ON	Stage 2 MOSFET On Resistance	$V_{\text{GS}} = 5\text{V}$ (Note 16)		10		$\text{m}\Omega$
$V_{\text{OUT}1, (\text{AC})}$	Output Ripple Voltage	$V_{\text{OUT}1} = 24\text{V}$, 0A to 3A $V_{\text{INS}1} = 48\text{V}$, $\text{FREQS}1 = 100\text{kHz}$ $C_{\text{INB}1} = 33\mu\text{F}$ (Input Bulk Capacitor) $C_{\text{IN}1} = 2.2\mu\text{F}$ 100V Ceramic, $C_{\text{FLY}1} = 10\mu\text{F}$ 50V X6 $C_{\text{OUT}1} = 10\mu\text{F}$ 50V		150		$\text{mV}_{\text{pk-pk}}$
$V_{\text{OUT}2, (\text{AC})}$	Output Ripple Voltage	$V_{\text{OUT}2} = 12\text{V}$, 0A to 6A $V_{\text{INS}2} = 12\text{V}$, $\text{FREQS}2 = 200\text{kHz}$ $C_{\text{INB}2} = 33\mu\text{F}$ (Input Bulk Capacitor) $C_{\text{IN}2} = 10\mu\text{F}$ 50V Ceramic, $C_{\text{FLY}2} = 22\mu\text{F}$ 25V X6, $C_{\text{OUT}2} = 22\mu\text{F}$ 25V		50		$\text{mV}_{\text{pk-pk}}$
t_{START} Stage 1	Turn-on Time From RUN 1	$V_{\text{OUT}1} = 0\text{V}$ at Start Up to 24V, 0A, $V_{\text{INS}1} = 48\text{V}$, $\text{FREQS}1 = 100\text{kHz}$ $C_{\text{INB}1} = 33\mu\text{F}$ (Input Bulk Capacitor) $C_{\text{IN}1} = 2.2\mu\text{F}$ 100V Ceramic, $C_{\text{FLY}1} = 10\mu\text{F}$ 50V X6 $C_{\text{OUT}1} = 10\mu\text{F}$ 50V, $C_{\text{TIMER}1} = 0.22\mu\text{F}$		40		msec
t_{START} Stage 2	Turn-on Time Stage 2 From RUN 2	$V_{\text{OUT}2} = 0\text{V}$ at Start Up to 12V, 0A, $V_{\text{INS}2} = 24\text{V}$, $\text{FREQS}2 = 200\text{kHz}$ $C_{\text{INB}2} = 33\mu\text{F}$ (Input Bulk Capacitor) $C_{\text{IN}1} = 2.2\mu\text{F}$ 100V Ceramic, $C_{\text{FLY}1} = 22\mu\text{F}$, 25V X6 $C_{\text{OUT}2} = 22\mu\text{F}$ 25V, $C_{\text{TIMER}2} = 0.47\mu\text{F}$		75		msec

HYS_PRGMn and FAULTSn

$V_{\text{FAULTS}n}$	FAULT Voltage Low	$I_{\text{FAULT}} = 2\text{mA}$		0.2	0.4	V	
$I_{\text{FAULT_LEAKS}n}$	FAULT Leakage Current	$V_{\text{FAULT}} = 5\text{V}$			± 1	μA	
$I_{\text{HYS_PRGMS}n}$	HYS_PRGM Setting Current		●	9	10	11	μA
$V_{\text{FAULTS}n}$	$V_{\text{OUTS}n}$ Fault Trip Level	$V_{\text{INS}n} = 24\text{V}$, $V_{\text{OUT}n}$, $\text{HYS_PRGMS}n = 0\text{V}$, $V_{\text{OUTS}n}$ Ramp Up $V_{\text{OUTS}n}$ Ramp Down	● ●	12.2 11.6	12.3 11.7	12.45 11.8	V V
$V_{\text{FAULTS}n}$	$V_{\text{OUTS}n}$ Fault Trip Level	$V_{\text{INS}n} = 24\text{V}$, $V_{\text{OUT}n}$, $\text{HYS_PRGMS}n = 5\text{V}$, $V_{\text{OUTS}n}$ Ramp Up $V_{\text{OUTS}n}$ Ramp Down	● ●	12.7 11.1	12.8 11.2	12.9 11.3	V V
$V_{\text{FAULTS}n}$	$V_{\text{OUTS}n}$ Fault Trip Level	$V_{\text{INS}n} = 24\text{V}$, $V_{\text{OUT}n}$, $\text{HYS_PRGMS}n = 2.4\text{V}$, $V_{\text{OUTS}n}$ Ramp Up $V_{\text{OUTS}n}$ Ramp Down	● ●	14.15 9.5	14.3 9.65	14.45 9.8	V V

UV COMPARATORn and PGOODn

$V_{\text{UVTHSS}n}$	Undervoltage Threshold	UV Pin Voltage Rising		0.99	1.01	1.03	V
$V_{\text{HYS_PRGMS}n}$	Undervoltage Hysteresis			120			mV
$V_{\text{PGOODS}n}$	PGOOD Voltage Low	$I_{\text{PGOOD}} = 2\text{mA}$		0.35	0.5		V
$I_{\text{PGOODS}n_LEAK}$	PGOOD Leakage Current	$V_{\text{PGOOD}} = 5\text{V}$			± 1		μA

TimerSn

TimerSn Current	$I_{\text{TIMER}n}$	$V_{\text{TIMER}} < 0.5\text{V}$ or $V_{\text{TIMER}} > 1.2\text{V}$		3.5			μA
		$0.5\text{V} < V_{\text{TIMER}} < 1.2\text{V}$		7			μA

ELECTRICAL CHARACTERISTICS The ● denotes the specifications which apply over the specified internal operating temperature range (Note 1, 2, 3). Specified as each individual output channel designated with n (Note 3). $T_A = 25^\circ\text{C}$, $V_{\text{INS}3} = 12\text{V}$, $\text{RUN_C}n = 3.3\text{V}$, $\text{EXTV}_{\text{CC}} = 0\text{V}$, $\text{FREQUENCY_SWITCH} = 350\text{kHz}$ and $V_{\text{OUTC}n}$ commanded to 1.000V unless otherwise noted. Configured with factory default EEPROM settings, unless otherwise noted.

SYMBOL	PARAMETER	CONDITIONS	MIN	TYP	MAX	UNITS	
DUAL 25A PSM OUTPUT							
$V_{\text{INS}3}$	Input DC Voltage Operating		●	7	16	V	
$V_{\text{OUTC}n}$	Range of Output Voltage Regulation	$V_{\text{OUTC}n}$ Diff Sensed on $V_{\text{OSNS}^+_{\text{C}n}}/V_{\text{OSNS}^-_{\text{C}n}}$ -Pin-Pair; Commanded by Serial Bus or with Resistors Present at Start-Up on $V_{\text{OUTC}n_CFG}$, Differential Remote Sense Path Voltage (Notes 4, 6)	●	0.5	1.5	V	
$V_{\text{OUTC}n(\text{DC})}$	Output Voltage, Total Variation with Line and Load	Digital Servo Engaged ($\text{MFR_PWM_MODE}n[6] = 1\text{b}$) Digital Servo Disengaged ($\text{MFR_PWM_MODE}n[6] = 0\text{b}$) $V_{\text{OUTC}n_CFG}$ Commanded to 1.000V , $V_{\text{OUTC}n}$ Low Range ($\text{MFR_PWM_MODE}n[1] = 1\text{b}$) (Note 6)	●	0.995	1.000	1.005	V
$V_{\text{INS}3 \text{ UVLO}}$	Undervoltage Lockout Threshold	$V_{\text{INTV}_{\text{CC}}}$ Falling $V_{\text{INTV}_{\text{CC}}}$ Rising		3.55	3.9	V	
$I_{\text{INRUSH}}(\text{VINS}3)$	Input Inrush Current at Start-Up	$V_{\text{OUTC}n} = 1\text{V}$, $V_{\text{INS}3} = 12\text{V}$; No Load Besides Capacitors; $\text{TON_RISE}n = 3\text{ms}$		400		mA	
$I_{\text{S}}(\text{VINS}3, \text{DCM})$	Input Supply Current in Discontinuous Mode Operation	Discontinuous Mode, $\text{MFR_PWM_MODE}n[0] = 0\text{b}$, $I_{\text{OUTC}n} = 100\text{mA}$		60		mA	
$I_{\text{S}}(\text{VINS}3, \text{FCM})$	Input Supply Current in Forced-Continuous Mode Operation	Forced Continuous Mode, $\text{MFR_PWM_MODE}n[0] = 1\text{b}$ $I_{\text{OUT}n} = 100\text{mA}$ $I_{\text{OUT}n} = 25\text{A}$, $V_{\text{INS}3} = 12\text{V}$, $V_{\text{OUT}n} = 1\text{V}$		80	2.3	mA	
$I_{\text{S}}(\text{VINS}3, \text{SHUTDOWN})$	Input Supply Current in Shutdown	Shutdown, $\text{RUN_C}n = 0\text{V}$		25		mA	
Output Specifications							
$I_{\text{OUTC}n}$	Output Continuous Current Range	Utilizing $\text{MFR_PWM_MODE}[7] = 0$, and Using $\sim I_{\text{OUT}} = 34\text{A}$, Page 103, (Note 4)		0	25	A	
$\frac{\Delta V_{\text{OUT}n(\text{LINE})}}{V_{\text{OUT}n}}$	Line Regulation Accuracy	Digital Servo Engaged ($\text{MFR_PWM_MODE}n[6] = 0\text{b}$) Digital Servo Disengaged ($\text{MFR_PWM_MODE}n[6] = 0\text{b}$) Open Circuit; $I_{\text{OUTC}n} = 0\text{A}$, $7\text{V} \leq V_{\text{IN}} \leq 16\text{V}$, V_{OUT} Low Range ($\text{MFR_PWM_MODE}n[1] = 1\text{b}$), $\text{FREQUENCY_SWITCH} = 350\text{kHz}$ (Note 6)		0.03	0.03	± 0.2	%/V
$\frac{\Delta V_{\text{OUT}n(\text{LOAD})}}{V_{\text{OUT}n}}$	Load Regulation Accuracy	Digital Servo Engaged ($\text{MFR_PWM_MODE}n[6] = 1\text{b}$) Digital Servo Disengaged ($\text{MFR_PWM_MODE}n[6] = 0\text{b}$) $0\text{A} \leq I_{\text{OUT}n} \leq 25\text{A}$, V_{OUT} Low Range, ($\text{MFR_PWM_MODE}n[1] = 1\text{b}$) (Note 6)	●	0.03	0.2	0.5	%
$V_{\text{OUT}n(\text{AC})}$	Output Voltage Ripple			10		mV	
f_{S} (Each Channel)	$V_{\text{OUTC}n}$ Ripple Frequency	FREQUENCY_SWITCH Set to 350kHz (0xFABC)	●	320	350	380	kHz
$\Delta V_{\text{OUTC}n(\text{START})}$	Turn-On Overshoot	$\text{TON_RISE}n = 3\text{ms}$ (Note 7)		8		mV	
t_{START}	Turn-On Start-Up Time	Time from V_{IN} Toggling from 0V to 12V to Rising Edge $\text{PGOOD_C}n$, $\text{TON_DELAY}n = 0\text{ms}$, $\text{TON_RISE}n = 3\text{ms}$		30		ms	
$t_{\text{DELAY}}(0\text{ms})$	Turn-On Delay Time	Time from First Rising Edge of $\text{RUN_C}n$ to Rising Edge of $\text{PGOOD_C}n$. $\text{TON_DELAY}n = 0\text{ms}$, $\text{TON_RISE}n = 3\text{ms}$, $V_{\text{INS}3}$ Having Been Established for at Least 70ms	●	2.9	3.3	3.7	ms
$\Delta V_{\text{OUT}n(\text{LS})}$	Peak Output Voltage Deviation for Dynamic Load Step	Load: 0A to 12.5A and 12.5A to 0A at $12.5\text{A}/\mu\text{s}$, $V_{\text{OUT}n} = 1\text{V}$, $V_{\text{INS}3} = 12\text{V}$ (Note 7) See Load Transient Graph		40		mV	
t_{SETTLE}	Settling Time for Dynamic Load Step	Load: 0A to 12.5A and 12.5A to 0A at $12.5\text{A}/\mu\text{s}$, $V_{\text{OUT}n} = 1\text{V}$, $V_{\text{INS}3} = 12\text{V}$ (Note 7) See Load Transient Graph		30		μs	

ELECTRICAL CHARACTERISTICS The ● denotes the specifications which apply over the specified internal operating temperature range (Note 1, 2, 3). Specified as each individual output channel designated with n (Note 3). $T_A = 25^\circ\text{C}$, $V_{\text{INS}3} = 12\text{V}$, $\text{RUN_C}n = 3.3\text{V}$, $\text{EXTV}_{\text{CC}} = 0\text{V}$, $\text{FREQUENCY_SWITCH} = 350\text{kHz}$ and $V_{\text{OUTC}n}$ commanded to 1.000V unless otherwise noted. Configured with factory default EEPROM settings, unless otherwise noted.

SYMBOL	PARAMETER	CONDITIONS	MIN	TYP	MAX	UNITS
$I_{\text{OUT}n(\text{OCL_AVg})}$	Output Current Limit, Time Averaged	Time-Averaged Output Inductor Current Limit Inception Threshold, Commanded by $I_{\text{OUT_OC_FAULT_LIMIT}n}$ (Note 7) Utilizing $\text{MFR_PWM_MODE}[7] = 0\text{b}$, and Using $\sim I_{\text{OUT}} = 34\text{A}$, Page103		34		A

Control Section

$V_{\text{FBCM}n}$	Feedback Input Common Mode Range	$V_{\text{OSNS}^-_Cn}$ Valid Input Range (Referred to SGND) $V_{\text{OSNS}^+_Cn}$ Valid Input Range (Referred to SGND)	●	-0.1	0.3	V
$V_{\text{OUT}n\text{-RNG}L}$	Full-Scale Command Voltage Range Low (0.5V to 2.75V) Set Point Accuracy Resolution LSB Step Size	Limit Design to 1.5V Operating for Module $\text{MFR_PWM_MODE}n[1] = 1\text{b}$, $V_{\text{OUT}n}$ Commanded to 2.75V (Notes 8, 10)	●	-0.5	2.75 12 0.688	V % Bits mV
$V_{\text{OUT}n\text{-RNG}H}$	Full-Scale Command Voltage Range High (0.5V to 3.6V) Set Point Accuracy Resolution LSB Step Size	Limit Design to 1.5V Operating for Module $\text{MFR_PWM_MODE}n[1] = 0\text{b}$, $V_{\text{OUT}n}$ Commanded to 3.60V (Notes 8, 10)	●	-0.5	3.60 12 1.375	V % Bits mV
$R_{\text{VSENSE}n^+}$	$V_{\text{OSNS}^+_Cn}$ Impedance to SGND	$0.05\text{V} \leq V_{\text{OSNS}^+_Cn} - V_{\text{SGND}} \leq 3.3\text{V}$		50		k Ω
$t_{\text{ON}(\text{MIN})}$	Minimum On-Time	(Note 10)		60		nsec
$g_{m0,1}$	Resolution Error Amplifier $g_{m(\text{max})}$ Error Amplifier $g_{m(\text{min})}$ LSB Step Size	$\text{COMP}0,1 = 1.35\text{V}$, $\text{MFR_PWM_CONFIG}[7:5] = 0$ to 7 MFR_PWW_CONFIG Section (Note 10)		3 5.76 1 0.68		Bits mmho mmho mmho
$R_{\text{COMP}0,1}$	Resolution Compensation Resistor $R_{\text{COMP}(\text{MAX})}$ Compensation Resistor $R_{\text{COMP}(\text{MIN})}$	$\text{MFR_PWM_CONFIG}[4:0] = 0$ to 31 (See Figure 1, Note 10)		5 62 0.5		Bits k Ω k Ω

Analog OV/UV Ch 0, 1 (Overvoltage/Undervoltage) Output Voltage Supervisor Comparators ($V_{\text{OUT_OV/UV_FAULT_LIMIT}}$ and $V_{\text{OUT_OV/UV_WARN_LIMIT}}$ Monitors)

$N_{\text{OV/UV_COMP}}$	Resolution, Output Voltage Supervisors	(Notes 9, 10)		9		Bits
$V_{\text{OV-RNG}}$	Output OV Comparator Threshold Detection Range	(Notes 9, 10) Limit Design to 1.5V Operating for Module Low Range Scale, $\text{MFR_PWM_MODE}n[1] = 1\text{b}$ High Range Scale, $\text{MFR_PWM_MODE}n[1] = 0\text{b}$		0.5 1	2.7 3.6	V V
V_{OUSTP}	Output OV and UV Comparator Threshold Programming LSB Step Size	(Notes 9, 10) Low Range Scale, $\text{MFR_PWM_MODE}n[1] = 1\text{b}$ High Range Scale, $\text{MFR_PWM_MODE}n[1] = 0\text{b}$		5.6 11.2		mV mV
$V_{\text{OV-ACC-C}n}$	Output OV Threshold Accuracy Range Low Range High	(Notes 9, 10) $0.5\text{V} \leq V_{\text{OSNS}^+_Cn} - V_{\text{OSNS}^-_Cn} \leq 2.7\text{V}$, $\text{MFR_PWM_MODE}n[1] = 1\text{b}$ $1\text{V} \leq V_{\text{OSNS}^+_Cn} - V_{\text{OSNS}^-_Cn} \leq 3.6\text{V}$, $\text{MFR_PWM_MODE}n[1] = 0\text{b}$	●		± 40 ± 1.5	mV %

ELECTRICAL CHARACTERISTICS The ● denotes the specifications which apply over the specified internal operating temperature range (Note 1, 2, 3). Specified as each individual output channel designated with n (Note 3). $T_A = 25^\circ\text{C}$, $V_{\text{INS}3} = 12\text{V}$, $\text{RUN_C}n = 3.3\text{V}$, $\text{EXTV}_{\text{CC}} = 0\text{V}$, $\text{FREQUENCY_SWITCH} = 350\text{kHz}$ and $V_{\text{OUTC}n}$ commanded to 1.000V unless otherwise noted. Configured with factory default EEPROM settings, unless otherwise noted.

SYMBOL	PARAMETER	CONDITIONS	MIN	TYP	MAX	UNITS
$V_{\text{UV-RNG}}$	Output UV Comparator Threshold Detection Range	(Note 10) Limit Design to 1.5V Operating for Module Low Range Scale, $\text{MFR_PWM_MODE}n[1] = 1\text{b}$ High Range Scale, $\text{MFR_PWM_MODE}n[1] = 0\text{b}$	0.5 1		2.7 3.6	V V
$V_{\text{UV-ACC } Cn}$	Output UV Threshold Accuracy Range Low Range High	(Notes 9, 10) $0.5\text{V} \leq V_{\text{VOSNS}^+_{Cn}} - V_{\text{VOSNS}^-_{Cn}} \leq 2.7\text{V}$, $\text{MFR_PWM_MODE}n[1] = 1\text{b}$ $1\text{V} \leq V_{\text{VOSNS}^+_{Cn}} - V_{\text{VOSNS}^-_{Cn}} \leq 3.6\text{V}$, $\text{MFR_PWM_MODE}n[1] = 0\text{b}$			± 40 ± 1.5	mV %
$t_{\text{PROP-OV}}$	Output OV Comparator Response Times	Overdrive to 10% Above Programmed Threshold			100	μs
$t_{\text{PROP-UV}}$	Output UV Comparator Response Times	Underdrive to 10% Below Programmed Threshold			100	μs

Analog OV/UV $V_{\text{INS}3}$ Input Voltage Supervisor Comparators (Threshold Detectors for VIN_ON and VIN_OFF)

$N_{\text{VINS3-OV/UV-COMP}}$	$V_{\text{INS}3}$ OV/UV Comparator Threshold-Programming Resolution	(Notes 9, 10)		9		Bits
$V_{\text{INS3-OU-RANGE}}$	$V_{\text{INS}3}$ OV/UV Comparator Threshold-Programming Range	ABS MAX = 18V for Module Design	●	4.5	16	V
$V_{\text{INS3-OU-STP}}$	$V_{\text{INS}3}$ OV/UV Comparator Threshold-Programming LSB Step Size	(Note 10)		76		mV
$V_{\text{INS3-OU-ACC}}$	$V_{\text{INS}3}$ OV/UV Comparator Threshold Accuracy	$4.5\text{V} < V_{\text{INS}3} \leq 16\text{V}$, Operating Range, 16V Max for Module	●		± 350	mV
$t_{\text{PROP-VINS3-LOW-VIN}}$	$V_{\text{INS}3}$ OV/UV Comparator Response Time, High V_{IN} Operating Configuration	Test Circuit 1, and: $\text{VIN_ON} = 9\text{V}$; $V_{\text{INS}3}$ Driven from 8.775V to 9.225V $\text{VIN_OFF} = 9\text{V}$; $V_{\text{INS}3}$ Driven from 9.225V to 8.775V			100 100	μs μs
$t_{\text{PROP-VINS3-LOW-VIN}}$	$V_{\text{INS}3}$ OV/UV Comparator Response Time, Low V_{IN} Operating Configuration	Test Circuit 2, and: $\text{VIN_ON} = 4.5\text{V}$; $V_{\text{INS}3}$ Driven from 4.225V to 4.725V $\text{VIN_OFF} = 4.5\text{V}$; $V_{\text{INS}3}$ Driven from 4.725V to 4.225V			100 100	μs μs

Input Voltage ($V_{\text{INS}3}$) Readback (READ_VIN)

$N_{\text{VINS3-RB}}$	Input Voltage Readback Resolution and LSB Step Size	(Notes 5, 10)		10 15.625		Bits mV
$V_{\text{INS3-F/S}}$	Input Voltage Full-Scale Digitizable Range	(Notes 7, 11) 18V for Module Design		43		V
$V_{\text{INS3-RB-ACC}}$	Input Voltage Readback Accuracy	READ_VIN , $4.5\text{V} \leq V_{\text{INS}3} \leq 16\text{V}$, ($V_{\text{IN}} = V_{\text{INS}3}$)	●		2	%
$t_{\text{CONVERT-VINS3-RB}}$	Input Voltage Readback Update Rate	$\text{MFR_ADC_CONTROL} = 0.00$ (Notes 10, 12) $\text{MFR_ADC_CONTROL} = 0.01$ (Notes 10, 12)		90 8		ms ms

Channels 0 and 1 Output Voltage Readback ($\text{READ_VOUT}n$)

$N_{\text{VO-RB}}$	Output Voltage Readback Resolution and LSB Step Size	(Note 10)		16 244		Bits μV
$V_{\text{O-F/S}}$	Output Voltage Full-Scale Digitizable Range	$V_{\text{RUN}n} = 0\text{V}$ (Note 10) Design Limited to 1.5V		8		V
$V_{\text{O-RB-AC-C}n}$	Output Voltage Readback Accuracy	$0.5\text{V} \leq V_{\text{VOSNS}^+_{Cn}} - V_{\text{VOSNS}^-_{Cn}} \leq 1.0\text{V}$ $1\text{V} \leq V_{\text{VOSNS}^+_{Cn}} - V_{\text{VOSNS}^-_{Cn}} \leq 3.6\text{V}$	●		Within $\pm 5\text{mV}$, Reading Within $\pm 0.5\%$, Reading	

Channels 0 and 1 Output Current ($\text{READ_IOUT}n$)

$N_{\text{IO-RB}}$	Output Current Readback Resolution and LSB Step Size	(Notes 5, 10) Based on $\text{MFR_PWM_MODE}[7] = 1$ Using the $\text{OUT_OC_FAULT_LIMIT}$ of 34A		10 34.1		Bits mA
$I_{\text{O-F/S}}$	Output Current Full-Scale Digitizable Range	(Notes 5, 10) Based on $\text{MFR_PWM_MODE}[7] = 1$ Using the $\text{IOUT_OC_FAULT_LIMIT}$ of 40A		34		A

ELECTRICAL CHARACTERISTICS The ● denotes the specifications which apply over the specified internal operating temperature range (Note 1, 2, 3). Specified as each individual output channel designated with n (Note 3). $T_A = 25^\circ\text{C}$, $V_{\text{INS}3} = 12\text{V}$, $\text{RUN_C}n = 3.3\text{V}$, $\text{EXTV}_{\text{CC}} = 0\text{V}$, $\text{FREQUENCY_SWITCH} = 350\text{kHz}$ and $V_{\text{OUTC}n}$ commanded to 1.000V unless otherwise noted. Configured with factory default EEPROM settings, unless otherwise noted.

SYMBOL	PARAMETER	CONDITIONS	MIN	TYP	MAX	UNITS
$I_{\text{O-RB-ACC}}$	Output Current, Readback Accuracy	$\text{READ_IOUT}n$, Channels 0 and 1, $0 \leq I_{\text{OUT}n} \leq 25\text{A}$, Forced-Continuous Mode, $\text{MFR_PWM_MODE}n[0] = 1\text{b}$ With Offset Adjustment (-20°C to 125°C) (Note 7) See Histograms in Typical Performance Characteristics Section	●		5 3.5	% %
$I_{\text{O-RB}(25\text{A})}$	Full Load Output Current Readback	$I_{\text{OUT}n} = 25\text{A}$ Max by Module Design (Note 7)		25		A
$t_{\text{CONVERT-I0-RB}}$	Output Current Readback Update Rate	$\text{MFR_ADC_CONTROL} = 0 \times 00$ (Notes 10, 12) $\text{MFR_ADC_CONTROL} = 0 \times 06$ (CH0 I_{OUT}) or $0 \times 0A$ (CH1 I_{OUT}) (Notes 9, 17) See MFR_ADC_CONTROL Section		90 8		ms ms

Input Current Readback

N	Resolution	(Notes 5, 10)		10		Bits
V_{IINSTP}	LSB Step Size Full-Scale Range = 16mV LSB Step Size Full-Scale Range = 32mV LSB Step Size Full-Scale Range = 64mV	Gain = 8, $0\text{V} \leq V_{\text{IIN}^+} - V_{\text{IIN}^-} \leq 5\text{mV}$ Gain = 4, $0\text{V} \leq V_{\text{IIN}^+} - V_{\text{IIN}^-} \leq 20\text{mV}$ Gain = 2, $0\text{V} \leq V_{\text{IIN}^+} - V_{\text{IIN}^-} \leq 50\text{mV}$		15.26 30.52 61		μV μV μV
$I_{\text{IN_TUE}}$	Total Unadjusted Error	Gain = 8, $2.5\text{mV} \leq V_{\text{IIN}^+} - V_{\text{IIN}^-} $ (Note 13) Gain = 4, $4\text{mV} \leq V_{\text{IIN}^+} - V_{\text{IIN}^-} $ (Note 13) Gain = 2, $6\text{mV} \leq V_{\text{IIN}^+} - V_{\text{IIN}^-} $ (Note 13)	● ● ●		3.5 2.5 1.8	% % %
V_{OS}	Zero-Code Offset Voltage	(Note 10)			± 50	μV
t_{CONVERT}	Update Rate	(Note 12)		90		ms

Internal Controller Supply Current Readback $V_{\text{INS}3}$

N	Resolution	(Notes 5, 12) See MFR_ADC_CONTROL Section for Faster Update Rates		10		Bits
$V_{\text{ICONTROL STP}}$	LSB Step Size Full-Scale Range = 256mV			244		μV
$I_{\text{CONTROL TUE}}$	Total Unadjusted Error	$20\text{mV} \leq V_{\text{IINS}3_C1_SV_{\text{IN}}} \leq 150\text{mV}$ See Block Diagram (Note 10)			± 3	%
t_{CONVERT}	Update Rate	(Note 12)		90		ms

Temperature Readback (TSNS_C0, TSNS_C1)

$T_{\text{RES_T}}$	Resolution			0.25		$^\circ\text{C}$
$T_{\text{0_TUE}}$	External Temperature Total Unadjusted Readback Error	Supporting Only Delta V_{BE} Sensing (Note 13)		3		$^\circ\text{C}$
$T_{\text{1_TUE}}$	Internal TSNS TUE	$V_{\text{RUN_C0,C1}} = 0.0$, $f_{\text{SYNC}} = 0\text{kHz}$ (Note 8)		3		$^\circ\text{C}$
t_{CONVERT}	Update Rate	$\text{MFR_ADC_CONTROL} = 0 \times 04$ or $0 \times 0C$ (Notes 9, 12, 15)		90 8		ms ms

INTV_{CC} Regulator/EXTV_{CC}

V_{INTVCC}	Internal V_{CC} Voltage No Load	$6\text{V} \leq V_{\text{IN}} \leq 16\text{V}$		5.25	5.5	5.75	V
$V_{\text{LDO_INT}}$	INTV _{CC} Load Regulation	$I_{\text{CC}} = 0\text{mA}$ to 20mA , $6\text{V} \leq V_{\text{IN}} \leq 16\text{V}$		0.5	± 2		%
V_{EXTVCC}	EXTV _{CC} Switchover Voltage	$V_{\text{INS}3_C1} \geq 7\text{V}$, EXTV _{CC} Rising		4.5	4.7	4.9	V
$V_{\text{LDO_HYS}}$	EXTV _{CC} Hysteresis			340			mV
$V_{\text{LDO_EXT}}$	EXTV _{CC} Voltage Drop	$I_{\text{CC}} = 20\text{mA}$, $V_{\text{EXTVCC}} = 5.5\text{V}$		60	120		mV
$V_{\text{IN_THR}}$	V_{IN} Threshold to Enable EXTV _{CC} Switchover	V_{IN} Rising		7.1			V
$V_{\text{IN_THF_HYS}}$	V_{IN} Hysteresis to Disable EXTV _{CC} Switchover	V_{IN} Falling		600			mV

ELECTRICAL CHARACTERISTICS The ● denotes the specifications which apply over the specified internal operating temperature range (Note 1, 2, 3). Specified as each individual output channel designated with n (Note 3). $T_A = 25^\circ\text{C}$, $V_{\text{INS}3} = 12\text{V}$, $\text{RUN_C}n = 3.3\text{V}$, $\text{EXTV}_{\text{CC}} = 0\text{V}$, $\text{FREQUENCY_SWITCH} = 350\text{kHz}$ and $V_{\text{OUTC}n}$ commanded to 1.000V unless otherwise noted. Configured with factory default EEPROM settings, unless otherwise noted.

SYMBOL	PARAMETER	CONDITIONS	MIN	TYP	MAX	UNITS
V_{DD33} Regulator						
V _{DD33}	Internal V _{DD33} Voltage	4.5V < V _{INTVCC} or 4.8V < V _{EXTVCC}	3.2	3.3	3.4	V
I _{LIM}	V _{DD33} Current Limit	V _{DD33} = GND, V _{IN} = INTV _{CC} = 4.5V		100		mA
V _{DD33_OV}	V _{DD33} Overvoltage Threshold	(Note 10)		3.5		V
V _{DD33_UV}	V _{DD33} Undervoltage Threshold	(Note 10)		3.1		V
V_{DD25} Regulator						
V _{DD25}	Internal V _{DD25} Voltage			2.5		V
L _{IM}	V _{DD25} Current Limit	V _{DD25} = GND, V _{IN} = INTV _{CC} = 4.5V		80		mA
Oscillator and Phase-Locked Loop						
f _{RANGE}	PLL SYNC Range	Synchronized with Falling Edge of SYNC	●	250	1000	kHz
f _{OSC}	Oscillator Frequency Accuracy	Frequency Switch = 250.0kHz to 1000.0kHz (Note 10)	●		±7.5	%
V _{TH(SYNC)}	SYNC Input Threshold	V _{SYNC} Falling V _{SYNC} Rising		1 1.5		V V
V _{OL(SYNC)}	SYNC Low Output Voltage	I _{LOAD} = 3mA		0.2	0.4	V
I _{LEAK(SYNC)}	SYNC Leakage Current in Slave Mode	0V ≤ V _{PIN} ≤ 3.6V			±5	μA
θ _{SYNC-θ0}	SYNC to Ch0 Phase Relationship Based on the Falling Edge of Sync and Rising Edge of SWC0)	MFR_PWM_CONFIG[2:0] = 0,2,3 MFR_PWM_CONFIG[2:0] = 5 MFR_PWM_CONFIG[2:0] = 1 MFR_PWM_CONFIG[2:0] = 4,6 (Note 10)		0 60 90 120		Deg Deg Deg Deg
θ _{SYNC-θ1}	SYNC to Ch1 Phase Relationship Based on the Falling Edge of Sync and Rising Edge of SWC1	MFR_PWM_CONFIG[2:0] = 3 MFR_PWM_CONFIG[2:0] = 0 MFR_PWM_CONFIG[2:0] = 2,4,5 MFR_PWM_CONFIG[2:0] = 1 MFR_PWM_CONFIG[2:0] = 6 (Note 10)		120 180 240 270 300		Deg Deg Deg Deg Deg
EEPROM Characteristics						
Endurance	(Notes 15, 16)	0°C < T _J < 85°C EEPROM Write Operations	●	10,000		Cycles
Retention	(Notes 15, 16)	T _J < 125°C	●	10		Years
Mass_Write	Mass Write Operation Time	STORE_USER_ALL, 0°C < T _J < 85°C During EEPROM Write Operation	●	440	4100	ms
Input Leakage Current SDA, SCL, ALERT, RUN						
I _{OL}	Input Leakage Current	0V ≤ V _{PIN} ≤ 5.5V	●		±5	μA
Leakage Current FAULT_n, PGOOD_C_n						
I _{LEAK}	Input Leakage Current	0V ≤ V _{PIN} ≤ 3.6V	●		±2	μA
Digital Inputs SCL, SDA, RUN_C_n, FAULT_C_n (Note 10)						
V _{IH}	Input High Threshold Voltage		●		1.35	V
V _{IL}	Input Low Threshold Voltage		●	0.8		V
V _{HYST}	Input Hysteresis	SCL, SDA		0.08		V
C _{PIN}	Input Capacitance				10	pF
Digital Input WP (Note 10)						
I _{PUWP}	Input Pull-Up Current	WP		10		μA
Open-Drain Outputs SCL, SDA, FAULT_C_n, ALERT, RUN_C_n, SHARE_CLK, PGOOD_C_n						
V _{OL}	Output Low Voltage	I _{SINK} = 3mA			0.4	V

ELECTRICAL CHARACTERISTICS The ● denotes the specifications which apply over the specified internal operating temperature range (Note 1, 2, 3). Specified as each individual output channel designated with n (Note 3). $T_A = 25^\circ\text{C}$, $V_{\text{INS}3} = 12\text{V}$, $\text{RUN}_{Cn} = 3.3\text{V}$, $\text{EXTV}_{\text{CC}} = 0\text{V}$, $\text{FREQUENCY_SWITCH} = 350\text{kHz}$ and $V_{\text{OUTC}n}$ commanded to 1.000V unless otherwise noted. Configured with factory default EEPROM settings, unless otherwise noted.

SYMBOL	PARAMETER	CONDITIONS	MIN	TYP	MAX	UNITS
Digital Inputs SHARE_CLK, WP (Note 10)						
V_{IH}	Input High Threshold Voltage	$I_{\text{SINK}} = 3\text{mA}$	●	1.5	1.8	V
V_{IL}	Input Low Threshold Voltage		●	0.6	1	V
Digital Filtering of FAULT$\overline{C}n$ (Note 10)						
T_{FLTf}	Input Digital Filtering $\overline{\text{FAULT}}n$			3		μs
Digital Filtering of PGOOD$_Cn$ (Note 10)						
T_{PGF}	Output Digital Filtering PGOOD $_Cn$			60		μs
Digital Filtering of RUN$_Cn$ (Note 10)						
T_{RUNf}	Input Digital Filtering RUN $_Cn$			10		μs
PMBus Interface Timing Characteristics (Note 10)						
f_{SCL}	Serial Bus Operating Frequency		●	10	400	kHz
t_{BUF}	Bus Free Time Between Stop and Start		●	1.3		μs
$t_{\text{HD(STA)}}$	Hold Time After Repeated Start Condition After This Period, the First Clock is Generated		●	0.6		μs
$t_{\text{SU(STA)}}$	Repeated Start Condition Setup Time		●	0.6	10000	μs
$t_{\text{SU(STO)}}$	Stop Condition Setup Time		●	0.6		μs
$t_{\text{HD(DAT)}}$	Date Hold Time Receiving Data Transmitting Data		● ●	0 0.3	0.9	μs μs
$t_{\text{SU(DAT)}}$	Data Setup Time Receiving Data			0.1		μs
$t_{\text{TIMEOUT_SMB}}$	Stuck PMBus Timer Non-Block Reads Stuck PMBus Timer Block Reads	Measured from the Last PMBus Start Event		3 255		ms ms
t_{LOW}	Serial Clock Low Period		●	1.3	10000	μs
t_{HIGH}	Serial Clock High Period		●	0.6		μs
Channel 0 and Channel 1 Power Stages (Note 10)						
PWM $_Cn$ LOW	PWM Drive Low Level, C0, C1				0.6	V
PWM $_Cn$ HIGH	PWM Drive High Level, C0, C1			2.6		V
PHFLT $_Cn$ T	Warning Temperature			140		C
PHFLT $_Cn$ ACC	Thermal Warning Accuracy			-10	10	Kelvin
PHFLT $_Cn$ HYS	Hysteresis			10		Kelvin
PHFLT $_Cn$ Res	On Resistance	Sink = 8mA		37.5	80	Ω
PHFLT $_Cn$ Leak				0.1	5	μA
PHFLT $_Cn$ Pull-Up	Pull-Up Resistor	Tied to $V_{\text{DD}33}$		10		k Ω

ELECTRICAL CHARACTERISTICS

Note 1. Stresses beyond those listed under Absolute Maximum Ratings may cause permanent damage to the device. Exposure to any Absolute Maximum Rating condition for extended periods may affect device reliability and lifetime. All voltages are referred to GND pin unless otherwise specified.

Note 2. The LTM4664 is tested under pulsed load conditions such that $T_J \approx T_A$. The LTM4664E is guaranteed to meet performance specifications over the 0°C to 125°C internal operating temperature range. Specifications over the full -40°C to 125°C internal operating temperature range are assured by design, characterization and correlation with statistical process controls. The LTM4664I is guaranteed to meet specifications over the full -40°C to 125°C internal operating temperature range. Note that the maximum ambient temperature consistent with these specifications is determined by specific operating conditions in conjunction with board layout, the rated package thermal resistance and other environmental factors.

Note 3. All Currents into the device pins are positive, all currents out of the device are negative. Each channel of PSM is tested independently in production. A shorthand notation is used in this document that allows these parameters to be referred to by “ V_{INS3_Cn} ” and “ V_{OUTCn} ”, where n is permitted to take on a value of 0 or 1. This italicized “ n ” notation and convention is extended to encompass all such pin names, as well as register names with channel-specific, i.e., paged data. For example, $V_{OUT_COMMANDn}$ refers to the $V_{OUT_COMMAND}$ command code data located in Pages 0 and 1, which in turn relate to channel 0 (V_{OUTC0}) and channel 1 (V_{OUTC1}). Registers containing non-page-specific data, i.e., whose data is “global” to the module or applies to both of the module’s channels lack the italicized, “ n ”, e.g., $FREQUENCY_SWITCH$.

Note 4. See output current derating curves for different V_{IN} , V_{OUT} , Load Current and T_A , located in the Dual 25A PSM Applications Information section.

Note 5. The data format in PMBus is 5 bits exponent (signed) and 11 bits mantissa (signed). This limits the output resolution to 10 bits though the internal ADC is 16 bits and the calculations use 32-bit words.

Note 6. V_{OUTCn} (DC) and line and load regulation tests are performed in production with digital servo disengaged ($MFR_PWM_MODEn[6] = 0b$) and low V_{OUTCn} range selected $MFR_PWM_MODEn[1] = 1b$. The digital servo control loop is exercised in production (setting $MFR_PWM_MODEn[6] = 1b$), but convergence of the output voltage to its final settling value is not necessarily observed in final test—due to potentially long time constants involved—and is instead guaranteed by the output voltage

readback accuracy specification. Evaluation in application demonstrates capability; see the Typical Performance Characteristics section.

Note 7. These typical parameters are based on bench measurements and are not production tested.

Note 8. Even though V_{OUTC0} and V_{OUTC1} are specified for 3.6V absolute maximum, the maximum recommended command voltage to regulate output channels 0 and 1 is 1.5V with V_{OUT} range-setting bit set using $MFR_PWM_MODEn[1]$.

Note 9. Channel n OV/UV comparator threshold accuracy for $MFR_PWM_MODEn[1] = 1b$ tested in ATE at $V_{VOSNS^+Cn} - V_{VOSNS^-Cn} = 0.5V$ and 2.7V. $MFR_PWM_MODEn[1] = 1b$ is the Low Range.

Note 10. Tested at IC-level ATE

Note 11. The absolute maximum rating for the V_{INS3} pin is 18V. Input voltage telemetry ($READ_VIN$) is obtained by digitizing a voltage scaled down from the V_{INS3} pin.

Note 12. The data conversion is done by default in round robin fashion. All inputs signals are continuously converted for a typical latency of 90ms. Setting MFR_ADC_CONTRL value to be 0 to 12, LTM4664 can do fast data conversion with only 8ms to 10ms. See section PMBus Command for details.

Note 13. Part tested with PWM disabled. Evaluation in application demonstrates capability. $TUE(\%) = ADC\ Gain\ Error(\%) + 100 \cdot (Zero\ code\ Offset + ADC\ Linearity\ Error)/Actual\ Value$.

Note 14. EEPROM endurance and retention are guaranteed by wafer-level testing for data retention. The minimum retention specification applies for devices whose EEPROM has been cycled less than the minimum endurance specification, and whose EEPROM data was written to at 0°C $\leq T_J \leq 85^\circ C$. The $RESTORE_USER_ALL$ or MFR_RESET is valid over the entire operating temperature range and does not influence EEPROM characteristics.

Note 15. Write operations above $T_J = 85^\circ C$ or below 0°C are possible although the Electrical Characteristics are not guaranteed and the EEPROM will be degraded. Read operations performed at temperatures below 125°C will not degrade the EEPROM Writing to the EEPROM above 85°C will result in a degradation of retention characteristics.

Note 16. M1-M8 power MOSFET are final tested separately before assembly in to the μ Module.

Note 17: $MFR_PWM_MODE[2] = 1$ or 0 sets device in low DCR mode or regular DCR mode respectively. $MFR_PWM_MODE[7]=1$ or 0 sets device in high output current range or low current range. See “Output Current Sensing and sub milliohm DCR Current Sensing” in Operation Section for details. Only V_{LIMIT} codes 2–8 are supported for DCR sensing.

TYPICAL PERFORMANCE CHARACTERISTICS

0.9V Individual Single Output
 1st Stage = 100kHz,
 2nd Stage = 200kHz,
 Final 25A Stages = 250kHz,
 EXT_{V_{CC}} = 5V

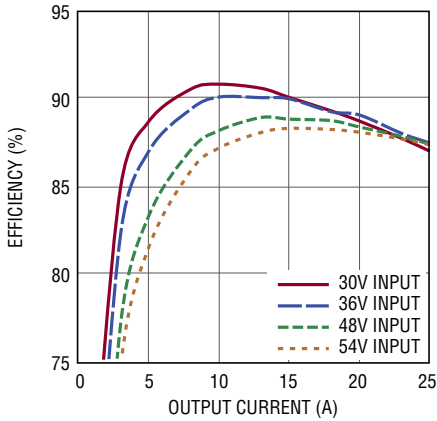

4664 G01

1V Individual Single Output
 1st Stage = 100kHz,
 2nd Stage = 200kHz,
 Final 25A Stages = 250kHz,
 EXT_{V_{CC}} = 5V

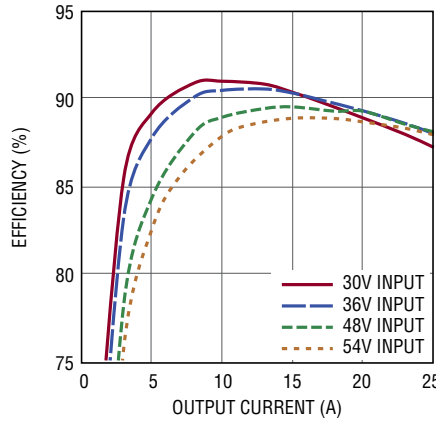

4664 G02

1.2V Individual Single Output
 1st Stage = 100kHz,
 2nd Stage = 200kHz,
 Final 25A Stages = 250kHz,
 EXT_{V_{CC}} = 5V

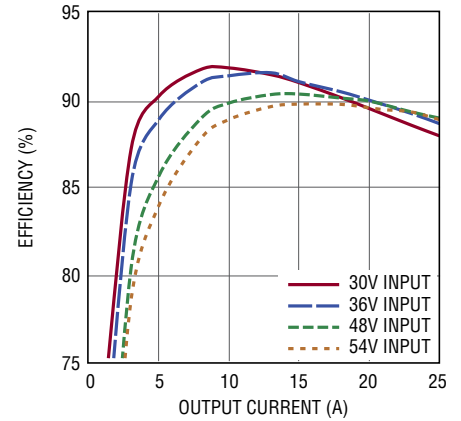

4664 G03

1.5V Individual Single Output
 1st Stage = 100kHz,
 2nd Stage = 200kHz,
 Final 25A Stages = 350kHz,
 EXT_{V_{CC}} = 5V

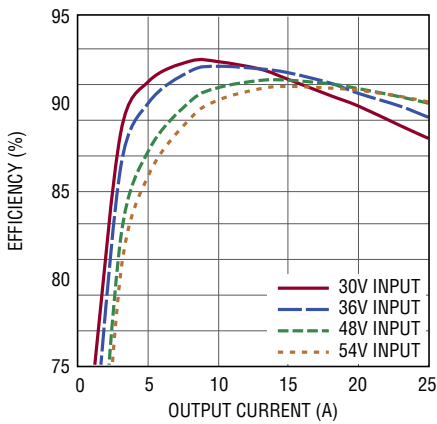

4664 G04

54V Input, 2-Phase 50A Single Output
 1st Stage = 100kHz,
 2nd Stage = 200kHz,
 Final 25A Stages = 350kHz,
 EXT_{V_{CC}} = 5V

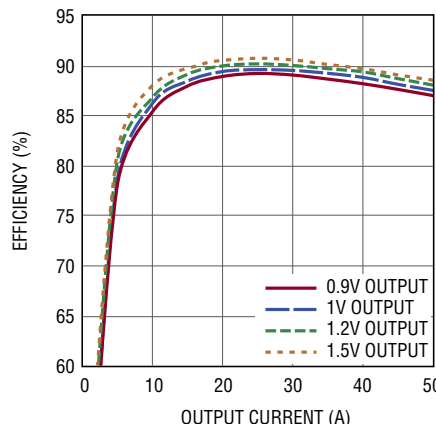

4664 G05

54V Input Voltage Change, No Load

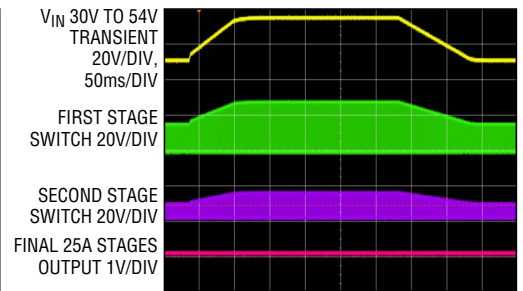

4664 G06

54V TO 1V, NO LOAD
 4:1 DIVIDER: FIRST STAGE 100kHz,
 SECOND STAGE 200kHz,
 FINAL 25A STAGES 250kHz

54V Input Voltage Change, Load 25A Each

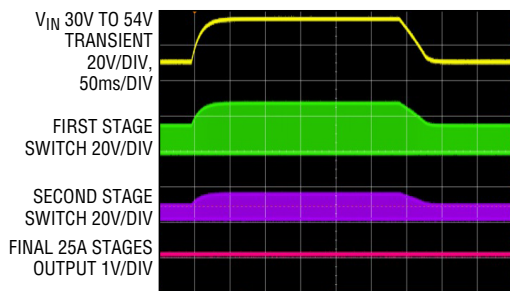

4664 G07

54V TO 1V, 25A LOAD EACH
 4:1 DIVIDER: FIRST STAGE 100kHz,
 SECOND STAGE 200kHz,
 FINAL 25A STAGES 250kHz

Dual Output Tracking Start-Up/Shutdown

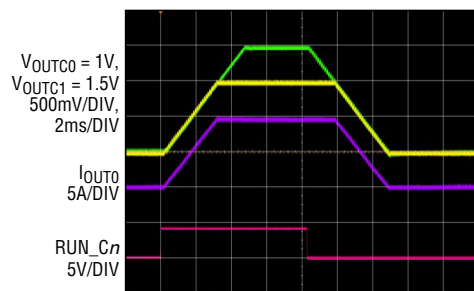

4664 G08

48V_{IN}, 10A LOAD ON V_{OUT0}, NO LOAD ON V_{OUT1},
 TON_RISE 0 = 3ms, TON_RISE 1 = 4.5ms,
 TOFF_DELAY 1 = 0ms, TOFF_DELAY 0 = 1.5ms
 TOFF_FALL 1 = 4.5ms, TOFF_FALL 0 = 3ms,
 ON_OFF_CONFIG_n = 0x1E

TYPICAL PERFORMANCE CHARACTERISTICS

Dual Output Start-Up/Shutdown with a Prebiased Load

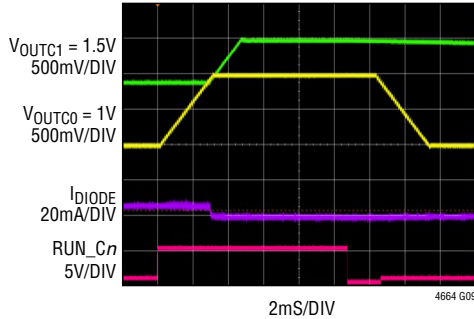

48VIN, 10A LOAD ON VOUT0, 7.5mA LOAD ON VOUT1, VOUT1 PREBIASED THROUGH A DIODE
 TON_RISE 0 = 3ms, TON_RISE 1 = 4.5ms,
 TOFF_DELAY 1 = 0ms, TOFF_DELAY 0 = 1.5ms
 TOFF_FALL 1 = 4.5ms, TOFF_FALL 0 = 3ms,
 ON_OFF_CONFIGn = 0x1E

Start-Up

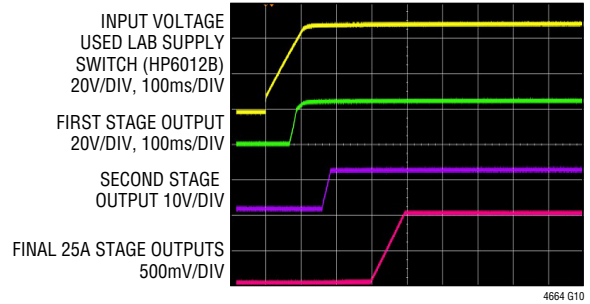

48V TO 1V AT 0A LOAD, EACH 25A STAGE
 FINAL STAGE TON DELAY AND TON RISE SET
 TO 100ms

Shutdown

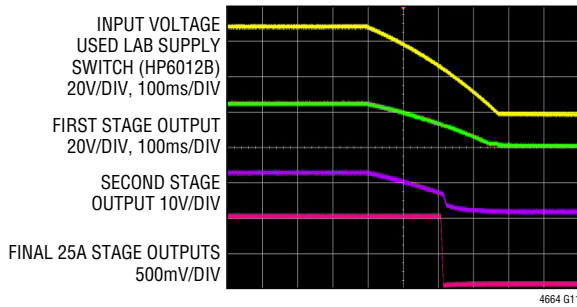

48V TO 1V AT 0A LOAD, EACH 25A STAGE
 FINAL STAGE TON DELAY AND TON RISE SET
 TO 100ms

Full Sequence Turn On

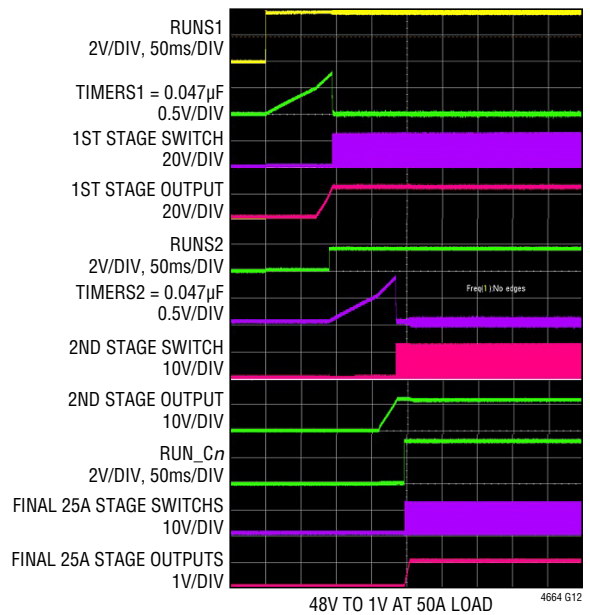

48V TO 1V AT 50A LOAD

Full Sequence Turn Off

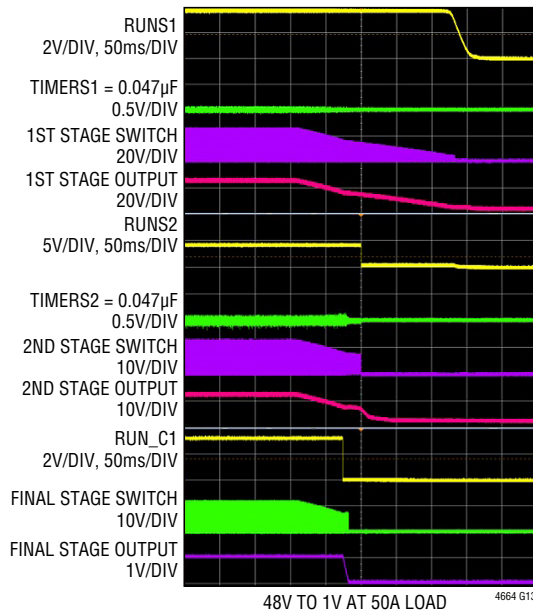

48V TO 1V AT 50A LOAD

TYPICAL PERFORMANCE CHARACTERISTICS

V_{OUTCn} (1V) Load Transient

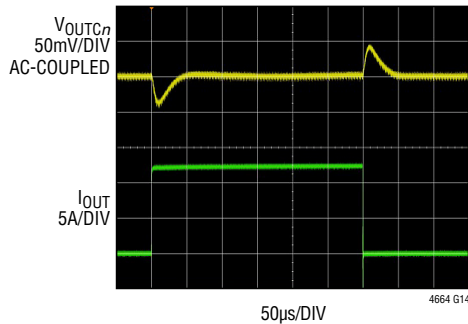

48V TO 1V SINGLE CHANNEL,
0A TO 12.5A/μs LOAD STEP
 $C_{OUT} = 470\mu\text{F} \times 2$ POSCAP, $100\mu\text{F} \times 5$ CER,
 $COMP_Cna = 2200\text{pF}$, $COMP_Cnb = 100\text{pF}$,
EA-GM = 3.69ms, RCOMP = 5k,
PSM FREQ = 250kHz, I_{LIMIT} RANGE = LOW
 V_{OUT} RANGE = LOW

V_{OUTCn} (1.5V) Load Transient

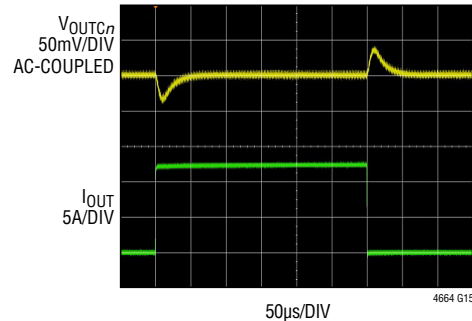

48V TO 1.5V SINGLE CHANNEL, 0A TO 12.5A/μs
LOAD STEP
 $C_{OUT} = 470\mu\text{F} \times 1$ POSCAP, $330\mu\text{F} \times 2$ CER,
 $COMP_Cra = 2200\text{pF}$, $COMP_Crb = 220\text{pF}$,
EA-GM = 3.02ms, RCOMP = 6k,
PSM FREQ = 350kHz

Dual Phase (50A/0.9V) Load Transient

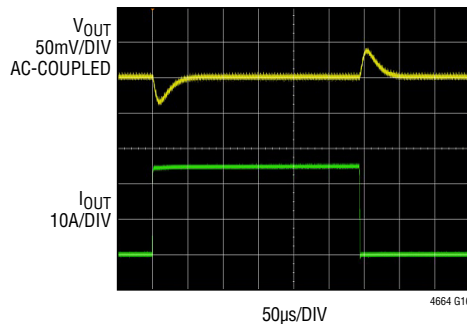

48V TO 0.9V DUAL PHASE SINGLE OUTPUT, 0A
TO 25A/μs LOAD STEP
 $C_{OUT} = 470\mu\text{F} \times 2$ POSCAP, $330\mu\text{F} \times 5$ CER,
 $COMP_C0_1 = 1500\text{pF}$, $COMP_C01b = 100\text{pF}$,
EA-GM = 4.36ms, RCOMP = 13k,
PSM FREQ = 250kHz, I_{LIMIT} RANGE = LOW
 V_{OUT} RANGE = LOW

Dual Phase (50A/1V) Load Transient

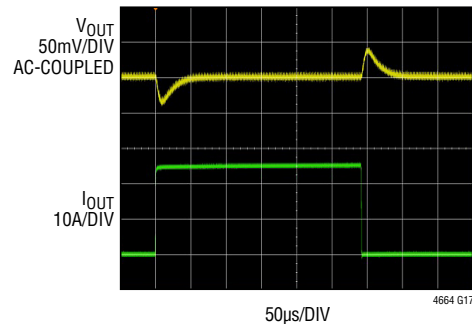

48V TO 1V DUAL PHASE SINGLE OUTPUT, 0A TO
25A/μs LOAD STEP
 $C_{OUT} = 470\mu\text{F} \times 2$ POSCAP, $5 \times 330\mu\text{F}$ CER,
 $COMP_C0_1 = 1500\text{pF}$, $COMP_C01b = 100\text{pF}$,
EA-GM = 4.36ms, RCOMP = 13k,
PSM FREQ = 350kHz, I_{LIMIT} RANGE = LOW
 V_{OUT} RANGE = LOW

25A AC Ripple Noise

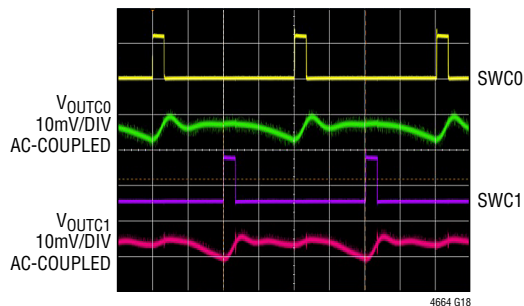

48V TO $V_{OUTC0} = 1\text{V}$, AND $V_{OUTC1} = 1\text{V}$

TYPICAL PERFORMANCE CHARACTERISTICS

48V to 1V, Second Stage (12V) Shorted

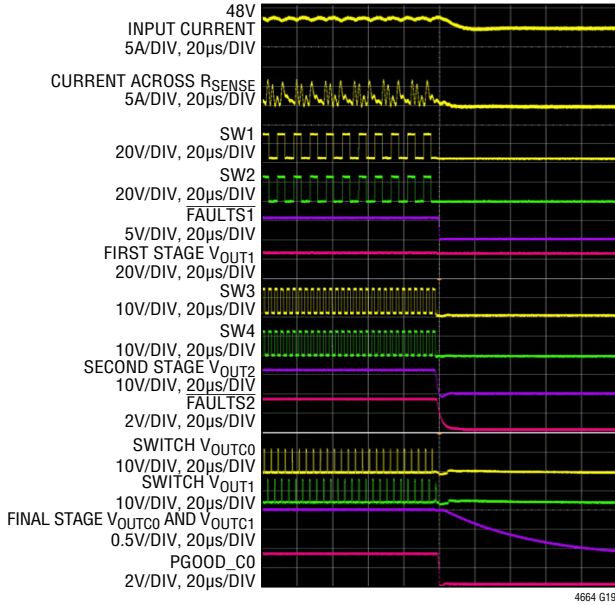

48V TO 1V AT 50A V_{OUT2} STAGE 12V OUTPUT SHORTED

48V to 1V at 50A Shorted

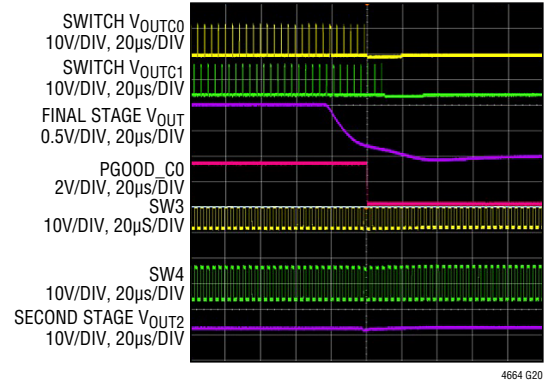

48V TO 1V AT 50A SHORTED LAST STAGE 1V OUTPUT V_{OUTC0} AND V_{OUTC1} IN PARALLEL

READ_IOUT of 16 LTM4664 Channels $12V_{IN}$, $1V_{OUT}$, $T_J = -40^\circ\text{C}$, $I_{OUTn} = 25\text{A}$, System Having Reached Thermally Steady-State Condition, No Airflow

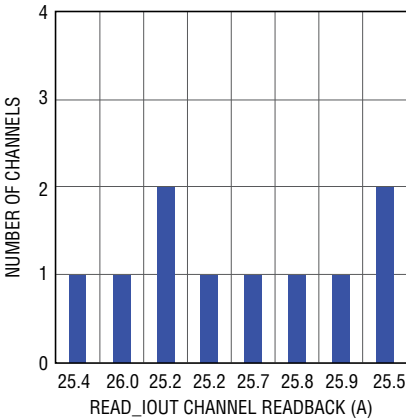

READ_IOUT of 16 LTM4664 Channels $12V_{IN}$, $1V_{OUT}$, $T_J = 25^\circ\text{C}$, $I_{OUTn} = 25\text{A}$, System Having Reached Thermally Steady-State Condition, No Airflow

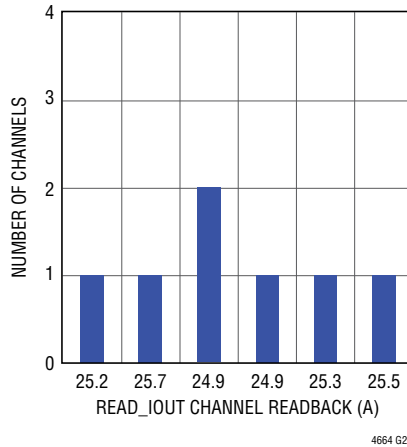

READ_IOUT of 16 LTM4664 Channels $12V_{IN}$, $1V_{OUT}$, $T_J = 125^\circ\text{C}$, $I_{OUTn} = 25\text{A}$, System Having Reached Thermally Steady-State Condition, No Airflow

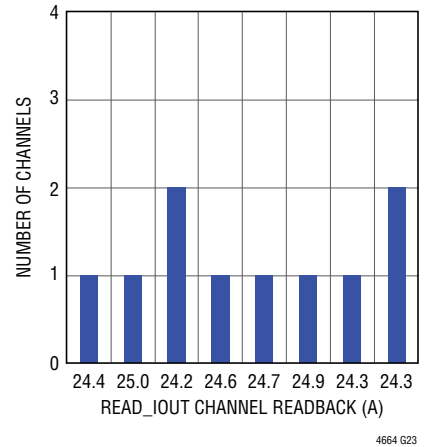

PIN FUNCTIONS

4:1 Divider Section (Stage 1)

V_{INS1}: (J15-J16) Power input pins to the first stage divide by two. Place input capacitance between these pins and GND.

INSNSS1⁺: (J14) Current sense comparator positive input, connected to the positive node of the external current sensing resistor. The current sensing resistor has to be placed on the drain of the very top MOSFET. When the voltage between INSNSS1⁺ pin and INSNSS1⁻ pin is higher than 50mV, the Stage 1 controller indicates an overcurrent fault by pulling the $\overline{\text{FAULTS1}}$ pin down. The INSNSS1⁺ pin is also used to source 95mA current to the V_{OUT1} pin during the pre-balance time in divider applications. Connect directly to the drain of the very top MOSFET if not used. See application schematic section.

INSNSS1⁻: (J13) Current sense comparator negative input, connected to the negative node of the current sensing resistor. Short to INSNSS1⁺ if not used.

V_{OUT1}: (C14-C16) 1st stage divide by two output pins. These pins connect to the 2nd stage V_{INS2} pins. Recommend placing output decoupling capacitance directly between these pins and GND pins.

GND: (A8-A9, B1-B3, B8-B9, B14-B16, C4-C13, D4,D8,D9, D13, E1-E4, E8-E9, E13-E16, F1-F4, F8-F10, G4, G8-G11, H4, H9-H11, J1-J4, J11, K1-K4, K11, L3, L11, L14-L16, M3-M5, M11, M14, N1-N4, N7, N11-N16, P1-P4, P7-P9, P13-P15, R1-R6, R9, R13-16, T2-T3, T8-T9, T14-T15) Main ground pins for all ground returns. Input and output capacitors are connected to these pin. See recommended layout Figure 45.

SW1, SW2: (G14-G16), (D14-D16) Switching nodes for the 1st stage C_{FLY} Flying capacitor. See Block Diagram.

RUNS1: (F11) Stage 1 Run Control Input. Forcing RUNS1 below 1.2V shuts down the controller. When RUNS1 is higher than 1.2V, internal circuitry starts up. There is a 1 μ A pull-up current flowing out of RUNS1 pin when the RUNS1 pin voltage is below 1.2V and an additional 5 μ A current flowing out of RUNS1 pin when the RUNS1 pin voltage is above 1.2V.

$\overline{\text{FAULTS1}}$: (E11) This is an open drain output pin. $\overline{\text{FAULTS1}}$ is pulled to ground when the V_{OUT1} voltage is out of the (V_{INS1})/2 window threshold or the voltage between INSNSS1⁺ and INSNSS1⁻ is higher than 50mV. $\overline{\text{FAULTS1}}$ pin is released after INTV_{CCS1} starts up and passes UVLO. Use $\overline{\text{FAULTS1}}$ or PGOODS1 to sequence on RUNS2 for the second stage.

PGOODS1: (D12) This is an open drain output pin. PGOODS1 is pulled to ground if there are any faults or the voltage at UVS1 pin is lower than 1V. Use PGOODS1 or $\overline{\text{FAULTS1}}$ to sequence on RUNS2 for the second stage.

UVS1: (E10) Undervoltage Comparator. If the UVS1 pin voltage is lower than 1V, the PGOODS1 pin is pulled down. If the UV pin voltage is higher than 1V and no faults, PGOODS1 pin is released. Connect to INTV_{CCS1} if not used. This pin is used to validate proper output regulation.

HYS_PRGMS1: (G12) A resistor connected between this pin and ground will set the window threshold of the window comparator that monitors the voltage difference between (V_{INS1})/2 and V_{OUT1}. There is a 10 μ A current flowing out of this pin. See Applications section.

TIMERS1: (F12) Charge Balance and Fault Timer Control Input. A capacitor between this pin and ground sets the amount of time to charge V_{OUT1} to (V_{INS1})/2. It also sets the short-circuit retry time. See the 4:1 Divider Application Information.

FREQS1: (E12) Frequency Set Pin. There is a precision 10 μ A current flowing out of this pin. A resistor to ground sets a voltage which in turn programs the frequency. See the 4:1 Divider Application Information section for detailed information.

INTV_{CCS1}: (D10) Output of the 5.5V internal linear low dropout regulator. The driver and control circuits are powered from this voltage source. Must be bypassed to power ground with a minimum of 4.7 μ F ceramic or other low ESR capacitor. Do not use the INTV_{CCS1} pin for any other ICs.

PIN FUNCTIONS

EXTV_{CCS1}: (D11) External Power Input to the Internal LDO Connected to INTV_{CCS1}. This LDO supplies INTV_{CCS1} power, bypassing the internal LDO powered from V_{INS1} whenever EXTV_{CCS1} is higher than 6.5V and V_{INS1} is higher than 7V. Do not exceed 30V on this pin. This pin can be driven with the V_{OUT2} output to limit power loss in LDO with V_{INS1} at higher input voltage. See Applications section.

4:1 Divider Section (Stage 2)

V_{INS2}: (C1-C3) Power input pins to the second stage divide by two. Place input capacitance between these pin and GND.

V_{INS2F}: (D5) Input Voltage Sensing with Filtering. This pin has a 1k Ω resistor in series from V_{INS2}, and a 4700pf capacitor to GND. The pin has a 1M Ω resistance to GND. See Block Diagram.

INSNSS2⁺: (D7) Current sense comparator positive input, connected to the positive node of the external current sensing resistor. The current sensing resistor has to be placed on the drain of the very top MOSFET. When the voltage between INSNSS2⁺ pin and INSNSS2⁻ pin is higher than 50mV, the controller indicates an overcurrent fault by pulling the FAULTS2 pin down. The INSNSS2⁺ pin is also used to source 95mA current to the V_{OUT2} pin during the pre-balance time in divider applications. Connect directly to the drain of the very top MOSFET if not used. See Application Schematic section.

INSNSS2⁻: (D6) Current sense comparator negative input, connected to the negative node of the current sensing resistor. Short to INSNSS2⁺ if not used.

V_{OUT2}: (H1-H3) 2nd stage divide by two output pins. These pins connect to the V_{INS3} input of dual 25A PMBus converter. Recommend placing output decoupling capacitance directly between these pins and GND pins.

SW3, SW4: (D1-D3), (G1-G3) Switching nodes for the 2nd stage C_{FLY} Flying capacitor. See Block Diagram.

RUNS2: (G6) Stage 2 Run Control Input. Forcing RUNS2 below 1.2V shuts down the controller. When RUNS2 is higher than 1.2V, internal circuitry starts up. There is a 1 μ A pull-up current flowing out of RUNS2 pin when the

RUNS2 pin voltage is below 1.2V and an additional 5 μ A current flowing out of RUNS2 pin when the RUNS2 pin voltage is above 1.2V. Use PGOODS1, and FAULTS1 from stage one to enable stage 2.

FAULTS2: (H6) This is an Open Drain Output Pin. FAULTS2 is pulled to ground when the V_{OUT2} voltage is out of the (V_{INS2})/2 window threshold or the voltage between INSNSS2⁺ and INSNSS2⁻ is higher than 50mV. FAULTS2 pin is released after INTV_{CCS2} starts up and passes UVLO. Use FAULTS2 or PGOOD2 to sequence on RUN_C0, and RUN_C1 for the dual 25A PSM stage.

PGOODS2: (H5) This is an Open Drain Output Pin. PGOODS2 is pulled to ground if there are any faults or the voltage at UVS2 pin is lower than 1V. Use PGOOD2 or FAULTS2 to sequence on RUN_C0, and RUN_C1 for the dual 25A stage.

UVS2: (H7) Undervoltage Comparator. If the UVS2 pin voltage is lower than 1V, the PGOODS2 pin is pulled down. If the UV pin voltage is higher than 1V and no faults, PGOODS2 pin is released. Connect to INTV_{CCS2} if not used. This pin is used to validate proper output regulation.

HYS_PRGMS2: (E5) A resistor connected between this pin and ground will set the window threshold of the window comparator that monitors the voltage difference between (V_{INS2})/2 and V_{OUT2}. There is a 10 μ A current flowing out of this pin. See applications section.

TIMERS2: (F5) Charge Balance and Fault Timer Control Input. A capacitor between this pin and ground sets the amount of time to charge V_{OUT2} to (V_{INS2})/2. It also sets the short-circuit retry time. See the 4:1 Divider Application Information.

FREQS2: (G5) Frequency Set Pin. There is a precision 10 μ A current flowing out of this pin. A resistor to ground sets a voltage which in turn programs the frequency. See the 4:1 Divider Application Information section for detailed information.

INTV_{CCS2}: (G7) Output of the 5.5V internal linear low dropout regulator. The driver and control circuits are powered from this voltage source. Must be bypassed to

PIN FUNCTIONS

power ground with a minimum of 4.7 μ F ceramic or other low ESR capacitor. Do not use the INTV_{CCS2} pin for any other ICs.

EXTV_{CCS2}: (F7) External Power Input to the Internal LDO Connected to INTV_{CCS2}. This LDO supplies INTV_{CCS2} power, bypassing the internal LDO powered from V_{IN2} whenever EXTV_{CCS2} is higher than 6.5V and V_{INS2} is higher than 7V. Do not exceed 30V on this pin. This pin can be driven with the V_{OUT2} output to limit power loss in LDO with V_{INS2} at higher input voltage. See 4:1 Divider Application Information section.

V_{OUT2}_SET: (F6) External – comparator input for setting the V_{OUT2} trip reference level. This can be done with a resistor and 5.1V Zener from V_{IN}. This secondary fault protection is in and above the Fault protection for Stage 1 and Stage 2. The overall input voltage is divided down by four, so V_{OUT2} will be 1/4 of V_{IN}. The OVP_SET pin will have a voltage divider to monitor the V_{OUT2} voltage and set to trip when the divider midpoint on the OVP_SET pin exceeds the reference trip level. If not used, tie this pin to ground. See 4:1 Divider Application Information section.

OVP_SET: (E6) External + input for setting the V_{OUT2} trip level. The OVP_SET pin will have a voltage divider to monitor the V_{OUT2} voltage and set to trip when the divider midpoint on the OVP_SET pin exceeds the reference trip level on the V_{OUT2}_SET pin. For example, if the OVP_SET trip point was set for V_{TRIP}, then $R_{TOP} = ((V_{TRIP}/5.1V) - 1) \cdot 7.5k$, with R_{TOP} being the top resistor in the divider, and R_{BOT} is the bottom resistor in the divider. R_{BOT} set to 7.5k. If not used, tie this pin to INTV_{CCS2}. See 4:1 Divider Application Information section.

OVP_TRIP: (E7) Open collector output that is used to trip off input power and clamp hold up energy during an over voltage fault on V_{OUT2}. See Applications section.

PMBus Dual 25A Section

V_{INS3_C1}, V_{INS3_C0}: (L1-L2, M1-M2), (L12-L13, M12-M13): Main power input to channel 0, and channel 1 power stages. Provide sufficient decoupling capacitance in the form of multilayer ceramic capacitors (MLCCs) and low ESR electrolytic (or equivalent) to handle reflected input current ripple from the step-down switching stages.

MLCCs should be placed as close to the V_{INS3} as physically possible. The V_{INS3_C1} input provides the input power for the INTV_{CC} LDO regulator. See Layout Recommendations in the Dual 25A PSM Applications Information section.

V_{OUTC0}: (A10-A16, B10-B13): Channel 0 Output Voltage. Place recommended output capacitors from this connection to GND. See recommended layout in Figure 45.

V_{OSNS+}_C0: (R12) Channel 0 Positive Differential Voltage Sense Input. Together, V_{OSNS+}_C0 and V_{OSNS-}_C0 serve to kelvin-sense the V_{OUTC0} output voltage at V_{OUTC0}'s point of load (POL) and provide the differential feedback signal directly to Channel 0's feedback loop. Command V_{OUTC0}'s target regulation voltage by serial bus. Its initial command value at V_{INS3} power-up is dictated by NVM (non-volatile memory) contents (factory default: 1.000V)—or, optionally, may be set by configuration resistors; see V_{OUTC0}_CFG and the 4:1 Divider Application Information section.

V_{OSNS-}_C0: (P12): Channel 0 Negative Differential Voltage Sense Input. See V_{OSNS+}_C0.

V_{OUTC1} (A1-A7, B4-B7): Channel 1 Output Voltage. Place recommended output capacitors from this connection to GND. See recommended layout in Figure 45.

V_{OSNS+}_C1 (P6): Channel 1 Positive Differential Voltage Sense Input. Together, V_{OSNS+}_C1 and V_{OSNS-}_C1 serve to kelvin sense the V_{OUTC1} output voltage at V_{OUTC1}'s point of load (POL) and provide the differential feedback signal directly to Channel 1's feedback loop. Command V_{OUTC1}'s target regulation voltage by serial bus. Its initial command value at V_{INS3} power-up is dictated by NVM (non-volatile memory) contents (factory default: 1.000V)—or, optionally, may be set by configuration resistors; see V_{OUTC1}_CFG and the 4:1 Divider Application Information section.

V_{OSNS-}_C1 (N6): Channel 1 Negative Differential. Voltage Sense Input. See V_{OSNS+}_C1.

IN⁺ (R10): Positive Current Sense Amplifier Input. If the input current sense amplifier is not used, this pin must be shorted to the IN⁻ and V_{INS3} pins. See 4:1 Divider Application Information section for detail about the input current sensing.

PIN FUNCTIONS

IN⁻ (P10): Negative Current Sense Amplifier Input. If the input current sense amplifier is not used, this pin must be shorted to the IN⁺ and V_{IN3} pins. See 4:1 Divider Application Information section for detail about the input current sensing.

SGND_CO_C1 (M9, N8-N9): SGND_CO_C1 is the signal ground return path of the Dual 25A control. SGND_CO_C1 is not internally connected to GND. Connect SGND_CO_C1 to GND at the A9, B9, and C9 pins that is close to the output capacitor ground connections. See recommended layout.

SWC0, SWC1 (T10-T13), (T4-T7): Switching Node of Channel 0 and Channel 1. Used for test purposes or EMI snubbing.

EXTV_{CC} (R8): External Power Input to an Internal Switch Connected to INTV_{CC}. This switch closes and supplies the IC power, bypassing the internal regulator whenever EXTV_{CC} is higher than 4.7V and V_{IN} is higher than 7V. EXTV_{CC} also powers up V_{DD33} when EXTV_{CC} is higher than 4.7V and INTV_{CC} is lower than 3.8V. Do not exceed 6V on this pin. Decouple this pin to PGND with a minimum of 4.7μF low ESR tantalum or ceramic capacitor. If the EXTV_{CC} pin is not used to power INTV_{CC}, the EXTV_{CC} pin must be tied GND. Its recommended to use this pin if a bias is available to reduce power loss.

INTV_{CC} (R7): Internal Regulator, 5.5V output. When operating the V_{INS3} from 7V ≤ V_{INS3} ≤ 16V, a LDO generates INTV_{CC} from V_{INS3_C1} to bias internal control circuits and the MOSFET drivers of the dual 25A power supply. An external 2.2μF ceramic decoupling is required. INTV_{CC} is regulated regardless of the RUN_Cn pin state.

V_{DD33} (L6): Internally Generated 3.3V Power Supply Output Pin. This pin should only be used to provide external current for the pull-up resistors required for $\overline{\text{FAULT}}_{Cn}$, SHARE_CLK, and SYNC, and may be used to provide external current for pull-up resistors on RUN_Cn, SDA, SCL, $\overline{\text{ALERT}}$ and PGOOD_Cn. No external decoupling is required.

V_{DD25} (K6): Internally Generated 2.5V Power Supply Output Pin. Do not load this pin with external current; it is used strictly to bias internal logic and provides current for the internal pull-up resistors connected to the configuration-programming pins. No external decoupling is required.

ASEL (J8): Serial Bus Address Configuration Pin. On any given I²C/SMBus serial bus segment, every device must have its own unique slave address. If this pin is left open, the LTM4664 powers up to its default slave address of 0x4F (hexadecimal), i.e., 1001111b (industry standard convention is used throughout this document: 7-bit slave addressing). The lower four bits of the LTM4664's slave address can be altered from this default value by connecting a resistor from this pin to SGND. Minimize capacitance—especially when the pin is left open—to assure accurate detection of the pin state. See 4:1 Divider Application Information section.

FSWPH_CFG (H8): Switching Frequency, Channel Phase Interleaving Angle and Phase Relationship to SYNC Configuration Pin. If this pin is left open—or, if the dual 25A regulator is configured to ignore pin-strap (RCONFIG) resistors, i.e., MFR_CONFIG_ALL[6] = 1b—then the LTM4664's switching frequency (FREQUENCY_SWITCH) and channel phase relationships (with respect to the SYNC clock; MFR_PWM_CONFIG[2:0]) are dictated at SV_{IN} power-up according to the LTM4664's NVM contents. Default factory values are: 350kHz operation; Channel 0 at 0°; and Channel 1 at 180° (convention throughout this document: a phase angle of 0° means the channel's switch node rises coincident with the falling edge of the SYNC pulse). Connecting a resistor divider from V_{DD25} to SGND_CO_C1, see page 4 (and using the factory default NVM setting of MFR_CONFIG_ALL[6] = 0b) allows a convenient way to configure multiple LTM4664s with identical NVM contents for different switching frequencies of operation and phase interleaving angle settings of intra- and extra-module-paralleled channels—all, without GUI intervention or the need to “custom preprogram” module NVM contents. (See the Dual 25A PSM Applications Information section.) Minimize capacitance—especially when the pin is left open—to assure accurate detection of the pin state.

VOUTCO_CFG (J6): Output Voltage Select Pin for V_{OUTCO}, Coarse Setting. If the VOUTCO_CFG and VTRIMCO_CFG pins are both left open—or, if the LTM4664 is configured to ignore pin-strap (RCONFIG) resistors, i.e., MFR_CONFIG_ALL[6] = 1b—then the LTM4664s target V_{OUTCO} output voltage setting (VOUT_COMMANDON)

PIN FUNCTIONS

and associated power good and OV/UV warning and fault thresholds are dictated at SV_{IN} power-up according to the LTM4664's NVM contents. A resistor connected from this pin to SGND—in combination with resistor pin settings on VTRIMC0_CFG, and using the factory-default NVM setting of MFR_CONFIG_ALL[6] = 0b—can be used to configure the LTM4664's Channel 0 output to power-up to a VOUT_COMMAND value (and associated output voltage monitoring and protection/fault-detection thresholds) different from those of NVM contents. (See the 4:1 Divider Application Information section.) Minimize capacitance especially when the pin is left open to assure accurate detection of the pin state. Note that use of RCONFIGs on VOUTC0_CFG/VTRIMC0_CFG can affect the V_{OUTC0} range setting (MFR_PWM_MODE0 [1]) and loop gain.

VTRIMC0_CFG (K5): Output Voltage Select Pin for V_{OUTC0} , Fine Setting. Works in combination with VOUTC0_CFG to affect the VOUT_COMMAND (and associated output voltage monitoring and protection/fault-detection thresholds) of Channel 0, at SV_{IN} power-up. (See VOUTC0_CFG and the Dual 25A PSM Applications Information section.) Minimize capacitance especially when the pin is left open to assure accurate detection of the pin state. Note that use of RCONFIGs on VOUTC0_CFG/VTRIMC0_CFG can affect the V_{OUTC0} range setting (MFR_PWM_MODE0 [1]) and loop gain.

VOUTC1_CFG (J7): Output Voltage Select Pin for V_{OUTC1} , Coarse Setting. If the VOUTC1_CFG and VTRIMC1_CFG pins are both left open or, if the LTM4664 is configured to ignore pin-strap (RCONFIG) resistors, i.e., MFR_CONFIG_ALL [6] = 1b then the LTM4664's target V_{OUTC1} output voltage setting (VOUT_COMMAND1) and associated OV/UV warning and fault thresholds are dictated at SV_{IN} power up according to the LTM4664's NVM contents, in precisely the same fashion that the VOUTC1_CFG and VTRIMC1_CFG pins affect the respective settings of V_{OUT1} /Channel 1. (See VOUTC1_CFG, VTRIMC1_CFG and the 4:1 Divider Application Information section.) Minimize capacitance—especially when the pin is left open—to assure accurate detection of the pin state. Note that use of RCONFIGs on VOUTC1_CFG/VTRIMC1_CFG can affect the V_{OUTC1} range setting (MFR_PWM_MODE1 [1]) and

loop gain. A resistor divider from V_{DD25} to SGND_C0_C1. See page 43.

VTRIMC1_CFG (J5): Output Voltage Select Pin for V_{OUTC1} , Fine Setting. Works in combination with VOUTC1_CFG to affect the VOUT_COMMAND (and associated output voltage monitoring and protection/fault-detection thresholds) of Channel 1, at SV_{IN} power-up. (See VOUTC1_CFG and the Dual 25A PSM Applications Information section.) Minimize capacitance—especially when the pin is left open—to assure accurate detection of the pin state. Note that use of RCONFIGs on VOUTC1_CFG/VTRIMC1_CFG can affect the V_{OUTC1} range setting (MFR_PWM_MODE1 [1]) and loop gain. A resistor divider from V_{DD25} to SGND_C0_C1 can set the trim value, see page 43.

RUN_C0, RUN_C1 (J9, K8 Respectively): Enable Run Input for Channels 0 and 1, respectively. Open-drain input and output. Logic high on these pins enables the respective outputs of the LTM4664. These open-drain output pins hold the pin low until the LTM4664 is out of reset and V_{IN3_C1} is detected to exceed V_{IN_ON} . A pull-up resistor to 3.3V is required in the application. The LTM4664 pulls RUN_C0 and/or RUN_C1 low, as appropriate, when a global fault and/or channel-specific fault occurs whose fault response is configured to latch off and cease regulation; issuing a CLEAR_FAULTS command via I²C or power cycling SV_{IN} is necessary to restart the module, in such cases. Do not pull RUN logic high with a low impedance source. Use PGOODS2 and FAULTS2 to sequence on RUN_C0, and RUN_C1 for the dual 25A stage.

PGOOD_C0/PGOOD_C1 (R11/N5): Power Good Indicator Outputs. Open-drain logic output that is pulled to ground when the output exceeds the UV and OV regulation window. The output is deglitched by an internal 100 μ s filter. A pull-up resistor to 3.3V is required in the application.

FAULT_C0/FAULT_C1 (K10/K9): Digital Programmable FAULT Inputs and Outputs. Open-drain output. A pull-up resistor to 3.3V is required in the application.

COMP_0b/COMP_1b (N10/M7): Current Control Threshold and Error Amplifier Compensation Nodes. Each associated channel's current comparator tripping threshold increases with its Comp voltage. Each channel has a 22pF to SGND.

PIN FUNCTIONS

COMP_0a/COMP_1a (P11/M6): Loop Compensation Nodes. The internal PWM loop compensation resistors RCOMP_n of the LTM4664 can be adjusted using bit [4:0] of the MFR_PWM_COMP command. The transconductance of the LTM4664 PWM error amplifier can be adjusted using bit [7:5] of the MFR_PWM_COMP command. These two loop compensation parameters can be programmed when device is in operation. Refer to the Programmable Loop Compensation subsection in the 4:1 Divider Application Information section for further details. See MFR_PWM_COMP section.

SYNC (M8): External Clock Synchronization Input and Open-Drain Output Pin. If an external clock is present at this pin, the switching frequency will be synchronized to the external clock. If clock master mode is enabled, this pin will pull low at the switching frequency with a 500ns pulse to ground. A resistor pull-up to 3.3V is required in the application if the LTM4664 is the master.

SCL (L9): Serial Bus Clock Open-Drain Input (Can Be an Input and Output, if Clock Stretching is enabled). A pull-up resistor to 3.3V is required in the application for digital communication to the SMBus master(s) that nominally drive this clock. The LTM4664 will never encounter scenarios where it would need to engage clock stretching unless SCL communication speeds exceed 100kHz—and even then, LTM4664 will not clock stretch unless clock stretching is enabled by means of setting MFR_CONFIG_ALL[1] = 1b. The factory-default NVM configuration setting has MFR_CONFIG_ALL [1] = 0b: clock stretching disabled. If communication on the bus at clock speeds above 100 kHz is required, the user's SMBus master(s) needs to implement clock stretching support to assure solid serial bus communications, and only then should MFR_CONFIG_ALL [1] be set to 1b. When clock stretching is enabled, SCL becomes a bidirectional, open-drain output pin on LTM4664.

SDA (L8): Serial Bus Data Open-Drain Input and Output. A pull-up resistor to 3.3V is required in the application.

ALERT (J10): Open-Drain Digital Output. A pull-up resistor to 3.3V is required in the application only if SMBALERT interrupt detection is implemented in one's SMBus system.

SHARE_CLK (L7): Share_Clock, Bidirectional Open-Drain Clock Sharing Pin. Nominally 100kHz. Used for synchronizing the time base between multiple LTM4664s (and any other Linear Technology devices with a SHARE_CLK pin)—to realize well-defined rail sequencing and rail tracking. Tie the SHARE_CLK pins of all such devices together; all devices with a SHARE_CLK pin will synchronize to the fastest clock. A pull-up resistor to 3.3V is only required when synchronizing the time base between devices.

TSNS_C0a, TSNS_C0b (L10 and T16, Respectively): Channel 0 Temperature Excitation/Measurement and Thermal Sensor Pins, respectively. Connect TSNS_C0a to TSNS_C0b. This allows the LTM4664 to monitor the Power Stage Temperature of Channel 0.

TSNS_C1a, TSNS_C1b (M10 and T1, Respectively): Channel 1 Temperature Excitation/Measurement and Thermal Sensor Pins, respectively. In most applications, connect TSNS_C1a to TSNS_C1b. This allows the LTM4664 to monitor the Power Stage Temperature of Channel 1. See the Applications section.

WP (K7): Write Protect Pin, Active High. An internal 10 μ A current source pulls this pin to V_{DD33}. If WP is open circuit or logic high, only I²C writes to PAGE, OPERATION, CLEAR_FAULTS, MFR_CLEAR_PEAKS and MFR_EE_UNLOCK are supported. Additionally, Individual faults can be cleared by writing 1b's to bits of interest in registers prefixed with "STATUS". If WP is low, I²C writes are unrestricted.

PWM_C0, PWM_C1 (M15, L4): PWM drive signal to Channel 0, Channel 1 power stage. Utilized for debugging or monitoring purposes.

GL_C0, GL_C1 (P16, P5): Bottom MOSFET gate drive in the Channel 0 power stage, Channel 1 power stage. Utilized for debugging or monitoring purposes.

PHFLT_C0, PHFLT_C1 (M16, L5): Thermal Warning for Channel 0 and Channel 1. When the thermal protection threshold is tripped, the PHFLT_C_n pin is being pulled low. The power stage does not shut off, and is only a thermal monitor. These pins are internally pull up to 3.3V through 10k resistor.

4:1 DIVIDER BLOCK DIAGRAM

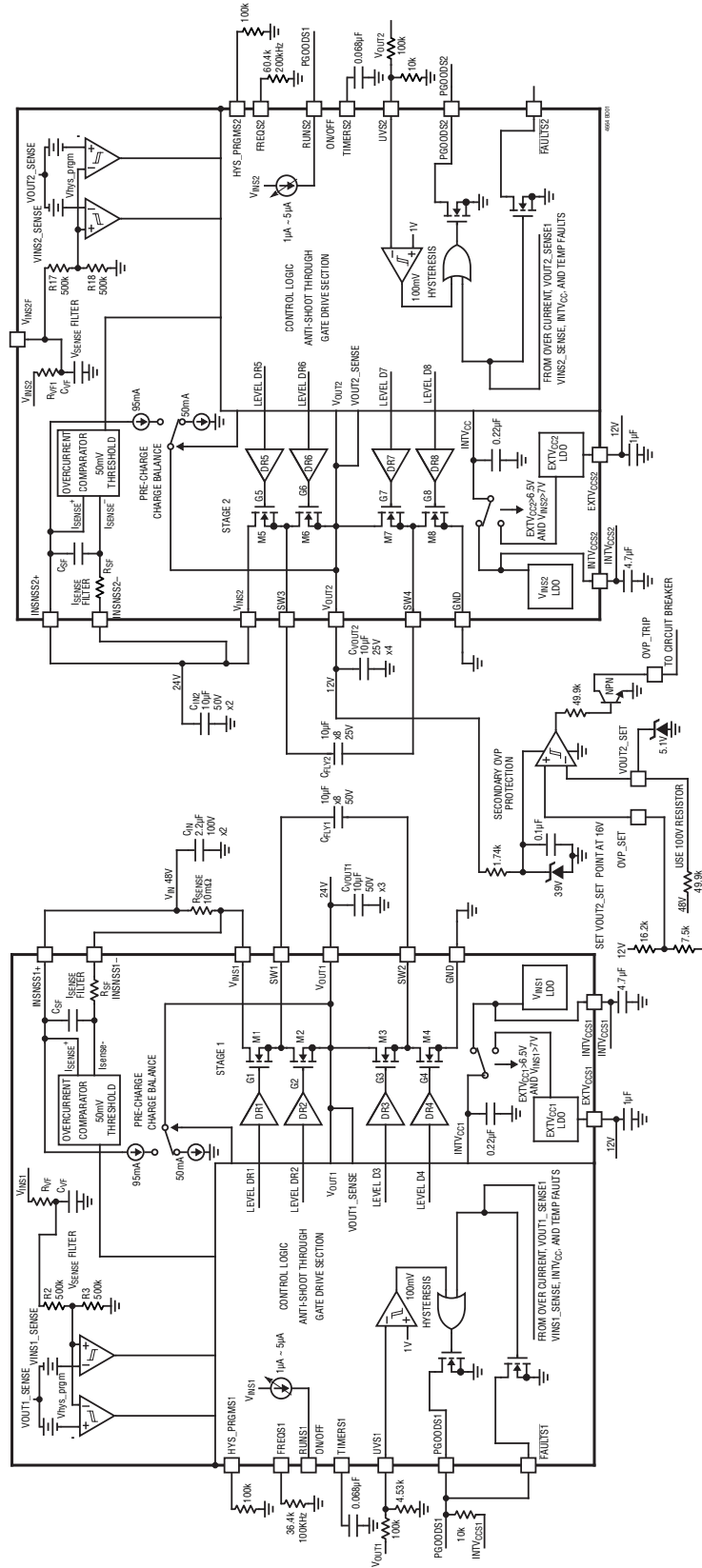

Figure 1. Simplified LTM4664 4:1 Divider Block Diagram

DUAL 25A POWER SYSTEM MANAGEMENT (PSM) BLOCK DIAGRAM

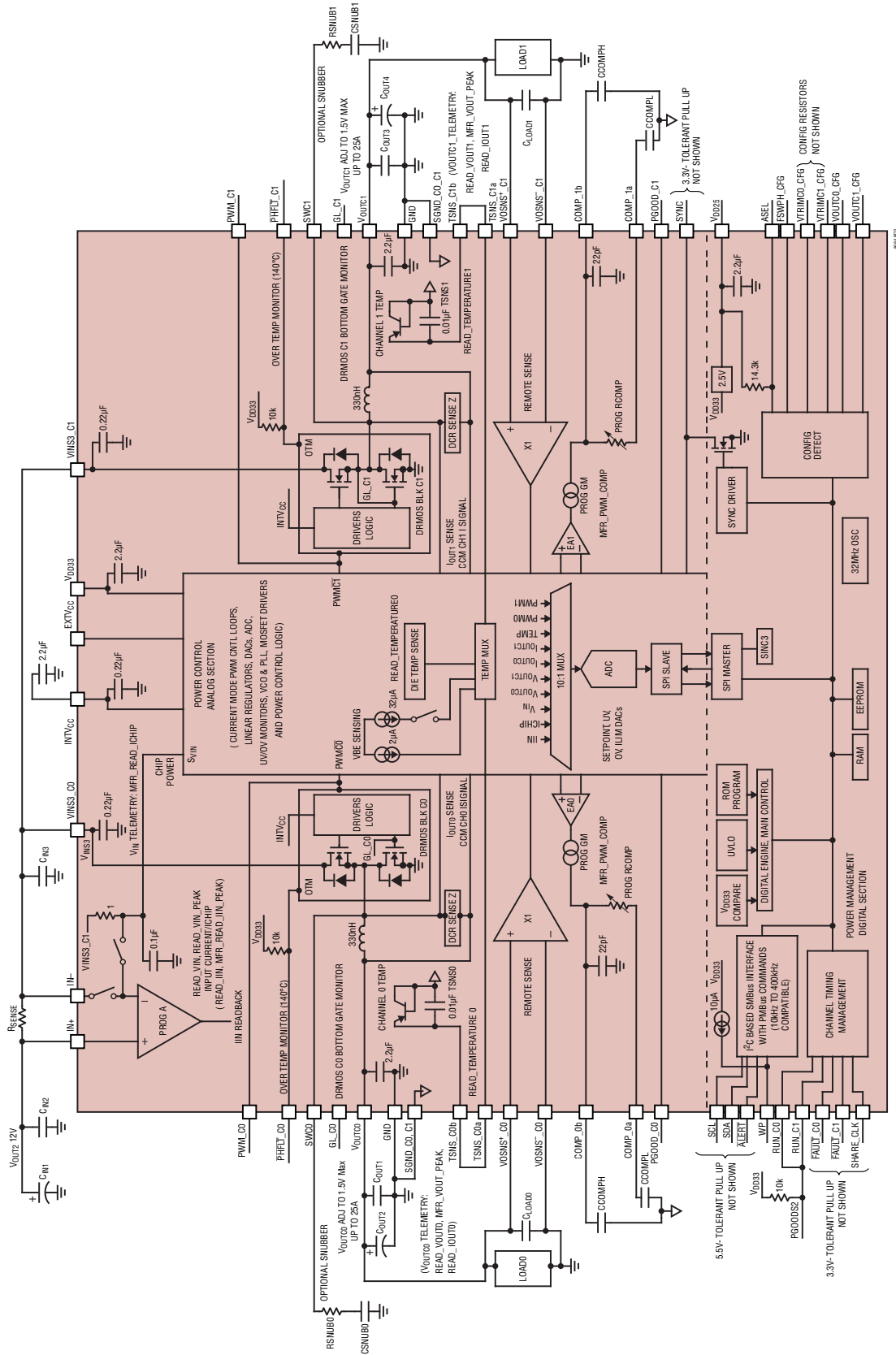

Figure 2. LTM4664 PSM Section Dual 25A PSM Block Diagram

4:1 DIVIDER OPERATION

4:1 DIVIDER DESCRIPTION

The LTM4664 incorporates a high performance 4:1 switched capacitor divider that divides down the input voltage by a factor of four over an input voltage range of 30V to 58V. This 4:1 divider then powers a dual 25A PMBUS compliant core power rails that can regulate from 0.5V to 1.5V. The LTM4664 will convert this high input range down directly to the low output voltages.

MAIN CONTROL

The LTM4664 internal 4:1 divider utilizes two constant frequency, open loop switched capacitor/charge pump stages for high voltage step down. The conversion efficiency is very high at ~99% for stage 1, and ~98.6% efficient for stage 2. Refer to Figure 1 for the block diagram. In stage 1 steady state operation, the N-channel MOSFETs M1 and M3 are turned on and off in the same phase with around 50% duty cycle at a pre-programmed 100 KHz switching frequency. The N-channel MOSFETs M2 and M4 are turned on and off complementary to MOSFETs M1 and M3. The gate drive waveforms are shown in Figure 3.

During phase 1, M1 and M3 are on and the flying capacitor C_{FLY1} is in series with C_{OUT1} . During phase 2, M2 and M4 are on and C_{FLY1} is in parallel with C_{OUT1} . The V_{OUT1}

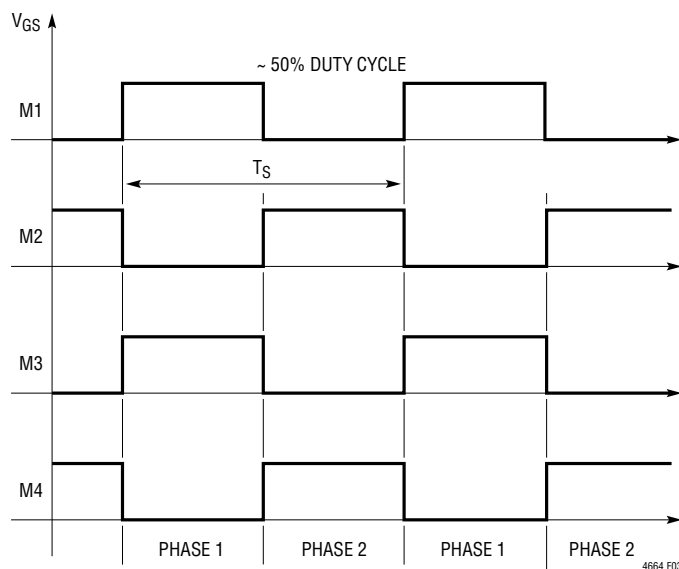

Figure 3. Stage 1 MOSFET Switching Waveforms

voltage is always close to half of the top voltage at the drain of MOSFET M1 (refer to GND pin) and in steady state and it is not sensitive to variable loads due to the very low impedance at its output. Stage 2 operates exactly the same way, the N-channel MOSFETs M5 and M7 are turned on and off in the same phase with around 50% duty cycle at a pre-programmed 300 kHz switching frequency. The N-channel MOSFETs M6 and M8 are turned on and off complementary to MOSFETs M5 and M7. The main input voltage rail is connected to V_{INS1} , and V_{OUT1} is connected directly into the V_{INS2} . The LTM4664 front end divider stages do not regulate the output voltage with a closed-loop feedback system. However, it stops switching when fault conditions occur, such as V_{OUT} pin overvoltage or undervoltage, an overcurrent event, or an over temperature protection event.

The V_{OUT2} ($V_{INS1}/4$) is connected to the V_{INS3_Cn} which is the inputs to the dual 25A PMBus channels. This will be discussed in more detail in the dual 25A operation section. There is a secondary fault protection comparator circuit that can be used to monitor V_{OUT2} for over voltage. This will be discussed in more detail in the application section. The LTM4664 can operate over a 30V to 58V input range that does have abrupt input voltage changes that move quicker than a few milliseconds after reaching steady state. See the window comparator section.

INTV_{CCS1,2}/EXTV_{CCS1,2} POWER

Power for the quad N-channel MOSFET drivers and most other internal circuitry is derived from the INTV_{CCS n} pin. Normally an internal 5.5V linear regulator supplies INTV_{CCS1,2} power from either V_{INS1} or V_{INS2} as indicated in Figure 1. Both of these input supplies have high input voltage, and increases power loss due to the LDO drop. An optional external voltage source on EXTV_{CCS1,2} pin enables a second 5.5V linear regulator and supplies INTV_{CCS1,2} power from the EXTV_{CCS1,2} pin. To enable this more efficient second regulator, $V_{INS1,2}$ has to be higher than 7V and the EXTV_{CCS1,2} pin voltage has to be higher than 6.5V. Do not exceed 40V on the EXTV_{CCS n} pin. Figure 1 shows the V_{OUT2} supply (12V) connected to both EXTV_{CCS1} and EXTV_{CCS2} to lower power loss in the LDO after startup.

4:1 DIVIDER OPERATION

Each of these can supply a peak current of 150mA. No matter what type of bulk capacitor is used, an additional 0.1 μ F ceramic capacitor placed directly adjacent to the INTV_{CCS_n} and GND pins is highly recommended. Good bypassing is needed to supply the high transient currents required by the MOSFET gate drivers. These high input voltages along with the power MOSFETs being driven at high frequencies may cause the maximum junction temperature rating for the LTM4664 to be exceeded. The INTV_{CCS_n} current, which is dominated by the gate charge current, may be supplied by either the 5.5V linear regulator from V_{INS_n} or the linear regulator from EXTV_{CCS_n}. When the voltage on the EXTV_{CCS_n} pin is less than 6.5V, the linear regulator from V_{INS_n} is enabled. Power dissipation for the internal controller in this case is highest and is equal to V_{INS_n} • IINTV_{CCS_n}. The gate charge current is dependent on operating frequency. This is why it is highly recommended to use the V_{OUT2} voltage to supply power to the EXTV_{CCS1,2} pins.

START-UP AND SHUTDOWN

The LTM4664 divider stages are in shutdown mode when their RUNS pins are pulled down and lower than 1.1V. In this mode, most internal circuitry is turned off including the INTV_{CCS1,2} regulators and the 4:1 divider consumes less than 200 μ A current per stage. All gates drives are actively pulled low to turn off the external power MOSFETs in shutdown. Releasing RUNS1,2 allows an internal 1 μ A current to pull up these pins and enable the controller stage. Once the RUNS1,2 pin raises above 1.22V, an additional 5 μ A is flowing out of the respective pin. Alternately, the RUNS pin may be externally pulled up or driven directly by logic. Do not exceed the Absolute Maximum Rating of 6V on these pins. After RUNS1,2 pin is released and the INTV_{CCS1,2} voltage passes UVLO, then that particular stage starts up and monitors the V_{IN_n} and V_{OUT_n} voltage continuously. The LTM4664 divider stages start switching only if the V_{OUT_n} voltage is close to half of the V_{INS_n} voltage or both V_{OUT_n} and V_{INS_n} voltages are close to GND. In voltage divider applications, V_{OUT1,2} is pre-balanced to half the V_{INS1,2} voltage and the LTM4664 divider stages may start up with capacitors at different initial conditions and balancing will be invoked if necessary.

FAULT PROTECTION AND THERMAL SHUTDOWN

The LTM4664 divider stages monitor system voltage, current and temperature for faults. The stage 1 or 2 stops switching and pulls down its FAULT pin when fault conditions occur. To clear voltage faults, the V_{OUT_n} pin voltage has to be within the programmed window around half of the V_{INS_n} voltage or the V_{INS_n} and V_{OUTS_n} voltages must be lower than 1V and 0.5V respectively. To clear current faults, the voltage drop from INSNS_n⁺ pin to INSNS_n⁻ pin has to be lower than 50mV. To clear temperature faults, the IC temperature has to be lower than 165°C. The FAULT pin is allowed to be pulled up by external resistors to voltages up to 60V. It can also be used to control disconnect FETs that isolates the input and output during fault conditions. See Figure 1 block diagram.

HIGH SIDE CURRENT SENSING

For over current protection, the LTM4664 uses a sensing resistor R_{SENSE} to monitor the current. The sensing resistor has to be placed at the drain of the very top MOSFET M1. See Typical Application section for examples. In most applications, the current through the sensing resistor is a pulse current and the peak value is much higher than the average load current. An internal RC filter on the I_{SENSE}⁻ pin, with a time constant lower than switching frequency, is used to set the precision average current protection. If over current protection is not desired, short the I_{SENSE}⁺ and I_{SENSE}⁻ pins together and connect them to the drain of top MOSFET M1 directly. This is done in stage 2 since stage 1 already monitors for current faults. See Figure 1.

FREQUENCY SELECTION

The selection of switching frequency is a trade-off between efficiency and component size. Low frequency operation increases efficiency by reducing MOSFET switching losses, but requires larger capacitance to maintain low output ripple voltage and low output impedance. The FREQS_n pin can be used to program the controller's operating frequency from 100 kHz to 1MHz. There is a precision 10 μ A current flowing out of the FREQS_n pin, so the user can program the controller's switching frequency

4:1 DIVIDER OPERATION

with a single resistor to GND. The voltage on the $FREQS_n$ pin is equal to the resistance multiplied by $10\mu\text{A}$ current (e.g. the voltage is 1V with a 100k resistor from the $FREQS_n$ pin to GND). A curve is provided below showing the relationship between the voltages on the $FREQS_n$ pin and switching frequency. Stage 1 is operated at 100kHz, and Stage 2 is operated at 200kHz for optimal efficiency. See Figure 4.

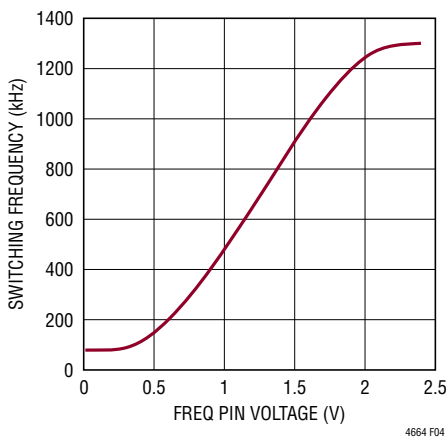

Figure 4. Relationship Between Switching Frequency and Voltage at FREQ Pin

$$f_{\text{sw}} (\text{kHz}) = R_{\text{FREQ}} (\text{k}\Omega) \cdot 8 - 317\text{kHz}$$

POWER GOOD AND UV (PGOODS_n AND UVS_n PINS)

When the UVS_n pin voltage is lower than 1V, the $PGOODS_n$ pin is pulled low. The $PGOODS_n$ pin is also pulled low when the $RUNS_n$ pin is low or when the LTM4664 divider stages are starting up. The $PGOODS_n$ pin is released only when the LTM4664 stage is switching and UVS_n pin is higher than 1V. The $PGOODS_n$ pin will flag power bad immediately when the UVS_n pin is low. However, there is an internal $20\mu\text{s}$ power good mask and 100mV hysteresis when UVS_n is higher than 1V. The $PGOODS_n$ pin is pulled up by external resistor to $INTV_{\text{CC}}$. The UVS_1 pin is used to monitor the $V_{\text{OUT}1}$ level for proper regulation, the $PGOODS_1$ signal is used to sequence on the stage 2's $RUNS_2$ pin. Then $PGOODS_2$ is used to sequence on the downstream dual 25A regulators. Proper setup on the UV pin to set a specific regulation point will release the $PGOOD_n$ pin when the output voltage is at that value. See Figure 1 block diagram.

ADDITIONAL OVERVOLTAGE PROTECTION

The OVP_SET , $V_{\text{OUT}2_SET}$, and OVP_TRIP pins can be used to monitor the $V_{\text{OUT}2}$ voltage for an overvoltage fault. These pins can be used in conjunction with the circuit in Figure 46 to provide a secondary OVP protection in and above the 4:1 divider fault protection. This feature can be used to trip off the input power, and further protect the low voltage outputs.

4:1 DIVIDER APPLICATION INFORMATION

A Typical Application in the Figure 1 block diagram shows the 4:1 voltage divider circuit. For the 1st stage voltage divider, the V_{INS1} input voltage is at the drain of very top MOSFET M1 and the output voltage is at the V_{OUT1} pin which is connected to the source of MOSFET M2 and the drain of MOSFET M3. The output voltage is around half of the input voltage in steady state. For the 2nd stage voltage divider, the V_{INS2} input voltage is at the drain of very top MOSFET M5 and the output voltage is at the V_{OUT2} pin which is connected to the source of MOSFET M6 and the drain of MOSFET M7. This completes the 4:1 divider.

For divider applications, if the load current is applied before startup or heavy resistive loads are connected to the V_{OUTn} pin, the divider stages may not start up due to the limited drive current of the pre-balance circuit.

Therefore the PGOODS1 signal is used to sequence on stage 2 RUN2 pin, and the PGOODS2 pin is used to stage on the dual 25A regulator.

VOLTAGE DIVIDER PRE-BALANCE BEFORE SWITCHING

In voltage divider applications, the V_{OUTn} voltage should be always close to V_{INSn}/2 in the steady state. The voltages on the flying capacitors (C_{FLYn}) and V_{OUTn} capacitors are all very close to each other and equal to the half of the input voltage. The charging inrush current is minimized during each switching cycle because the voltage difference between capacitors is small. However, without a special charging method such as the LTM4664 controller pre-charging circuitry, during start-up or fault conditions such as V_{OUTn} short to GND, the difference between capacitors can be large and huge charging currents may be large enough to cause very large MOSFETs currents. When switches M1 and M3 are on in the 1st stage, and M5 and M7 are on in the 2nd stage. Ideally, the inrush charge current is:

$$I = \frac{V_{INSn} - V_{CFLYn} - V_{OUTn}}{R_{ONMn} + R_{ONMn}}$$

When switches M2 and M4 are on or it is limited by the power MOSFET saturation current in the 1st stage, and M6 and M8 in the 2nd stage:

$$I = \frac{V_{CFLYn} - V_{OUTn}}{R_{ONMn} + R_{ONMn}}$$

With very low R_{DS(ON)} of the power MOSFETs, the inrush charge current could easily achieve several hundreds of Amperes which can be higher than the MOSFET's Safe Operating Area (SOA).

The LTM4664 provides a proprietary pre-balance method to minimize the inrush charging current in voltage divider applications. The LTM4664 controller detects the V_{OUTn} pin voltage before switching and compares it with the V_{INSn}/2 internally. If the V_{OUTn} pin voltage is much lower than the V_{INSn}/2, a current source will source 95mA current to the V_{OUTn} pin to pull the V_{OUTn} pin up. If the V_{OUTn} pin voltage is much higher than the V_{INSn}/2, another current source will sink 50mA from V_{OUTn} pin to pull the V_{OUTn} pin down.

If the V_{OUTn} pin voltage is close to V_{INSn}/2 and within the pre-programmed window, both current sources are disabled and the divider stages start switching. After 68 switching cycles and the V_{OUTn} pin is still within the window, the FAULTSn pin is released.

For the 4:1 voltage divider with pre-balance startup, the LTM4664 assumes no load current or very small load current (less than 50mA) at the V_{OUTn} (output) otherwise the V_{OUTn} cannot reach V_{INSn}/2 and LTM4664 never starts up. This no load condition can be achieved by connecting the PGOODn pin to the enable pins of the following electrical loads. If load current cannot be controlled off such as resistive loads, a disconnected FETs is required to disconnect the load to the V_{OUTn} during startup as shown in the typical applications. The input power source can operate over the 30V to 58V range, but the supply variation needs to be constrained to move much slower than the switching frequency and not exceed the hysteresis set by the HYS_PRGMsn pin. Large fast voltage excursions

4:1 DIVIDER APPLICATION INFORMATION

changes will force the 4:1 divider into pre-balance phase. Usually front end circuit breakers control the rate change and slew rate on the main input power which will eliminate this problem. As long as the input supply moves much slower than the operating frequency of the 4:1 divider, then the regulator will be able to balance without a need to pre-balance.

OVERCURRENT PROTECTION

The LTM4664 4:1 divider provides overcurrent protection through a sensing resistor placed on the high voltage side. A precision rail to rail comparator monitors the differential voltage between $INSN_{SSn^+}$ pin and $INSN_{SSn^-}$ pin which are Kelvin connected to a sensing resistor. Whenever the $INSN_{SSn^+}$ pin voltage is 50mV higher than $INSN_{SSn^-}$ pin voltage, overcurrent fault is triggered and the $\overline{FAULTSn}$ pin is pulled down to ground. At the same time the divider stage stops switching and starts retry mode based on the timer pin setup. The overcurrent fault will be cleared when the $TIMERSn$ pin voltage reaches 4V and the voltage across the sensing resistor is less than 50mV.

The current through the sensing resistor is a pulse current during charging/discharging of the flying capacitors, which may result a voltage higher than the 50mV threshold at heavy loads. To prevent the inrush current from falsely triggering the overcurrent protection, an RC filter is required at the $INSN_{SSn^+}$ pin and $INSN_{SSn^-}$. The RC filter timer constant has to be larger than a switching period. Typically a 100 Ω and 0.1 μ F filter is good for most of applications, and this filter is already included inside the LTM4664. The current limit can be selected by choosing different sense resistor values. For example, 10m Ω sensing resistor sets current limit at 50mV/10m Ω = 5A ideally. Due to the switching ripple, the actual current limit is always lower than the ideal case. In real circuits, the current limit is around 4.2A with the 0.1 μ F/100 Ω filter and 200kHz switching frequency. If overcurrent protection is not used, short $INSN_{SSn^+}$ pin and $INSN_{SSn^-}$ pin together and connect them to the drain of the top as shown in Figure 1 stage 2. Stage 2 current limit is not usually necessary since stage 1 already has it implemented. Also the dual 25A regulators have overcurrent protection discussed later in the data sheet.

WINDOW COMPARATOR PROGRAMMING

In normal operation, V_{OUTn} voltage should be always close to half of the V_{INSn} voltage. A floating window comparator monitors the voltage on the V_{OUTn} pin and compares it with $V_{INSn}/2$. The window hysteresis voltage can be programmed and is equal to the voltage at the HYS_PRGMSn pin. There is a precision 10 μ A current flowing out of HYS_PRGMSn pin. A single resistor from HYS_PRGMSn pin to GND sets the HYS_PRGMSn pin voltage, which equals the resistor value multiplied by 10 μ A current (e.g. the voltage is 1V with a 100k resistor from the HYS_PRGMSn pin to GND). With a 100k resistor on the HYS_PRGMSn pin, the $V_{INSn}/2$ voltage has to be within ($V_{OUTn} \pm 1V$) window during startup and normal operation, otherwise a fault is triggered and the LTM4664 divider stages stop switching.

The window hysteresis voltage can be linearly programmed from 0.3V to 2.4V with different resistor values on HYS_PRGMSn pin. If the HYS_PRGMSn pin is tied to $INTV_{CC}$, a default 0.8V hysteresis window is applied internally. The hysteresis window voltage has to be programmed large enough to tolerate the V_{OUTn} pin voltage ripple and voltage drop at maximum load conditions. See Figure 5. Small internal RC filters are used on these two pins to reject noise higher than the switching frequency.

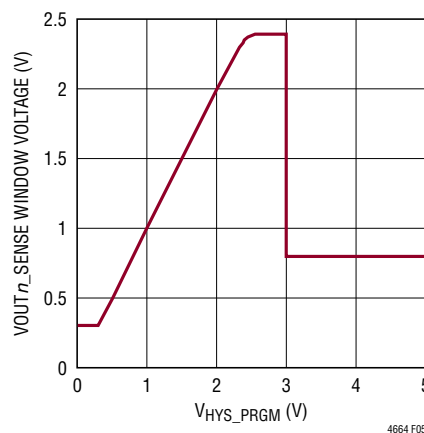

Figure 5. Relationship Between HYS_PRGM Pin Voltage and V_{OUTn_SENSE} Window Comparator Voltage

4:1 DIVIDER APPLICATION INFORMATION

EFFECTIVE OPEN LOOP OUTPUT RESISTANCE AND LOAD REGULATION

The LTM4664 divider stages do not regulate the output voltage through a closed loop feedback system. However, the output voltage is not sensitive to load conditions due to the low output resistance when it is operating with a certain quantity of flying capacitors and high switching frequency. The Thevenin equivalent circuit of voltage divider circuit is shown in the Figure 6.

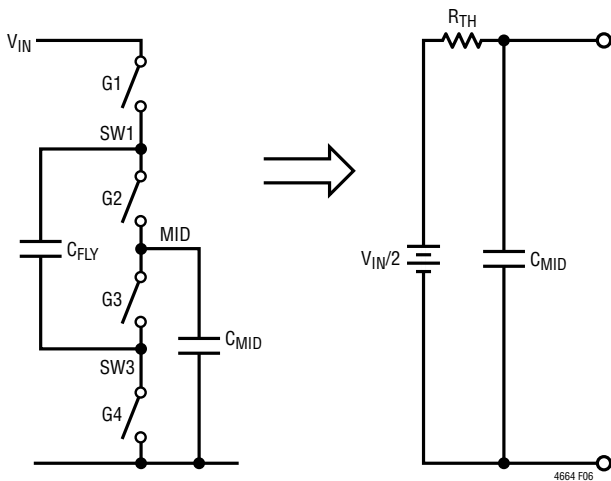

Figure 6.

When duty cycle is around 50%:

$$R_{OUT} = \frac{1 + e^{-\frac{1}{4f_s R_{DS(ON)} C_{FLY}}}}{4f_s C_{FLY} \left(1 - e^{-\frac{1}{4f_s R_{DS(ON)} C_{FLY}}}} \right)}$$

Where:

f_s is the switching frequency.

C_{FLY} is the flying capacitor.

$R_{DS(ON)}$ is the on resistance of one MOSFET.

At low switching frequencies, $R_{TH} = 1/(4f_s C_{FLY})$. As frequency increases, the R_{TH} will finally approach $2R_{DS(ON)}$. In high power applications, it is suggested to select the switching frequency around $1/(16C_{FLY} R_{DS(ON)})$ or higher for decent load regulation and efficiency. At heavy load

conditions, the output voltage will drop from $V_{INSn}/2$ by $R_{TH} \cdot I_{LOAD}$. In many applications, multi-layer ceramic capacitors (MLCC) are selected as flying capacitors. The voltage coefficients of MLCC capacitors strongly depend on the type and size of capacitors. Normally larger size X7R MLCC capacitors are better than X5R in terms of voltage coefficient. The capacitance still drops 20% to 30% capacitance with high DC bias voltage. Capacitance derating needs to be considered when estimating the output resistance of the switched capacitor circuits.

UNDERVOLTAGE LOCKOUT

The LTM4664 divider stages have a precision UVLO comparator constantly monitoring the $INTV_{CCSn}$ voltage to ensure that an adequate gate drive voltage is present. It locks out the switching action when $INTV_{CCSn}$ is below 4.9V. To prevent oscillation when there is a disturbance on the $INTV_{CCSn}$, the UVLO comparator has 200mV of precision hysteresis. Another way to detect an under voltage condition is to monitor the input supply. Because the RUN pin has a precision turn-on reference of 1.22V, one can use a resistor divider to the V_{INSn} to turn on the stage when the input voltage is high enough. An extra 5 μ A of current flows out of the RUN pin once the $RUNS_n$ pin voltage passes 1.22V. One can program the hysteresis of the $RUNS_n$ comparator by adjusting the values of the resistive divider.

FAULT RESPONSE AND TIMER PROGRAMMING

The LTM4664 divider stages stop switching and pull the $FAULTSn$ pins low during fault conditions. A capacitor connected from the $TIMERS_n$ pin to GND sets retry time to start-up if fault conditions are removed. The typical waveform on $TIMERS_n$ pin during fault condition is shown in Figure 7.

After the $FAULTSn$ pin is pulled low, a 3.5 μ A pull-up current flows out of $TIMER$ pin and starts to charge the $TIMERS_n$ capacitor. The pull-up current increases to 7 μ A when then $TIMERS_n$ pin voltage is higher than 0.5V and back to 3.5 μ A when the $TIMERS_n$ pin voltage is higher than 1.2V. The $TIMERS_n$ pin will be strongly pulled down whenever the fault conditions are removed or the $TIMERS_n$ pin voltage is higher than 4V. When the $TIMERS_n$ pin voltage is

Rev. A

4:1 DIVIDER APPLICATION INFORMATION

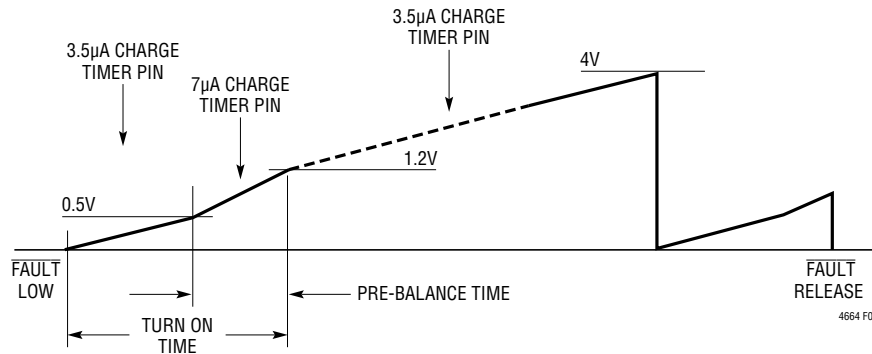

Figure 7. Timer Behavior During Fault or Startup

between 0.5V and 1.2V, the internal pre-balance circuit will source or sink current to the V_{OUTn} pin and regulate the V_{OUTn} pin to $V_{INSn}/2$ with around 95mA/50mA capability. The pre-balance time can be calculated based on the capacitor $C_{TIMERSn}$ on the $TIMERSn$ pin: $T_{PRE-BALANCE} = C_{TIMER} \cdot 0.7V/7\mu A$, so the pre-balance time is 100ms/ μF (e.g. the pre-balance time is 10ms with 0.1 μF C_{TIMER}). For voltage divider applications, if the flying capacitor C_{FLYn} and the V_{OUTn} capacitor are very large and input voltage is high, it may take several pre-balance time periods to pre-balance the V_{OUTn} pin to $V_{INSn}/2$ with a fixed C_{TIMER} . A longer start-up time is expected. Assuming zero initial conditions, the time to charge the capacitors, τ_{charge} can be estimated from the equation:

$$\tau_{Charge} = (C_{OUT} + C_{FLY}) \cdot (V_{IN} / 2 / 93mA)$$

Keep in mind that the approximate capacitor value will be the value at both voltage bias and temperature, this information can be derived from the capacitor data sheet curves.

Input/Output Capacitor and Flying Capacitor Selection

In high power switched capacitor applications, large AC currents flow through the flying capacitors and input/output capacitors. Low ESR ceramic capacitors are highly recommended for high power switch capacitor applications.

Make sure the maximum RMS capacitor current is within the spec or higher rated capacitors are preferred. Note that capacitor manufacturers' ripple current ratings are often based on only 2000 hours of life. This makes it advisable to further derate the capacitor.

Design Example

As a design example using LTM4664 divider stages for a the 4:1 divider at 72W, assume $V_{INS1} = 48V$ (nominal), $V_{INS1} = 60V$ (maximum), $V_{OUT1} = 24V$ (nominal), $I_{OUT1} = 3A$ (maximum) for stage 1. For high power and high voltage applications, always start with a low switching frequency e.g. 100kHz to minimize the switching losses. To set the stage 1 to 100kHz switching frequency, a 36.5k 1% resistor is connected from $FREQS1$ pin to ground. Set the C_{FLY1} voltage ripple to be 2% of the output voltage is a good starting point with tradeoff between efficiency and power density. The C_{FLY1} can be calculated based on the equation below:

$$I_{OUT1(MAX)} = 3A$$

$$C_{FLY} = \frac{I_{OUT1(MAX)}}{2 \cdot f_{SW} \cdot V_{CFLY1(RIPPLE)}}$$

$$\sim 31\mu F = \frac{3A}{2 \cdot 100kHz \cdot 0.48V}$$

Consider the ceramic capacitance derating at 24VDC bias voltage, 8 of 10 μF /X7R/50V ceramic capacitors are paralleled as flying capacitors.

The 4:1 divider at 72W, assume $V_{INS2} = 24V$ (nominal), $V_{IN} = 30V$ (maximum), $V_{OUT2} = 12V$ (nominal), $I_{OUT2} = 6A$ (maximum) for stage 2. For stage 2 start with a switching frequency of 200kHz to minimize the switching losses. To set the 200kHz switching frequency, a 60.4k 1% resistor is connected from $FREQS2$ pin to ground. Set the C_{FLY2} voltage ripple to be 2% of the output voltage is a good starting

4:1 DIVIDER APPLICATION INFORMATION

point with trade-off between efficiency and power density. The C_{FLY2} can be calculated based on the equation below:

$$I_{OUT2(MAX)} = 6A$$

$$C_{FLY} = \frac{I_{OUT2(MAX)}}{2 \cdot f_{SW} \cdot V_{CFLY2(RIPPLE)}}$$

$$\sim 62\mu F = \frac{6A}{2 \cdot 200kHz \cdot 0.24V}$$

Consider the ceramic capacitance derating at 12VDC bias voltage, 8 of 10 μ F/X7R/50V ceramic capacitors are paralleled as flying capacitors.

Consider the ceramic capacitance derating at 24V and 12V DC bias voltage.

The worst case RMS current may be 40% higher than the maximum output current. So the worst case RMS on each capacitor can be estimated by this equation:

$$I_{RMS1(MAX)} = \frac{I_{OUT1(MAX)} \cdot 140\%}{N},$$

$N = \#$ of C_{FLY1} capacitor s in parallel in stage1

$$0.525A = \frac{3A \cdot 1.4}{8}$$

Each capacitor is rated for 2A IRMS, no issue

$$I_{RMS2(MAX)} = \frac{I_{OUT2(MAX)} \cdot 140\%}{N},$$

$N = \#$ of C_{FLY1} capacitor s in parallel in stage1

$$1.05A = \frac{6A \cdot 1.4}{8}$$

The output capacitor selection is similar to the flying capacitor selection. More output capacitors result smaller output voltage ripple. The output capacitor has less than 1/3 the CFLY RMS current, and the output capacitor can be much less than the flying capacitor. Some of output capacitors may be connected between input and output to serve as input capacitors at the same time. However the voltage rating of those capacitors has to be selected based on the input voltage instead of the output voltage.

Capacitors to use for 4:1 Divider

Capacitor Vendor	Value (μ F)	Voltage (V)	Part Number
Murata	10	50	GRM32ER71H106KA12
TDK	10	50	C3225X7R1H106M250AC
Murata	22	25	GRM32ER71G226KE15L
Taiyo Yuden	22	25	TMK325BJ226MMHT

DUAL 25A PSM OPERATION

The LTM4664 Power System Management (PSM) includes a highly configurable dual 25A output standalone nonisolated switching mode step-down DC/DC power supply with built-in EEPROM NVM (non-volatile memory) with ECC and I²C-based PMBus/SMBus 2-wire serial communication interface capable of 400kHz SCL bus speed. Two output voltages can be regulated (V_{OUT0} , V_{OUT1} —collectively, V_{OUTn}) with a few external input and output capacitors and pull-up resistors. Readback telemetry data of input and output voltages and input and output currents, and module temperatures are continually digitized cyclically by an integrated 16-bit ADC (analog-to-digital converter). Many fault thresholds and responses are customizable. Data can be autonomously saved to EEPROM when a fault occurs, and the resulting fault log can be retrieved over I²C at a later time, for analysis. See Figure 2 for Block Diagram.

PSM SECTION OVERVIEW, MAJOR FEATURES

Major Features Include:

- Dedicated Power Good Indicators
- Direct Input and Chip Current Sensing
- Programmable Loop Compensation Parameters
- T_{INIT} Start-Up Time: 30ms
- PWM Synchronization Circuit, (See Frequency and Phasing Section for Details)
- MFR_ADC_CONTROL for Fast ADC Sampling of One Parameter (as Fast as 8ms) (See PMBus Command for Details)
- Fully Differential Output Sensing for Both Channels; V_{OUT0}/V_{OUT1} Both Programmable Up to 1.5V
- Power-Up and Program EEPROM with EXT_{VCC}
- Input Voltage Up to 18V
- ΔV_{BE} Temperature Sensing
- SYNC Contention Circuit (Refer to Frequency and Phase Section for Details)
- Fault Logging
- Programmable Output Voltage

- Programmable Input Voltage On and Off Threshold Voltage
- Programmable Current Limit per channel
- Programmable Switching Frequency
- Programmable OV and UV Threshold voltage
- Programmable ON and Off Delay Times
- Programmable Output Rise/Fall Times
- Phase-Locked Loop for Synchronous PolyPhase Operation (2, 3, 4 or 6 Phases)
- Nonvolatile Configuration Memory with ECC
- Optional External Configuration Resistors for Key Operating Parameters
- Optional Timebase Interconnect for Synchronization Between Multiple Controllers
- WP Pin to Protect Internal Configuration
- Stand Alone Operation After User Factory Configuration
- PMBus, Version 1.2, 400kHz Compliant Interface

The PMBus interface provides access to important power management data during system operation including:

- Internal Controller Temperature
- Internal Power Channel Temperature Average OutputCurrent
- Average Output Voltage
- Average Input Voltage
- Average Input Current
- Average Chip Input Current from V_{IN}
- Configurable, Latched and Unlatched Individual Fault and Warning Status

Individual channels are accessed through the PMBus using the PAGE command, i.e., PAGE 0 or 1.

Fault reporting and shutdown behavior are fully configurable. Two individual $\overline{FAULT_C0}$, $\overline{FAULT_C1}$ outputs are provided, both of which can be masked independently.

DUAL 25A PSM OPERATION

Three dedicated pins for $\overline{\text{ALERT}}$, PGOOD_C0/PGOOD_C1 functions are provided. The shutdown operation also allows all faults to be individually masked and can be operated in either unlatched (hiccup) or latched modes.

Individual status commands enable fault reporting over the serial bus to identify the specific fault event. Fault or warning detection includes the following:

- Output Undervoltage/Overvoltage
- Input Undervoltage/Overvoltage
- Input and Output Overcurrent
- Internal Overtemperature
- Communication, Memory or Logic (CML) Fault

EEPROM WITH ECC

The LTM4664 PSM Dual 25A Regulators contain internal EEPROM with ECC (Error Correction Coding) to store user configuration settings and fault log information. EEPROM endurance retention and mass write operation time are specified in the Electrical Characteristics and Absolute Maximum Ratings sections. Write operations above $T_J = 85^\circ\text{C}$ are possible although the Electrical Characteristics are not guaranteed and the EEPROM will be degraded. Read operations performed at temperatures between -40°C and 125°C will not degrade the EEPROM. Writing to the EEPROM above 85°C will result in a degradation of retention characteristics. The fault logging function, which is useful in debugging system problems that may occur at high temperatures, only writes to fault log EEPROM locations. If occasional writes to these registers occur above 85°C , the slight degradation in the data retention characteristics of the fault log will not take away from the usefulness of the function.

It is recommended that the EEPROM not be written when the die temperature is greater than 85°C . If the die temperature exceeds 130°C , the LTM4664 PSM will disable all EEPROM write operations. All EEPROM write operations will be reenabled when the die temperature drops below 125°C . (The controller will also disable all the switching when the die temperature exceeds the internal overtemperature fault limit 160°C with a 10°C hysteresis).

The degradation in EEPROM retention for temperatures $>125^\circ\text{C}$ can be approximated by calculating the dimensionless acceleration factor using the following equation:

$$AF = e^{\left[\left(\frac{E_a}{k} \right) \cdot \left(\frac{1}{T_{\text{USE}} + 273} - \frac{1}{T_{\text{STRESS}} + 273} \right) \right]}$$

where:

AF = acceleration factor

E_a = activation energy = 1.4eV

$K = 8.617 \cdot 10^{-5} \text{ eV}/^\circ\text{K}$

$T_{\text{USE}} = 125^\circ\text{C}$ specified junction temperature

T_{STRESS} = actual junction temperature in $^\circ\text{C}$

Example: Calculate the effect on retention when operating at a junction temperature of 135°C for 10 hours.

$$T_{\text{STRESS}} = 130^\circ\text{C}$$

$$T_{\text{USE}} = 125^\circ\text{C},$$

$$AF = e^{((1.4/8.617 \cdot 10^{-5}) \cdot (1/398 - 1/403))} = 16.6$$

The equivalent operating time at $125^\circ\text{C} = 16.6$ hours.

Thus the overall retention of the EEPROM was degraded by 16.6 hours as a result of operating at a junction temperature of 130°C for 10 hours. The effect of the over-stress is negligible when compared to the overall EEPROM retention rating of 87,600 hours at a maximum junction temperature of 125°C .

The integrity of the entire onboard EEPROM is checked with a CRC calculation each time its data is to be read, such as after a power-on reset or execution of a RESTORE_USER_ALL command. If a CRC error occurs, the CML bit is set in the STATUS_BYTE and STATUS_WORD commands, the EEPROM CRC Error bit in the STATUS_MFR_SPECIFIC command is set, and the $\overline{\text{ALERT}}$ and RUN pins pulled low (PWM channels off). At that point the device will only respond at special address $0x7C$, which is activated only after an invalid CRC has been detected. The chip will also respond at the global addresses $0x5A$ and $0x5B$, but use of these addresses when attempting to recover from a CRC issue is not recommended. All power supply rails associated with either PWM channel of a device reporting an invalid CRC should remain disabled until the issue is resolved. See the application Information

DUAL 25A PSM OPERATION

section or contact the factory for details on efficient in-system EEPROM programming, including bulk EEPROM Programming, which the LTM4664 PSM also supports.

The LTM4664 PSM contains dual integrated constant frequency current mode control buck regulators (channel 0 and channel 1) whose built-in power MOSFETs are capable of fast switching speed. The factory NVM-default switching frequency clocks SYNC at 350kHz, to which the regulators synchronize their switching frequency. The default phase-interleaving angle between the channels is 180°. A pin-strapping resistor on FSWPH_CFG configures the frequency of the SYNC clock (switching frequency) and the channel phase relationship of the channels to each other and with respect to the falling edge of the SYNC signal. (Most possible combinations of switching frequency and phase-angle assignments are settable by resistor pin programming; see Table 3. Configure the LTM4664's PSM NVM to implement settings not available by resistor-pin strapping.) When a FSWPH_CFG pin-strap resistor sets the channel phase relationship of the LTM4664's PSM channels, the SYNC clock is not driven by the module; instead, SYNC becomes strictly a high impedance input and channel switching frequency is then synchronized to SYNC provided by an externally-generated clock or sibling LTM4664 with pull-up resistor to V_{DD33} . Switching frequency and phase relationship can be altered via the I²C interface, but only when switching action is off, i.e., when the module is not regulating either output. See the Dual 25A PSM Applications Information section for details.

Programmable analog feedback loop compensation for channel 0 and channel 1 is accomplished with a capacitor connection from COMP_C0a, 1a to SGND, and a capacitor from COMP_C0b, 1b to SGND.) The COMP_C0b, 1b pin is for the high frequency gain roll off and is the g_m amplifier output that has a programmable range, and the COMP_C0a, 1a pin has the programmable resistor range along with a capacitor to SGND that sets the frequency compensation. See Programmable Loop Compensation section. The LTM4664 Dual 25A Regulators module have sufficient stability margins and good transient performance with a wide range of output capacitors—even all-ceramic MLCCs. Table 12 provides guidance on input and output capacitors recommended for many common operating conditions along with the programmable compensation

settings. The Linear Technology LTpowerCAD tool is available for transient and stability analysis, and experienced users who prefer to adjust the module's feedback loop compensation parameters can use this tool.

POWER-UP AND INITIALIZATION

The LTM4664 Dual 25A Regulators are designed to provide standalone supply sequencing and controlled turn-on and turn-off operation. It operates from a single input supply (4.5V to 16V) while three on-chip linear regulators generate internal 2.5V, 3.3V and 5.5V. The controller configuration is initialized by an internal threshold based UVLO where V_{IN} must be approximately 4V and the 5.5V, 3.3V and 2.5V linear regulators must be within approximately 20% of the regulated values. In addition to the power supply, a PMBus RESTORE_USER_ALL or MFR_RESET command can initialize the part too.

The EXTV_{CC} pin is driven by an external regulator to improve efficiency of the circuit and minimize power loss when V_{INS3} is high. The EXTV_{CC} pin must exceed approximately 4.7V, and V_{INS3} must exceed approximately 7V before the INTV_{CC} LDO operates from the EXTV_{CC} pin. To minimize application power, the EXTV_{CC} pin can be supplied by a switching regulator.

During initialization, the external configuration resistors are identified and/or contents of the NVM are read into the controller's commands and the power train is held off. The RUN_Cn and FAULT_Cn and PGOOD_Cn are held low. The LTM4664 Dual 25A Regulators will use the contents of Table 1 thru Table 5 to determine the resistor defined parameters. See the Resistor Configuration section for more details. The resistor configuration pins only control some of the preset values of the controller. The remaining values are programmed in NVM either at the factory or by the user.

If the configuration resistors are not inserted or if the ignore RCONFIG bit is asserted (bit 6 of the MFR_CONFIG_ALL configuration command), the LTM4664 PSM will use only the contents of NVM to determine the DC/DC characteristics. The ASEL value read at power-up or reset is always respected unless the pin is open. The ASEL will set the bottom 4LSBs and the MSBs are set by NVM. See the Dual 25A PSM Applications Information section for more details.

DUAL 25A PSM OPERATION

After the part has initialized, an additional comparator monitors V_{INS3} . The VIN_ON threshold must be exceeded before the output power sequencing can begin. After V_{IN} is initially applied, the part will typically require 70ms to initialize and begin the TON_DELAY timer. The readback of voltages and currents may require an additional 0ms to 90ms.

SOFT-START

The method of start-up sequencing described below is time-based. The part must enter the run state prior to soft-start. Stage 2 of the 4:1 Divider will release RUN_C0 and RUN_C1 once it has reached regulation defined by the program valve set by UV_{S2} , and $FAULT_n$ is released. The RUN_Cn pins are released by the LTM4664 PSM after the part is initialized and V_{INS3} is greater than the VIN_ON threshold. If multiple LTM4664 PSMs are used in an application, they all hold their respective RUN_Cn pins low until all devices are initialized and V_{INS3} exceeds the VIN_ON threshold for every device. The $SHARE_CLK$ pin assures all the devices connected to the signal use the same time base. The $SHARE_CLK$ pin is held low until the part has been initialized after V_{INS3} is applied. The LTM4664 PSM can be set to turn-off (or remain off) if $SHARE_CLK$ is low (set bit 2 of MFR_CHAN_CONFIG to 1). This allows the user to assure synchronization across numerous PSM devices even if the RUN_Cn pins cannot be connected together due to board constraints. In general, if the user cares about synchronization between chips it is best not only to connect all the respective RUN_Cn pins together but also to connect all the respective $SHARE_CLK$ pins together and pulled up to V_{DD33} with a 10k resistor. This assures all chips begin sequencing at the same time and use the same time base.

After the RUN_Cn pins release and prior to entering a constant output voltage regulation state, the LTM4664 PSM performs a monotonic initial ramp or “soft-start” on each of the 25A outputs. Soft-start is performed by actively regulating the load voltage while digitally ramping the target voltage from 0V to the commanded voltage set-point. Once the LTM4664 25A Regulators are commanded to turn on (after power up and initialization), the controller waits for the user specified turn-on delay (TON_DELAY)

prior to initiating this output voltage ramp. The rise time of the voltage ramp can be programmed using the TON_RISE command to minimize inrush currents associated with the start-up voltage ramp. The soft-start feature is disabled by setting the value of TON_RISE to any value less than 0.25ms. The LTM4664 PWM_Cn always uses discontinuous mode during the TON_RISE operation. In discontinuous mode, the bottom MOSFET is turned off as soon as reverse current is detected in the inductor. This will allow the regulator to start up into a prebiased load. When the $TON_MAX_FAULT_LIMIT$ is reached, the part transitions to continuous mode, if so programmed. If $TON_MAX_FAULT_LIMIT$ is set to zero, there is no time limit and the part transitions to the desired conduction mode after TON_RISE completes and V_{OUT} has exceeded the $V_{OUT_UV_FAULT_LIMIT}$ and I_{OUT_OC} is not present. However, setting $TON_MAX_FAULT_LIMIT$ to a value of 0 is not recommended.

TIME-BASED SEQUENCING

The default mode for sequencing the outputs on and off is time-based. Each output is enabled after waiting TON_DELAY amount of time following either a RUN_Cn pin going high, a PMBus command to turn on or the V_{IN} rising above a preprogrammed voltage. Off sequencing is handled in a similar way. To assure proper sequencing, make sure all ICs connect the $SHARE_CLK$ pin together and RUN_Cn pins together. If the RUN_Cn pins cannot be connected together for some reasons, set bit 2 of MFR_CHAN_CONFIG to 1. This bit requires the $SHARE_CLK$ pin to be clocking before the power supply output can start. When the RUN_Cn pin is pulled low, the LTM4664 PSM will hold the pin low for the $MFR_RESTART_DELAY$. The minimum $MFR_RESTART_DELAY$ is $TOFF_DELAY + TOFF_FALL + 136ms$. This delay assures proper sequencing of all rails. The LTM4664 PSM calculates this delay internally and will not process a shorter delay. However, a longer commanded $MFR_RESTART_DELAY$ can be used by the part. The maximum allowed value is 65.52 seconds.

VOLTAGE-BASED SEQUENCING

The sequence can also be voltage-based. As shown in Figure 8, The $PGOOD_Cn$ pins are asserted when the UV

DUAL 25A PSM OPERATION

threshold is exceeded for each output. It is possible to feed the PGOOD_Cn pin from one LTM4664 PSM channel into the RUN_Cn pin of the next LTM4664 PSM channel in the sequence, especially across multiple LTM4664s. The PGOOD_Cn has a 60 μ s filter. If the V_{OUT} voltage bounces around the UV threshold for a long period of time it is possible for the PGOOD_Cn output to toggle more than once. To minimize this problem, set the TON_RISE time under 100ms.

If a fault in the string of rails is detected, only the faulted rail and downstream rails will fault off. The rails in the string of devices in front of the faulted rail will remain on unless commanded off.

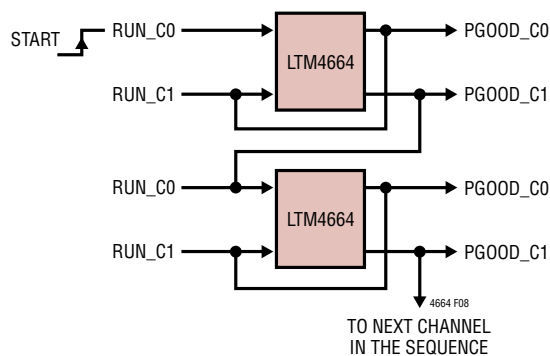

Figure 8. Event (Voltage) Based Sequencing

SHUTDOWN

The LTM4664 PSM Regulators supports two shutdown modes. The first mode is closed-loop shutdown response, with user defined turn-off delay (TOFF_DELAY) and ramp down rate (TOFF_FALL). The controller will maintain the mode of operation for TOFF_FALL. The second mode is discontinuous conduction mode, the controller will not draw current from the load and the fall time will be set by the output capacitance and load current, instead of TOFF_FALL.

The shutdown occurs in response to a fault condition or loss of SHARE_CLK (if bit 2 of MFR_CHAN_CONFIG is set to a 1) or V_{IN} falling below the VIN_OFF threshold or FAULT pulled low externally (if the MFR_FAULT_RESPONSE is set to inhibit). Under these conditions, the power stage is disabled in order to stop the transfer of energy to the load as quickly as possible. The shutdown state can be entered from the soft-start or active regulation states or through user intervention.

There are two ways to respond to faults; which are retry mode and latched off mode. In retry mode, the controller responds to a fault by shutting down and entering the inactive state for a programmable delay time (MFR_RETRY_DELAY). This delay minimizes the duty cycle associated with autonomous retries if the fault that causes the shutdown disappears once the output is disabled. The retry delay time is determined by the longer of the MFR_RETRY_DELAY command or the time required for the regulated output to decay below 12.5% of the programmed value. If multiple outputs are controlled by the same FAULT_Cn pin, the decay time of the faulted output determines the retry delay. If the natural decay time of the output is too long, it is possible to remove the voltage requirement of the MFR_RETRY_DELAY command by asserting bit 0 of MFR_CHAN_CONFIG. Alternatively, latched off mode means the controller remains latched-off following a fault and clearing requires user intervention such as toggling RUN_Cn or commanding the part OFF then ON.

LIGHT-LOAD CURRENT OPERATION

The LTM4664 PSM Regulators have two modes of operation: high efficiency discontinuous conduction mode or forced continuous conduction mode. Mode selection is done using the MFR_PWM_MODE command (discontinuous conduction is always the start-up mode, forced continuous is the default running mode).

If a controller is enabled for discontinuous operation, the inductor current is not allowed to reverse. The reverse current comparator's output turns off the bottom MOSFET just before the inductor current reaches zero, preventing it from reversing and going negative.

In forced continuous operation, the inductor current is allowed to reverse at light loads or under large transient conditions. The peak inductor current is determined solely by the voltage on the COMP_Cn pins. In this mode, the efficiency at light loads is lower than in discontinuous mode operation. However, continuous mode exhibits lower output ripple and less interference with audio circuitry, but may result in reverse inductor current, which can cause the input supply to boost. The VIN_OV_FAULT_LIMIT can detect this and turn off the offending channel. However, this fault is based on an ADC read and can take

DUAL 25A PSM OPERATION

up to t_{CONVERT} to detect. If there is a concern about the input supply boosting, keep the part in discontinuous conduction mode.

If the part is set to discontinuous mode operation, as the inductor average current increases, the controller will automatically modify the operation from discontinuous mode to continuous mode.

SWITCHING FREQUENCY AND PHASE

The switching frequency of the PWM_C1 can be established with an internal oscillator or an external time base. The internal phase-locked loop (PLL) synchronizes the PWM control to this timing reference with proper phase relation, whether the clock is provided internally or externally. The device can also be configured to provide the master clock to other devices through PMBus command, NVM setting, or external configuration resistors as outlined in Table 3.

As clock master, a LTM4664 PSM device will drive its open-drain SYNC pin at the selected rate with a pulse width of 500ns. An external pull-up resistor between SYNC and V_{DD33} is required in this case. Only one device connected to SYNC should be designated to drive the pin. The other LTM4664 PSM devices will automatically revert to an external SYNC input, disabling its own SYNC, as long as the external SYNC frequency is greater than 80% of the programmed SYNC frequency. The external SYNC input shall have a duty cycle between 20% and 80%.

Whether configured to drive SYNC or not, the LTM4664 PSM devices can continue PWM operation using its own internal oscillator if an external clock signal is subsequently lost.

The device can also be programmed to always require an external oscillator for PWM operation by setting bit 4 of MFR_CONFIG_ALL. The status of the SYNC driver circuit is indicated by bit 10 of MFR_PADS.

The MFR_PWM_CONFIG command can be used to configure the phase of each channel. Desired phase can also be set from EEPROM or external configuration resistors as outlined in Table 3. Designated phase is the relationship between the falling edge of SYNC and the internal clock

edge that sets the PWM latch to turn on the top power switch. Additional small propagation delays to the PWM control pins will also apply. Both PSM channels must be off before the FREQUENCY_SWITCH and MFR_PWM_CONFIG commands can be written to the LTM4664 PSM.

The phase relationships and frequency options provide for numerous application options. Multiple LTM4664 PSM channels modules can be synchronized to realize a PolyPhase array. In this case the phases should be separated by $360/n$ degrees, where n is the number of phases driving the output voltage rail.

PWM LOOP COMPENSATION

The internal PWM loop compensation resistors $R_{\text{COMP}na}$ of the LTM4664 PSM can be adjusted using bit[4:0] of the MFR_PWM_COMP command.

The transconductance (gm) of the LTM4664 PSM channel PWM error amplifier can be adjusted using bit[7:5] of the MFR_PWM_COMP command. These two loop compensation parameters can be programmed when the device is in operation. Refer to the Programmable Loop Compensation subsection in the Dual 25A PSM Applications Information section for further details.

OUTPUT VOLTAGE SENSING

Both PSM channels in LTM4664 have differential amplifiers, which allow the remote sensing of the load voltage between V^+ and V^- pins. The telemetry ADC is also fully differential and makes measurements between $V_{\text{OSNS}^+_{Cn}}$ and $V_{\text{OSNS}^-_{Cn}}$ voltages for both channels at the V^+ and V^- pins, respectively. The maximum allowed is 1.5V, but the LTM4664 design is limited to 1.8V.

INTV_{CC}/EXTV_{CC} POWER

Power for the internal MOSFET drivers and most other internal circuitry is derived from the INTV_{CC} pin. When the EXTV_{CC} pin is shorted to GND or tied to a voltage less than 4.7V, an internal 5.5V linear regulator supplies INTV_{CC} power from V_{INS3} . If EXTV_{CC} is taken above approximately 4.7V and V_{INS3_C1} is higher than 7.0V, the 5.5V regulator is turned off and an internal switch is turned on,

DUAL 25A PSM OPERATION

connecting $EXTV_{CC}$ to $INTV_{CC}$. Using the $EXTV_{CC}$ allows the $INTV_{CC}$ power to be derived from a high efficiency external source such as a switching regulator output. $EXTV_{CC}$ can provide power to the internal 3.3V linear regulator even when V_{INS3} is not present, which allows the LTM4664 PSM to be initialized and programmed even without main power being applied.

The $INTV_{CC}$ regulator is powered from the V_{INS3_C1} pin, the power through the IC is equal to $V_{INS3_C1} \cdot I_{INTVCC}$. The gate charge current is dependent on operating frequency. The $INTV_{CC}$ regulator can supply up to 100mA, and the typical $INTV_{CC}$ current for the LTM4664 PSM is ~50mA. A 12V input voltage would equate to a difference of 7V drop across the internal controller, when multiplied by 50mA equals a 350mW power loss. This loss can be eliminated by providing an external 5V bias on the $EXTV_{CC}$ pin.

Do not tie $INTV_{CC}$ on the LTM4664 PSM to an external supply because $INTV_{CC}$ will attempt to pull the external supply high and hit current limit, significantly increasing the die temperature.

OUTPUT CURRENT SENSING AND SUB MILLIOHM DCR CURRENT SENSING

The LTM4664 PSM channels use a unique sub-milliohm inductor current sensing technique that provides a high level signal to noise ratio while sensing very low signals in current mode operation. This enables higher conversion efficiencies with the use of the internal sub-milliohm inductors in heavy load applications. The current limit threshold can be accurately set with the $MFR_PWM_MODE[7]$ for high and low range. The low range setting $MFR_PWM_MODE [7] = 0$ should be used (see page103).

The internal DCR sensing network, thus current limit are calculated based on the DCR of the inductor at room temperature. The DCR of the inductor has a large temperature coefficient, approximately 3900ppm/°C. The temperature coefficient of the inductor is written to the $MFR_IOUT_CAL_GAIN_TC$ register. The external temperature is sensed near the inductor and used to modify the internal current limit circuit to maintain an essentially constant current limit with temperature. The current sensed is then digitized by the LTM4664 PSM telemetry ADC with

an input range of $\pm 128mV$, a noise floor of $7\mu V_{RMS}$, and a peak-peak noise of approximately 46.5 μV . The LTM4664 PSM computes the inductor current using the DCR value stored in the $IOUT_CAL_GAIN$ command and the temperature coefficient stored in command $MFR_IOUT_CAL_GAIN_TC$. The resulting current value is returned by the $READ_IOUT$ command.

INPUT CURRENT SENSING

To sense total input current consumed by the LTM4664's 25A two power stages, a sense resistor is placed between the supply voltage and V_{INS3} path. The I_{IN}^+ and I_{IN}^- pins are connected to the sense resistor. The filtered voltage is amplified by the internal high side current sense amplifier and digitized by the LTM4664's PSM telemetry ADC. The input current sense amplifier has three gain settings of 2x, 4x, and 8x set by the bit[6:5] of the MFR_PWM_CONFIG command. The maximum input sense voltage for the three gain settings is 50mV, 20mV, and 5mV respectively. The LTM4664 PSM computes the input current using the internal R_{SENSE} value stored in the IIN_CAL_GAIN command. The resulting measured power stage current is returned by the $READ_IIN$ command.

The LTM4664 uses a 1 Ω resistor to measure the chip supply current being consumed by the LTM4664 PSM Controller. This value is returned by the MFR_READ_ICHIP command. The chip current is calculated by using the 1 Ω value stored in the MFR_RVIN command. Refer to the subsection titled Input Current Sense Amplifier in the Dual 25A PSM Applications Information section for further details.

PolyPhase LOAD SHARING

Multiple LTM4664s can be arrayed in order to provide a balanced load-share solution by bussing the necessary pins. Figure 48 illustrates a 4-Phase design sharing connections required for load sharing.

If an external oscillator is not provided, the SYNC pin should only be enabled on one of the LTM4664's PSM Channels. The other(s) should be programmed to disable SYNC using bit 4 of MFR_CONFIG_ALL . If an external oscillator is present, the chip with the SYNC

DUAL 25A PSM OPERATION

pin enabled will detect the presence of the external clock and disable its output.

Multiple channels need to tie all the $V_{OSNS}^+ Cn$ pins together, and all the $V_{OSNS}^- Cn$ pins together, $\overline{C}_{OMP} na$ and $C_{OMP} nb$ pins together as well. Do not assert bit[4] of MFR_CONFIG_ALL except in a PolyPhase application.

The user must share the SYNC, SHARE_CLK, $\overline{FAULT} Cn$, and \overline{ALERT} pins of these parts. Be sure to use pull-up resistors on SYNC, $\overline{FAULT} Cn$, SHARE_CLK and \overline{ALERT} .

EXTERNAL/INTERNAL TEMPERATURE SENSE

Temperature is measured using the internal diode-connected PNP transistors on either of the TSNS_C0b or TSNS_C1b pins corresponding to channel 0 or 1. TSNS_Cnb pins should be connected to their respective TSNS_Cna pins, and these returns are directly connected to the LTM4664 PSM SGND_CO_C1 pin. Two different currents are applied to the diode (nominally 2 μ A and 32 μ A) and the temperature is calculated from a ΔV_{BE} measurement made with the internal 16-bit monitor ADC (see Figure 2, Block Diagram).

The LTM4664 PSM channels will only implement ΔV_{BE} temperature sensing, therefore MFR_PWM_MODE bit[5] is reserved.

RCONFIG (RESISTOR CONFIGURATION) PINS

There are six input pins utilizing 1% resistors for these pins to select key operating parameters. The pins are ASEL, FSWPH_CFG, VOUTC0_CFG, VOUTC1_CFG, VTRIMC0_CFG, VTRIMC1_CFG. If pins are floated, the value stored in the corresponding NVM command is used. If bit 6 of the MFR_CONFIG_ALL configuration command is asserted in NVM, the resistor input is ignored upon power-up except for ASEL which is always respected. The resistor configuration pins are only measured during a power-up reset or after a MFR_RESET or after a RESTORE_USER_ALL command is executed.

The VOUT n _CFG pin settings are described in Table 1. These pins set the LTM4664 V_{OUTC0} and V_{OUTC1} output voltage coarse settings. If the pin is open, the VOUT_COMMAND command is loaded from NVM to determine the output voltage. The default setting is to have the

switcher off unless the voltage configuration pins are installed. The VTRIM n _CFG pins in Table 2 are used to set the output voltage fine adjustment setting. Both combine to offer several distinct output voltages.

The following parameters are set as a percentage of the output voltage if the RCONFIG pins are used to determine the output voltage:

- VOUT_OV_FAULT_LIMIT+10%
- VOUT_OV_WARN_LIMIT+7.5%
- VOUT_MAX+7.5%
- VOUT_MARGIN_HIGH+5%
- VOUT_MARGIN_LOW-5%
- VOUT_UV_FAULT_LIMIT-7%

The FSWPH_CFG pin settings are described in Table 3. This pin selects the switching frequency and phase of each channel. The phase relationships between the two channels and SYNC pin are determined in Table 3. To synchronize to an external clock, the part should be put into external clock mode (SYNC output disabled but frequency set to the nominal value). If no external clock is supplied, the part will clock at the programmed frequency. If the application is multiphase and the SYNC signal between chips is lost, the parts will not operate at the designed phase even if they are programmed and trimmed to the same frequency.

This may increase the ripple voltage on the output, possibly produce undesirable operation. If the external SYNC signal is being generated internally and external SYNC is not selected, bit 10 of MFR_PADS will be asserted. If no frequency is selected and the external SYNC frequency is not present, a PLL_FAULT will occur. If the user does not wish to see the \overline{ALERT} from a PLL_FAULT even if there is not a valid synchronization signal at power-up, the \overline{ALERT} mask for PLL_FAULT must be written. See the description on SMBALERT_MASK for more details. If the SYNC pin is connected between multiple ICs only one of the ICs should have the SYNC pin enabled using the MFR_CONFIG_ALL[4] =1, and all other ICs should be configured to have the SYNC pin disabled with MFR_CONFIG_ALL[4] =0.

The ASEL pin settings are described in Table 4. ASEL selects slave address for the LTM4664 PSM. For more detail, refer to Table 5.

DUAL 25A PSM OPERATION

NOTE: Per the PMBus specification, pin programmed parameters can be overridden by commands from the digital interface with the exception of ASEL which is always honored. Do not set any part address to 0x5A or 0x5B because these are global addresses and all parts will respond to them.

Table 1. VOUTC_n_CFG Pin Strapping Look-Up Table for the LTM4664's PSM Output Voltages, Coarse Setting (Not Applicable if MFR_CONFIG_ALL[6] = 1b)

R _{VOUTC_n_CFG TOP} (kΩ)	R _{VOUTC_n_CFG BOT} (kΩ)	V _{OUTC_n} (V) SETTING COARSE	MFR_PWM MODE _n [1] BIT
14.3	Open	NVM	NVM
14.3	32.4	NVM	NVM
14.3	22.6	3.3	0
14.3	18.0	3.1	0
14.3	15.4	2.9	0
14.3	12.7	2.7	0
14.3	10.7	2.5	0, if V _{TRIMn} > 0mV 1, if V _{TRIMn} ≤ 0mV
14.3	9.09	2.3	1
14.3	7.68	2.1	1
14.3	6.34	1.9	1
14.3	5.23	1.7	1
14.3	4.22	1.5	1
14.3	3.24	1.3	1
14.3	2.43	1.1	1
14.3	1.65	0.9	1
14.3	0.787	0.7	1
14.3	0	0.5	1

*R_{VOUTC_n_CFG} value indicated is nominal. Select R_{VOUTC_n_CFG} from a resistor vendor such that its value is always within 3% of the value indicated in the table. Take into account resistor initial tolerance, T.C.R. and resistor operating temperatures, soldering heat/IR reflow, and endurance of the resistor over its lifetime. Thermal shock/cycling, moisture (humidity) and other effects (depending on one's specific application) could also affect R_{VOUTC_n_CFG}'s value over time. All such effects must be taken into account in order for resistor pin strapping to yield the expected result at every SV_{IN} power-up and/or every execution of MFR_RESET or RESTORE_USER_ALL, over the lifetime of one's product.

Table 2. VTRIM_n_CFG Pin Strapping Look-Up Table for the LTM4664's PSM Output Voltages, Fine Adjustment Setting (Not Applicable if MFR_CONFIG_ALL[6] = 1b)

R _{VTRIM_n_CFG BOT} (kΩ)	V _{TRIM} (mV) FINE ADJUSTMENT TO V _{OUTC_n} SETTING WHEN RESPECTIVE	R _{VTRIM_n_CFG TOP} (kΩ)
Open	0	14.3
32.4	99	14.3
22.6	86.625	14.3
18.0	74.25	14.3
15.4	61.875	14.3
12.7	49.5	14.3
10.7	37.125	14.3
9.09	24.75	14.3
7.68	12.375	14.3
6.34	-12.375	14.3
5.23	-24.75	14.3
4.22	-37.125	14.3
3.24	-49.5	14.3
2.43	-61.875	14.3
1.65	-74.25	14.3
0.787	-86.625	14.3
0	-99	14.3

*R_{VTRIMC_n_CFG} value indicated is nominal. Select R_{VTRIMC_n_CFG} from a resistor vendor such that its value is always within 3% of the value indicated in the table. Take into account resistor initial tolerance, T.C.R. and resistor operating temperatures, soldering heat/IR reflow, and endurance of the resistor over its lifetime. Thermal shock/cycling, moisture (humidity) and other effects (depending on one's specific application) could also affect R_{VTRIMC_n_CFG}'s value over time. All such effects must be taken into account in order for resistor pin strapping to yield the expected result at every SV_{IN} power-up and/or every execution of MFR_RESET, or RESTORE_USER_ALL over the lifetime of one's product.

Example:

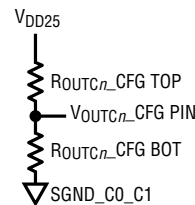

DUAL 25A PSM OPERATION

Table 3. FSWPH_CFG Pin Strapping Look-Up Table to Set the LTM4664's PSM Switching Frequency and Channel Phase-Interleaving Angle (Not Applicable if MFR_CONFIG_ALL[6] = 1b)

R _{FSWPH_CFG TOP} (kΩ)	R _{FSWPH_CFG BOT} * (kΩ)	SWITCHING FREQUENCY (kHz)	θ _{SYNC TO θ0}	θ _{SYNC TO θ1}	bits [2:0] of MFR_PWM_CONFIG	bit [4] of MFR_CONFIG_ALL
14.3	Open	NVM; LTM4664 PSM Default = 500	NVM; LTM4664 Default = 0°	NVM; LTM4664 PSM Default = 180°	NVM; LTM4664 PSM Default = 000b	NVM; LTM4664 PSM Default = 0b
14.3	32.4	250	0°	180°	000b	0b
14.3	22.6	350	0°	180°	000b	0b
14.3	18.0	425	0°	180°	000b	0b
14.3	15.4	575	0°	180°	000b	0b
14.3	12.7	650	0°	180°	000b	0b
14.3	10.7	750	0°	180°	000b	0b
14.3	7.68	500	120°	240°	100b	0b
14.3	6.34	500	90°	270°	001b	0b
14.3	5.23	External**	0°	240°	010b	1b
14.3	4.22	External**	0°	120°	011b	1b
14.3	3.24	External**	60°	240°	101b	1b
14.3	2.43	External**	120°	300°	110b	1b
14.3	1.65	External**	90°	270°	001b	1b
14.3	0.787	External**	0°	180°	000b	1b
14.3	0	External**	120°	240°	100b	1b

*R_{FSWPH_CFG} value indicated is nominal. Select R_{FSWPH_CFG} from a resistor vendor such that its value is always within 3% of the value indicated in the table. Take into account resistor initial tolerance, T.C.R. and resistor operating temperatures, soldering heat/IR reflow, and endurance of the resistor over its lifetime. Thermal shock/cycling, moisture (humidity) and other effects (depending on one's specific application) could also affect R_{FSWPH_CFG}'s value over time. All such effects must be taken into account in order for resistor pin-strapping to yield the expected result at every SV_{IN} power-up and/or every execution of MFR_RESET or RESTORE_USER_ALL, over the lifetime of one's product.

**External setting corresponds to FREQUENCY_SWITCH (Register 0x33) value set to 0x0000; the device synchronizes its switching frequency to that of the clock provided on the SYNC pin, provided MFR_CONFIG_ALL[4] = 1b.

Example:

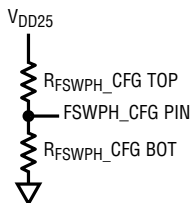

DUAL 25A PSM OPERATION

Table 4. ASEL Pin Strapping Look-Up Table to Set the LTM4664's PSM Slave Address (Applicable Regardless of MFR_CONFIG_ALL[6] Setting)

R _{ASEL} * (kΩ)	SLAVE ADDRESS
Open	100_1111_R/W
32.4	100_1111_R/W
22.6	100_1110_R/W
18.0	100_1101_R/W
15.4	100_1100_R/W
12.7	100_1011_R/W
10.7	100_1010_R/W
9.09	100_1001_R/W
7.68	100_1000_R/W
6.34	100_0111_R/W
5.23	100_0110_R/W
4.22	100_0101_R/W
3.24	100_0100_R/W
2.43	100_0011_R/W
1.65	100_0010_R/W
0.787	100_0001_R/W
0	100_0000_R/W

Where:

R/W = Read/Write bit in control byte

All PMBus device addresses listed in the specification are 7 bits wide unless otherwise noted.

Note: The LTM4664 PSM will always respond to slave address 0x5A and 0x5B regardless of the NVM or ASEL resistor configuration values.

*R_{CFG} value indicated is nominal. Select R_{CFG} from a resistor vendor such that its value is always within 3% of the value indicated in the table. Take into account resistor initial tolerance, T.C.R. and resistor operating temperatures, soldering heat/IR reflow, and endurance of the resistor over its lifetime. Thermal shock cycling, moisture (humidity) and other effects (depending on one's specific application) could also affect R_{CFG}'s value over time. All such effects must be taken into account in order for resistor pin-strapping to yield the expected result at every SV_{IN} power-up and/or every execution of MFR_RESET or RESTORE_USER_ALL, over the lifetime of one's product.

Example:

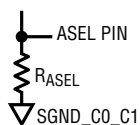

Table 5. LTM4664 PSM MFR_ADDRESS Command Examples Expressed in 7- and 8-Bit Addressing

DESCRIPTION	HEX DEVICE ADDRESS		BIT								
	7-BIT	8-BIT	7	6	5	4	3	2	1	0	R/W
Rail ⁴	0x5A	0xB4	0	1	0	1	1	0	1	0	0
Global ⁴	0x5B	0xB6	0	1	0	1	1	0	1	1	0
Default	0x4F	0x9E	0	1	0	0	1	1	1	1	0
Example 1	0x40	0x80	0	1	0	0	0	0	0	0	0
Example 2	0x41	0x82	0	1	0	0	0	0	0	1	0
Disabled ^{2,3}			1	0	0	0	0	0	0	0	0

Note 1: This table can be applied to the MFR_RAIL_ADDRESS_n commands, but not the MFR_ADDRESS command.

Note 2: A disabled value in one command does not disable the device, nor does it disable the global address.

Note 3: A disabled value in one command does not inhibit the device from responding to device addresses specified in other commands.

Note 4: It is not recommended to write the value 0x00, 0x0C (7-bit), 0x5A (7-bit), 0x5B (7-bit) or 0x7C(7-bit) to the MFR_CHANNEL_ADDRESS_n or the MFR_RAIL_ADDRESS_n commands.

FAULT DETECTION AND HANDLING

A variety of fault and warning reporting and handling mechanisms are available. Fault and warning detection capabilities include:

- Input OV $\overline{\text{FAULT}}$ Protection and UV Warning
- Average Input OC Warn
- Output OV/UV Fault and Warn Protection
- Output OC Fault and Warn Protection
- Internal control Die and Internal Module Overtemperature Fault and Warn Protection
- Internal Undertemperature Fault and Warn Protection
- CML Fault (Communication, Memory or Logic)
- External Fault Detection via the Bidirectional $\overline{\text{FAULT}}_Cn$ Pins

In addition, the LTM4664 PSM can map any combination of fault indicators to their respective $\overline{\text{FAULT}}_Cn$ pin using the propagate $\overline{\text{FAULT}}_n$ response commands, MFR_FAULT_PROPAGATE. Typical usage of a $\overline{\text{FAULT}}_Cn$ pin is as a driver for an external crowbar device, overtemperature alert, overvoltage alert or as an interrupt to cause a

DUAL 25A PSM OPERATION

microcontroller to poll the fault commands. Alternatively, the $\overline{\text{FAULT_Cn}}$ pins can be used as inputs to detect external faults downstream of the controller that require an immediate response.

Any fault or warning event will always cause the $\overline{\text{ALERT}}$ pin to assert low unless the fault or warning is masked by the SMBALERT_MASK . The pin will remain asserted low until the CLEAR_FAULTS command is issued, the fault bit is written to a 1 or bias power is cycled or a MFR_RESET command is issued, or the RUN pins are toggled OFF/ON or the part is commanded OFF/ON via PMBus or an ARA command operation is performed. The $\text{MFR_FAULT_PROPAGATE}$ command determines if the FAULT_Cn pins are pulled low when a fault is detected.

Output and input fault event handling is controlled by the corresponding fault response byte as specified in Table 3 thru 17. Shutdown recovery from these types of faults can either be autonomous or latched. For autonomous recovery, the faults are not latched, so if the fault conditions not present after the retry interval has elapsed, a new soft-start is attempted.

If the fault persists, the controller will continue to retry. The retry interval is specified by the MFR_RETRY_DELAY command and prevents damage to the regulator components by repetitive power cycling, assuming the fault condition itself is not immediately destructive. The MFR_RETRY_DELAY must be greater than 120ms. It can not exceed 83.88 seconds.

Status Registers and $\overline{\text{ALERT}}$ Masking

Figure 9 summarizes the internal LTM4664 PSM status registers accessible by PMBus command. These contain indication of various faults, warnings and other important operating conditions. As shown, the STATUS_BYTE and STATUS_WORD commands also summarize contents of other status registers. Refer to PMBus Command Summary for specific information.

NONE OF THE ABOVE in the STATUS_BYTE indicates that one or more of the bits in the most-significant nibble of STATUS_WORD are also set.

In general, any asserted bit in a STATUS_x register also pulls the $\overline{\text{ALERT}}$ pin low. Once set, $\overline{\text{ALERT}}$ will remain low until one of the following occurs.

- A CLEAR_FAULTS or MFR_RESET Command Is Issued
- The Related Status Bit Is Written to a One
- The Faulted Channel Is Properly Commanded Off and Back On
- The LTM4664 PSM Successfully Transmits Its Address During a PMBus ARA
- Bias Power Is Cycled

With some exceptions, the SMBALERT_MASK command can be used to prevent the LTM4664 PSM from asserting $\overline{\text{ALERT}}$ for bits in these registers on a bit-by-bit basis. These mask settings are promoted to STATUS_WORD and STATUS_BYTE in the same fashion as the status bits themselves. For example, if $\overline{\text{ALERT}}$ is masked for all bits in channel 0 STATUS_VOUT , then $\overline{\text{ALERT}}$ is effectively masked for the V_{OUT} bit in STATUS_WORD for PAGE 0. The BUSY bit in STATUS_BYTE also asserts $\overline{\text{ALERT}}$ low and cannot be masked. This bit can be set as a result of various internal interactions with PMBus communication. This fault occurs when a command is received that cannot be safely executed with one or both channels enabled. As discussed in the 4:1 Divider Application Information, BUSY faults can be avoided by polling MFR_COMMON before executing some commands.

If masked faults occur immediately after power up, $\overline{\text{ALERT}}$ may still be pulled low because there has not been time to retrieve all of the programmed masking information from EEPROM.

Status information contained in MFR_COMMON and MFR_PADS can be used to further debug or clarify the contents of STATUS_BYTE or STATUS_WORD as shown, but the contents of these registers do not affect the state of the $\overline{\text{ALERT}}$ pin and may not directly influence bits in STATUS_BYTE or STATUS_WORD .

DUAL 25A PSM OPERATION

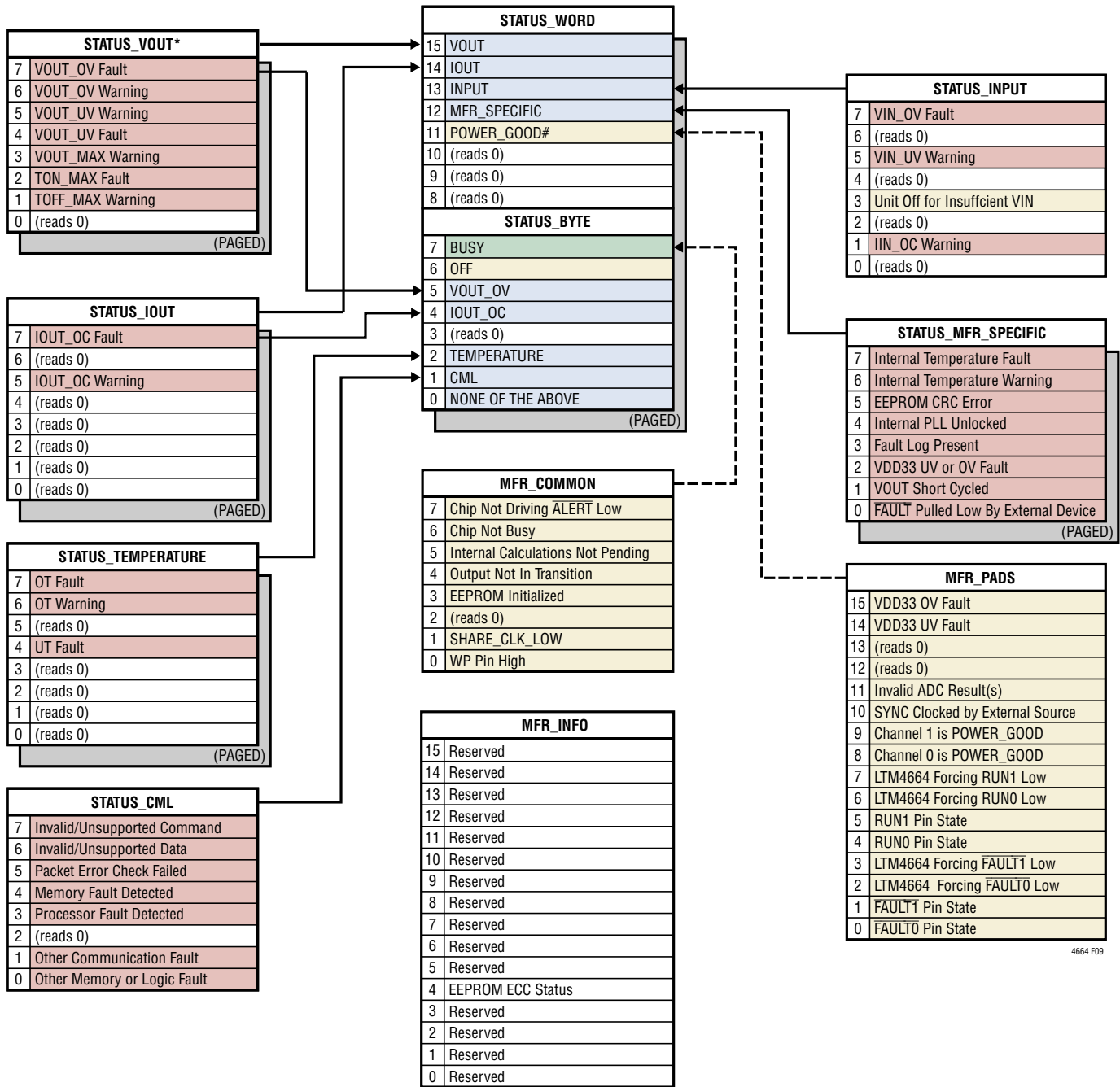

4664 F09

DESCRIPTION	MASKABLE	GENERATES ALERT	BIT CLEARABLE
General Fault or Warning Event	Yes	Yes	Yes
General Non-Maskable Event	No	Yes	Yes
Dynamic	No	No	No
Status Derived from Other Bits	No	Not Directly	No

Figure 9. LTM4664 PSM Status Register Summary

DUAL 25A PSM OPERATION

Mapping Faults to $\overline{\text{FAULT}}$ Pins

Channel-to-channel fault (including channels from multiple LTM4664 PSMs) dependencies can be created by connecting $\overline{\text{FAULT}}_{Cn}$ pins together. In the event of an internal fault, one or more of the channels is configured to pull the bussed $\overline{\text{FAULT}}_{Cn}$ pins low. The other channels are then configured to shut down when the $\overline{\text{FAULT}}_{Cn}$ pins are pulled low. For autonomous group retry, the faulted channel is configured to let go of the $\overline{\text{FAULT}}_{Cn}$ pin(s) after a retry interval, assuming the original fault has cleared. All the channels in the group then begin a soft-start sequence. If the fault response is LATCH_OFF, the $\overline{\text{FAULT}}_{Cn}$ pin remains asserted low until either the RUN_{Cn} pin is toggled OFF/ON or the part is commanded OFF/ON. The toggling of the RUN_{Cn} either by the pin or OFF/ON command will clear faults associated with the channel. If it is desired to have all faults cleared when either RUN_{Cn} pin is toggled or, set bit 0 of MFR_CONFIG_ALL to a 1.

The status of all faults and warnings is summarized in the STATUS_WORD and STATUS_BYTE commands.

Additional fault detection and handling capabilities are: See Table 18.

Power Good Pins

The PGOOD_{Cn} pins of the LTM4664 PSM are connected to the open drains of internal MOSFETs. The MOSFETs turn on and pull the PGOOD_{Cn} pins low when the channel output voltage is not within the channel's UV and OV voltage thresholds. During TON_DELAY and TON_RISE sequencing, the PGOOD_{Cn} pin is held low. The PGOOD_{Cn} pin is also pulled low when the respective RUN_{Cn} pin is low. The PGOOD_{Cn} pin response is deglitched by an internal 100 μs digital filter. The PGOOD_{Cn} pin and PGOOD status may be different at times due to communication latency of up to 10 μs .

CRC Protection

The integrity of the NVM memory is checked after a power on reset. A CRC error will prevent the controller from leaving the inactive state. If a CRC error occurs, the CML bit is set in the STATUS_BYTE and STATUS_WORD commands, the appropriate bit is set in the $\text{STATUS_MFR_SPECIFIC}$

command, and the $\overline{\text{ALERT}}$ pin will be pulled low. NVM repair can be attempted by writing the desired configuration to the controller and executing a STORE_USER_ALL command followed by a CLEAR_FAULTS command.

The LTM4664 manufacturing section of the NVM is mirrored. If both copies are corrupted, the "NVM CRC Fault" in the $\text{STATUS_MFR_SPECIFIC}$ command is set. If this bit remains set after being cleared by issuing a CLEAR_FAULTS or writing a 1 to this bit, an irrecoverable internal fault has occurred. The user is cautioned to disable both output power supply rails associated with this specific part. There are no provisions for field repair of NVM faults in the manufacturing section.

SERIAL INTERFACE

The LTM4664 serial interface is a PMBus compliant slave device and can operate at any frequency between 10kHz and 400kHz. The address is configurable using either the NVM or an external resistor divider. In addition the LTM4664 always responds to the global broadcast address of 0x5A (7-bit) or 0x5B (7-bit).

The serial interface supports the following protocols defined in the PMBus specifications: 1) send command, 2) write byte, 3) write word, 4) group, 5) read byte, 6) read word and 7) read block. 8) write block. All read operations will return a valid PEC if the PMBus master requests it. If the PEC_REQUIRED bit is set in the MFR_CONFIG_ALL command, the PMBus write operations will not be acted upon until a valid PEC has been received by the LTM4664.

Communication Protection

PEC write errors (if PEC_REQUIRED is active), attempts to access unsupported commands, or writing invalid data to supported commands will result in a CML fault. The CML bit is set in the STATUS_BYTE and STATUS_WORD commands, the appropriate bit is set in the STATUS_CML command, and the $\overline{\text{ALERT}}$ pin is pulled low.

DEVICE ADDRESSING

The LTM4664 PSM offers four different types of addressing over the PMBus interface, specifically: 1) global, 2) device, 3) rail addressing and 4) alert response address (ARA).

DUAL 25A PSM OPERATION

Global addressing provides a means of the PMBus master to address all LTM4664 PSM devices on the bus. The LTM4664 PSM global address is fixed 0x5A (7-bit) or 0xB4 (8-bit) and cannot be disabled. Commands sent to the global address act the same as if PAGE is set to a value of 0xFF. Commands sent are written to both channels simultaneously. Global command 0x5B (7-bit) or 0xB6 (8-bit) is paged and allows channel specific command of all LTM4664 PSM devices on the bus. Other ADI device types may respond at one or both of these global addresses. Reading from global addresses is strongly discouraged.

Device addressing provides the standard means of the PMBus master communicating with a single instance of an LTM4664 PSM. The value of the device address is set by a combination of the ASEL configuration pin and the MFR_ADDRESS command. When this addressing means is used, the PAGE command determines the channel being acted upon. Device addressing can be disabled by writing a value of 0x80 to the MFR_ADDRESS.

Rail addressing provides a means for the bus master to simultaneously communicate with all channels connected together to produce a single output voltage (PolyPhase). While similar to global addressing, the rail address can be dynamically assigned with the paged MFR_RAIL_ADDRESS command, allowing for any logical grouping of channels that might be required for reliable system control. Reading from rail addresses is also strongly discouraged.

All four means of PMBus addressing require the user to employ disciplined planning to avoid addressing conflicts. Communication to LTM4664 PSM devices at global and rail addresses should be limited to command write operations.

RESPONSES TO V_{OUT} AND I_{IN}/I_{OUT} FAULTS

V_{OUT} OV and UV conditions are monitored by comparators. The OV and UV limits are set in three ways:

- As a Percentage of the V_{OUT} if Using the Resistor Configuration Pins
- In NVM if Either Programmed at the Factory or Through the GUI
- By PMBus Command

The I_{IN} and I_{OUT} overcurrent monitors are performed by ADC readings and calculations. Thus these values are based on average currents and can have a time latency of up to $t_{CONVERT}$. The I_{OUT} calculation accounts for the DCR and their temperature coefficient. The input current is equal to the voltage measured across the R_{SENSE} resistor divided by the resistors value as set with the MFR_RVIN command. If this calculated input current exceeds the $I_{IN_OC_WARN_LIMIT}$ the \overline{ALERT} pin is pulled low and the $I_{IN_OC_WARN}$ bit is asserted in the STATUS_INPUT command.

The digital processor within the LTM4664 PSM provides the ability to ignore the fault, shut down and latch off or shut down and retry indefinitely (hiccup). The retry interval is set in MFR_RETRY_DELAY and can be from 120ms to 83.88 seconds in 1ms increments. The shutdown for OV/UV and OC can be done immediately or after a user selectable deglitch time.

Output Overvoltage Fault Response

A programmable overvoltage comparator (OV) guards against transient overshoots as well as long-term overvoltages at the output. In such cases, the top MOSFET is turned off and the bottom MOSFET is turned on. However, the reverse output current is monitored while device is in OV fault. When it reaches the limit, both top and bottom MOSFETs are turned off. The top and bottom MOSFETs will keep their state until the overvoltage condition is cleared regardless of the PMBus $V_{OUT_OV_FAULT_RESPONSE}$ command byte value. This hardware level fault response delay is typically $2\mu s$ from the overvoltage condition to BG asserted high. Using the $V_{OUT_OV_FAULT_RESPONSE}$ command, the user can select any of the following behaviors:

- OV Pull-Down Only (OV Cannot Be Ignored)
- Shut Down (Stop Switching) Immediately—Latch Off
- Shut Down Immediately—Retry Indefinitely at the Time Interval Specified in MFR_RETRY_DELAY

Either the Latch Off or Retry fault responses can be deglitched in increments of (0-7) • $10\mu s$. See Table 14.

DUAL 25A PSM OPERATION

Output Undervoltage Response

The response to an undervoltage comparator output can be the following:

- Ignore
- Shut Down Immediately—Latch Off
- Shut Down Immediately—Retry Indefinitely at the Time Interval Specified in MFR_RETRY_DELAY.

The UV responses can be deglitched. See Table 14.

Peak Output Overcurrent Fault Response

Due to the current mode control algorithm, peak output current across the inductor is always limited on a cycle-by-cycle basis. The value of the peak current limit is specified in Electrical Characteristics table. The current limit circuit operates by limiting the COMP_Cn maximum voltage. Since internal DCR sensing is used, the COMP_Cn maximum voltage has a temperature dependency directly proportional to the TC of the DCR of the inductor. The LTM4664 PSM automatically monitors the external temperature sensors and modifies the maximum allowed COMP_Cn to compensate for this term. The IOUT_OC_FAULT_LIMIT section provides data points for IOUT Limiting on page103.

The overcurrent fault processing circuitry can execute the following behaviors:

- Current Limit Indefinitely
- Shut Down Immediately—Latch Off
- Shut Down Immediately—Retry Indefinitely at the Time Interval Specified in MFR_RETRY_DELAY.

The overcurrent responses can be deglitched in increments of (0-7) • 16ms. See Table 15.

RESPONSES TO TIMING FAULTS

TON_MAX_FAULT_LIMIT is the time allowed for V_{OUT} to rise and settle at start-up. The TON_MAX_FAULT_LIMIT condition is predicated upon detection of the VOUT_UV_FAULT_LIMIT as the output is undergoing a SOFT_START sequence. The TON_MAX_FAULT_LIMIT time is started after TON_DELAY has been reached and a SOFT_START

sequence is started. The resolution of the TON_MAX_FAULT_LIMIT is 10μs. If the VOUT_UV_FAULT_LIMIT is not reached within the TON_MAX_FAULT_LIMIT time, the response of this fault is determined by the value of the TON_MAX_FAULT_RESPONSE command value. This response may be one of the following:

- Ignore
- Shut Down (Stop Switching) Immediately—Latch Off
- Shut Down Immediately—Retry Indefinitely at the Time Interval Specified in MFR_RETRY_DELAY.

This fault response is not deglitched. A value of 0 in TON_MAX_FAULT_LIMIT means the fault is ignored. The TON_MAX_FAULT_LIMIT should be set longer than the TON_RISE time. It is recommended TON_MAX_FAULT_LIMIT always be set to a non-zero value, otherwise the output may never come up and no flag will be set to the user. See Table 16.

RESPONSES TO V_{IN} OV FAULTS

V_{IN} overvoltage is measured with the ADC. The response is naturally deglitched by the 100ms typical response time of the ADC. The fault responses are:

- Ignore
- Shut Down Immediately—Latch Off
- Shut Down Immediately—Retry Indefinitely at the Time Interval Specified in MFR_RETRY_DELAY. See Table 16.

RESPONSES TO OT/UT FAULTS

Internal Overtemperature Fault Response

An internal temperature sensor protects against NVM damage. Above 85°C, no writes to NVM are recommended. Above 130°C, the internal overtemperature warn threshold is exceeded and the part disables the NVM and does not reenables until the temperature has dropped to 125°C. When the die temperature exceed 160°C the internal temperature fault response is enabled and the PWM is disabled until the die temperature drops below 150°C. Temperature is measured by the ADC. Internal

DUAL 25A PSM OPERATION

temperature faults cannot be ignored. Internal temperature limits cannot be adjusted by the user. See Table 14.

External Overtemperature and Undertemperature Fault Response

Two internal temperature sensors are used to sense the temperature of critical circuit elements like inductors and power MOSFETs on each channel. The OT_FAULT_RESPONSE and UT_FAULT_RESPONSE commands are used to determine the appropriate response to an overtemperature and under temperature condition, respectively. If no external sense elements are used (not recommended) set the UT_FAULT_RESPONSE to ignore—and set the UT_FAULT_LIMIT to 275°C. The fault responses are:

- Ignore
- Shut Down Immediately—Latch Off
- Shut Down Immediately—Retry Indefinitely at the Time Interval Specified in MFR_RETRY_DELAY. See Table 16.

RESPONSES TO INPUT OVERCURRENT AND OUTPUT UNDERCURRENT FAULTS

Input overcurrent and output undercurrent are measured with the ADC. The fault responses are:

- Ignore
- Shut Down Immediately—Latch Off
- Shut Down Immediately—Retry Indefinitely at the Time Interval Specified in MFR_RETRY_DELAY. See Table 15.

RESPONSES TO EXTERNAL FAULTS

When either $\overline{\text{FAULT}}_Cn$ pin is pulled low, the OTHER bit is set in the STATUS_WORD command, the appropriate bit is set in the STATUS_MFR_SPECIFIC command, and the $\overline{\text{ALERT}}$ pin is pulled low. Responses are not deglitched. Each channel can be configured to ignore or shut down then retry in response to its $\overline{\text{FAULT}}_Cn$ pin going low by modifying the MFR_FAULT_RESPONSE command. To avoid the $\overline{\text{ALERT}}$ pin asserting low when $\overline{\text{FAULT}}_Cn$ is pulled low, assert bit 1 of MFR_CHAN_CONFIG, or mask the ALERT using the SMBALERT_MASK command.

FAULT LOGGING

The LTM4664 PSM has fault logging capability. Data is logged into memory in the order shown in Table 19. The data is stored in a continuously updated buffer in RAM. When a fault event occurs, the fault log buffer is copied from the RAM buffer into NVM. Fault logging is allowed at temperatures above 85°C; however, retention of 10 years is not guaranteed. When the die temperature exceeds 130°C the fault logging is delayed until the die temperature drops below 125°C. The fault log data remains in NVM until a MFR_FAULT_LOG_CLEAR command is issued. Issuing this command reenables the fault log feature. Before reenabling fault log, be sure no faults are present and a CLEAR_FAULTS command has been issued.

When the LTM4664 PSM powers-up or exits its reset state, it checks the NVM for a valid fault log. If a valid fault log exists in NVM, the “Valid Fault Log” bit in the STATUS_MFR_SPECIFIC command will be set and an $\overline{\text{ALERT}}$ event will be generated. Also, fault logging will be blocked until the LTM4664 PSM has received a MFR_FAULT_LOG_CLEAR command before fault logging will be reenabled.

The information is stored in EEPROM in the event of any fault that disables the controller on either channel. A $\overline{\text{FAULT}}_Cn$ being externally pulled low will not trigger a fault logging event.

BUS TIMEOUT PROTECTION

The LTM4664 PSM implements a timeout feature to avoid persistent faults on the serial interface. The data packet timer begins at the first START event before the device address write byte. Data packet information must be completed within 30ms or the LTM4664 PSM will three-state the bus and ignore the given data packet. If more time is required, assert bit 3 of MFR_CONFIG_ALL to allow typical bus timeouts of 255ms. Data packet information includes the device address byte write, command byte, repeat start event (if a read operation), device address byte read (if a read operation), all data bytes and the PEC byte if applicable.

The LTM4664 PSM allows longer PMBus timeouts for block read data packets. This timeout is proportional to the length of the block read. The additional block read

DUAL 25A PSM OPERATION

timeout applies primarily to the MFR_FAULT_LOG command. The timeout period defaults to 32ms.

The user is encouraged to use as high a clock rate as possible to maintain efficient data packet transfer between all devices sharing the serial bus interface. The LTM4664 PSM supports the full PMBus frequency range from 10kHz to 400kHz.

SIMILARITY BETWEEN PMBus, SMBus AND I²C 2-WIRE INTERFACE

The PMBus 2-wire interface is an incremental extension of the SMBus. SMBus is built upon I²C with some minor differences in timing, DC parameters and protocol. The PMBus/SMBus protocols are more robust than simple I²C byte commands because PMBus/SMBus provide timeouts to prevent persistent bus errors and optional packet error checking (PEC) to ensure data integrity. In general, a master device that can be configured for I²C communication can be used for PMBus communication with little or no change to hardware or firmware. Repeat start (restart) is not supported by all I²C controllers but is required for SMBus/PMBus reads. If a general purpose I²C controller is used, check that repeat start is supported.

The LTM4664 PSM supports the maximum SMBus clock speed of 100kHz and is compatible with the higher speed PMBus specification (between 100kHz and 400kHz) if MFR_COMMON polling or clock stretching is enabled. For robust communication and operation refer to the Note section in the PMBus command summary. Clock stretching is enabled by asserting bit 1 of MFR_CONFIG_ALL.

For a description of the minor extensions and exceptions PMBus makes to SMBus, refer to PMBus Specification Part 1 Revision 1.2: Paragraph 5: Transport.

For a description of the differences between SMBus and I²C, refer to System Management Bus (SMBus) Specification Version 2.0: Appendix B—Differences Between SMBus and I²C.

PMBus SERIAL DIGITAL INTERFACE

The LTM4664 PSM communicates with a host (master) using the standard PMBus serial bus interface. The Timing Diagram, Figure 10, shows the timing relationship of the signals on the bus. The two-bus lines, SDA and SCL, must be high when the bus is not in use. External pull-up resistors or current sources are required on these lines. The LTM4664 is a slave device. The master can communicate with the LTM4664 using the following formats:

- Master Transmitter, Slave Receiver
- Master Receiver, Slave Transmitter

The following PMBus protocols are supported:

- Write Byte, Write Word, Send Byte
- Read Byte, Read Word, Block Read, Block Write
- Alert Response Address

Figure 11 thru Figure 28 illustrate the aforementioned PMBus protocols. All transactions support PEC and GCP (group command protocol). The Block Read supports 255 bytes of returned data. For this reason, the PMBus timeout may be extended when reading the fault log.

Figure 11 is a key to the protocol diagrams in this section. PEC is optional.

A value shown below a field in the following figures is mandatory value for that field.

The data formats implemented by PMBus are:

- Master transmitter transmits to slave receiver. The transfer direction in this case is not changed.
- Master reads slave immediately after the first byte. At the moment of the first acknowledgment (provided by the slave receiver) the master transmitter becomes a master receiver and the slave receiver becomes a slave transmitter.
- Combined format. During a change of direction within a transfer, the master repeats both a start condition and the slave address but with the R/Wbit reversed. In this case, the master receiver terminates the transfer by generating a NACK on the last byte of the transfer and a STOP condition.

DUAL 25A PSM OPERATION

Refer to Figure 11 for a legend.

Handshaking features are included to ensure robust system communication. Please refer to the PMBus Communication and Command Processing subsection of the Dual 25A PSM Applications Information section for further details.

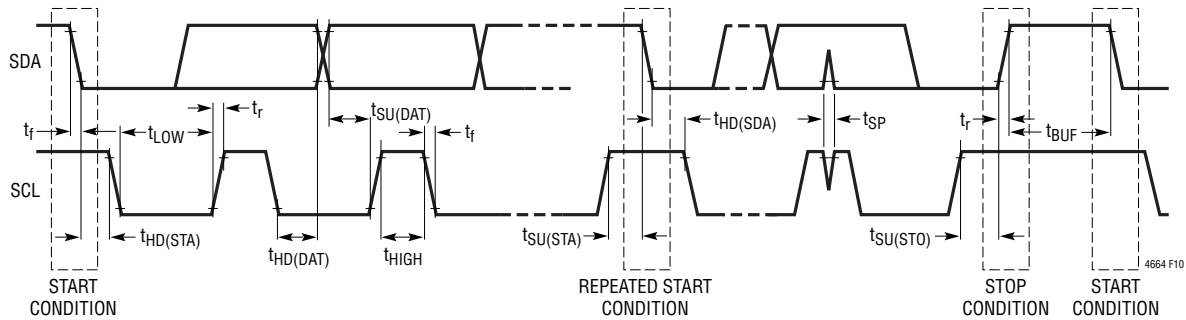

Figure 10. PMBus Timing Diagram

Table 6. Abbreviations of Supported Data Formats

	PMBus		ADI TERMINOLOGY	DEFINITION	EXAMPLE
	TERMINOLOGY	SPECIFICATION REFERENCE			
L11	Linear	Part II ¶7.1	Linear_5s_11s	Floating point 16-bit data: value = $Y \cdot 2^N$, where $N = b[15:11]$ and $Y = b[10:0]$, both two's complement binary integers	$b[15:0] = 0x9807 = 10011_000_0000_0111$ value = $7 \cdot 2^{-13} = 854E-6$
L16	Linear VOUT_MODE	Part II ¶8.2	Linear_16u	Floating point 16-bit data: value = $Y \cdot 2^{-12}$, where $Y = b[15:0]$, an unsigned integer	$b[15:0] = 0x4C00 = 0100_1100_0000_0000$ value = $19456 \cdot 2^{-12} = 4.75$
CF	DIRECT	Part II ¶7.2	Varies	16-bit data with a custom format defined in the detailed PMBus command description	Often an unsigned or two's complement integer
Reg	Register Bits	Part II ¶10.3	Reg	Per-bit meaning defined in detailed PMBus command description	PMBus STATUS_BYTE command
ASC	Text Characters	Part II ¶22.2.1	ASCII	ISO/IEC 8859-1 [A05]	LTC (0x4C5443)

DUAL 25A PSM OPERATION

FIGURE 11 THRU FIGURE 28 PMBus PROTOCOLS

- S START CONDITION
 - Sr REPEATED START CONDITION
 - Rd READ (BIT VALUE OF 1)
 - Wr WRITE (BIT VALUE OF 0)
 - A ACKNOWLEDGE (THIS BIT POSITION MAY BE 0 FOR AN ACK OR 1 FOR A NACK)
 - P STOP CONDITION
 - PEC PACKET ERROR CODE
 - MASTER TO SLAVE
 - SLAVE TO MASTER
 - ... CONTINUATION OF PROTOCOL
- 4664 F11

Figure 11. PMBus Packet Protocol Diagram Element Key

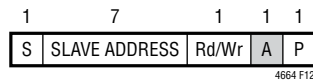

Figure 12. Quick Command Protocol

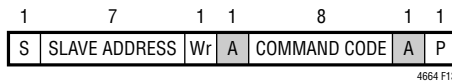

Figure 13. Send Byte Protocol

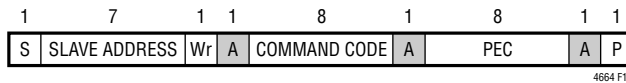

Figure 14. Send Byte Protocol with PEC

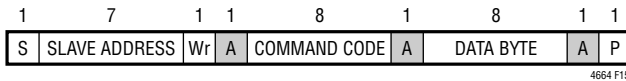

Figure 15. Write Byte Protocol

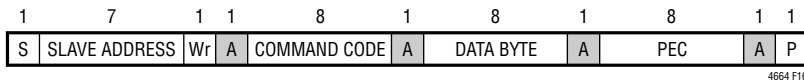

Figure 16. Write Byte Protocol with PEC

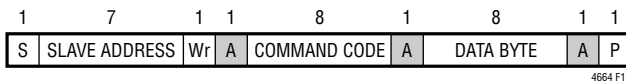

Figure 17. Write Word Protocol

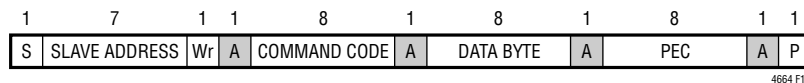

Figure 18. Write Word Protocol with PEC

DUAL 25A PSM OPERATION

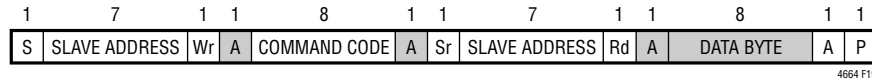

Figure 19. Read Byte Protocol

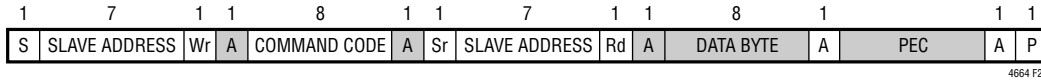

Figure 20. Read Byte Protocol with PEC

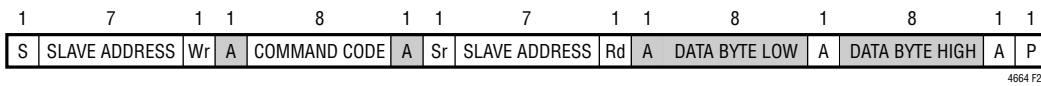

Figure 21. Read Word Protocol

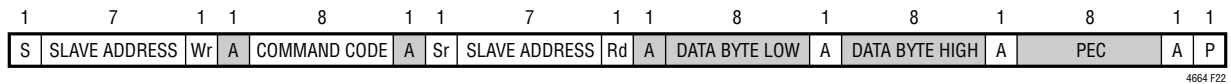

Figure 22. Read Word Protocol with PEC

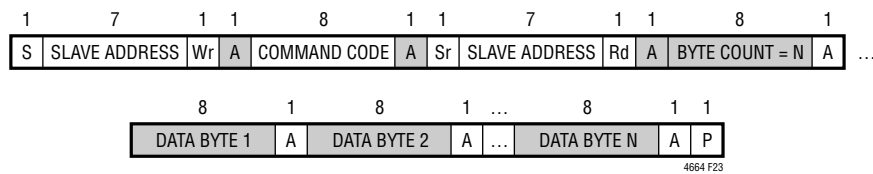

Figure 23. Block Read Protocol

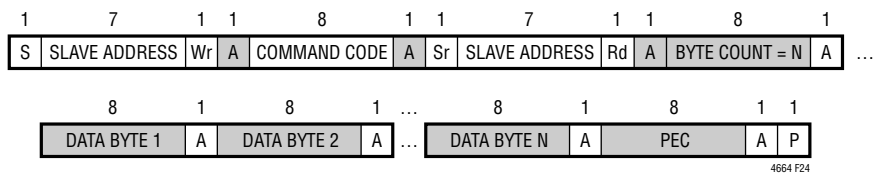

Figure 24. Block Read Protocol with PEC

DUAL 25A PSM OPERATION

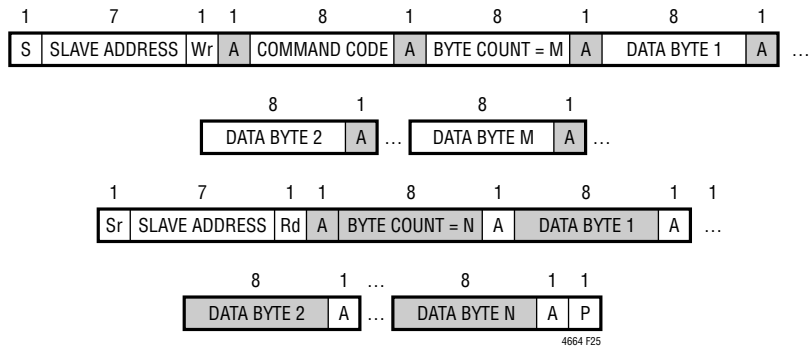

Figure 25. Block Write – Block Read Process Call

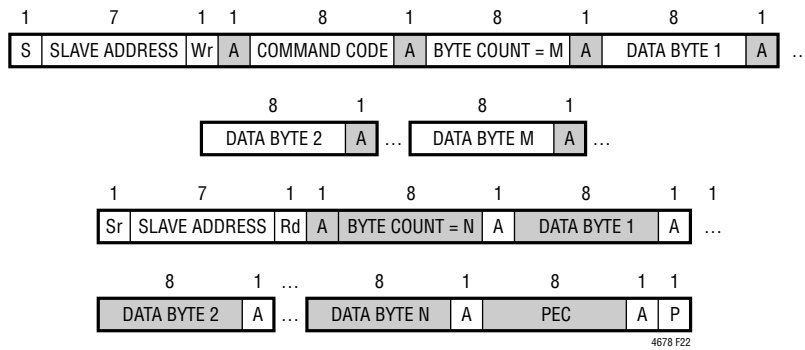

Figure 26. Block Write – Block Read Process Call with PEC

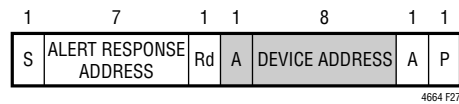

Figure 27. Alert Response Address Protocol

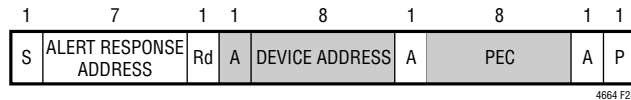

Figure 28. Alert Response Address Protocol with PEC

PMBus COMMAND SUMMARY

PMBus COMMANDS

Table 7 lists supported PMBus commands and manufacturer specific commands. A complete description of these commands can be found in the “PMBus Power System Mgt Protocol Specification – Part II – Revision 1.2”. Users are encouraged to reference this specification. Exceptions or manufacturer specific implementations are listed in Table 7. Floating point values listed in the “DEFAULT VALUE” column are either Linear 16-bit Signed (PMBus Section 8.3.1) or Linear_5s_11s (PMBus Section 7.1) format, whichever is appropriate for the command. All commands from 0xD0 through 0xFF not listed in Table 7 are implicitly reserved by the manufacturer. Users should avoid blind writes within this range of commands to avoid undesired operation of the part. All commands from 0x00 through 0xCF not listed in Table 7 are implicitly

not supported by the manufacturer. Attempting to access non-supported or reserved commands may result in a CML command fault event. All output voltage settings and measurements are based on the VOUT_MODE setting of 0x14. This translates to an exponent of 2^{-12} .

If PMBus commands are received faster than they are being processed, the part may become too busy to handle new commands. In these circumstances the part follows the protocols defined in the PMBus Specification v1.2, Part II, Section 10.8.7, to communicate that it is busy. The part includes handshaking features to eliminate busy errors and simplify error handling software while ensuring robust communication and system behavior. Please refer to the subsection titled PMBus Communication and Command Processing in the Dual 25A PSM Applications Information section for further details.

Table 7. PMBus Commands Summary (Note: The Data Format Abbreviations are Detailed in Table 8)

COMMAND NAME	CMD CODE	DESCRIPTION	TYPE	PAGED	DATA FORMAT	UNITS	NVM	DEFAULT VALUE	PAGE
PAGE	0x00	Provides integration with multi-page PMBus devices.	R/W Byte	N	Reg			0x00	90
OPERATION	0x01	Operating mode control. On/off, margin high and margin low.	R/W Byte	Y	Reg		Y	0x80	94
ON_OFF_CONFIG	0x02	RUN pin and PMBus bus on/off command configuration.	R/W Byte	Y	Reg		Y	0x1E	94
CLEAR_FAULTS	0x03	Clear any fault bits that have been set.	Send Byte	N				NA	119
PAGE_PLUS_WRITE	0x05	Write a command directly to a specified page.	W Block	N					90
PAGE_PLUS_READ	0x06	Read a command directly from a specified page.	Block R/W	N					90
WRITE_PROTECT	0x10	Level of protection provided by the device against accidental changes.	R/W Byte	N	Reg		Y	0x00	91
STORE_USER_ALL	0x15	Store user operating memory to EEPROM.	Send Byte	N				NA	131
RESTORE_USER_ALL	0x16	Restore user operating memory from EEPROM.	Send Byte	N				NA	131
CAPABILITY	0x19	Summary of PMBus optional communication protocols supported by this device.	R Byte	N	Reg			0xB0	118
SMBALERT_MASK	0x1B	Mask ALERT activity	Block R/W	Y	Reg		Y	See CMD	119
VOUT_MODE	0x20	Output voltage format and exponent (2^{-12}).	R Byte	Y	Reg			2^{-12} 0x14	100
VOUT_COMMAND	0x21	Nominal output voltage set point.	R/W Word	Y	L16	V	Y	1.0 0x1000	101
VOUT_MAX	0x24	Upper limit on the commanded output voltage including VOUT_MARGIN_HI.	R/W Word	Y	L16	V	Y	1.8 0x1CCD	100

PMBus COMMAND SUMMARY

COMMAND NAME	CMD CODE	DESCRIPTION	TYPE	PAGED	DATA FORMAT	UNITS	NVM	DEFAULT VALUE	PAGE
VOUT_MARGIN_HIGH	0x25	Margin high output voltage set point. Must be greater than VOUT_COMMAND.	R/W Word	Y	L16	V	Y	1.05 0x10CD	101
VOUT_MARGIN_LOW	0x26	Margin low output voltage set point. Must be less than VOUT_COMMAND.	R/W Word	Y	L16	V	Y	0.95 0x0F33	101
VOUT_TRANSITION_RATE	0x27	Rate the output changes when V _{OUT} commanded to a new value.	R/W Word	Y	L11	V/ms	Y	0.25 0x8042	107
FREQUENCY_SWITCH	0x33	Switching frequency of the controller.	R/W Word	N	L11	kHz	Y	350k 0xFABC	98
VIN_ON	0x35	Input voltage at which the unit should start power conversion.	R/W Word	N	L11	V	Y	4.75 0xCA60	99
VIN_OFF	0x36	Input voltage at which the unit should stop power conversion.	R/W Word	N	L11	V	Y	4.5 0xCA40	99
VOUT_OV_FAULT_LIMIT	0x40	Output overvoltage fault limit.	R/W Word	Y	L16	V	Y	1.1 0x119A	100
VOUT_OV_FAULT_RESPONSE	0x41	Action to be taken by the device when an output overvoltage fault is detected.	R/W Byte	Y	Reg		Y	0xB8	109
VOUT_OV_WARN_LIMIT	0x42	Output overvoltage warning limit.	R/W Word	Y	L16	V	Y	1.075 0x1133	100
VOUT_UV_WARN_LIMIT	0x43	Output undervoltage warning limit.	R/W Word	Y	L16	V	Y	0.925 0x0ECD	101
VOUT_UV_FAULT_LIMIT	0x44	Output undervoltage fault limit.	R/W Word	Y	L16	V	Y	0.9 0x0E66	101
VOUT_UV_FAULT_RESPONSE	0x45	Action to be taken by the device when an output undervoltage fault is detected.	R/W Byte	Y	Reg		Y	0xB8	110
IOUT_OC_FAULT_LIMIT	0x46	Output overcurrent fault limit.	R/W Word	Y	L11	A	Y	40 0xE280	103
IOUT_OC_FAULT_RESPONSE	0x47	Action to be taken by the device when an output overcurrent fault is detected.	R/W Byte	Y	Reg		Y	0x00	112
IOUT_OC_WARN_LIMIT	0x4A	Output overcurrent warning limit.	R/W Word	Y	L11	A	Y	30.0 0xDBC0	104
OT_FAULT_LIMIT	0x4F	External overtemperature fault limit.	R/W Word	Y	L11	C	Y	128 0xF200	105
OT_FAULT_RESPONSE	0x50	Action to be taken by the device when an external overtemperature fault is detected,	R/W Byte	Y	Reg		Y	0xB8	114
OT_WARN_LIMIT	0x51	External overtemperature warning limit.	R/W Word	Y	L11	C	Y	125 0xEBE8	105
UT_FAULT_LIMIT	0x53	External undertemperature fault limit.	R/W Word	Y	L11	C	Y	-45 0xE530	106
UT_FAULT_RESPONSE	0x54	Action to be taken by the device when an external undertemperature fault is detected.	R/W Byte	Y	Reg		Y	0xB8	114
VIN_OV_FAULT_LIMIT	0x55	Input supply overvoltage fault limit.	R/W Word	N	L11	V	Y	15.5 0xD3E0	100
VIN_OV_FAULT_RESPONSE	0x56	Action to be taken by the device when an input overvoltage fault is detected.	R/W Byte	Y	Reg		Y	0x80	109
VIN_UV_WARN_LIMIT	0x58	Input supply undervoltage warning limit.	R/W Word	N	L11	V	Y	4.68 0xCA53	99
IIN_OC_WARN_LIMIT	0x5D	Input supply overcurrent warning limit.	R/W Word	N	L11	A	Y	10.0 0xD280	104

PMBus COMMAND SUMMARY

COMMAND NAME	CMD CODE	DESCRIPTION	TYPE	PAGED	DATA FORMAT	UNITS	NVM	DEFAULT VALUE	PAGE
TON_DELAY	0x60	Time from RUN and/or Operation on to output rail turn-on.	R/W Word	Y	L11	ms	Y	0.0 0x8000	106
TON_RISE	0x61	Time from when the output starts to rise until the output voltage reaches the V_{OUT} commanded value.	R/W Word	Y	L11	ms	Y	3 0xC300	106
TON_MAX_FAULT_LIMIT	0x62	Maximum time from the start of TON_RISE for V_{OUT} to cross the VOUT_UV_FAULT_LIMIT.	R/W Word	Y	L11	ms	Y	5 0xCA80	107
TON_MAX_FAULT_RESPONSE	0x63	Action to be taken by the device when a TON_MAX_FAULT event is detected.	R/W Byte	Y	Reg		Y	0xB8	112
TOFF_DELAY	0x64	Time from RUN and/or Operation off to the start of TOFF_FALL ramp.	R/W Word	Y	L11	ms	Y	0.0 0x8000	107
TOFF_FALL	0x65	Time from when the output starts to fall until the output reaches zero volts.	R/W Word	Y	L11	ms	Y	3 0xC300	107
TOFF_MAX_WARN_LIMIT	0x66	Maximum allowed time, after TOFF_FALL completed, for the unit to decay below 12.5%.	R/W Word	Y	L11	ms	Y	0 0x8000	108
STATUS_BYTE	0x78	One byte summary of the unit's fault condition.	R/W Byte	Y	Reg			NA	120
STATUS_WORD	0x79	Two byte summary of the unit's fault condition.	R/W Word	Y	Reg			NA	121
STATUS_VOUT	0x7A	Output voltage fault and warning status.	R/W Byte	Y	Reg			NA	121
STATUS_IOUT	0x7B	Output current fault and warning status.	R/W Byte	Y	Reg			NA	122
STATUS_INPUT	0x7C	Input supply fault and warning status.	R/W Byte	N	Reg			NA	122
STATUS_TEMPERATURE	0x7D	External temperature fault and warning status for READ_TEMPERATURE_1.	R/W Byte	Y	Reg			NA	123
STATUS_CML	0x7E	Communication and memory fault and warning status.	R/W Byte	N	Reg			NA	123
STATUS_MFR_SPECIFIC	0x80	Manufacturer specific fault and state information.	R/W Byte	Y	Reg			NA	124
READ_VIN	0x88	Measured input supply voltage.	R Word	N	L11	V		NA	128
READ_IIN	0x89	Measured input supply current.	R Word	N	L11	A		NA	128
READ_VOUT	0x8B	Measured output voltage.	R Word	Y	L16	V		NA	128
READ_IOUT	0x8C	Measured output current.	R Word	Y	L11	A		NA	128
READ_TEMPERATURE_1	0x8D	External temperature sensor temperature. This is the value used for all temperature related processing, including IOUT_CAL_GAIN.	R Word	Y	L11	C		NA	128
READ_TEMPERATURE_2	0x8E	Internal die junction temperature. Does not affect any other commands.	R Word	N	L11	C		NA	128
READ_FREQUENCY	0x95	Measured PWM switching frequency.	R Word	Y	L11	Hz		NA	128
READ_POUT	0x96	Measured output power	R Word	Y	L11	W		N/A	128
READ_PIN	0x97	Calculated input power	R Word	Y	L11	W		N/A	129
PMBus_REVISION	0x98	PMBus revision supported by this device. Current revision is 1.2.	R Byte	N	Reg			0x22	118
MFR_ID	0x99	The manufacturer ID of the LTM4664 in ASCII.	R String	N	ASC			LTC	118

PMBus COMMAND SUMMARY

COMMAND NAME	CMD CODE	DESCRIPTION	TYPE	PAGED	DATA FORMAT	UNITS	NVM	DEFAULT VALUE	PAGE
MFR_MODEL	0x9A	Manufacturer part number in ASCII.	R String	N	ASC				118
MFR_VOUT_MAX	0xA5	Maximum allowed output voltage including VOUT_OV_FAULT_LIMIT.	R Word	Y	L16	V		1.8 0x1CCD	102
MFR_PIN_ACCURACY	0xAC	Returns the accuracy of the READ_PIN command	R Byte	N	%			5.0%	129
USER_DATA_00	0xB0	OEM RESERVED. Typically used for part serialization.	R/W Word	N	Reg		Y	NA	118
USER_DATA_01	0xB1	Manufacturer reserved for LTPowerPlay®.	R/W Word	Y	Reg		Y	NA	118
USER_DATA_02	0xB2	OEM RESERVED. Typically used for part serialization	R/W Word	N	Reg		Y	NA	118
USER_DATA_03	0xB3	An NVM word available for the user.	R/W Word	Y	Reg		Y	0x0000	118
USER_DATA_04	0xB4	An NVM word available for the user.	R/W Word	N	Reg		Y	0x0000	118
MFR_EE_UNLOCK	0xBD	Contact factory.							136
MFR_EE_ERASE	0xBE	Contact factory.							136
MFR_EE_DATA	0xBF	Contact factory.							136
MFR_CHAN_CONFIG	0xD0	Configuration bits that are channel specific.	R/W Byte	Y	Reg		Y	0x1D	92
MFR_CONFIG_ALL	0xD1	General configuration bits.	R/W Byte	N	Reg		Y	0x21	93
MFR_FAULT_PROPAGATE	0xD2	Configuration that determines which faults are propagated to the FAULT pin.	R/W Word	Y	Reg		Y	0x6993	115
MFR_PWM_COMP	0xD3	PWM loop compensation configuration	R/W Byte	Y	Reg		Y	0x28	96
MFR_PWM_MODE	0xD4	Configuration for the PWM engine.	R/W Byte	Y	Reg		Y	0xC7	95
MFR_FAULT_RESPONSE	0xD5	Action to be taken by the device when the FAULT pin is externally asserted low.	R/W Byte	Y	Reg		Y	0xC0	113
MFR_OT_FAULT_RESPONSE	0xD6	Action to be taken by the device when an internal overtemperature fault is detected.	R Byte	N	Reg			0xC0	113
MFR_IOUT_PEAK	0xD7	Report the maximum measured value of READ_IOUT since last MFR_CLEAR_PEAKS.	R Word	Y	L11	A		NA	129
MFR_ADC_CONTROL	0xD8	ADC telemetry parameter selected for repeated fast ADC read back	R/W Byte	N	Reg			0x00	130
MFR_RETRY_DELAY	0xDB	Retry interval during FAULT retry mode.	R/W Word	Y	L11	ms	Y	250.0 0xF3E8	108
MFR_RESTART_DELAY	0xDC	Minimum time the RUN pin is held low by the LTM4664.	R/W Word	Y	L11	ms	Y	150 0xF258	108
MFR_VOUT_PEAK	0xDD	Maximum measured value of READ_VOUT since last MFR_CLEAR_PEAKS.	R Word	Y	L16	V		NA	129
MFR_VIN_PEAK	0xDE	Maximum measured value of READ_VIN since last MFR_CLEAR_PEAKS.	R Word	N	L11	V		NA	129
MFR_TEMPERATURE_1_PEAK	0xDF	Maximum measured value of external Temperature (READ_TEMPERATURE_1) since last MFR_CLEAR_PEAKS.	R Word	Y	L11	C		NA	129
MFR_READ_IIN_PEAK	0xE1	Maximum measured value of READ_IIN command since last MFR_CLEAR_PEAKS	R Word	N	L11	A		NA	129
MFR_CLEAR_PEAKS	0xE3	Clears all peak values.	Send Byte	N				NA	120
MFR_READ_ICHIP	0xE4	Measured supply current of the SV _{IN} pin	R Word	N	L11	A		NA	129

PMBus COMMAND SUMMARY

COMMAND NAME	CMD CODE	DESCRIPTION	TYPE	PAGED	DATA FORMAT	UNITS	NVM	DEFAULT VALUE	PAGE
MFR_IOUT_CAL_GAIN	0xDA	The ratio of the voltage at the current sense pins to the sensed current. For devices using a fixed current sense resistor. It is the resistance value in mohm. 0xAA8B set at factory	R Word	Y	L11			0.350mΩ	102
MFR_PADS	0xE5	Digital status of the I/O pads.	R Word	N	Reg		Y	NA	125
MFR_ADDRESS	0xE6	Sets the 7-bit I ² C address byte.	R/W Byte	N	Reg		Y	0x4F	92
MFR_SPECIAL_ID	0xE7	Manufacturer code representing the LTM4664 and revision	R Word	N	Reg			0x4100	118
MFR_IIN_CAL_GAIN	0xE8	The resistance value of the input current sense element in mΩ.	R/W Word	N	L11	mΩ	Y	2.0 0xC200	104
MFR_FAULT_LOG_STORE	0xEA	Command a transfer of the fault log from RAM to EEPROM.	Send Byte	N				NA	132
MFR_INFO	0xB6	Contact factory.							136
MFR_FAULT_LOG_CLEAR	0xEC	Initialize the EEPROM block reserved for fault logging.	Send Byte	N				NA	136
MFR_FAULT_LOG	0xEE	Fault log data bytes.	R Block	N	Reg		Y	NA	132
MFR_COMMON	0xEF	Manufacturer status bits that are common across multiple ADI chips.	R Byte	N	Reg			NA	126
MFR_COMPARE_USER_ALL	0xF0	Compares current command contents with NVM.	Send Byte	N				NA	131
MFR_TEMPERATURE_2_PEAK	0xF4	Peak internal die temperature since last MFR_CLEAR_PEAKS.	R Word	N	L11	C		NA	130
MFR_PWM_CONFIG	0xF5	Set numerous parameters for the DC/DC controller including phasing.	R/W Byte	N	Reg		Y	0x10	97
MFR_IOUT_CAL_GAIN_TC	0xF6	Temperature coefficient of the current sensing element.	R/W Word	Y	CF	ppm/ °C	Y	3900 0x0F3C	102
MFR_RVIN	0xF7	The resistance value of the V _{IN} pin filter element in mΩ. Set at Factory	R/W Word	N	L11	mΩ	Y	1000 0x03E8	99
MFR_TEMP_1_GAIN	0xF8	Sets the slope of the external temperature sensor.	R/W Word	Y	CF		Y	0.9 0x3FAE	105
MFR_TEMP_1_OFFSET	0xF9	Sets the offset of the external temperature sensor with respect to -273.1°C	R/W Word	Y	L11	C	Y	0.0 0x8000	105
MFR_RAIL_ADDRESS	0xFA	Common address for PolyPhase outputs to adjust common parameters.	R/W Byte	Y	Reg		Y	0x80	92
MFR_REAL_TIME	0xFB	48-bit share-clock counter value.	R Block	N	CF			NA	xx
MFR_RESET	0xFD	Commanded reset without requiring a power down.	Send Byte	N				NA	94

Note 1: Commands indicated with Y in the NVM column indicate that these commands are stored and restored using the STORE_USER_ALL and RESTORE_USER_ALL commands, respectively.

Note 2: Commands with a default value of NA indicate “not applicable”. Commands with a default value of FS indicate “factory set on a per part basis”.

Note 3: The LTM4664 contains additional commands not listed in Table 7. Reading these commands is harmless to the operation of the IC; however, the contents and meaning of these commands can change without notice.

Note 4: Some of the unpublished commands are read-only and will generate a CML bit 6 fault if written.

Note 5: Writing to commands not published in Table 7 is not permitted.

Note 6: The user should not assume compatibility of commands between different parts based upon command names. Always refer to the manufacturer’s data sheet for each part for a complete definition of a command’s function. ADI strives to keep command functionality compatible between all ADI devices. Differences may occur to address specific product requirements.

PMBus COMMAND SUMMARY

Table 8. Data Format Abbreviations

L11	Linear_5s_11s	<p>PMBus data field b[15:0] Value = $Y \cdot 2^N$ where N = b[15:11] is a 5-bit two's complement integer and Y = b[10:0] is an 11-bit two's complement integer Example: For b[15:0] = 0x9807 = 'b10011_000_0000_0111 Value = $7 \cdot 2^{-13} = 854 \cdot 10^{-6}$ From "PMBus Spec Part II: Paragraph 7.1"</p>
L16	Linear_16u	<p>PMBus data field b[15:0] Value = $Y \cdot 2^N$ where Y = b[15:0] is an unsigned integer and N = VOUT_MODE_PARAMETER is a 5-bit two's complement exponent that is hardwired to -12 decimal Example: For b[15:0] = 0x9800 = 'b1001_1000_0000_0000 Value = $19456 \cdot 2^{-12} = 4.75$ From "PMBus Spec Part II: Paragraph 8.2"</p>
Reg	Register	<p>PMBus data field b[15:0] or b[7:0]. Bit field meaning is defined in detailed PMBus Command Description.</p>
L16	Integer Word	<p>PMBus data field b[15:0] Value = Y where Y = b[15:0] is a 16-bit unsigned integer Example: For b[15:0] = 0x9807 = 'b1001_1000_0000_0111 Value = 38919 (decimal)</p>
CF	Custom Format	<p>Value is defined in detailed PMBus Command Description. This is often an unsigned or two's complement integer scaled by an MFR specific constant.</p>
ASC	ASCII Format	<p>A variable length string of text characters conforming to ISO/IEC 8859-1 standard.</p>

DUAL 25A PSM APPLICATIONS INFORMATION

V_{IN} TO V_{OUT} STEP-DOWN RATIOS

There are restrictions in the maximum V_{IN} and V_{OUT} step-down ratio that can be achieved for a given input voltage. Each output of the LTM4664 PSM is capable of 95% duty cycle at 500kHz, but the V_{IN} to V_{OUT} minimum dropout is still a function of its load current and will limit output current capability related to high duty cycle on the topside switch.

Minimum on-time t_{ON(MIN)} is another consideration in operating at a specified duty cycle while operating at a certain frequency due to the fact that t_{ON(MIN)} < D/f_{SW}, where D is duty cycle and f_{SW} is the switching frequency. t_{ON(MIN)} is specified in the electrical parameters as 60ns. See Note 6 in the Electrical Characteristics section for output current guideline. Since the LTM4664 front end 4:1 divider feeds the two 25A PSM channels with a V_{OUT2} range of 7.5V to 14.5V, there should be no minimum on time issue.

INPUT CAPACITORS

The LTM4664 PSM channels should be connected to a low AC impedance DC source. For the regulator input, four 22μF input ceramic capacitors are used to handle the RMS ripple current. A 47μF to 100μF surface mount aluminum electrolytic bulk capacitor can be used for more input bulk capacitance. This bulk input capacitor is only needed if the input source impedance is compromised by long inductive leads, traces or not enough source capacitance. If low impedance power planes are used, then this bulk capacitor is not needed.

For a buck converter, the switching duty-cycle can be estimated as:

$$D_n = \frac{V_{OUTn}}{V_{INn}}$$

Without considering the inductor current ripple, for each output, the RMS current of the input capacitor can be estimated as:

$$I_{CINn(RMS)} = \frac{I_{OUTn(MAX)}}{\eta\%} \cdot \sqrt{D_n \cdot (1 - D_n)}$$

In the above equation, η% is the estimated efficiency of the power module. The bulk capacitor can be a switcher-rated electrolytic aluminum capacitor, or a polymer capacitor.

OUTPUT CAPACITORS

The LTM4664 PSM channel outputs are designed for low output voltage ripple noise and good transient response. The bulk output capacitors defined as C_{OUT} are chosen with low enough effective series resistance (ESR) to meet the output voltage ripple and transient requirements. C_{OUT} can be a low ESR tantalum capacitor, a low ESR polymer capacitor or ceramic capacitor. The typical output capacitance range for each output is from 400μF to 1000μF. Additional output filtering may be required by the system designer, if further reduction of output ripple or dynamic transient spikes is required. Table 12 shows a matrix of different output voltages and output capacitors to minimize the voltage droop and overshoot during a 12.5A to 25A step, 12A/μs transient each channel. Table 12 optimizes total equivalent ESR and total bulk capacitance to optimize the transient performance. Stability criteria are considered in the Table 12 matrix, and the LTpowerCAD Design Tool will be provided for stability analysis. Multiphase operation reduces effective output ripple as a function of the number of phases. [Application Note 77](#) discusses this noise reduction versus output ripple current cancellation, but the output capacitance should be considered carefully as a function of stability and transient response. The LTpowerCAD Design Tool can calculate the output ripple reduction as the number of implemented phases increases by N times. A small value 10Ω resistor can be placed in series from V_{OUTn} to the V_{OSNSO}⁺ pin to allow for a bode plot analyzer to inject a signal into the control loop and validate the regulator stability. The LTM4664 PSM stability compensation can be adjusted using two external capacitors, and the MFR_PWM_COMP commands.

LIGHT LOAD CURRENT OPERATION

The LTM4664 PSM channels have two modes of operation including high efficiency, discontinuous conduction mode or forced continuous conduction mode. The mode of operation is configured by bit 0 of the MFR_PWM_MODE_n command (discontinuous conduction is always the start-up mode, forced continuous is the default running mode).

If a channel is enabled for discontinuous mode operation, the inductor current is not allowed to reverse. The

DUAL 25A PSM APPLICATIONS INFORMATION

reverse current comparator, I_{REV} , turns off the bottom MOSFET (MB_n) just before the inductor current reaches zero, preventing it from reversing and going negative. Thus, the controller can operate in discontinuous (pulse-skipping) operation. In forced continuous operation, the inductor current is allowed to reverse at light loads or under large transient conditions. The peak inductor current is determined solely by the voltage on the $COMP_{Cn}$ pin. In this mode, the efficiency at light loads is lower than in discontinuous mode operation. However, continuous mode exhibits lower output ripple and less interference with audio circuitry. Forced continuous conduction mode may result in reverse inductor current, which can cause the input supply to boost. The $VIN_{OV_FAULT_LIMIT}$ can detect this on V_{IN3} and turn off the offending channel. However, this fault is based on an ADC read and can nominally take up to 100ms to detect. If there is a concern about the input supply boosting, keep the part in discontinuous conduction operation.

SWITCHING FREQUENCY AND PHASE

The switching frequency of the LTM4664's PSM channels is established by its analog phase-locked-loop (PLL) locking on to the clock present at the module's SYNC pin. The clock waveform on the SYNC pin can be generated by the LTM4664's PSM internal circuitry when an external pull-up resistor to 3.3V (e.g., V_{DD33}) is provided, in combination with the LTM4664 PSM control IC's $FREQUENCY_SWITCH$ command being set to one of the following supported values: 250kHz, 350kHz, 425kHz, 500kHz, 575kHz, 650kHz, 750kHz. In this configuration, the module is called a "sync master": (using the factory-default setting of $MFR_CONFIG_ALL[4] = 0b$), SYNC becomes a bidirectional open-drain pin, and the LTM4664 PSM pulls SYNC logic low for nominally 500ns at a time, at the prescribed clock rate. The SYNC signal can be bused to other LTM4664 PSM device modules (configured as "sync slaves"), for purposes of synchronizing switching frequencies of multiple modules within a system—but only one LTM4664 PSM devices should be configured as a "sync master"; the other LTM4664(s) should be configured as "sync slaves".

The most straightforward way is to set its $FREQUENCY_SWITCH$ command to 0x0000 and

$MFR_CONFIG_ALL[4] = 1b$. This can be easily implemented with resistor pin-strap settings on the $FSWPH_CFG$ pin (see Table 3). Using $MFR_CONFIG_ALL[4] = 1b$, the LTM4664's SYNC pin becomes a high impedance input, only—i.e., it does not drive SYNC low. The module synchronizes its frequency to that of the clock applied to its SYNC pin. The only shortcoming of this approach is: in the absence of an externally applied clock, the switching frequency of the module will default to the low end of its frequency-synchronization capture range (~225kHz).

If fault-tolerance to the loss of an externally applied SYNC clock is desired, the $FREQUENCY_SWITCH$ command of a "sync slave" can be left at the nominal target switching frequency of the application, and not 0x0000. However, it is then still necessary to configure $MFR_CONFIG_ALL[4] = 1b$. With this combination of configurations, the LTM4664's SYNC pin becomes a high impedance input and the module synchronizes its frequency to that of the externally applied clock, provided that the frequency of the externally applied clock exceeds $\sim 1/2$ of the target frequency ($FREQUENCY_SWITCH$). If the SYNC clock is absent, the module responds by operating at its target frequency, indefinitely. If and when the SYNC clock is restored, the module automatically phase-locks to the SYNC clock as normal. The only shortcoming of this approach is: the EEPROM must be configured per above guidance; resistor pin-strapping options on the $FSWPH_CFG$ pin alone cannot provide fault-tolerance to the absence of the SYNC clock.

The $FREQUENCY_SWITCH$ register can be altered via I²C commands, but only when switching action is disengaged, i.e., the module's outputs are turned off. The $FREQUENCY_SWITCH$ command takes on the value stored in NVM at V_{INS3} power-up, but is overridden according to a resistor pin-strap applied between the $FSWPH_CFG$ pin and SGND only if the module is configured to respect resistor pin-strap settings ($MFR_CONFIG_ALL[6] = 0b$). Table 3 highlights available resistor pin-strap and corresponding $FREQUENCY_SWITCH$ settings.

The relative phasing of all active channels in a PolyPhase rail should be optimally phased. The relative phasing of each rail is $360^\circ/n$, where n is the number of phases in the rail. $MFR_PWM_CONFIG[2:0]$ configures channel relative

DUAL 25A PSM APPLICATIONS INFORMATION

phasing with respect to the SYNC pin. Phase relationship values are indicated with 0° corresponding to the falling edge of SYNC being coincident with the turn-on of the top MOSFETs, MT_n .

The MFR_PWM_CONFIG command can be altered via I²C commands, but only when switching action is disengaged, i.e., the module's outputs are turned off. The MFR_PWM_CONFIG command takes on the value stored in NVM at SV_{IN} power-up, but is overridden according to a resistor pin-strap applied between the FSWPH_CFG pin and SGND only if the module is configured to respect resistor pin-strap settings (MFR_CONFIG_ALL[6] = 0b). Table 3 highlights available resistor pin-strap and corresponding MFR_PWM_CONFIG[2:0] settings.

Some combinations of FREQUENCY_SWITCH and MFR_PWM_CONFIG[2:0] are not available by resistor pin-straping the FSWPH_CFG pin. All combinations of supported values for FREQUENCY_SWITCH and MFR_PWM_CONFIG[2:0] can be configured by NVM programming—or, I²C transactions, provided switching action is disengaged, i.e., the module's outputs are turned off.

Care must be taken to minimize capacitance on SYNC to assure that the pull-up resistor versus the capacitor load has a low enough time constant for the application to form a “clean” clock. (See “Open-Drain Pins”, later in this section.)

When an LTM4664 PSM is configured as a sync slave, it is permissible for external circuitry to drive the SYNC pin from a current-limited source (less than 10mA), rather than using a pull-up resistor. Any external circuitry must not drive high with arbitrarily low impedance at SV_{IN} power-up, because the SYNC output can be low impedance until NVM contents have been downloaded to RAM.

Recommended LTM4664 PSM switching frequencies of operation for many common V_{IN} -to- V_{OUT} applications are indicated below. When the two channels of an LTM4664 PSM are stepping input voltage(s) down to output voltages whose recommended switching frequencies below are significantly different, operation at the higher of the two recommended switching frequencies is preferable, but minimum on-time must be considered. (See Minimum On-Time Considerations section.)

Table 9. Recommended PSM Switching Frequency for Various V_{IN} -to- V_{OUT} Step-Down Scenarios

V	7.5V _{IN}	10V _{IN}	12V _{IN}	14.5V _{IN}
0.5	250kHz	250kHz	250kHz	250kHz
0.7				
0.8				
0.9				
1.0	350kHz	350kHz	350kHz	350kHz
1.2				
1.5				

OUTPUT CURRENT LIMIT PROGRAMMING

The cycle-by-cycle current limit ($= V_{ISENSE}/DCR$) is proportional to COMP_C_n, which can be programmed from 1.45V to 2.2V using the PMBus command IOUT_OC_FAULT_LIMIT. The LTM4664 PSM uses only the sub-milliohm sensing to detect current levels. See page103. The LTM4664 PSM has two ranges of current limit programming. The value of MFR_PWM_MODE[2] is reserved and the MFR_PWM_MODE[7], and IOUT_OC_FAULT_LIMIT are used to set the current limit level, see the section of the PMBus commands, the device can regulate output voltage with the peak current under the value of IOUT_OC_FAULT_LIMIT in normal operation. In case of output current exceeding that current limit, a OC fault will be issued. Each of the IOUT_OC_FAULT_LIMIT ranges will effects the loop gain, and subsequently effects the loop stability, so setting the range of current limiting is a part of loop design.

The LTpowerCAD Design Tool can be used to look at the loop stability changes if current limit is adjusted. The LTM4664 PSM will automatically update the current limit as the inductor temperature changes. Keep in mind this operation is on a cycle-by-cycle basis and is only a function of the peak inductor current. The average inductor current is monitored by the ADC converter and can provide a warning if too much average output current is detected. The overcurrent fault is detected when the COMP_C_n voltage hits the maximum value. The digital processor within the LTM4664 PSM provides the ability to either ignore the fault, shut down and latch off or shut down and retry indefinitely (hiccup). Refer to the overcurrent portion of the Dual 25A PSM Operation section for more detail. The Read_POUT can be used to readback calculated output power.

DUAL 25A PSM APPLICATIONS INFORMATION

MINIMUM ON-TIME CONSIDERATIONS

Minimum on-time, $t_{ON(MIN)}$, is the smallest time duration that the LTM4664 PSM is capable of turning on the top MOSFET. It is determined by internal timing delays and the gate charge required to turn on the top MOSFET. Low duty cycle applications may approach this minimum on-time limit and care should be taken to ensure that:

$$t_{ON(MIN)} < \frac{V_{OUTn}}{V_{INn} \cdot f_{OSC}}$$

If the duty cycle falls below what can be accommodated by the minimum on-time, the controller will begin to skip cycles. The output voltage will continue to be regulated, but the ripple voltage and current will increase.

The minimum on-time for the LTM4664 is 60ns.

VARIABLE DELAY TIME, SOFT-START AND OUTPUT VOLTAGE RAMPING

The LTM4664 PSM must enter its run state prior to soft-start. The RUN_Cn pins are released after the part initializes, and V_{INS3} is greater than the VIN_ON threshold and Stage 2 PGood pin releases the RUN_Cn pins. If multiple LTM4664s are used in an application, they should be configured to share the same RUN_Cn pins. They all hold their respective RUN_Cn pins low until all devices initialize and V_{INS3} exceeds the VIN_ON threshold for all devices. The $SHARE_CLK$ pin assures all the devices connected to the signal use the same time base.

After the RUN_Cn pin releases, the controller waits for the user-specified turn-on delay (TON_DELAYn) prior to initiating an output voltage ramp. Multiple LTM4664s and other ADI parts can be configured to start with variable delay times. To work correctly, all devices use the same timing clock ($SHARE_CLK$) and all devices must share the RUN_Cn pin.

This allows the relative delay of all parts to be synchronized. The actual variation in the delay will be dependent on the highest clock rate of the devices connected to the $SHARE_CLK$ pin (all Linear Technology ICs are configured to allow the fastest $SHARE_CLK$ signal to control the timing of all devices). The $SHARE_CLK$ signal can be

$\pm 10\%$ in frequency, thus the actual time delays will have some variance.

Soft-start is performed by actively regulating the load voltage while digitally ramping the target voltage from 0V to the commanded voltage set point. The rise time of the voltage ramp can be programmed using the TON_RISEn command to minimize inrush currents associated with the start-up voltage ramp. The soft-start feature is disabled by setting TON_RISEn to any value less than 0.250ms. The LTM4664 PSM performs the necessary math internally to assure the voltage ramp is controlled to the desired slope. However, the voltage slope can not be any faster than the V_{OUTn} fundamental limits of the power stage. The number of $t_{ON(MIN)} < steps$ in the ramp is equal to $TON_RISE/0.1ms$. Therefore, the shorter the TON_RISEn time setting, the more discrete steps in the soft-start ramp appear.

The LTM4664 PSM PWM always operates in discontinuous mode during the TON_RISEn operation. In discontinuous mode, the bottom MOSFET (MBn) is turned off as soon as reverse current is detected in the inductor. This allows the regulator to start up into a prebiased load.

There is no analog tracking feature in the LTM4664 PSM; however, two outputs can be given the same TON_RISEn and TON_DELAYn times to achieve ratiometric rail tracking. Because the $RUNn$ pins are released at the same time and both units use the same time base ($SHARE_CLK$), the outputs track very closely. If the circuit is in a PolyPhase configuration, all timing parameters must be the same.

DIGITAL SERVO MODE

For maximum accuracy in the regulated output voltage, enable the digital servo loop by asserting bit 6 of the MFR_PWM_MODE command. In digital servo mode, the LTM4664 PSM will adjust the regulated output voltage based on the ADC voltage reading. Every 90ms the digital servo loop will step the LSB of the DAC (nominally 1.375mV or 0.6875mV depending on the voltage range bit) until the output is at the correct ADC reading. At power-up this mode engages after $TON_MAX_FAULT_LIMIT$ unless the limit is set to 0 (infinite). If the $TON_MAX_FAULT_LIMIT$ is set to 0 (infinite), the servo begins after TON_RISE is complete and V_{OUT} has exceeded the

DUAL 25A PSM APPLICATIONS INFORMATION

VOUT_UV_FAULT_LIMIT. This same point in time is when the output changes from discontinuous to the programmed mode as indicated in MFR_PWM_MODE bit 0. Refer to Figure 29 for details on the V_{OUT} waveform under time-based sequencing. If the TON_MAX_FAULT_LIMIT is set to a value greater than 0 and the TON_MAX_FAULT_RESPONSE is set to ignore 0x00, the servo begins:

1. After the TON_RISE sequence is complete
2. After the TON_MAX_FAULT_LIMIT time is reached; and
3. After the VOUT_UV_FAULT_LIMIT has been exceeded or the IOUT_OC_FAULT_LIMIT is no longer active.

If the TON_MAX_FAULT_LIMIT is set to a value greater than 0 and the TON_MAX_FAULT_RESPONSE is not set to ignore 0x00, the servo begins:

1. After the TON_RISE sequence is complete
2. After the TON_MAX_FAULT_LIMIT time has expired and both VOUT_UV_FAULT and IOUT_OC_FAULT are not present.

The maximum rise time is limited to 1.3 seconds.

In a PolyPhase configuration it is recommended only one of the control loops have the digital servo mode enabled. This will assure the various loops do not work against each other due to slight differences in the reference circuits.

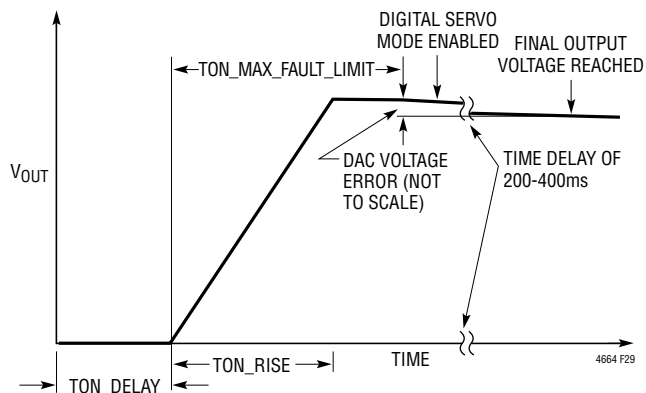

Figure 29. Timing Controlled V_{OUT} Rise

SOFT OFF (SEQUENCED OFF)

In addition to a controlled start-up, the LTM4664 PSM also supports controlled turn-off. The TOFF_DELAY and TOFF_FALL functions are shown in Figure 30. TOFF_FALL is processed when the RUN pin goes low or if the part is commanded off. If the part faults off or $\overline{FAULT_Cn}$ is pulled low externally and the part is programmed to respond to this, the output will three-state rather than exhibiting a controlled ramp. The output will decay as a function of the load. The output voltage will operate as shown in Figure 30 as long as the part is in forced continuous mode and the TOFF_FALL time is sufficiently slow that the power stage can achieve the desired slope. The TOFF_FALL time can only be met if the power stage and controller can sink sufficient current to assure the output is at zero volts by the end of the fall time interval. If the TOFF_FALL time is set shorter than the time required to discharge the load capacitance, the output will not reach the desired zero volt state. At the end of TOFF_FALL, the controller will cease to sink current and V_{OUT} will decay at the natural rate determined by the load impedance. If the controller is in discontinuous mode, the controller will not pull negative current and the output will be pulled low by the load, not the power stage. The maximum fall time is limited to 1.3 seconds. The shorter TOFF_FALL time is set, the larger the discrete steps in the TOFF_FALL ramp will appear. The number of steps in the ramp is equal to TOFF_FALL/0.1ms.

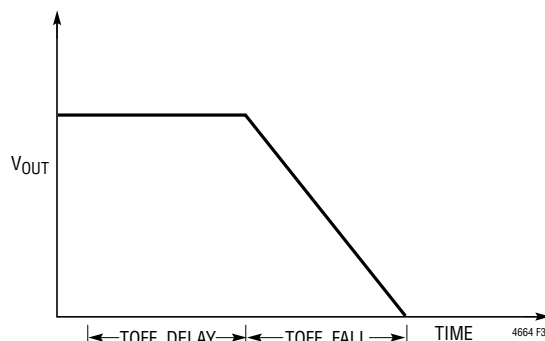

Figure 30. TOFF_DELAY and TOFF_FALL

DUAL 25A PSM APPLICATIONS INFORMATION

UNDERVOLTAGE LOCKOUT

The LTM4664 PSM is initialized by an internal threshold-based UVLO where V_{INS3} must be approximately 4V and $INTV_{CC}$, V_{DD33} , and V_{DD25} must be within approximately 20% of their regulated values. In addition, V_{DD33} must be within approximately 7% of the targeted value before the RUN_{Cn} pin is released. After the part has initialized, an additional comparator monitors V_{INS3} . The VIN_{ON} threshold must be exceeded before the power sequencing can begin. When V_{INS3} drops below the VIN_{OFF} threshold, the $SHARE_{CLK}$ pin will be pulled low and V_{INS3} must increase above the VIN_{ON} threshold before the controller will restart. The normal start-up sequence will be allowed after the VIN_{ON} threshold is crossed. If $FAULTB$ is held low when V_{INS3} is applied, $ALERT$ will be asserted low even if the part is programmed to not assert $ALERT$ when $FAULTB$ is held low. If I²C communication occurs before the LTM4664 is out of reset and only a portion of the command is seen by the part, this can be interpreted as a CML fault. If a CML fault is detected, $ALERT$ is asserted low.

It is possible to program the contents of the NVM in the application if the V_{DD33} supply is externally driven directly to V_{DD33} or through $EXTV_{CC}$. This will activate the digital portion of the LTM4664 PSM without engaging the high voltage sections. PMBus communications are valid in this supply configuration. If V_{INS3} has not been applied to the LTM4664 PSM, bit 3 (NVM Not Initialized) in MFR_{COMMON} will be asserted low. If this condition is detected, the part will only respond to addresses 5A and 5B. To initialize the part issue the following set of commands: global address 0x5B command 0xBD data 0x2B followed by global address 5B command 0xBD and data 0xC4. The part will now respond to the correct address. Configure the part as desired then issue a $STORE_{USER}_{ALL}$. When V_{IN} is applied a MFR_{RESET} command must be issued to allow the PWM to be enabled and valid ADC conversions to be read.

FAULT DETECTION AND HANDLING

The LTM4664 \overline{FAULT}_{Cn} pins are configurable to indicate a variety of faults including OV, UV, OC, OT, timing faults, and peak over current faults. In addition, the \overline{FAULT}_{Cn}

pins can be pulled low by external sources indicating a fault in some other portion of the system. The fault response is configurable and allows the following options:

- Ignore
- Shut Down Immediately—Latch Off
- Shut Down Immediately—Retry Indefinitely at the Time Interval Specified in MFR_{RETRY}_{DELAY}

Refer to the PMBus section of the data sheet and the PMBus specification for more details.

The OV response is automatic. If an OV condition is detected, TGn goes low and BGn is asserted.

Fault logging is available on the LTM4664 PSM. The fault logging is configurable to automatically store data when a fault occurs that causes the unit to fault off. The header portion of the fault logging table contains peak values. It is possible to read these values at any time. This data will be useful while troubleshooting the fault.

If the LTM4664 PSM internal temperature is in excess of 85°C, writes into the NVM (other than fault logging) are not recommended. The data will still be held in RAM, unless the 3.3V supply UVLO threshold is reached. If the die temperature exceeds 130°C all NVM communication is disabled until the die temperature drops below 120°C.

OPEN-DRAIN PINS

The LTM4664 PSM has the following open-drain pins:

3.3V Pins

1. \overline{FAULT}_{Cn}
2. SYNC
3. $SHARE_{CLK}$
4. $PGOOD_{Cn}$

5V Pins (5V pins operate correctly when pulled to 3.3V.)

1. RUN_{Cn}
2. \overline{ALERT}
3. SCL
4. SDA

DUAL 25A PSM APPLICATIONS INFORMATION

All the above pins have on-chip pull-down transistors that can sink 3mA at 0.4V. The low threshold on the pins is 0.8V; thus, there is plenty of margin on the digital signals with 3mA of current. For 3.3V pins, 3mA of current is a 1.1k resistor. Unless there are transient speed issues associated with the RC time constant of the resistor pull-up and parasitic capacitance to ground, a 10k resistor or larger is generally recommended.

For high speed signals such as the SDA, SCL and SYNC, a lower value resistor may be required. The RC time constant should be set to 1/3 to 1/5 the required rise time to avoid timing issues. For a 100pF load and a 400kHz PMBus communication rate, the rise time must be less than 300ns. The resistor pull-up on the SDA and SCL pins with the time constant set to 1/3 the rise time is:

$$R_{\text{PULLUP}} = \frac{t_{\text{RISE}}}{3 \cdot 100\text{pF}} = 1\text{k}$$

The closest 1% resistor value is 1k. Be careful to minimize parasitic capacitance on the SDA and SCL pins to avoid communication problems. To estimate the loading capacitance, monitor the signal in question and measure how long it takes for the desired signal to reach approximately 63% of the output value. This is a one time constant. The SYNC pin has an on-chip pull-down transistor with the output held low for nominally 500ns. If the internal oscillator is set for 500kHz and the load is 100pF and a 3x time constant is required, the resistor calculation is as follows:

$$R_{\text{PULLUP}} = \frac{2\mu\text{s} - 500\text{ns}}{3 \cdot 100\text{pF}} = 5\text{k}$$

The closest 1% resistor is 4.99k.

If timing errors are occurring or if the SYNC frequency is not as fast as desired, monitor the waveform and determine if the RC time constant is too long for the application. If possible reduce the parasitic capacitance. If not, reduce the pull-up resistor sufficiently to assure proper timing. The SHARE_CLK pull-up resistor has a similar equation with a period of 10μs and a pull-down time of 1μs. The RC time constant should be approximately 3μs or faster.

PHASE-LOCKED LOOP AND FREQUENCY SYNCHRONIZATION

The LTM4664 PSM has a phase-locked loop (PLL) comprised of an internal voltage-controlled oscillator (VCO) and a phase detector. The PLL is locked to the falling edge of the SYNC pin. The phase relationship between the PWM controller and the falling edge of SYNC is controlled by the lower 3 bits of the MFR_PWM_CONFIG command. For PolyPhase applications, it is recommended that all the phases be spaced evenly. Thus for a 2-phase system the signals should be 180° out of phase and a 4-phase system should be spaced 90°.

The phase detector is an edge-sensitive digital type that provides a known phase shift between the external and internal oscillators. This type of phase detector does not exhibit false lock to harmonics of the external clock.

The output of the phase detector is a pair of complementary current sources that charge or discharge the internal filter network. The PLL lock range is guaranteed between 200kHz and 1MHz. Nominal parts will have a range beyond this; however, operation to a wider frequency range is not guaranteed.

The PLL has a lock detection circuit. If the PLL should lose lock during operation, bit 4 of the STATUS_MFR_SPECIFIC command is asserted and the $\overline{\text{ALERT}}$ pin is pulled low. The fault can be cleared by writing a 1 to the bit. If the user does not wish to see the $\overline{\text{ALERT}}$ pin assert if a PLL_FAULT occurs, the SMBALERT_MASK command can be used to prevent the alert.

If the SYNC signal is not clocking in the application, the nominal programmed frequency will control the PWM circuitry. However, if multiple parts share the SYNC pins and the signal is not clocking, the parts will not be synchronized and excess voltage ripple on the output may be present. Bit 10 of MFR_PADS will be asserted low if this condition exists.

If the PWM signal appears to be running at too high a frequency, monitor the SYNC pin. Extra transitions on the falling edge will result in the PLL trying to lock on to noise versus the intended signal. Review routing of digital control signals and minimize crosstalk to the SYNC

DUAL 25A PSM APPLICATIONS INFORMATION

signal to avoid this problem. Multiple LTM4664s PSM sections are required to share one SYNC pin in PolyPhase configurations. For other configurations, connecting the SYNC pins to form a single SYNC signal is optional. If the SYNC pin is shared between LTM4664s PSM sections, only one LTM4664 section can be programmed with a frequency output. All the other LTM4664s sections should be programmed to disable the SYNC output. However their frequency should be programmed to the nominal desired value. See application schematic in Figure 51.

INPUT CURRENT SENSE AMPLIFIER

The LTM4664 input current sense amplifier can sense the supply current into the V_{INS3_CN} power stages pins using an external sense resistor as shown in the Figure 2 Block Diagram. The R_{SENSE} value can be programmed using the `MFR_IIN_CAL_GAIN` command. Kelvin sensing is recommended across the R_{SENSE} resistor to eliminate errors. The `MFR_PWM_CONFIG [6:5]` sets the input current sense amplifier gain. See the `MFR_PWM_CONFIG` section. The `IIN_OC_WARN_LIMIT` command sets the value of the input current measured by the ADC, in amperes, that causes a warning indicating the input current is high. The `READ_IIN` value will be used to determine if this limit has been exceeded. The `READ_IIN` command returns the input current, in Amperes, as measured across the input current sense resistor.

There is an IR voltage drop from the supply to the V_{INS3} controller pin due to the current flowing into the V_{INS3} controller pin. To compensate for this voltage drop, the `MFR_RVIN` will be automatically set to the 1Ω internal sense resistor in the Figure 2 Block Diagram. The LTM4664 PSM will multiply the `MFR_READ_ICHIP` measurement value by this 1Ω resistor and add this voltage to the measured voltage at the V_{INS3} controller pin. Therefore, $READ_VIN = V_{IN_CNTLPIN} + (MFR_READ_ICHIP \cdot 1\Omega)$. The `MFR_READ_ICHIP` command is used to measure the internal controller current. Using the `READ_PIN` command allows for reading calculated input power.

PROGRAMMABLE LOOP COMPENSATION

The LTM4664 offers programmable loop compensation to optimize the transient response without any hardware change. The error amplifier gain g_m varies from $1.0m\Omega$ to $5.73m\Omega$, and the compensation resistor R_{COMP} varies from $0k\Omega$ to $62k\Omega$ inside the controller. Two compensation capacitors, $COMP_{na}$ and $COMP_{nb}$, are required in the design and the typical ratio between $COMP_{na}$ and $COMP_{nb}$ is 10. Also see Figure 2 Block Diagram, and Figure 31.

By adjusting the g_m and R_{COMP} only, the LTM4664 PSM can provide a flexible Type II compensation network to optimize the loop over a wide range of output capacitors. Adjusting the g_m will change the gain of the compensation over the whole frequency range without moving the pole and zero location, as shown in Figure 32.

Adjusting the R_{COMP} will change the pole and zero location, as shown in Figure 33. It is recommended that the user determines the appropriate value for the g_m and R_{COMP} using the LTpowerCAD tool.

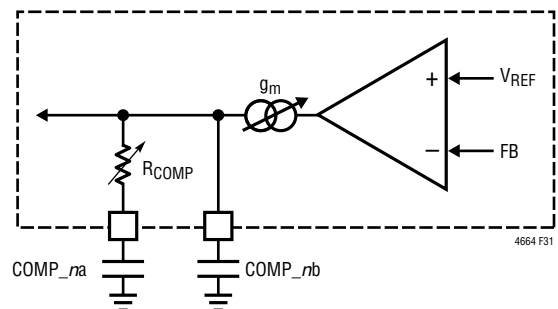

Figure 31. Programmable Loop Compensation

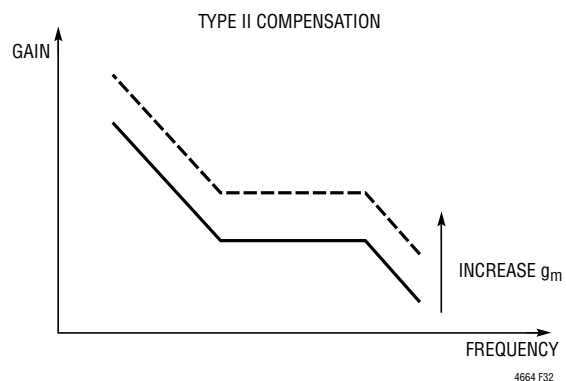

Figure 32. Error Amp g_m Adjust

DUAL 25A PSM APPLICATIONS INFORMATION

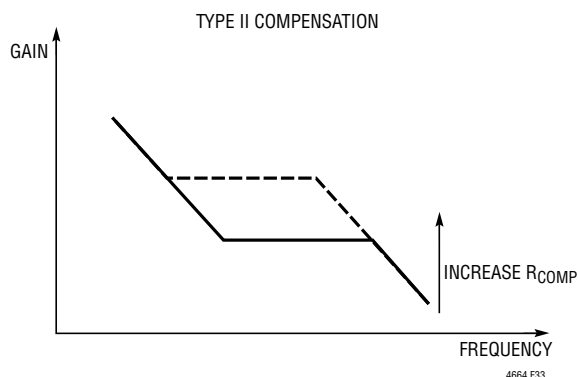

Figure 33. R_{COMP} Adjust

CHECKING TRANSIENT RESPONSE

The regulator loop response can be checked by looking at the load current transient response. Switching regulators take several cycles to respond to a step in DC (resistive) load current. When a load step occurs, V_{OUT} shifts by an amount equal to $\Delta I_{LOAD}(ESR)$, where ESR is the effective series resistance of C_{OUT} . ΔI_{LOAD} also begins to charge or discharge C_{OUT} generating the feedback error signal that forces the regulator to adapt to the current change and return V_{OUT} to its steady-state value. During this recovery time V_{OUT} can be monitored for excessive overshoot or ringing, which would indicate a stability problem. The availability of the COMP pin not only allows optimization of control loop behavior but also provides a DC-coupled and AC-filtered closed-loop response test point. The DC step, rise time and settling at this test point truly reflects the closed-loop response. Assuming a predominantly second order system, phase margin and/or damping factor can be estimated using the percentage of overshoot seen at this pin. The bandwidth can also be estimated by examining the rise time at the pin. The COMP_C_{na} external capacitor shown in the Typical Application circuit will provide an adequate starting point for most applications. The programmable parameters that affect loop gain are the voltage range, bit[1] of the MFR_PWM_CONFIG command, the current range bit[7] of the MFR_PWM_MODE command, the g_m of the PWM channel amplifier bits [7:5] of MFR_PWM_COMP, and the internal R_{COMP} compensation resistor, bits[4:0] of MFR_PWM_COMP. Be sure to establish these settings prior to compensation calculation.

The COMP_C_{na} series internal R_{COMP} and external C_{COMP_Cna} filter sets the dominant pole-zero loop compensation. The internal R_{COMP} value can be modified (from 0Ω to 62kΩ) using bits[4:0] of the MFR_PWM_COMP command. Adjust the value of R_{COMP} to optimize transient response once the final PCB layout is done and the particular C_{COMP_bn} filter capacitor and output capacitor type and value have been determined. The output capacitors need to be selected because the various types and values determine the loop gain and phase. An output current pulse of 20% to 80% of full-load current having a rise time of 1μs to 10μs will produce output voltage and COMP pin waveforms that will give a sense of the overall loop stability without breaking the feedback loop. Placing a power MOSFET with a resistor to ground directly across the output capacitor and driving the gate with an appropriate signal generator is a practical way to produce to a load step. The MOSFET + R_{SERIES} will produce output currents approximately equal to V_{OUT}/R_{SERIES} . R_{SERIES} values from 0.1Ω to 2Ω are valid depending on the current limit settings and the programmed output voltage. The initial output voltage step resulting from the step change in output current may not be within the bandwidth of the feedback loop, so this signal cannot be used to determine phase margin. This is why it is better to look at the COMP pin signal which is in the feedback loop and is the filtered and compensated control loop response. The gain of the loop will be increased by increasing R_{COMP} and the bandwidth of the loop will be increased by decreasing C_{COMP_Cna}. If R_{COMP} is increased by the same factor that C_{COMP} is decreased, the zero frequency will be kept the same, thereby keeping the phase shift the same in the most critical frequency range of the feedback loop. The gain of the loop will be proportional to the transconductance of the error amplifier which is set using bits[7:5] of the MFR_PWM_COMP command. The output voltage settling behavior is related to the stability of the closed-loop system and will demonstrate the actual overall supply performance. A second, more severe transient is caused by switching in loads with large (>1μF) supply bypass capacitors. The discharged bypass capacitors are effectively put in parallel with C_{OUT}, causing a rapid drop in V_{OUT} . No regulator can alter its delivery of current quickly enough to prevent this sudden step change in output

DUAL 25A PSM APPLICATIONS INFORMATION

voltage if the load switch resistance is low and it is driven quickly. If the ratio of C_{LOAD} to C_{OUT} is greater than 1:50, the switch rise time should be controlled so that the load rise time is limited to approximately $25 \cdot C_{LOAD}$. Thus a $10\mu\text{F}$ capacitor would require a $250\mu\text{s}$ rise time, limiting the charging current to about 200mA.

PolyPhase® Configuration

When configuring a PolyPhase rail with multiple LTM4664s, the user must share the SYNC, COMP_{na}, COMP_{nb} SHARE_CLK, FAULT_{Cn}, and ALERT pins of these parts. Be sure to use pull-up resistors on FAULT_{Cn}, SHARE_CLK and ALERT. One of the part's SYNC pins must be set to the desired switching frequency, and all other FREQUENCY_SWITCH commands must be set to External Clock. If an external oscillator is provided, set the FREQUENCY_SWITCH command to External Clock for all parts. The relative phasing of all the channels should be spaced equally. The MFR_RAIL_ADDRESS of all the devices should be set to the same value.

Multiple channels need to tie all the V_{OSNS}^+ pins together, and all the V_{OSNS}^- pins together COMP_{na} and COMP_{nb} pins together as well. Do not assert bit[4] of MFR_CONFIG_ALL except in a PolyPhase application. See application example Figure 50.

CONNECTING THE USB TO I²C/SMBUS/PMBUS CONTROLLER TO THE LTM4664 IN-SYSTEM

The ADI USB-to-I²C/SMBus/PMBus adapter (DC1613A or equivalent) can be interfaced to the LTM4664 PSM on the user's board for programming, telemetry and system debug. The adapter, when used in conjunction with LTpowerPlay, provides a powerful way to debug an entire power system. Faults are quickly diagnosed using telemetry, fault status commands and the fault log. The final configuration can be quickly developed and stored to the LTM4664 PSM EEPROM. Figure 34 illustrates the application schematic for powering, programming and communication with one or more LTM4664s PSM via the ADI I²C/SMBus/PMBus adapter regardless of whether or not system power is present. If system power is not present, the dongle will power the LTM4664 PSM through the V_{DD33} supply pin. To initialize the part when V_{IN} is not applied and the V_{DD33} pin is powered, use global address 0x5B command 0xBD data 0x2B followed by address 0x5B command 0xBD data 0xC4. The LTM4664 PSM can now communicate with, and the project file Figure 34. Controller Connection can be updated. To write the updated project file to the NVM issue a STORE_USER_ALL command. When V_{IN} is applied, a MFR_RESET must be issued to allow the PWM POWER to be enabled and valid ADCs to be read.

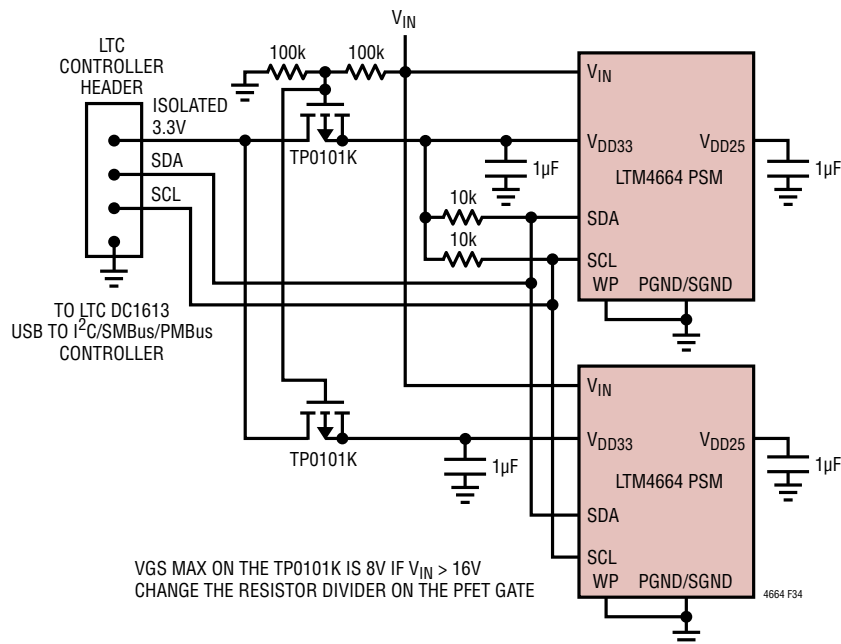

Figure 34. Controller Connection

DUAL 25A PSM APPLICATIONS INFORMATION

Because of the adapter's limited current sourcing capability, only the LTM4664s, PSM their associated pull-up resistors and the I²C pull-up resistors should be powered from the ORed 3.3V supply. In addition any device sharing the I²C bus connections with the LTM4664 PSM should not have body diodes between the SDA/SCL pins and their respective V_{DD} node because this will interfere with bus communication in the absence of system power. If V_{INS3} is applied, the DC1613A will not supply the power to the LTM4664s PSM on the board. It is recommended the RUN_Cn pins be held low or no voltage configuration resistors inserted to avoid providing power to the load until the part is fully configured.

The LTM4664 PSM is fully isolated from the host PC's ground by the DC1613A. The 3.3V from the adapter and the LTM4664 V_{DD33} pin must be driven to each LTM4664 with a separate PFET. If both V_{INS3} and EXTV_{CC} are not applied, the V_{DD33} pins can be in parallel because the on-chip LDO is off. The controller 3.3V current limit is 100mA but typical V_{DD33} currents are under 15mA. The V_{DD33} does back drive the INTV_{CC}/EXTV_{CC} pin. Normally this is not an issue if V_{IN} is open.

LTpowerPlay: AN INTERACTIVE GUI FOR DIGITAL POWER

LTpowerPlay (Figure 35) is a powerful Windows-based development environment that supports Linear Technology digital power system management ICs including the LTM4664 PSM section. The software supports a variety of different tasks. LTpowerPlay can be used to evaluate Linear Technology ICs by connecting to a demo board or the user application. LTpowerPlay can also be used in an offline mode (with no hardware present) in order to build multiple IC configuration files that can be saved and reloaded at a later time. LTpowerPlay provides unprecedented diagnostic and debug features. It becomes a valuable diagnostic tool during board bring-up to program or tweak the power system or to diagnose power issues when bring up rails. LTpowerPlay utilizes Linear Technology's USB-to-I²C/SMBus/PMBus adapter to communication with one of the many potential targets including the DC2165A demo board, the DC2298A socketed

programming board, or a customer target system. The software also provides an automatic update feature to keep the revisions current with the latest set of device drivers and documentation.

A great deal of context sensitive help is available with LTpowerPlay along with several tutorial demos. Complete information is available at:

[ltpowerplay](#)

PMBus COMMUNICATION AND COMMAND PROCESSING

The LTM4664 PSM has a one deep buffer to hold the last data written for each supported command prior to processing as shown in Figure 36, Write Command Data Processing. When the part receives a new command from the bus, it copies the data into the Write Command Data Buffer, indicates to the internal processor that this command data needs to be fetched, and converts the command to its internal format so that it can be executed. Two distinct parallel blocks manage command buffering and command processing (fetch, convert, and execute) to ensure the last data written to any command is never lost. Command data buffering handles incoming PMBus writes by storing the command data to the Write Command Data Buffer and marking these commands for future processing. The internal processor runs in parallel and handles the sometimes slower task of fetching, converting and executing commands marked for processing. Some computationally intensive commands (e.g., timing parameters, temperatures, voltages and currents) have internal processor execution times that may be long relative to PMBus timing. If the part is busy processing a command, and new command(s) arrive, execution may be delayed or processed in a different order than received. The part indicates when internal calculations are in process via bit 5 of MFR_COMMON ("calculations not pending"). When the part is busy calculating, bit 5 is cleared. When this bit is set, the part is ready for another command. An example polling loop is provided in Figure 37 which ensures that commands are processed in order while simplifying error handling routines.

DUAL 25A PSM APPLICATIONS INFORMATION

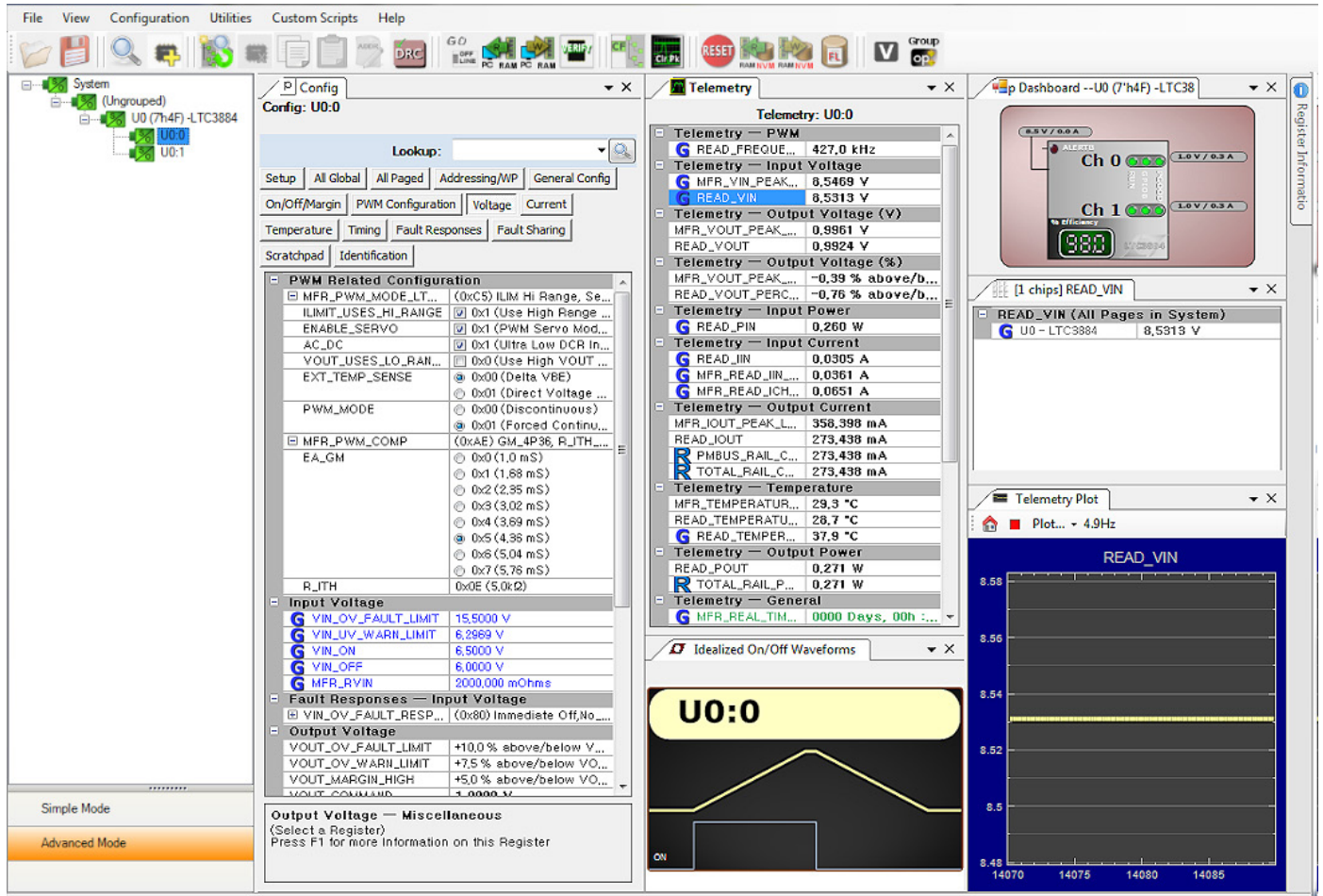

Figure 35. LTpowerPlay Screen Shot

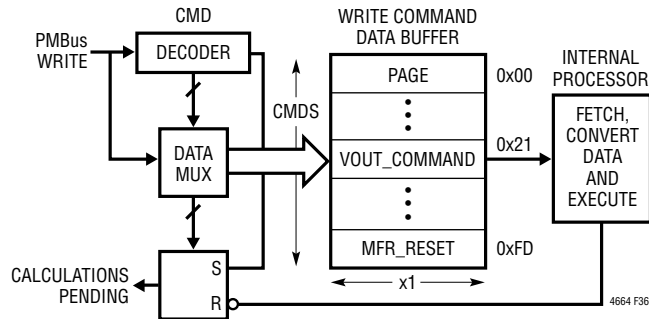

Figure 36. Write Command Data Processing

DUAL 25A PSM APPLICATIONS INFORMATION

When the part receives a new command while it is busy, it will communicate this condition using standard PMBus protocol. Depending on part configuration it may either NACK the command or return all ones (0xFF) for reads. It may also generate a BUSY fault and $\overline{\text{ALERT}}$ notification, or stretch the SCL clock low. For more information refer to PMBus Specification v1.1, Part II, Section 10.8.7 and SMBus v2.0 section 4.3.3. Clock stretching can be enabled by asserting bit 1 of MFR_CONFIG_ALL. Clock stretching will only occur if enabled and the bus communication speed exceeds 100kHz.

```
// wait until chip is not busy
do
{
mfrCommonValue = PMBUS_READ_BYTE(0xEF);
partReady = (mfrCommonValue & 0x68) == 0x68;
}while(!partReady)

// now the part is ready to receive the next
command
PMBUS_WRITE_WORD(0x21, 0x2000); //write VOUT_
COMMAND to 2V
```

Figure 37. Example of a Command Write of VOUT_COMMAND

PMBus busy protocols are well accepted standards, but can make writing system level software somewhat complex. The part provides three ‘hand shaking’ status bits which reduce complexity while enabling robust system level communication.

The three hand shaking status bits are in the MFR_COMMON register. When the part is busy executing an internal operation, it will clear bit 6 of MFR_COMMON (‘chip not busy’). When the part is busy specifically because it is in a transitional V_{OUT} state (margining hi/lo, power off/on, moving to a new output voltage set point, etc.) it will clear bit 4 of MFR_COMMON (‘output not in transition’). When internal calculations are in process, the part will clear bit 5 of MFR_COMMON (‘calculations not pending’). These three status bits can be polled with a PMBus read byte of the MFR_COMMON register until all three bits are set. A command immediately following the status bits being set will be accepted without NACKing or generating a BUSY fault/ALERT notification. The part can NACK commands for other reasons, however, as required by the PMBus spec (for instance, an invalid command or data). An example of a robust command write algorithm for the VOUT_COMMAND register is provided in Figure 33.

It is recommended that all command writes (write byte, write word, etc.) be preceded with a polling loop to avoid the extra complexity of dealing with busy behavior and unwanted ALERT notification. A simple way to achieve this is to create a SAFE_WRITE_BYTE() and SAFE_WRITE_WORD() subroutine. The above polling mechanism allows your software to remain clean and simple while robustly communicating with the part. For a detailed discussion of these topics and other special cases please refer to the Analog Devices Application Notes.

When communicating using bus speeds at or below 100kHz, the polling mechanism shown here provides a simple solution that ensures robust communication without clock stretching. At bus speeds in excess of 100kHz, it is strongly recommended that the part be configured to enable clock stretching. This requires a PMBus master that supports clock stretching. System software that detects and properly recovers from the standard PMBus NACK/BUSY faults as described in the PMBus Specification v1.1, Par II, Section 10.8.7 is required to communicate. The LTM4664 PSM is not recommended in applications with bus speeds in excess of 400kHz.

THERMAL CONSIDERATIONS AND OUTPUT CURRENT DERATING

The thermal resistances reported in the Pin Configuration section of this data sheet are consistent with those parameters defined by JESD51-12 and are intended for use with finite element analysis (FEA) software modeling tools that leverage the outcome of thermal modeling, simulation, and correlation to hardware evaluation performed on a μ Module package mounted to a hardware test board defined by JESD51-9 (‘Test Boards for Area Array Surface Mount Package Thermal Measurements’). The motivation for providing these thermal coefficients is found in JESD51-12 (‘Guidelines for Reporting and Using Electronic Package Thermal Information’).

Many designers may opt to use laboratory equipment and a test vehicle such as the demo board to predict the μ Module regulator’s thermal performance in their application at various electrical and environmental operating conditions to compliment any FEA activities. Without FEA software, the thermal resistances reported in the

DUAL 25A PSM APPLICATIONS INFORMATION

Pin Configuration section are in-and-of themselves not relevant to providing guidance of thermal performance; instead, the derating curves provided later in this data sheet can be used in a manner that yields insight and guidance pertaining to one's application-usage, and can be adapted to correlate thermal performance to one's own application.

The Pin Configuration section gives four thermal coefficients explicitly defined in JESD51-12; these coefficients are quoted or paraphrased below:

1. θ_{JA} , the thermal resistance from junction to ambient, is the natural convection junction-to-ambient air thermal resistance measured in a one cubic foot sealed enclosure. This environment is sometimes referred to as "still air" although natural convection causes the air to move. This value is determined with the part mounted to a JESD51-9 defined test board, which does not reflect an actual application or viable operating condition.
2. $\theta_{JCbottom}$, the thermal resistance from junction to the bottom of the product case, is determined with all of the component power dissipation flowing through the bottom of the package. In the typical μ Module regulator, the bulk of the heat flows out the bottom of the package, but there is always heat flow out into the ambient environment. As a result, this thermal resistance value may be useful for comparing packages but the test conditions don't generally match the user's application.
3. θ_{JCtop} , the thermal resistance from junction to top of the product case, is determined with nearly all of the component power dissipation flowing through the top of the package. As the electrical connections of the typical μ Module regulator are on the bottom of the package, it is rare for an application to operate such that most of the heat flows from the junction to the top of the part. As in the case of $\theta_{JCbottom}$, this value may be useful for comparing packages but the test conditions don't generally match the user's application.
4. θ_{JB} , the thermal resistance from junction to the printed circuit board, is the junction-to-board thermal resistance where almost all of the heat flows through the bottom of the μ Module regulator and into the board, and is really the sum of the $\theta_{JCbottom}$ and the thermal resistance of the bottom of the part through the solder joints and through a portion of the board. The board temperature is measured a specified distance from the package, using a two sided, two layer board. This board is described in JESD51-9.

A graphical representation of the aforementioned thermal resistances is given in Figure 38; blue resistances are contained within the μ Module regulator, whereas green resistances are external to the μ Module package.

As a practical matter, it should be clear to the reader that no individual or sub-group of the four thermal resistance parameters defined by JESD51-12 or provided in the Pin

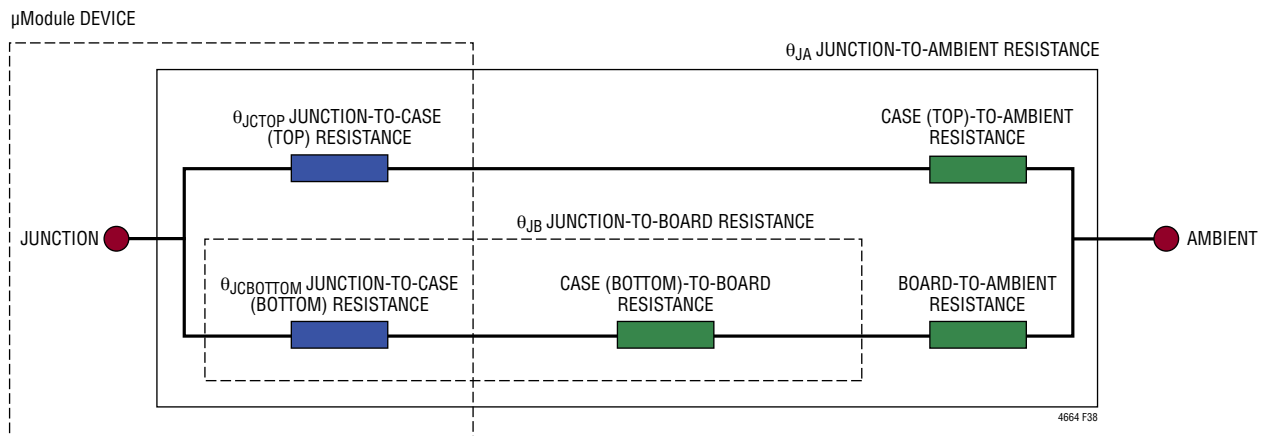

Figure 38. Graphical Representation of JESD51-12 Thermal Coefficients

DUAL 25A PSM APPLICATIONS INFORMATION

Configuration section replicates or conveys normal operating conditions of a μ Module regulator. For example, in normal board-mounted applications, never does 100% of the device's total power loss (heat) thermally conduct exclusively through the top or exclusively through the bottom of the μ Module package—as the standard defines for θ_{JCtop} and $\theta_{JCbottom}$, respectively. In practice, power loss is thermally dissipated in both directions away from the package—granted, in the absence of a heat sink and airflow, a majority of the heat flow is into the board.

Within the LTM4664, be aware there are multiple power devices and components dissipating power, with a consequence that the thermal resistances relative to different junctions of components or die are not exactly linear with respect to total package power loss. To reconcile this complication without sacrificing modeling simplicity—but also, not ignoring practical realities—an approach has been taken using FEA software modeling along with laboratory testing in a controlled-environment chamber to reasonably define and correlate the thermal resistance values supplied in this data sheet: (1) Initially, FEA software is used to accurately build the mechanical geometry of the LTM4664 and the specified PCB with all of the correct material coefficients along with accurate power loss source definitions; (2) this model simulates a software-defined JEDEC environment consistent with JESD51-9 and JESD51-12 to predict power loss heat flow and temperature readings at different interfaces that enable the calculation of the JEDEC-defined thermal resistance values; (3) the model and FEA software is used to evaluate the LTM4664 with heat sink and airflow; (4) having solved for and analyzed these thermal resistance values and simulated various operating conditions in the software model, a thorough laboratory evaluation replicates the simulated conditions with thermocouples within a controlled environment chamber while operating the device at the same power loss as that which was simulated. The outcome of this process and due diligence yields the set of derating curves provided in later sections of this data sheet, along with well-correlated JESD51-12-defined θ values provided in the Pin Configuration section of this data sheet.

The 1.0V and 1.5V power loss curves in Figure 39 and 40 respectively can be used in coordination with the load current derating curves in Figure 41 to 44 for calculating an approximate θ_{JA} thermal resistance for the LTM4664 with various heat sinking and airflow conditions. These thermal resistances represent demonstrated performance of the LTM4664 on hardware; a 8-layer FR4 PCB measuring 99mm \times 145mm \times 1.6mm using 2oz copper on all layers. The power loss curves are taken at room temperature, and are increased with multiplicative factors of 1.35 when the junction temperature reaches 125°C. The derating curves are plotted with the LTM4664's paralleled outputs initially sourcing up to 50A and the ambient temperature at 50°C. The output voltages are 1.0V and 1.5V. These are chosen to include the lower and higher output voltage ranges for correlating the thermal resistance. Thermal models are derived from several temperature measurements in a controlled temperature chamber along with thermal modeling analysis. The junction temperatures are monitored while ambient temperature is increased with and without airflow.

The power loss increase with ambient temperature change is factored into the derating curves. The junctions are maintained at 125°C maximum while lowering output current or power while increasing ambient temperature. The decreased output current decreases the internal module loss as ambient temperature is increased. The monitored junction temperature of 120°C minus the ambient operating temperature specifies how much module temperature rise can be allowed. As an example in Figure 41, the load current is derated to ~30A at ~97°C ambient with no air or heat sink and the room temperature (25°C) power loss for this 48V_{IN} to 1.0V_{OUT} at 30A_{OUT} condition is ~3.2W. A 4.32W loss is calculated by multiplying the ~3.2W room temperature loss from the 48V_{IN} to 1.0V_{OUT} power loss curve at 30A (Figure 41), with the 1.35 multiplying factor. If the 97°C ambient temperature is subtracted from the 120°C junction temperature, then the difference of 23°C divided by 4.32W yields a thermal resistance, θ_{JA} , of 5.3°C/W—in good agreement with Table 11. Table 10 and 11 provide equivalent thermal resistances for 1.0V and 1.5V outputs with and without airflow. The derived

DUAL 25A PSM APPLICATIONS INFORMATION

thermal resistances in Table 10 and Table 11 are for the various conditions can be multiplied by the calculated power loss as a function of ambient temperature to derive temperature rise above ambient, thus maximum

junction temperature. Room temperature power loss can be derived from the efficiency curves in the Typical Performance Characteristics section and adjusted with the above ambient temperature multiplicative factors.

TABLE 10 AND TABLE 11: OUTPUT CURRENT DERATING (BASED ON DEMO BOARD)

Table 10. 1.0V Output

DERATING CURVE	V _{IN} (V)	POWER LOSS CURVE	AIRFLOW (LFM)	HEAT SINK	θ _{JA} (°C/W)
Figure 41, 42	48, 54	Figure 39, 40	0	None	5.3
Figure 41, 42	48, 54	Figure 39, 40	200	None	4.5
Figure 41, 42	48, 54	Figure 39, 40	400	None	4.0

Table 11. 1.5V Output

DERATING CURVE	V _{IN} (V)	POWER LOSS CURVE	AIRFLOW (LFM)	HEAT SINK	θ _{JA} (°C/W)
Figure 43, 44	48, 54	Figure 39, 40	0	None	5.3
Figure 43, 44	48, 54	Figure 39, 40	200	None	4.5
Figure 43, 44	48, 54	Figure 39, 40	400	None	4.0

DUAL 25A PSM APPLICATIONS INFORMATION

Table 12. LTM4664 Dual 25A PSM Output Capacitor Matrix
All Below Parameters are Typical and Are Dependent on Board Layout

Murata	220 μ F 6.3V	GRM32ER60J227ME05	PANASONIC SP-CAP	470 μ F 2.5V	EEFSX0E471E4
Taiyo Yuden	220 μ F 4V	AMK325ABJ227MMHT	PANASONIC POSCAP	470 μ F 2.5V	ETPF470M5H
Murata	100 μ F 6.3V	GRM32ER60J107M	PANASONIC POSCAP	1000 μ F 2.5V	
Murata	100 μ F 4V	GRM21BR60G107ME15	PANASONIC POSCAP	1000 μ F 2.5V	ETCF1000M5H
Taiyo Yuden	100 μ F 4V	AMK325AD7MMHP			

Single 25A Output						Programmed Values										
V _{OUT} (V)	C _{OUT1} (CERAMIC) (μ F)	C _{OUT2} (BULK) (μ F)	COMP _{ra} (pF)	COMP _{rb} (pF)	EA-GM (ms)	R _{COMP} (k Ω)	I _{LIM} HI-RANGE	V _{OUT} LOW-RANGE	V _{INS1} (V)	V _{INS3} C1, C2	DROOP (mV)	PEAK-TO-PEAK DEVIATION (mV)	RECOVERY TIME(μ s) LTpowerCAD/ MEASURE	LOAD STEP (A/ μ s)	FREQ. (kHz)	
0.9	5 \times 100	2 \times 470	2200	100	3.69	5	Yes	Yes	48	(V _{INS1/4}) or 12V	42.5	85	36	12.5	250	
0.9	5 \times 100	1 \times 1000	3300	220	3.02	5	Yes	Yes	48	(V _{INS1/4}) or 12V	55.5	111	40	12.5	250	
0.9	6 \times 220	None	4700	100	3.69	4	Yes	Yes	48	(V _{INS1/4}) or 12V	75	150	50	12.5	250	
1	5 \times 100	2 \times 470	2200	100	3.69	5	Yes	Yes	48	(V _{INS1/4}) or 12V	42.5	85	36	12.5	250	
1	5 \times 100	1 \times 1000	3300	220	3.02	5	Yes	Yes	48	(V _{INS1/4}) or 12V	56	112	40	12.5	250	
1	6 \times 220	None	4700	100	3.69	4	Yes	Yes	48	(V _{INS1/4}) or 12V	75	150	50	12.5	250	
1.2	3 \times 100	1 \times 470	2200	220	3.69	3	Yes	Yes	48	(V _{INS1/4}) or 12V	67.5	135	27	12.5	350	
1.2	3 \times 100	1 \times 470	2200	220	3.69	4	Yes	Yes	48	(V _{INS1/4}) or 12V	60	120	27	12.5	350	
1.2	3 \times 220	None	2200	220	1.68	5	Yes	Yes	48	(V _{INS1/4}) or 12V	85	170	20	12.5	350	
1.2	1 \times 100	1 \times 470	2200	220	3.02	6	Yes	Yes	48	(V _{INS1/4}) or 12V	68	136	33	12.5	350	
1.5	3 \times 220	None	2200	220	1.68	5	Yes	Yes	48	(V _{INS1/4}) or 12V	115	230	30	12.5	350	
1.5	1 \times 100	1 \times 470	2200	220	3.02	6	Yes	Yes	48	(V _{INS1/4}) or 12V	70	140	27	12.5	350	

DUAL 25A PSM APPLICATIONS INFORMATION

Table 13. LTM4664 Dual 25A PSM Output Capacitor Matrix. All Below Parameters Are Typical and Are Dependent on Board Layout

Murata	220 μ F 6.3V	GRM32ER60J227ME05	PANASONIC SP-CAP	470 μ F 2.5V EEFSX0E471E4
Taiyo Yuden	220 μ F 4V	AMK325ABJ227MMHT	PANASONIC POSCAP	470 μ F 2.5V ETPF470M5H
Murata	100 μ F 6.3V	GRM32ER60J107M	PANASONIC POSCAP	1000 μ F 2.5V ETPF1000M5H
Murata	100 μ F 4V	GRM21BR60G107ME15	PANASONIC POSCAP	1000 μ F 2.5V ETCF1000M5H
Taiyo Yuden	100 μ F 4V	AMK325AD7MMHP		

Dual Phase Single 50A Output

V _{OUT} (V)	C _{OUT1} (CERAMIC) (μ F)	C _{OUT2} (BULK) (μ F)	COMP _{ra} (pF)	COMP _{rb} (pF)	EA-GM (ms)	R _{COMP} (k Ω)	I _{LIM} HI-RANGE	V _{OUT} LOW-RANGE	V _{INS1} (V)	V _{INS3} C1, C2	DROOP (mV)	PEAK-TO-PEAK DEVIATION (mV)	RECOVERY TIME(μ s) LTpowerCAD/MEASURE	LOAD STEP (A/ μ s)	FREQ. (kHz)
0.9	8 \times 100	4 \times 470	3300	220	3.69	8	No	Yes	48	(V _{INS1/4}) or 12V	47.5	62/95	30	25	250
1	8 \times 100	4 \times 470	3300	220	3.69	8	No	Yes	48	(V _{INS1/4}) or 12V	47.5	62/95	30	25	250
1.2	8 \times 330	None	5600	100	3.02	5	No	Yes	48	(V _{INS1/4}) or 12V	35	64	35	25	250
1.2	4 \times 100	2 \times 470	3300	220	3.02	6	No	Yes	48	(V _{INS1/4}) or 12V	70	100/140	35	25	350
1.2	4 \times 220	None	7500	220	3.02	5	No	Yes	48	(V _{INS1/4}) or 12V	63	126/-	25	25	350
1.5	4 \times 220	None	7500	220	3.02	2.5	No	Yes	48	(V _{INS1/4}) or 12V	130	260	30	25	350
1.5	6 \times 220	None	7500	220	3.69	3	No	Yes	48	(V _{INS1/4}) or 12V	100	200	30	25	350
1.5	4 \times 100	2 \times 470	3300	220	3.02	6	No	Yes	48	(V _{INS1/4}) or 12V	70	140	30	25	350
1.5	4 \times 220	None	7500	220	3.02	5	No	Yes	48	(V _{INS1/4}) or 12V	63	126	25	25	350

DUAL 25A PSM APPLICATIONS INFORMATION—DERATING CURVES

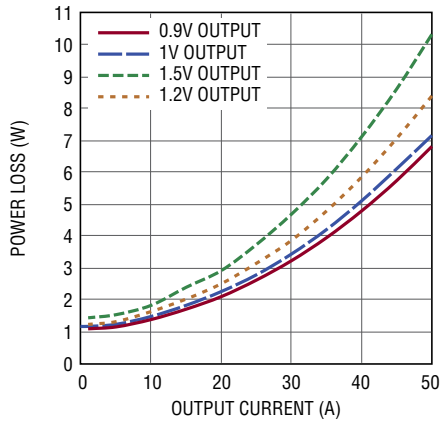

4664 F39

Figure 39. 48V Input Power Loss 2-Phase 50A Output

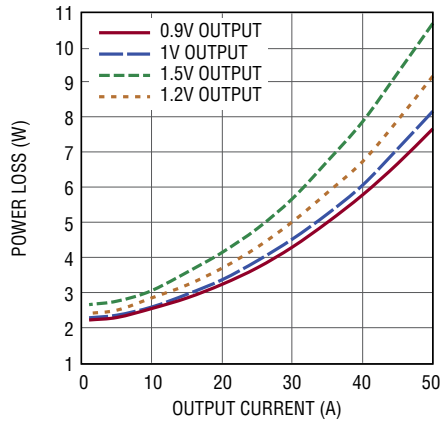

4664 F40

Figure 40. 54V Input Power Loss 2-Phase 50A Output

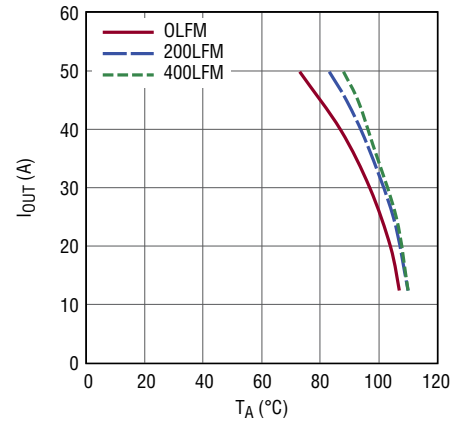

4664 F41

Figure 41. LTM4664 48V_{IN} 1V_{OUT} Derating Curve No Heat Sink

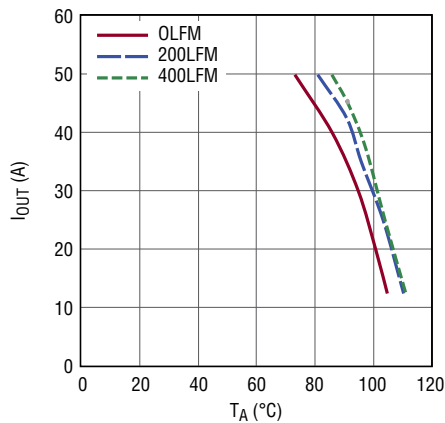

4664 F42

Figure 42. LTM4664 54V_{IN} 1V_{OUT} Derating Curve No Heat Sink

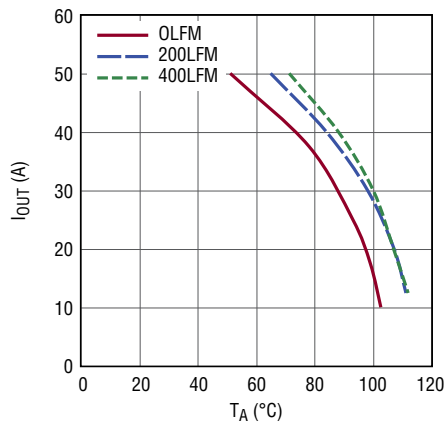

4664 F43

Figure 43. LTM4664 48V_{IN} 1.5V_{OUT} 350kHz Derating Curve No Heat Sink

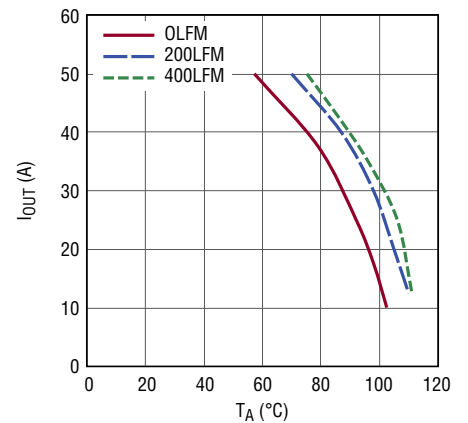

4664 F44

Figure 44. LTM4664 54V_{IN} 1.5V_{OUT} 350kHz Derating Curve No Heat Sink

DUAL 25A PSM APPLICATIONS INFORMATION

EMI PERFORMANCE

The SW_Cn pin provides access to the midpoint of the power MOSFETs in LTM4664's power stages.

Connecting an optional series RC network from SW_Cn to GND can dampen high frequency (~30MHz+) switch node ringing caused by parasitic inductances and capacitances in the switched-current paths. The RC network is called a snubber circuit because it dampens (or "snubs") the resonance of the parasitics, at the expense of higher power loss. To use a snubber, choose first how much power to allocate to the task and how much PCB real estate is available to implement the snubber. For example, if PCB space allows a low inductance 0.5W resistor to be used then the capacitor in the snubber network (C_{SW}) is computed by:

$$C_{SW} = \frac{P_{SNUB}}{V_{IN3n(MAX)}^2 \cdot f_{SW}}$$

where $V_{IN3n(MAX)}$ is the maximum input voltage that the input to the power stage (V_{INn}) will see in the application, and f_{SW} is the DC/DC converter's switching frequency of operation. C_{SW} should be NPO, COG or X7R-type (or better) material.

The snubber resistor (R_{SW}) value is then given by:

$$R_{SW} = \sqrt{\frac{5nH}{C_{SW}}}$$

The snubber resistor should be low ESL and capable of withstanding the pulsed currents present in snubber circuits. A value between 0.7Ω and 4.2Ω is normal.

A 2.2nF snubber capacitor is a good value to start with in series with the snubber resistor to ground. The no load input quiescent current can be monitored while selecting different RC series snubber components to get a increased power loss versus switch node ringing attenuation.

SAFETY CONSIDERATIONS

The LTM4664 modules do not provide galvanic isolation from V_{IN} to V_{OUT} . There is no internal fuse. If required, a slow blow fuse with a rating twice the maximum input current needs to be provided to protect each unit from catastrophic failure.

The fuse or circuit breaker should be selected to limit the current to the regulator during overvoltage in case of an internal top MOSFET fault. If the internal top MOSFET fails, then turning it off will not resolve the overvoltage, thus the internal bottom MOSFET will turn on indefinitely trying to protect the load. Under this fault condition, the input voltage will source very large currents to ground through the failed internal top MOSFET and enabled internal bottom MOSFET. This can cause excessive heat and board damage depending on how much power the input voltage can deliver to this system. A fuse or circuit breaker can be used as a secondary fault protector in this situation. The device does support over current and overtemperature protection.

DUAL 25A PSM APPLICATIONS INFORMATION

LAYOUT CHECKLIST/EXAMPLE

The high integration of LTM4664 makes the PCB board layout very simple and easy. However, to optimize its electrical and thermal performance, some layout considerations are still necessary.

- Use large PCB copper areas for high current paths, including V_{INn} , GND and V_{OUTSn} . It helps to minimize the PCB conduction loss and thermal stress.
- Place high frequency ceramic input and output capacitors next to the V_{INSn} , GND and V_{OUTn} pins to minimize high frequency noise.
- Place a dedicated power ground layer underneath the module.
- To minimize the via conduction loss and reduce module thermal stress, use multiple vias for interconnection between top layer and other power layers.
- Do not put vias directly on pads, unless they are capped or plated over.
- Use a separate SGND copper plane for components connected to signal pins. Connect SGND to GND local to the LTM4664.
- Use Kelvin sense connections across the input R_{SENSE} resistor if input current monitoring is used.
- For parallel modules, tie the V_{OUTCn} , $V_{OSNS}^+_{Cn}/V_{OSNS}^-_{Cn}$ voltage-sense differential pair lines, RUN_n , $COMP_{Cna}$, $COMP_{Cnb}$ pin together. The user must share the SYNC, SHARE_CLK, \overline{FAULT} , and \overline{ALERT} pins of these parts. Be sure to use pull-up resistors on \overline{FAULT} , SHARE_CLK and \overline{ALERT} .
- Bring out test points on the signal pins for monitoring.

Figure 45 gives a good example of the recommended layout. Reference DC2672A demo manual.

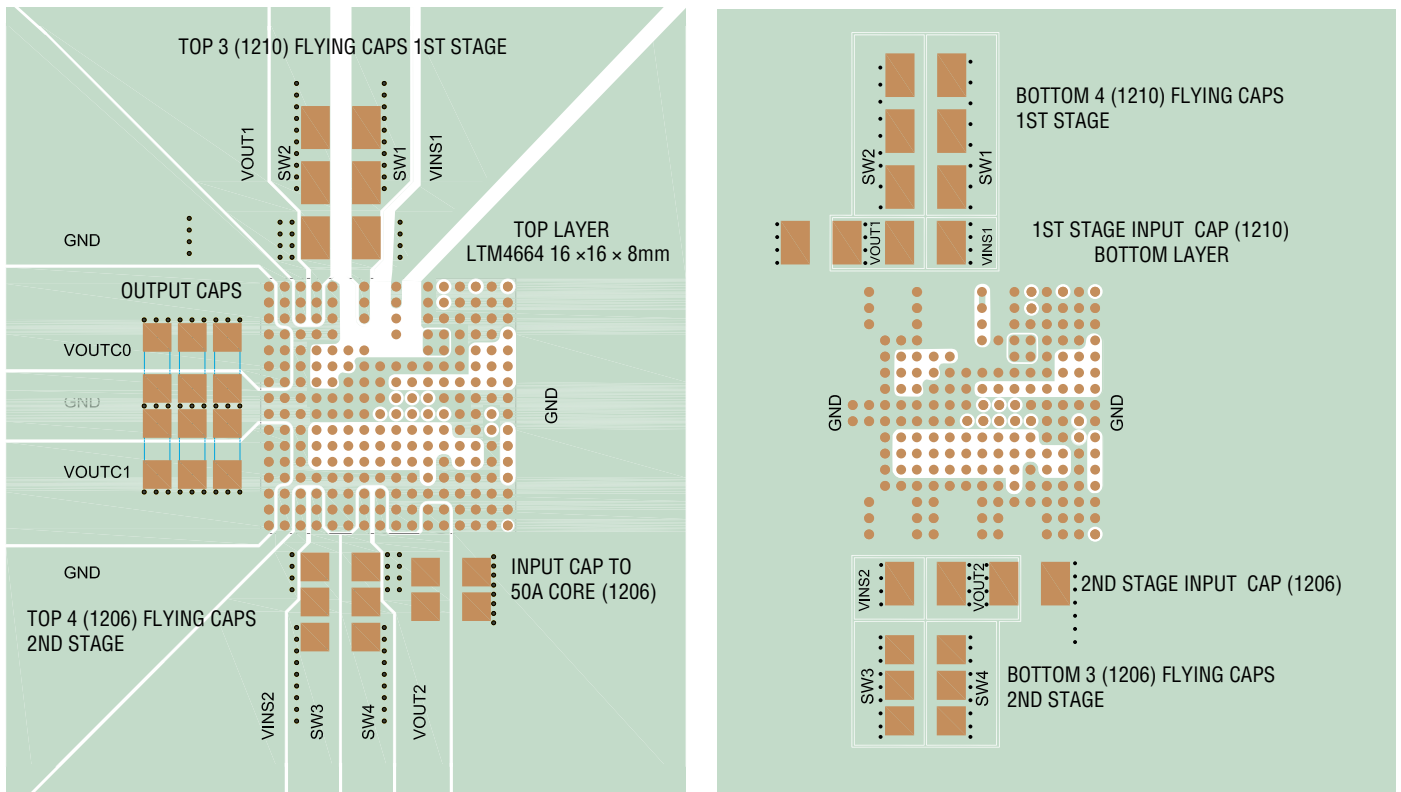

Figure 45. Recommended PCB Layout Package Top and Bottom View

TYPICAL APPLICATIONS

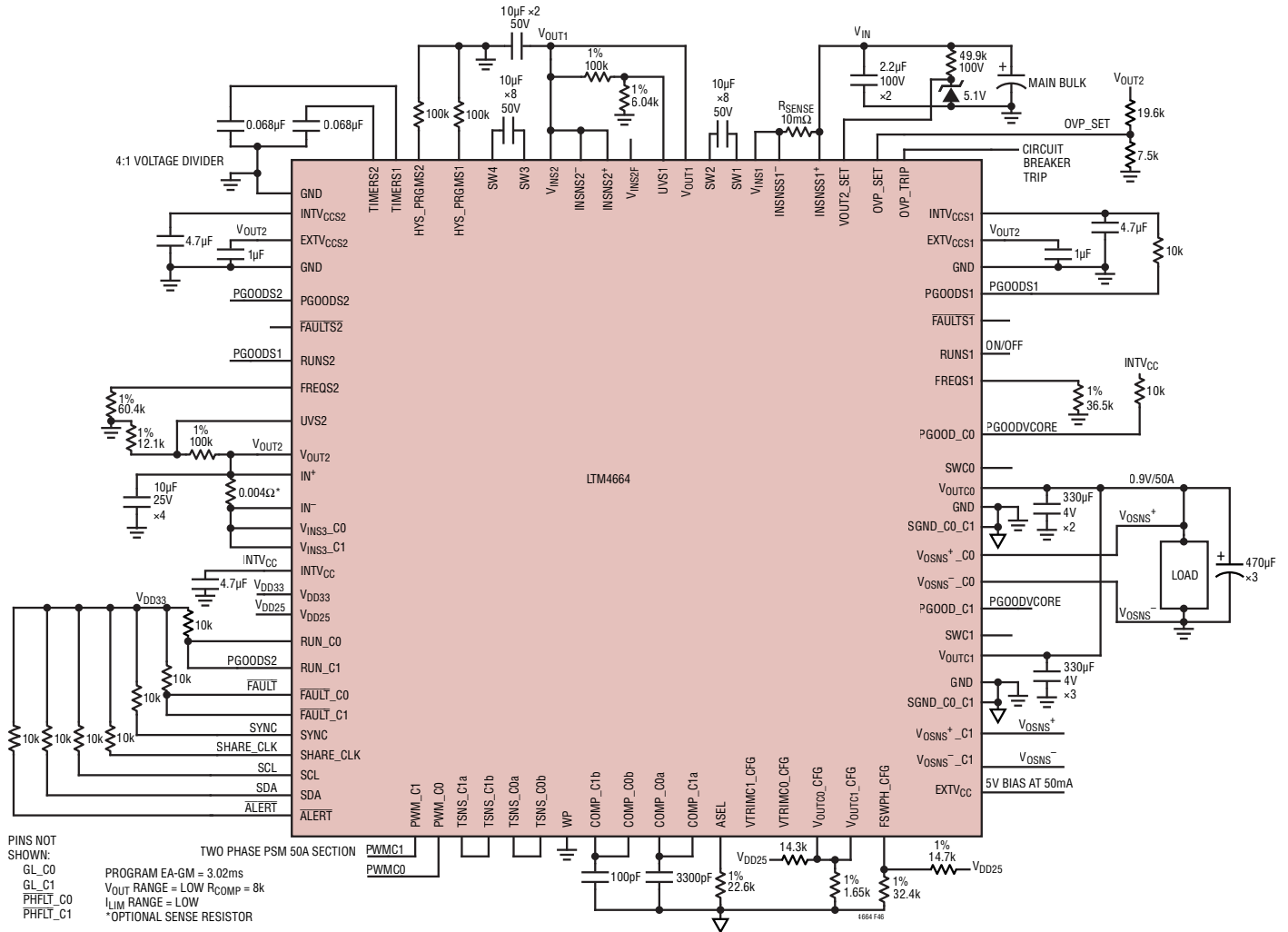

Figure 46. 0.9V at 50A Output DC/DC μ Module Regulator with I²C/SMBus/PMBus Serial Interface Including Hot Swap Front End with V_{OUT2} OVP Protection

TYPICAL APPLICATIONS

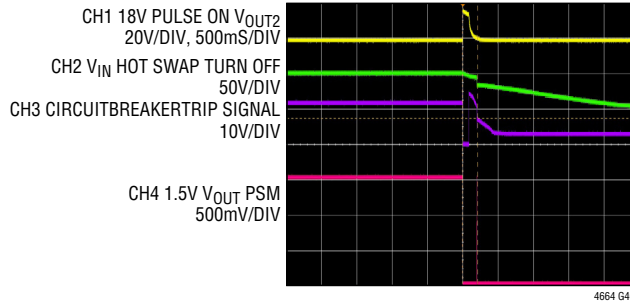

Figure 46b. V_{OUT2} Overvoltage Protection

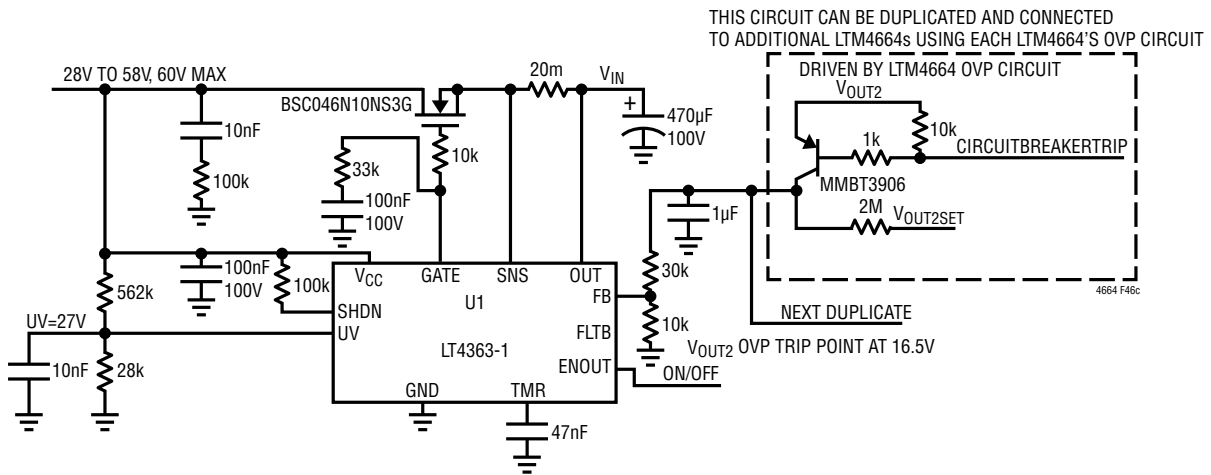

Figure 46c. Hot Swap Circuit Breaker Front End

TYPICAL APPLICATIONS

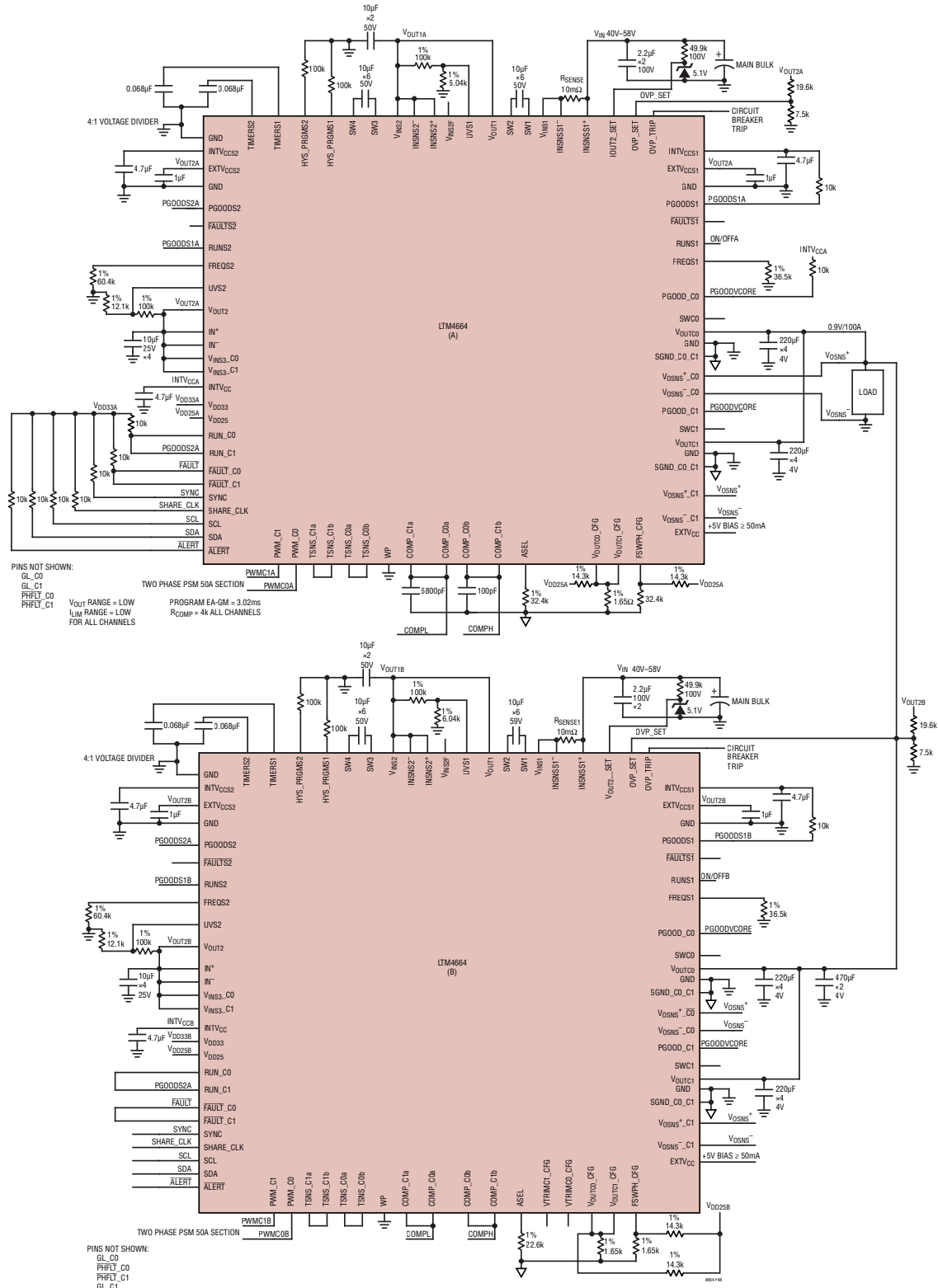

Figure 48. Two Paralleled LTM4664 Producing 54V to 0.9V_{OUT} at 100A. Integrated Power System Management Features Accessible Over 2-Wire I²C/SMBus/PMBus Serial Interface

TYPICAL APPLICATIONS

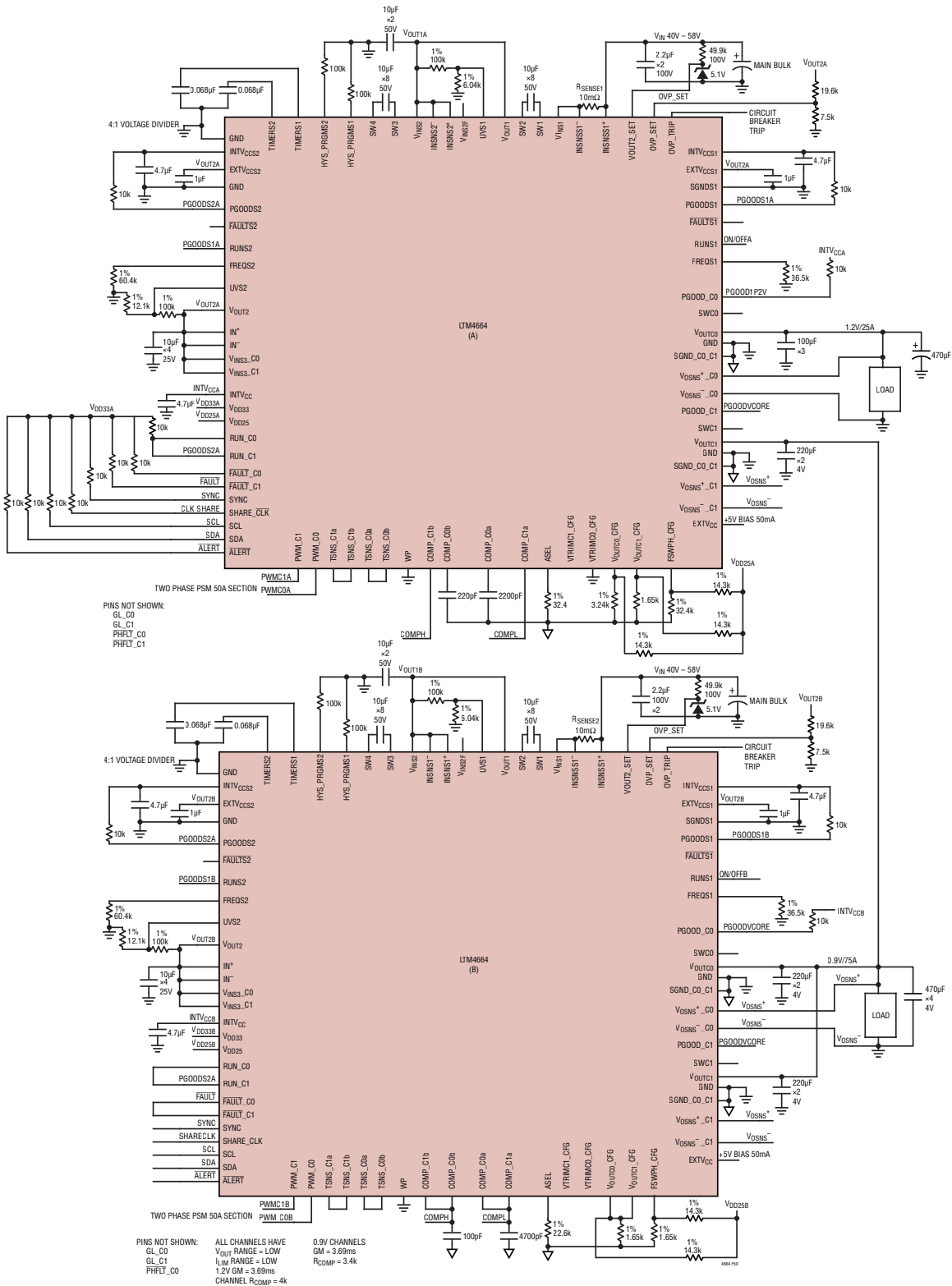

Figure 50. 48V-58V Input, Converting 1.2V at 25A, and 0.9V at 75A. Power System Management Features Accessible Through LTM4664 Over 2-Wire I²C/SMBus/PMBus Serial Interface.

PMBus COMMAND DETAILS

ADDRESSING AND WRITE PROTECT

COMMAND NAME	CMD CODE	DESCRIPTION	TYPE	PAGED	DATA FORMAT	UNITS	NVM	DEFAULT VALUE
PAGE	0x00	Provides integration with multi-page PMBus devices.	R/W Byte	N	Reg			0x00
PAGE_PLUS_WRITE	0x05	Write a supported command directly to a PWM channel.	W Block	N				
PAGE_PLUS_READ	0x06	Read a supported command directly from a PWM channel.	Block R/W	N				
WRITE_PROTECT	0x10	Level of protection provided by the device against accidental changes.	R/W Byte	N	Reg		Y	0x00
MFR_ADDRESS	0xE6	Sets the 7-bit I ² C address byte.	R/W Byte	N	Reg		Y	0x4F
MFR_RAIL_ADDRESS	0xFA	Common address for PolyPhase outputs to adjust common parameters.	R/W Byte	Y	Reg		Y	0x80

PAGE

The PAGE command provides the ability to configure, control and monitor both PWM channels through only one physical address, either the MFR_ADDRESS or GLOBAL device address. Each PAGE contains the operating commands for one PWM channel.

Pages 0x00 and 0x01 correspond to Channel 0 and Channel 1, respectively, in this device.

Setting PAGE to 0xFF applies any following paged commands to both outputs. With PAGE set to 0xFF the LTM4664 will respond to read commands as if PAGE were set to 0x00 (Channel 0 results).

This command has one data byte.

PAGE_PLUS_WRITE

The PAGE_PLUS_WRITE command provides a way to set the page within a device, send a command, and then send the data for the command, all in one communication packet. Commands allowed by the present write protection level may be sent with PAGE_PLUS_WRITE.

The value stored in the PAGE command is not affected by PAGE_PLUS_WRITE. If PAGE_PLUS_WRITE is used to send a non-paged command, the Page Number byte is ignored.

This command uses Write Block protocol. An example of the PAGE_PLUS_WRITE command with PEC sending a command that has two data bytes is shown in Figure 51.

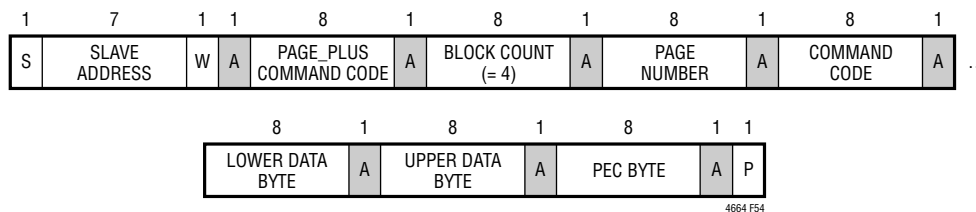

Figure 51. Example of PAGE_PLUS_WRITE

PAGE_PLUS_READ

The PAGE_PLUS_READ command provides the ability to set the page within a device, send a command, and then read the data returned by the command, all in one communication packet.

PMBus COMMAND DETAILS

The value stored in the PAGE command is not affected by PAGE_PLUS_READ. If PAGE_PLUS_READ is used to access data from a non-paged command, the Page Number byte is ignored.

This command uses the Process Call protocol. An example of the PAGE_PLUS_READ command with PEC is shown in Figure 52.

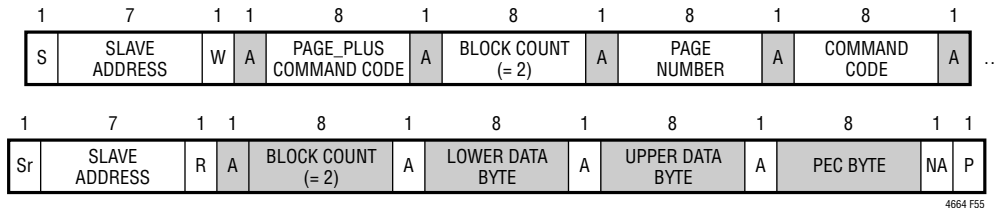

Figure 52. Example of PAGE_PLUS_READ

Note: PAGE_PLUS commands cannot be nested. A PAGE_PLUS command cannot be used to read or write another PAGE_PLUS command. If this is attempted, the LTM4664 will NACK the entire PAGE_PLUS packet and issue a CML fault for Invalid/Unsupported Data.

WRITE_PROTECT

The WRITE_PROTECT command is used to control writing to the LTM4664 device. This command does not indicate the status of the WP pin which is defined in the MFR_COMMON command. The WP pin takes precedence over the value of this command.

BYTE	MEANING
0x80	Disable all writes except to the WRITE_PROTECT, PAGE, MFR_EE_UNLOCK, and STORE_USER_ALL commands.
0x40	Disable all writes except to the WRITE_PROTECT, PAGE, MFR_EE_UNLOCK, MFR_CLEAR_PEAKEs, STORE_USER_ALL, OPERATION and CLEAR_FAULTS command. Individual fault bits can be cleared by writing a 1 to the respective bits in the STATUS commands.
0x20	Disable all writes except to the WRITE_PROTECT, OPERATION, MFR_EE_UNLOCK, MFR_CLEAR_PEAKEs, CLEAR_FAULTS, PAGE, ON_OFF_CONFIG, VOUT_COMMAND and STORE_USER_ALL. Individual fault bits can be cleared by writing a 1 to the respective bits in the STATUS commands.
0x10	Reserved, must be 0
0x08	Reserved, must be 0
0x04	Reserved, must be 0
0x02	Reserved, must be 0
0x01	Reserved, must be 0

Enable writes to all commands when WRITE_PROTECT is set to 0x00.

If WP pin is high, PAGE, OPERATION, MFR_CLEAR_PEAKEs, MFR_EE_UNLOCK, WRITE_PROTECT and CLEAR_FAULTS commands are supported. Individual fault bits can be cleared by writing a 1 to the respective bits in the STATUS commands.

PMBus COMMAND DETAILS

MFR_ADDRESS

The MFR_ADDRESS command byte sets the 7 bits of the PMBus slave address for this device.

Setting this command to a value of 0x80 disables device addressing. The GLOBAL device address, 0x5A and 0x5B, cannot be deactivated. If RCONFIG is set to ignore, the ASEL0 and ASEL1 pins are still used to determine the LSB and MSB, respectively, of the channel address. If the ASEL0 and ASEL1 pins are both open, the LTM4664 will use the address value stored in NVM. If the ASEL0 pin is open, the LTM4664 will use the lower 4 bits of the MFR_ADDRESS value stored in NVM to construct the effective address of the part. If the ASEL1 pin is open, the LTM4664 will use the upper 4 bits of the MFR_ADDRESS value stored in NVM to construct the effective address of the part.

This command has one data byte.

MFR_RAIL_ADDRESS

The MFR_RAIL_ADDRESS command enables direct device address access to the PAGE activated channel. The value of this command should be common to all devices attached to a single power supply rail.

The user should only perform command writes to this address. If a read is performed from this address and the rail devices do not respond with EXACTLY the same value, the LTM4664 will detect bus contention and may set a CML communications fault.

Setting this command to a value of 0x80 disables rail device addressing for the channel.

This command has one data byte.

GENERAL CONFIGURATION COMMANDS

COMMAND NAME	CMD CODE	DESCRIPTION	TYPE	PAGED	DATA FORMAT	UNITS	NVM	DEFAULT VALUE
MFR_CHAN_CONFIG	0xD0	Configuration bits that are channel specific.	R/W Byte	Y	Reg		Y	0x10
MFR_CONFIG_ALL	0xD1	General configuration bits.	R/W Byte	N	Reg		Y	0x21

MFR_CHAN_CONFIG

General purpose configuration command common to multiple ADI products.

BIT	MEANING
7	Reserved
6	Reserved
5	Reserved
4	Disable RUN Low. When asserted the RUN pin is not pulsed low if commanded OFF.
3	Enable Short Cycle recognition if this bit is set to a 1.
2	SHARE_CLOCK control. If SHARE_CLOCK is held low, the output is disabled.
1	No FAULT_ALERT, ALERT is not pulled low if FAULT is pulled low externally. Assert this bit if either POWER_GOOD or VOUT_UVUF are propagated on FAULT.
0	Disables the V _{OUT} decay value requirement for MFR_RETRY_TIME and t _{OFF(MIN)} processing. When this bit is set to a 0, the output must decay to less than 12.5% of the programmed value for any action that turns off the rail including a fault, an OFF/ON command, or a toggle of RUN from high to low to high.

This command has one data byte.

PMBus COMMAND DETAILS

A shortCycle event occurs whenever the PWM channel is commanded back ON, or reactivated, after the part has been commanded OFF and is processing either the TOFF_DELAY or the TOFF_FALL states. The PWM channel can be turned ON and OFF through either the RUN pin and or the PMBus OPERATION command.

If the PWM channel is reactivated during the TOFF_DELAY, the part will perform the following:

1. Immediately tri-state the PWM channel output;
2. Start the retry delay timer as specified by the $t_{OFF(MIN)}$.
3. After the $t_{OFF(MIN)}$ value has expired, the PWM channel will proceed to the TON_DELAY state and the STATUS_MFR_SPECIFIC bit #1 will assert.

If the PWM channel is reactivated during the TOFF_FALL, the part will perform the following:

1. Stop ramping down the PWM channel output;
2. Immediately tri-state the PWM channel output;
3. Start the retry delay timer as specified by the $t_{OFF(MIN)}$.
4. After the $t_{OFF(MIN)}$ value has expired, the PWM channel will proceed to the TON_DELAY state and the STATUS_MFR_SPECIFIC bit #1 will assert.

If the SHORT Cycle event occurs and the ShortCycle MFR_CHAN_CONFIG bit is not set, the PWM channel state machine will complete its TOFF_DELAY and TOFF_FALL operations as previously commanded by the user.

MFR_CONFIG_ALL

General purpose configuration command common to multiple ADI products.

BIT	MEANING
7	Enable Fault Logging
6	Ignore Resistor Configuration Pins
5	Mask PMBus, PartII, Section 10.9.1 Violations
4	Disable SYNC output
3	Enable 255ms PMBus timeout
2	A valid PEC required for PMBus writes to be accepted. If this bit is not set, the part will accept commands with invalid PEC.
1	Enable the use of PMBus clock stretching
0	Execute CLEAR_FAULTS on rising edge of either RUN pin.

This command has one data byte.

ON/OFF/MARGIN

COMMAND NAME	CMD CODE	DESCRIPTION	TYPE	PAGED	DATA FORMAT	UNITS	NVM	DEFAULT VALUE
ON_OFF_CONFIG	0x02	RUN pin and PMBus bus on/off command configuration.	R/W Byte	Y	Reg		Y	0x1E
OPERATION	0x01	Operating mode control. On/off, margin high and margin low.	R/W Byte	Y	Reg		Y	0x80
MFR_RESET	0xFD	Commanded reset without requiring a power-down.	Send Byte	N				NA

PMBus COMMAND DETAILS

ON_OFF_CONFIG

The ON_OFF_CONFIG command specifies the combination of RUN n pin input state and PMBus commands needed to turn the PWM channel on and off.

Supported Values:

VALUE	MEANING
0x1F	OPERATION value and RUN n pin must both command the device to start/run. Device executes immediate off when commanded off.
0x1E	OPERATION value and RUN n pin must both command the device to start/run. Device uses TOFF_ command values when commanded off.
0x17	RUN n pin control with immediate off when commanded off. OPERATION on/off control ignored.
0x16	RUN n pin control using TOFF_ command values when commanded off. OPERATION on/off control ignored.

Programming an unsupported ON_OFF_CONFIG value will generate a CML fault and the command will be ignored.

This command has one data byte.

OPERATION

The OPERATION command is used to turn the unit on and off in conjunction with the input from the RUN n pins. It is also used to cause the unit to set the output voltage to the upper or lower MARGIN VOLTAGEs. The unit stays in the commanded operating mode until a subsequent OPERATION command or change in the state of the RUN n pin instructs the device to change to another mode. If the part is stored in the MARGIN_LOW/HIGH state, the next RESET or POWER_ON cycle will ramp to that state. If the OPERATION command is modified, for example ON is changed to MARGIN_LOW, the output will move at a fixed slope set by the VOUT_TRANSITION_RATE. The default operation command is sequence off. If V_{IN} is applied to a part with factory default programming and the VOUT_CONFIG resistor configuration pins are not installed, the outputs will be commanded off.

The part defaults to the Sequence Off state.

This command has one data byte.

Supported Values:

VALUE	MEANING
0xA8	Margin high.
0x98	Margin low.
0x80	On (V_{OUT} back to nominal even if bit 3 of ON_OFF_CONFIG is not set).
0x40*	Soft off (with sequencing).
0x00*	Immediate off (no sequencing).

*Device does not respond to these commands if bit 3 of ON_OFF_CONFIG is not set.

Programming an unsupported OPERATION value will generate a CML fault and the command will be ignored.

This command has one data byte.

MFR_RESET

This command provides a means to reset the LTM4664 PSM from the serial bus. This forces the LTM4664 PSM to turn off both PWM channels, load the operating memory from internal EEPROM, clear all faults and then perform a soft-start of both PWM channels, if enabled.

This write-only command has no data bytes.

PMBus COMMAND DETAILS

PWM CONFIGURATION

COMMAND NAME	CMD CODE	DESCRIPTION	TYPE	PAGED	DATA FORMAT	UNITS	NVM	DEFAULT VALUE
MFR_PWM_COMP	0xD3	PWM loop compensation configuration	R/W Byte	Y	Reg		Y	0x28
MFR_PWM_MODE	0xD4	Configuration for the PWM engine.	R/W Byte	Y	Reg		Y	0xC7
MFR_PWM_CONFIG	0xF5	Set numerous parameters for the DC/DC controller including phasing.	R/W Byte	N	Reg		Y	0x10
FREQUENCY_SWITCH	0x33	Switching frequency of the controller.	R/W Word	N	L11	kHz	Y	350kHz 0xFABC

MFR_PWM_MODE

The MFR_PWM_MODE command sets important PWM controls for each channel.

The MFR_PWM_MODE command allows the user to program the PWM controller to use discontinuous (pulse-skipping mode), or forced continuous conduction mode.

BIT	MEANING
7	Use High Range of I _{LIMIT}
0b	Low Current Range
1b	High Current Range
6	Enable Servo Mode
5	External temperature sense: 0: ΔV _{BE} measurement. Now reserved, ΔV _{BE} only supported.
[4:3]	Reserved
2	Reserved, always low DCR current sense
1	V _{OUT} Range
1b	The maximum output voltage is 2.75V
0b	The maximum output voltage is 3.6V
Bit[0]	Mode
0b	Discontinuous
1b	Forced Continuous

Bit [7] of this command determines if the part is in high range or low range of the IOUT_OC_FAULT_LIMIT command. Changing this bit value changes the PWM loop gain and compensation. This bit value should not be changed when the channel output is active. Writing this bit when the channel is active will generate a CML fault.

Bit [6] The LTM4664 PSM will not servo while the part is OFF, ramping on or ramping off. When set to a one, the output servo is enabled. The output set point DAC will be slowly adjusted to minimize the difference between the READ_VOUT_ADC and the VOUT_COMMAND (or the appropriate margined value).

The LTM4664 PSM computes temperature in °C from ΔV_{BE} measured by the ADC at the TSNS_n pin as

$$T = (G \cdot \Delta V_{BE} \cdot q / (K \cdot \ln(16))) - 273.15 + 0$$

PMBus COMMAND DETAILS

For both equations,

$$G = \text{MFR_TEMP_1_GAIN} \cdot 2^{-14}, \text{ and}$$

$$O = \text{MFR_TEMP_1_OFFSET}$$

Bit[2] is now reserved, and Ultra Low DCR mode is default.

Bit[1] of this command determines if the part is in high range or low voltage range. Changing this bit value changes the PWM loop gain and compensation. This bit value should not be changed when the channel output is active. Writing this bit when the channel is active will generate a CML fault.

Bit[0] determines if the PWM mode of operation is discontinuous (pulse-skipping mode), or forced continuous conduction mode. Whenever the channel is ramping on, the PWM mode will be discontinuous, regardless of the value of this bit. This command has one data byte.

MFR_PWM_COMP

The MFR_PWM_COMP command sets the g_m of the PWM channel error amplifiers and the value of the internal R_{ITHn} compensation resistors. This command affects the loop gain of the PWM output which may require modifications to the external compensation network.

BIT	MEANING
BIT [7:5]	Error Amplifier GM Adjust (ms)
000b	1.00
001b	1.68
010b	2.35
011b	3.02
100b	3.69
101b	4.36
110b	5.04
111b	5.73
BIT [4:0]	R_{COMP} (kΩ)
00000b	0
00001b	0.25
00010b	0.5
00011b	0.75
00100b	1
00101b	1.25
00110b	1.5
00111b	1.75
01000b	2
01001b	2.5
01010b	3
01011b	3.5
01100b	4
01101b	4.5
01110b	5

PMBus COMMAND DETAILS

01111b	5.5
10000b	6
10001b	7
10010b	8
10011b	9
10100b	11
10101b	13
10110b	15
10111b	17
11000b	20
11001b	24
11010b	28
11011b	32
11100b	38
11101b	46
11110b	54
11111b	62

This command has one data byte.

MFR_PWM_CONFIG

The MFR_PWM_CONFIG command sets the switching frequency phase offset with respect to the falling edge of the SYNC signal. The part must be in the OFF state to process this command. Either the RUN pins must be low or the channels must be commanded off. If either channel is in the RUN state and this command is written, the command will be NACK'd and a BUSY fault will be asserted.

BIT	MEANING	
7	Reserved	
[6:5]	Input current sense gain.	
00b	2x gain. 0mV to 50mV range.	
01b	4x gain. 0mV to 20mV range.	
10b	8x gain. 0mV to 5mV range.	
11b	Reserved	
4	Share Clock Enable : If this bit is 1, the SHARE_CLK pin will not be released until $V_{IN} > V_{IN_ON}$. The SHARE_CLK pin will be pulled low when $V_{IN} < V_{IN_OFF}$. If this bit is 0, the SHARE_CLK pin will not be pulled low when $V_{IN} < V_{IN_OFF}$ except for the initial application of V_{IN} .	
BIT [2:0]	CHANNEL 0 (DEGREES)	CHANNEL 1 (DEGREES)
000b	0	180
001b	90	270
010b	0	240
011b	0	120
100b	120	240
101b	60	240
110b	120	300

PMBus COMMAND DETAILS

FREQUENCY_SWITCH

The FREQUENCY_SWITCH command sets the switching frequency, in kHz, of the LTM4664.

Supported Frequencies:

VALUE [15:0]	RESULTING FREQUENCY (TYP)
0x0000	External Oscillator
0xF3E8	250kHz
0xFABC	350kHz
0xFB52	425kHz
0FBE8	500kHz
0x023F	575kHz
0x028A	650kHz
0x02EE	750kHz
0x03E8	1000kHz

The part must be in the OFF state to process this command. The RUN pin must be low or both channels must be commanded off. If the part is in the RUN state and this command is written, the command will be NACK'd and a BUSY fault will be asserted. When the part is commanded off and the frequency is changed, a PLL_UNLOCK status may be detected as the PLL locks onto the new frequency.

This command has two data bytes and is formatted in Linear_5s_11s format.

VOLTAGE

Input Voltage and Limits

COMMAND NAME	CMD CODE	DESCRIPTION	TYPE	PAGED	DATA FORMAT	UNITS	NVM	DEFAULT VALUE
VIN_OV_FAULT_LIMIT	0x55	Input supply overvoltage fault limit.	R/W Word	N	L11	V	Y	15.5 0xD3E0
VIN_UV_WARN_LIMIT	0x58	Input supply undervoltage warning limit.	R/W Word	N	L11	V	Y	4.65 0xCA53
VIN_ON	0x35	Input voltage at which the unit should start power conversion.	R/W Word	N	L11	V	Y	4.75 0xCA60
VIN_OFF	0x36	Input voltage at which the unit should stop power conversion.	R/W Word	N	L11	V	Y	4.5 0xCA40
MFR_RVIN		The resistance value of the V _{IN} pin filter element in milliohms Set at Factory				mΩ	Y	1000 0x03E8

VIN_OV_FAULT_LIMIT

The VIN_OV_FAULT_LIMIT command sets the value of the input voltage measured by the ADC, in volts, that causes an input overvoltage fault.

This command has two data bytes in Linear_5s_11s format.

PMBus COMMAND DETAILS

VIN_UV_WARN_LIMIT

The VIN_UV_WARN_LIMIT command sets the value of input voltage measured by the ADC that causes an input under-voltage warning. This warning is disabled until the input exceeds the input startup threshold value set by the VIN_ON command and the unit has been enabled. If the V_{IN} Voltage drops below the VIN_OV_WARN_LIMIT the device:

- Sets the INPUT Bit Is the STATUS_WORD
- Sets the V_{IN} Undervoltage Warning Bit in the STATUS_INPUT Command
- Notifies the Host by Asserting \overline{ALERT} , unless Masked

VIN_ON

The VIN_ON command sets the input voltage, in Volts, at which the unit starts power conversion.

This command has two data bytes and is formatted in Linear_5s_11s format.

VIN_OFF

The VIN_OFF command sets the input voltage, in Volts, at which the unit stops power conversion.

This command has two data bytes and is formatted in Linear_5s_11s format.

MFR_RVIN

The MFR_RVIN command is not available, MFR_RVIN is set at factory assembly with 1 Ω .

This command has two data bytes and is formatted in Linear_5s_11s format.

Output Voltage and Limits

COMMAND NAME	CMD CODE	DESCRIPTION	TYPE	PAGED	DATA FORMAT	UNITS	NVM	DEFAULT VALUE
VOUT_MODE	0x20	Output voltage format and exponent (2^{-12}).	R Byte	Y	Reg			2^{-12} 0x14
VOUT_MAX	0x24	Upper limit on the output voltage the unit can command regardless of any other commands.	R/W Word	Y	L16	V	Y	1.8 0x2CCD
VOUT_OV_FAULT_LIMIT	0x40	Output overvoltage fault limit.	R/W Word	Y	L16	V	Y	1.1 0x119A
VOUT_OV_WARN_LIMIT	0x42	Output overvoltage warning limit.	R/W Word	Y	L16	V	Y	1.075 0x1133
VOUT_MARGIN_HIGH	0x25	Margin high output voltage set point. Must be greater than VOUT_COMMAND.	R/W Word	Y	L16	V	Y	1.05 0x10CD
VOUT_COMMAND	0x21	Nominal output voltage set point.	R/W Word	Y	L16	V	Y	1.0 0x1000
VOUT_MARGIN_LOW	0x26	Margin low output voltage set point. Must be less than VOUT_COMMAND.	R/W Word	Y	L16	V	Y	0.95 0x0F33
VOUT_UV_WARN_LIMIT	0x43	Output undervoltage warning limit.	R/W Word	Y	L16	V	Y	0.925 0x0ECD
VOUT_UV_FAULT_LIMIT	0x44	Output undervoltage fault limit.	R/W Word	Y	L16	V	Y	0.9 0x0E66
MFR_VOUT_MAX	0xA5	Maximum allowed output voltage.	R Word	Y	L16	V		7.8 0x1CCD

PMBus COMMAND DETAILS

VOUT_MODE

The data byte for VOUT_MODE command, used for commanding and reading output voltage, consists of a 3-bit mode (only linear format is supported) and a 5-bit parameter representing the exponent used in output voltage Read/Write commands.

This read-only command has one data byte.

VOUT_MAX

The VOUT_MAX command sets an upper limit on any voltage, including VOUT_MARGIN_HIGH, the unit can command regardless of any other commands or combinations. The maximum allowed value of this command is 3.6V. The maximum output voltage the LTM4664 PSM can produce is 1.8V including VOUT_MARGIN_HIGH. However, the VOUT_OV_FAULT_LIMIT can be commanded as high as 3.6V.

This command has two data bytes and is formatted in Linear_16u format.

VOUT_OV_FAULT_LIMIT

The VOUT_OV_FAULT_LIMIT command sets the value of the output voltage measured by the OV supervisor comparator at the sense pins, in volts, which causes an output overvoltage fault.

If the VOUT_OV_FAULT_LIMIT is modified and the part is in the RUN state, allow 10ms after the command is modified to assure the new value is being honored. The part indicates if it is busy making a calculation. Monitor bits 5 and 6 of MFR_COMMON. Either bit is low if the part is busy. If this wait time is not honored and the VOUT_COMMAND is modified above the old overvoltage limit, an OV condition might temporarily be detected resulting in undesirable behavior and possible damage to the switcher.

If VOUT_OV_FAULT_RESPONSE is set to OV_PULLDOWN or 0x00, the $\overline{\text{FAULT}}$ pin will not assert if VOUT_OV_FAULT is propagated. The LTM4664 PSM will pull the TG low and assert the BG bit as soon as the overvoltage condition is detected.

This command has two data bytes and is formatted in Linear_16u format.

VOUT_OV_WARN_LIMIT

The VOUT_OV_WARN_LIMIT command sets the value of the output voltage measured by the ADC at the sense pins, in volts, which causes an output voltage high warning. The MFR_VOUT_PEAK value can be used to determine if this limit has been exceeded.

In response to the VOUT_OV_WARN_LIMIT being exceeded, the device:

- Sets the NONE_OF_THE_ABOVE bit in the STATUS_BYTE
- Sets the VOUT bit in the STATUS_WORD
- Sets the VOUT Overvoltage Warning bit in the STATUS_VOUT command
- Notifies the host by asserting $\overline{\text{ALERT}}$ pin, unless masked

This condition is detected by the ADC so the response time may be up to t_{CONVERT} .

This command has two data bytes and is formatted in Linear_16u format.

PMBus COMMAND DETAILS

VOUT_MARGIN_HIGH

The VOUT_MARGIN_HIGH command loads the unit with the voltage to which the output is to be changed, in Volts, when the OPERATION command is set to “Margin High”. The value should be greater than VOUT_COMMAND. The maximum guaranteed value on VOUT_MARGIN_HIGH is 3.6V.

This command will not be acted on during TON_RISE and TOFF_FALL output sequencing. The VOUT_TRANSITION_RATE will be used if this command is modified while the output is active and in a steady-state condition.

This command has two data bytes and is formatted in Linear_16u format.

VOUT_COMMAND

The VOUT_COMMAND consists of two bytes and is used to set the output voltage, in volts. The maximum guaranteed value on VOUT is 3.6V.

This command will not be acted on during TON_RISE and TOFF_FALL output sequencing. The VOUT_TRANSITION_RATE will be used if this command is modified while the output is active and in a steady-state condition.

This command has two data bytes and is formatted in Linear_16u format.

VOUT_MARGIN_LOW

The VOUT_MARGIN_LOW command loads the unit with the voltage to which the output is to be changed, in volts, when the OPERATION command is set to “Margin Low”. The value must be less than VOUT_COMMAND.

This command will not be acted on during TON_RISE and TOFF_FALL output sequencing. The VOUT_TRANSITION_RATE will be used if this command is modified while the output is active and in a steady-state condition.

This command has two data bytes and is formatted in Linear_16u format.

VOUT_UV_WARN_LIMIT

The VOUT_UV_WARN_LIMIT command reads the value of the output voltage measured by the ADC at the sense pins, in volts, which causes an output voltage low warning.

In response to the VOUT_UV_WARN_LIMIT being exceeded, the device:

- Sets the NONE_OF_THE_ABOVE bit in the STATUS_BYTE
- Sets the VOUT bit in the STATUS_WORD
- Sets the VOUT Undervoltage Warning bit in the STATUS_VOUT command
- Notifies the host by asserting $\overline{\text{ALERT}}$ pin, unless masked

This command has two data bytes and is formatted in Linear_16u format.

VOUT_UV_FAULT_LIMIT

The VOUT_UV_FAULT_LIMIT command reads the value of the output voltage measured by the UV supervisor comparator at the sense pins, in volts, which causes an output undervoltage fault.

This command has two data bytes and is formatted in Linear_16u format.

PMBus COMMAND DETAILS

MFR_VOUT_MAX

The MFR_VOUT_MAX command is the maximum output voltage in volts for each channel, including VOUT_OV_FAULT_LIMIT. If the output voltages are set to high range (Bit 6 of MFR_PWM_CONFIG set to a 0) MFR_VOUT_MAX is 3.6V. If the output voltage is set to low range (Bit 6 of MFR_PWM_CONFIG set to a 1) the MFR_VOUT_MAX is 2.75V. Entering a VOUT_COMMAND value greater than this will result in a CML fault and the output voltage setting will be clamped to the maximum level. This will also result in Bit 3 VOUT_MAX_Warning in the STATUS_VOUT command being set. The maximum value to program is 1.8V and maximum operating is 1.5V.

This read only command has 2 data bytes and is formatted in Linear_16u format.

OUTPUT CURRENT AND LIMITS

COMMAND NAME	CMD CODE	DESCRIPTION	TYPE	PAGED	DATA FORMAT	UNITS	NVM	DEFAULT VALUE
MFR_IOUT_CAL_GAIN	0xDA	The ratio of the voltage at the current sense pins to the sensed current. For devices using a fixed current sense resistor, it is the resistance value in mΩ.	R Word	Y	L11	mΩ	Y	0.375 0xD018
MFR_IOUT_CAL_GAIN_TC	0xF6	Temperature coefficient of the current sensing element.	R/W Word	Y	CF		Y	3900 0x0F3C
IOUT_OC_FAULT_LIMIT	0x46	Output overcurrent fault limit.	R/W Word	Y	L11	A	Y	45.0 0xE2D0
IOUT_OC_WARN_LIMIT	0x4A	Output overcurrent warning limit.	R/W Word	Y	L11	A	Y	34.0 0xE230

MFR_IOUT_CAL_GAIN

The MFR_IOUT_CAL_GAIN command is used to set the resistance value of the current sense resistor in milliohms. (see also MFR_IOUT_CAL_GAIN_TC).

This command has two data bytes and is formatted in Linear_5s_11s format.

MFR_IOUT_CAL_GAIN_TC

The MFR_IOUT_CAL_GAIN_TC command allows the user to program the temperature coefficient of the IOUT_CAL_GAIN sense resistor or inductor DCR in ppm/°C.

This command has two data bytes and is formatted in 16-bit 2's complement integer ppm. $N = -32768$ to $32767 \cdot 10^{-6}$. Nominal temperature is 27°C. The MFR_IOUT_CAL_GAIN is multiplied by:

$$[1.0 + \text{MFR_IOUT_CAL_GAIN_TC} \cdot (\text{READ_TEMPERATURE_1} - 27)].$$

DCR sensing will have a typical value of 3900.

The MFR_IOUT_CAL_GAIN and MFR_IOUT_CAL_GAIN_TC impact all current parameters including: READ_IOUT, MFR_IOUT_PEAK, IOUT_OC_FAULT_LIMIT and IOUT_OC_WARN_LIMIT.

PMBus COMMAND DETAILS

IOUT_OC_FAULT_LIMIT

The IOUT_OC_FAULT_LIMIT command sets the value of the peak output current limit, in Amperes. When the controller is in current limit, the overcurrent detector will indicate an overcurrent fault condition. The following table lists the programmable peak output current limit value in mV between I_{SENSE}^+ and I_{SENSE}^- . The actual value of current limit is $(I_{SENSE}^+ - I_{SENSE}^-)/MFR_IOUT_CAL_GAIN$ in Amperes.

MFR_PWM_MODE[7] = 1b, High Current Range (mV)	ILPEAK (A)	IOUT (A)	MFR_PWM_MODE[7] = 0b, Use ILIM Low Range Low Current Range (mV)	ILPEAK (A)	IOUT (A)
18.86	Not Needed	Not Needed	10.48	29.9	23.9
20.42	Not Needed	Not Needed	11.34	32.4	26.4
21.14	Not Needed	Not Needed	*11.74	33.54	27.54
22.27	Not Needed	Not Needed	12.37	35.3	29.3
23.41	Not Needed	Not Needed	13.01	37.1	31.1
24.55	Not Needed	Not Needed	13.64	38.9	32.9
25.68	Not Needed	Not Needed	14.27	40.8	34.8
26.82	Not Needed	Not Needed	14.90	42.6	36.6

* = Recommended for 25A Current Limit Plus Some Headroom

Note: This is the peak of the current waveform. The READ_IOUT command returns the average current. The peak output current limits are adjusted with temperature based on the MFR_IOUT_CAL_GAIN_TC using the equation:

$$\text{Peak Current Limit} = \text{MFR_IOUT_CAL_GAIN} \cdot (1 + \text{MFR_IOUT_CAL_GAIN_TC} \cdot (\text{READ_TEMPERTURE}_1 - 27.0)).$$

The LTM4664 automatically converts currents to the appropriate internal bit value.

The IOUT range is set with bit 7 of the MFR_PWM_MODE command.

The IOUT_OC_FAULT_LIMIT is ignored during TON_RISE and TOFF_FALL.

If the IOUT_OC_FAULT_LIMIT is exceeded, the device:

- Sets the IOUT bit in the STATUS word
- Sets the IOUT Overcurrent fault bit in the STATUS_IOUT
- Notifies the host by asserting $\overline{\text{ALERT}}$, unless masked

This command has two data bytes and is formatted in Linear_5s_11s format.

**MFR_PWM_MODE[7]=1 is the high current range for ultra low DCR sensing. This range should be used since these current threshold values are too large for the LTM4664.

*Recommended for 35% up bove 25A current limit

PMBus COMMAND DETAILS

IOUT_OC_WARN_LIMIT

This command sets the value of the output current measured by the ADC that causes an output overcurrent warning in Amperes. The READ_IOUT value will be used to determine if this limit has been exceeded.

In response to the IOUT_OC_WARN_LIMIT being exceeded, the device:

- Sets the NONE_OF_THE_ABOVE bit in the STATUS_BYTE
- Sets the IOUT bit in the STATUS_WORD
- Sets the IOUT Overcurrent Warning bit in the STATUS_IOUT command, and
- Notifies the host by asserting $\overline{\text{ALERT}}$ pin, unless masked

The IOUT_OC_FAULT_LIMIT is ignored during TON_RISE and TOFF_FALL.

This command has two data bytes and is formatted in Linear_5s_11s format

Input Current and Limits

COMMAND NAME	CMD CODE	DESCRIPTION	TYPE	DATA FORMAT	UNITS	NVM	DEFAULT VALUE
MFR_IIN_CAL_GAIN	0xE8	The resistance value of the input current sense element in m Ω .	R/W Word	L11	m Ω	Y	2 0xC200

MFR_IIN_CAL_GAIN

The MFR_IIN_CAL_GAIN command is used to set the resistance value of the input current sense resistor in milliohms. (see also READ_IIN).

This command has two data bytes and is formatted in Linear_5s_11s format.

COMMAND NAME	CMD CODE	DESCRIPTION	TYPE	PAGED	DATA FORMAT	UNITS	NVM	DEFAULT VALUE
IIN_OC_WARN_LIMIT	0x5D	Input overcurrent warning limit.	R/W Word	N	L11	A	Y	10.0 0xD280

IIN_OC_WARN_LIMIT

The IIN_OC_WARN_LIMIT command sets the value of the input current measured by the ADC, in amperes, that causes a warning indicating the input current is high. The READ_IIN value will be used to determine if this limit has been exceeded.

In response to the IIN_OC_WARN_LIMIT being exceeded, the device:

- Sets the OTHER bit in the STATUS_BYTE
- Sets the INPUT bit in the upper byte of the STATUS_WORD
- Sets the IIN Overcurrent Warning bit[1] in the STATUS_INPUT command, and
- Notifies the host by asserting $\overline{\text{ALERT}}$ pin

This command has two data bytes and is formatted in Linear_5s_11s format.

PMBus COMMAND DETAILS

TEMPERATURE

External Temperature Calibration

COMMAND NAME	CMD CODE	DESCRIPTION	TYPE	PAGED	DATA FORMAT	UNITS	NVM	DEFAULT VALUE
MFR_TEMP_1_GAIN	0xF8	Sets the slope of the external temperature sensor.	R/W Word	Y	CF		Y	0.995 0x3FAE
MFR_TEMP_1_OFFSET	0xF9	Sets the offset of the external temperature sensor.	R/W Word	Y	L11	C	Y	0.0 0x8000

MFR_TEMP_1_GAIN

The MFR_TEMP_1_GAIN command will modify the slope of the external temperature sensor to account for non-idealities in the element and errors associated with the remote sensing of the temperature in the inductor.

This command has two data bytes and is formatted in 16-bit 2's complement integer. The effective gain adjustment is $N \cdot 2^{-14}$. The nominal value is 1.

MFR_TEMP_1_OFFSET

The MFR_TEMP_1_OFFSET command will modify the offset of the external temperature sensor to account for non-idealities in the element and errors associated with the remote sensing of the temperature in the inductor.

This command has two data bytes and is formatted in Linear_5s_11s format.

External Temperature Limits

COMMAND NAME	CMD CODE	DESCRIPTION	TYPE	PAGED	DATA FORMAT	UNITS	NVM	DEFAULT VALUE
OT_FAULT_LIMIT	0x4F	Power stage overtemperature fault limit.	R/W Word	Y	L11	C	Y	128 0xF200
OT_WARN_LIMIT	0x51	Power stage overtemperature warning limit.	R/W Word	Y	L11	C	Y	125 0xEBE8
UT_FAULT_LIMIT	0x53	Power stage undertemperature fault limit.	R/W Word	Y	L11	C	Y	-45 0xE530

OT_FAULT_LIMIT

The OT_FAULT_LIMIT command sets the value of the external sense temperature measured by the ADC, in degrees Celsius, which causes an overtemperature fault. The READ_TEMPERATURE_1 value will be used to determine if this limit has been exceeded.

This command has two data bytes and is formatted in Linear_5s_11s format.

OT_WARN_LIMIT

The OT_WARN_LIMIT command sets the value of the external sense temperature measured by the ADC, in degrees Celsius, which causes an overtemperature warning. The READ_TEMPERATURE_1 value will be used to determine if this limit has been exceeded.

PMBus COMMAND DETAILS

In response to the OT_WARN_LIMIT being exceeded, the device:

- Sets the TEMPERATURE bit in the STATUS_BYTE
- Sets the Overtemperature Warning bit in the STATUS_TEMPERATURE command, and
- Notifies the host by asserting $\overline{\text{ALERT}}$ pin, unless masked

This command has two data bytes and is formatted in Linear_5s_11s format.

UT_FAULT_LIMIT

The UT_FAULT_LIMIT command sets the value of the power stage sense temperature measured by the ADC, in degrees Celsius, which causes an undertemperature fault. The READ_TEMPERATURE_1 value will be used to determine if this limit has been exceeded.

Note: If the temp sensors are not installed, the UT_FAULT_LIMIT can be set to -275°C and UT_FAULT_LIMIT response set to ignore to avoid $\overline{\text{ALERT}}$ being asserted.

This command has two data bytes and is formatted in Linear_5s_11s format.

TIMING

Timing—On Sequence/Ramp

COMMAND NAME	CMD CODE	DESCRIPTION	TYPE	PAGED	DATA FORMAT	UNITS	NVM	DEFAULT VALUE
TON_DELAY	0x60	Time from RUN and/or Operation on to output rail turn-on.	R/W Word	Y	L11	ms	Y	0.0 0x8000
TON_RISE	0x61	Time from when the output starts to rise until the output voltage reaches the VOUT commanded value.	R/W Word	Y	L11	ms	Y	3 0xC300
TON_MAX_FAULT_LIMIT	0x62	Maximum time from the start of TON_RISE for VOUT to cross the VOUT_UV_FAULT_LIMIT.	R/W Word	Y	L11	ms	Y	5 0xCA80
VOUT_TRANSITION_RATE	0x27	Rate the output changes when VOUT commanded to a new value.	R/W Word	Y	L11	V/ms	Y	0.001 0x8042

TON_DELAY

The TON_DELAY command sets the time, in milliseconds, from when a start condition is received until the output voltage starts to rise. Values from 0ms to 83 seconds are valid. The resulting turn-on delay will have a typical delay of 270 μs for TON_DELAY = 0 and an uncertainty of $\pm 50\mu\text{s}$ for all values of TON_DELAY.

This command has two data bytes and is formatted in Linear_5s_11s format.

TON_RISE

The TON_RISE command sets the time, in milliseconds, from the time the output starts to rise to the time the output enters the regulation band. Values from 0 to 1.3 seconds are valid. The part will be in discontinuous mode during TON_RISE events. If TON_RISE is less than 0.25ms, the LTM4664 digital slope will be bypassed and the output voltage transition will only be controlled by the analog performance of the PWM switcher. The number of steps in TON_RISE is equal to TON_RISE (in ms)/0.1ms with an uncertainty of $\pm 0.1\text{ms}$.

This command has two data bytes and is formatted in Linear_5s_11s format.

PMBus COMMAND DETAILS

TON_MAX_FAULT_LIMIT

The TON_MAX_FAULT_LIMIT command sets the value, in milliseconds, on how long the unit can attempt to power up the output without reaching the output undervoltage fault limit.

A data value of 0ms means that there is no limit and that the unit can attempt to bring up the output voltage indefinitely. The maximum limit is 83 seconds.

This command has two data bytes and is formatted in Linear_5s_11s format.

VOUT_TRANSITION_RATE

When a PMBus device receives either a VOUT_COMMAND or OPERATION (Margin High, Margin Low) that causes the output voltage to change this command set the rate in V/ms at which the output voltage changes. The commanded rate of change does not apply when the unit is commanded on or off. The maximum allowed slope is 4V/ms.

This command has two data bytes and is formatted in Linear_5s_11s format.

Timing—Off Sequence/Ramp

COMMAND NAME	CMD CODE	DESCRIPTION	TYPE	PAGED	DATA FORMAT	UNITS	NVM	DEFAULT VALUE
TOFF_DELAY	0x64	Time from RUN and/or Operation off to the start of TOFF_FALL ramp.	R/W Word	Y	L11	ms	Y	0.0 0x8000
TOFF_FALL	0x65	Time from when the output starts to fall until the output reaches zero volts.	R/W Word	Y	L11	ms	Y	3 0xC300
TOFF_MAX_WARN_LIMIT	0x66	Maximum allowed time, after TOFF_FALL completed, for the unit to decay below 12.5%.	R/W Word	Y	L11	ms	Y	0 0x8000

TOFF_DELAY

The TOFF_DELAY command sets the time, in milliseconds, from when a stop condition is received until the output voltage starts to fall. Values from 0 to 83 seconds are valid. The resulting turn off delay will have a typical delay of 270µs for TOFF_DELAY = 0 and an uncertainty of ±50µs for all values of TOFF_DELAY. TOFF_DELAY is not applied when a fault event occurs

This command has two data bytes and is formatted in Linear_5s_11s format.

TOFF_FALL

The TOFF_FALL command sets the time, in milliseconds, from the end of the turn-off delay time until the output voltage is commanded to zero. It is the ramp time of the V_{OUT} DAC. When the V_{OUT} DAC is zero, the PWM output will be set to high impedance state.

The part will maintain the mode of operation programmed. For defined TOFF_FALL times, the user should set the part to continuous conduction mode. Loading the max value indicates the part will ramp down at the slowest possible rate. The minimum supported fall time is 0.25ms. A value less than 0.25ms will result in a 0.25ms ramp. The maximum fall time is 1.3 seconds. The number of steps in TOFF_FALL is equal to TOFF_FALL (in ms)/0.1ms with an uncertainty of ±0.1ms.

In discontinuous conduction mode, the controller will not draw current from the load and the fall time will be set by the output capacitance and load current.

This command has two data bytes and is formatted in Linear_5s_11s format.

PMBus COMMAND DETAILS

TOFF_MAX_WARN_LIMIT

The TOFF_MAX_WARN_LIMIT command sets the value, in milliseconds, on how long the output voltage exceeds 12.5% of the programmed voltage before a warning is asserted. The output is considered off when the V_{OUT} voltage is less than 12.5% of the programmed VOUT_COMMAND value. The calculation begins after TOFF_FALL is complete.

A data value of 0ms means that there is no limit and that the output voltage exceeds 12.5% of the programmed voltage indefinitely. Other than 0, values from 120ms to 524 seconds are valid.

This command has two data bytes and is formatted in Linear_5s_11s format.

Precondition for Restart

COMMAND NAME	CMD CODE	DESCRIPTION	TYPE	PAGED	DATA FORMAT	UNITS	NVM	DEFAULT VALUE
MFR_RESTART_DELAY	0xDC	Minimum time the RUN pin is held low by the LTM4664.	R/W Word	Y	L11	ms	Y	150 0xF258

MFR_RESTART_DELAY

This command specifies the minimum RUN off time in milliseconds. This device will pull the RUN pin low for this length of time once a falling edge of RUN has been detected. The minimum recommended value is 136ms.

Note: The restart delay is different than the retry delay. The restart delay pulls RUN low for the specified time, after which a standard start-up sequence is initiated. The minimum restart delay should be equal to TOFF_DELAY + TOFF_FALL + 136ms. Valid values are from 136ms to 65.52 seconds in 16ms increments. To assure a minimum off time, set the MFR_RESTART_DELAY 16ms longer than the desired time. The output rail can be off longer than the MFR_RESTART_DELAY after the RUN pin is pulled high if the output decay bit 0 is enabled in MFR_CHAN_CONFIG and the output takes a long time to decay below 12.5% of the programmed value.

This command has two data bytes and is formatted in Linear_5s_11s format.

FAULT RESPONSE

Fault Responses All Faults

COMMAND NAME	CMD CODE	DESCRIPTION	TYPE	PAGED	DATA FORMAT	UNITS	NVM	DEFAULT VALUE
MFR_RETRY_DELAY	0xDB	Retry interval during FAULT retry mode.	R/W Word	Y	L11	ms	Y	250 0xF3E8

MFR_RETRY_DELAY

This command sets the time in milliseconds between retries if the fault response is to retry the controller at specified intervals. This command value is used for all fault responses that require retry. The retry time starts once the fault has been detected by the offending channel. Valid values are from 120ms to 83.88 seconds in 10 μ s increments.

Note: The retry delay time is determined by the longer of the MFR_RETRY_DELAY command or the time required for the regulated output to decay below 12.5% of the programmed value. If the natural decay time of the output is too long, it is possible to remove the voltage requirement of the MFR_RETRY_DELAY command by asserting bit 0 of MFR_CHAN_CONFIG.

This command has two data bytes and is formatted in Linear_5s_11s format.

PMBus COMMAND DETAILS

Fault Responses Input Voltage

COMMAND NAME	CMD CODE	DESCRIPTION	TYPE	PAGED	DATA FORMAT	UNITS	NVM	DEFAULT VALUE
VIN_OV_FAULT_RESPONSE	0x56	Action to be taken by the device when an input supply overvoltage fault is detected.	R/W Byte	Y	Reg		Y	0x80

VIN_OV_FAULT_RESPONSE

The VIN_OV_FAULT_RESPONSE command instructs the device on what action to take in response to an input overvoltage fault. The data byte is in the format given in Table 17.

The device also:

- Sets the NONE_OF_THE_ABOVE bit in the STATUS_BYTE
- Set the INPUT bit in the upper byte of the STATUS_WORD
- Sets the VIN Overvoltage Fault bit in the STATUS_INPUT command, and
- Notifies the host by asserting $\overline{\text{ALERT}}$ pin, unless masked

This command has one data byte.

Fault Responses Output Voltage

COMMAND NAME	CMD CODE	DESCRIPTION	TYPE	PAGED	DATA FORMAT	UNITS	NVM	DEFAULT VALUE
VOUT_OV_FAULT_RESPONSE	0x41	Action to be taken by the device when an output overvoltage fault is detected.	R/W Byte	Y	Reg		Y	0xB8
VOUT_UV_FAULT_RESPONSE	0x45	Action to be taken by the device when an output undervoltage fault is detected.	R/W Byte	Y	Reg		Y	0xB8
TON_MAX_FAULT_RESPONSE	0x63	Action to be taken by the device when a TON_MAX_FAULT event is detected.	R/W Byte	Y	Reg		Y	0xB8

VOUT_OV_FAULT_RESPONSE

The VOUT_OV_FAULT_RESPONSE command instructs the device on what action to take in response to an output overvoltage fault. The data byte is in the format given in Table 13.

The device also:

- Sets the VOUT_OV bit in the STATUS_BYTE
- Sets the VOUT bit in the STATUS_WORD
- Sets the VOUT Overvoltage Fault bit in the STATUS_VOUT command
- Notifies the host by asserting $\overline{\text{ALERT}}$ pin, unless masked

The only values recognized for this command are:

0x00—Part performs OV pull down only, or OV_PULLDOWN.

0x80—The device shuts down (disables the output) and the unit does not attempt to retry. (PMBus, Part II, Section 10.7).

PMBus COMMAND DETAILS

0xB8—The device shuts down (disables the output) and device attempts to retry continuously, without limitation, until it is commanded OFF (by the RUN pin or OPERATION command or both), bias power is removed, or another fault condition causes the unit to shut down.

0x4n The device shuts down and the unit does not attempt to retry. The output remains disabled until the part is commanded OFF then ON or the RUN pin is asserted low then high or RESET through the command or removal of VIN. The OV fault must remain active for a period of $n \cdot 10\mu\text{s}$, where n is a value from 0 to 7.

0x78+n The device shuts down and the unit attempts to retry continuously until either the fault condition is cleared or the part is commanded OFF then ON or the RUN pin is asserted low then high or RESET through the command or removal of VIN. The OV fault must remain active for a period of $n \cdot 10\mu\text{s}$, where n is a value from 0 to 7.

Any other value will result in a CML fault and the write will be ignored.

This command has one data byte.

Table 14. VOUT_OV_FAULT_RESPONSE Data Byte Contents

BITS	DESCRIPTION	VALUE	MEANING
7:6	Response For all values of bits [7:6], the LTM4664: <ul style="list-style-type: none"> • Sets the corresponding fault bit in the status commands and • Notifies the host by asserting $\overline{\text{ALERT}}$ pin, unless masked. The fault bit, once set, is cleared only when one or more of the following events occurs: <ul style="list-style-type: none"> • The device receives a CLEAR_FAULTS command. • The output is commanded through the RUN pin, the OPERATION command, or the combined action of the RUN pin and OPERATION command, to turn off and then to turn back on, or • Bias power is removed and reapplied to the LTM4664. 	00	Part performs OV pull down only or OV_PULLDOWN (i.e., turns off the top MOSFET and turns on lower MOSFET while V_{OUT} is $> V_{\text{OUT_OV_FAULT}}$).
		01	The PMBus device continues operation for the delay time specified by bits [2:0] and the delay time unit specified for that particular fault. If the fault condition is still present at the end of the delay time, the unit responds as programmed in the Retry Setting (bits [5:3]).
		10	The device shuts down immediately (disables the output) and responds according to the retry setting in bits [5:3].
		11	Not supported. Writing this value will generate a CML fault.
5:3	Retry Setting	000	The unit does not attempt to restart. The output remains disabled until the fault is cleared until the device is commanded OFF bias power is removed.
		111	The PMBus device attempts to restart continuously, without limitation, until it is commanded OFF (by the RUN pin or OPERATION command or both), bias power is removed, or another fault condition causes the unit to shut down without retry. Note: The retry interval is set by the MFR_RETRY_DELAY command.
2:0	Delay Time	000-111	The delay time in $10\mu\text{s}$ increments. This delay time determines how long the controller continues operating after a fault is detected. Only valid for deglitched off state.

VOUT_UV_FAULT_RESPONSE

The VOUT_UV_FAULT_RESPONSE command instructs the device on what action to take in response to an output undervoltage fault. The data byte is in the format given in Table 8.

The device also:

- Sets the NONE_OF_THE_ABOVE bit in the STATUS_BYTE
- Sets the VOUT bit in the STATUS_WORD
- Sets the VOUT undervoltage fault bit in the STATUS_VOUT command
- Notifies the host by asserting $\overline{\text{ALERT}}$ pin, unless masked

PMBus COMMAND DETAILS

The UV fault and warn are masked until the following criteria are achieved:

- 1) The TON_MAX_FAULT_LIMIT has been reached
- 2) The TON_DELAY sequence has completed
- 3) The TON_RISE sequence has completed
- 4) The VOUT_UV_FAULT_LIMIT threshold has been reached
- 5) The IOUT_OC_FAULT_LIMIT is not present

The UV fault and warn are masked whenever the channel is not active.

The UV fault and warn are masked during TON_RISE and TOFF_FALL sequencing.

This command has one data byte.

Table 15. VOUT_UV_FAULT_RESPONSE Data Byte Contents

BITS	DESCRIPTION	VALUE	MEANING
7:6	Response For all values of bits [7:6], the LTM4664: <ul style="list-style-type: none"> • Sets the corresponding fault bit in the status commands and • Notifies the host by asserting $\overline{\text{ALERT}}$ pin, unless masked. The fault bit, once set, is cleared only when one or more of the following events occurs: <ul style="list-style-type: none"> • The device receives a CLEAR_FAULTS command. • The output is commanded through the RUN pin, the OPERATION command, or the combined action of the RUN pin and OPERATION command, to turn off and then to turn back on, or • The device receives a RESTORE_USER_ALL command. • The device receives a MFR_RESET command. • The device supply power is cycled. 	00	The PMBus device continues operation without interruption. (Ignores the fault functionally)
		01	The PMBus device continues operation for the delay time specified by bits [2:0] and the delay time unit specified for that particular fault. If the fault condition is still present at the end of the delay time, the unit responds as programmed in the Retry Setting (bits [5:3]).
		10	The device shuts down (disables the output) and responds according to the retry setting in bits [5:3].
		11	Not supported. Writing this value will generate a CML fault.
5:3	Retry Setting	000	The unit does not attempt to restart. The output remains disabled until the fault is cleared until the device is commanded OFF bias power is removed.
		111	The PMBus device attempts to restart continuously, without limitation, until it is commanded OFF (by the RUN pin or OPERATION command or both), bias power is removed, or another fault condition causes the unit to shut down without retry. Note: The retry interval is set by the MFR_RETRY_DELAY command.
2:0	Delay Time	000-111	The delay time in 10 μ s increments. This delay time determines how long the controller continues operating after a fault is detected. Only valid for deglitched off state.

PMBus COMMAND DETAILS

TON_MAX_FAULT_RESPONSE

The TON_MAX_FAULT_RESPONSE command instructs the device on what action to take in response to a TON_MAX fault. The data byte is in the format given in Table 13.

The device also:

- Sets the NONE_OF_THE_ABOVE bit in the STATUS_BYTE
- Sets the VOUT bit in the STATUS_WORD
- Sets the TON_MAX_FAULT bit in the STATUS_VOUT command, and
- Notifies the host by asserting $\overline{\text{ALERT}}$ pin, unless masked

A value of 0 disables the TON_MAX_FAULT_RESPONSE. It is not recommended to use 0.

Note: The PWM channel remains in discontinues mode until the TON_MAX_FAULT_LIMIT has been exceeded.

This command has one data byte.

Fault Responses Output Current

COMMAND NAME	CMD CODE	DESCRIPTION	TYPE	PAGED	DATA FORMAT	UNITS	NVM	DEFAULT VALUE
IOUT_OC_FAULT_RESPONSE	0x47	Action to be taken by the device when an output overcurrent fault is detected.	R/W Byte	Y	Reg		Y	0x00

IOUT_OC_FAULT_RESPONSE

The IOUT_OC_FAULT_RESPONSE command instructs the device on what action to take in response to an output overcurrent fault. The data byte is in the format given in Table 9.

The device also:

- Sets the NONE_OF_THE_ABOVE bit in the STATUS_BYTE
- Sets the IOUT_OC bit in the STATUS_BYTE
- Sets the IOUT bit in the STATUS_WORD
- Sets the IOUT Overcurrent Fault bit in the STATUS_IOUT command, and
- Notifies the host by asserting $\overline{\text{ALERT}}$ pin, unless masked

This command has one data byte.

PMBus COMMAND DETAILS

Table 16. IOUT_OC_FAULT_RESPONSE Data Byte Contents

BITS	DESCRIPTION	VALUE	MEANING
7:6	Response For all values of bits [7:6], the LTM4664: <ul style="list-style-type: none"> • Sets the corresponding fault bit in the status commands and • Notifies the host by asserting $\overline{\text{ALERT}}$ pin, unless masked. The fault bit, once set, is cleared only when one or more of the following events occurs: <ul style="list-style-type: none"> • The device receives a CLEAR_FAULTS command. • The output is commanded through the RUN pin, the OPERATION command, or the combined action of the RUN pin and OPERATION command, to turn off and then to turn back on, or • The device receives a RESTORE_USER_ALL command. • The device receives a MFR_RESET command. • The device supply power is cycled. 	00	The LTM4664 PSM continues to operate indefinitely while maintaining the output current at the value set by IOUT_OC_FAULT_LIMIT without regard to the output voltage (known as constant-current or brick-wall limiting).
		01	Not supported.
		10	The LTM4664 PSM continues to operate, maintaining the output current at the value set by IOUT_OC_FAULT_LIMIT without regard to the output voltage, for the delay time set by bits [2:0]. If the device is still operating in current limit at the end of the delay time, the device responds as programmed by the Retry Setting in bits [5:3].
		11	The LTM4664 PSM shuts down immediately and responds as programmed by the Retry Setting in bits [5:3].
5:3	Retry Setting	000	The unit does not attempt to restart. The output remains disabled until the fault is cleared by cycling the RUN pin or removing bias power.
		111	The device attempts to restart continuously, without limitation, until it is commanded OFF (by the RUN pin or OPERATION command or both), bias power is removed, or another fault condition causes the unit to shut down. Note: The retry interval is set by the MFR_RETRY_DELAY command.
2:0	Delay Time	000-111	The number of delay time units in 16ms increments. This delay time is used to determine the amount of time a unit is to continue operating after a fault is detected before shutting down. Only valid for deglitched off response.

Fault Responses IC Temperature

COMMAND NAME	CMD CODE	DESCRIPTION	TYPE	PAGED	DATA FORMAT	UNITS	NVM	DEFAULT VALUE
MFR_OT_FAULT_RESPONSE	0xD6	Action to be taken by the device when an internal overtemperature fault is detected.	R Byte	N	Reg			0xC0

MFR_OT_FAULT_RESPONSE

The MFR_OT_FAULT_RESPONSE command byte instructs the device on what action to take in response to an internal overtemperature fault. The data byte is in the format given in Table 12.

The LTM4664 also:

- Sets the NONE_OF_THE_ABOVE bit in the STATUS_BYTE
- Sets the MFR bit in the STATUS_WORD, and
- Sets the Overtemperature Fault bit in the STATUS_MFR_SPECIFIC command
- Notifies the host by asserting $\overline{\text{ALERT}}$ pin, unless masked

This command has one data byte.

PMBus COMMAND DETAILS

Table 17. Data Byte Contents MFR_OT_FAULT_RESPONSE

BITS	DESCRIPTION	VALUE	MEANING
7:6	Response For all values of bits [7:6], the LTM4664: <ul style="list-style-type: none"> • Sets the corresponding fault bit in the status commands and • Notifies the host by asserting $\overline{\text{ALERT}}$ pin, unless masked. The fault bit, once set, is cleared only when one or more of the following events occurs: <ul style="list-style-type: none"> • The device receives a CLEAR_FAULTS command. • The output is commanded through the RUN pin, the OPERATION command, or the combined action of the RUN pin and OPERATION command, to turn off and then to turn back on, or • Bias power is removed and reapplied to the LTM4664. 	00	Not supported. Writing this value will generate a CML fault.
		01	Not supported. Writing this value will generate a CML fault
		10	The device shuts down immediately (disables the output) and responds according to the retry setting in bits [5:3].
		11	The device's output is disabled while the fault is present. Operation resumes and the output is enabled when the fault condition no longer exists.
5:3	Retry Setting	000	The unit does not attempt to restart. The output remains disabled until the fault is cleared.
		001-111	Not supported. Writing this value will generate CML fault.
2:0	Delay Time	XXX	Not supported. Value ignored

Fault Responses External Temperature

COMMAND NAME	CMD CODE	DESCRIPTION	TYPE	PAGED	DATA FORMAT	UNITS	NVM	DEFAULT VALUE
OT_FAULT_RESPONSE	0x50	Action to be taken by the device when an external overtemperature fault is detected,	R/W Byte	Y	Reg		Y	0xB8
UT_FAULT_RESPONSE	0x54	Action to be taken by the device when an external undertemperature fault is detected.	R/W Byte	Y	Reg		Y	0xB8

OT_FAULT_RESPONSE

The OT_FAULT_RESPONSE command instructs the device on what action to take in response to an external overtemperature fault on the external temp sensors. The data byte is in the format given in Table 8.

The device also:

- Sets the TEMPERATURE bit in the STATUS_BYTE
- Sets the Overtemperature Fault bit in the STATUS_TEMPERATURE command, and
- Notifies the host by asserting $\overline{\text{ALERT}}$ pin, unless masked

This command has one data byte.

UT_FAULT_RESPONSE

The UT_FAULT_RESPONSE command instructs the device on what action to take in response to an external undertemperature fault on the external temp sensors. The data byte is in the format given in Table 13.

The device also:

- Sets the TEMPERATURE bit in the STATUS_BYTE
- Sets the Undertemperature Fault bit in the STATUS_TEMPERATURE command, and
- Notifies the host by asserting $\overline{\text{ALERT}}$ pin, unless masked

PMBus COMMAND DETAILS

This condition is detected by the ADC so the response time may be up to t_{CONVERT} .

This command has one data byte.

Table 18. Data Byte Contents: TON_MAX_FAULT_RESPONSE, VIN_OV_FAULT_RESPONSE, OT_FAULT_RESPONSE, UT_FAULT_RESPONSE

BITS	DESCRIPTION	VALUE	MEANING
7:6	Response For all values of bits [7:6], the LTM4664: <ul style="list-style-type: none"> • Sets the corresponding fault bit in the status commands, and • Notifies the host by asserting $\overline{\text{ALERT}}$ pin, unless masked. The fault bit, once set, is cleared only when one or more of the following events occurs: <ul style="list-style-type: none"> • The device receives a CLEAR_FAULTS command. • The output is commanded through the RUN pin, the OPERATION command, or the combined action of the RUN pin and OPERATION command, to turn off and then to turn back on, or • The device receives a RESTORE_USER_ALL command. • The device receives a MFR_RESET command. • The device supply power is cycled. 	00	The PMBus device continues operation without interruption.
		01	Not supported. Writing this value will generate a CML fault.
		10	The device shuts down immediately (disables the output) and responds according to the retry setting in bits [5:3].
		11	Not supported. Writing this value will generate a CML fault.
5:3	Retry Setting	000	The unit does not attempt to restart. The output remains disabled until the fault is cleared until the device is commanded OFF bias power is removed.
		111	The PMBus device attempts to restart continuously, without limitation, until it is commanded OFF (by the RUN pin or OPERATION command or both), bias power is removed, or another fault condition causes the unit to shut down without retry. Note: The retry interval is set by the MFR_RETRY_DELAY command.
2:0	Delay Time	XXX	Not supported. Values ignored

FAULT SHARING

Fault Sharing Propagation

COMMAND NAME	CMD CODE	DESCRIPTION	TYPE	PAGED	DATA FORMAT	UNITS	NVM	DEFAULT VALUE
MFR_FAULT_PROPAGATE	0xD2	Configuration that determines which faults are propagated to the FAULT pins.	R/W Word	Y	Reg		Y	0x6993

MFR_FAULT_PROPAGATE

The MFR_FAULT_PROPAGATE command enables the faults that can cause the $\overline{\text{FAULT}}_n$ pin to assert low. The command is formatted as shown in Table 15. Faults can only be propagated to the $\overline{\text{FAULT}}_n$ pin if they are programmed to respond to faults.

This command has two data bytes.

PMBus COMMAND DETAILS

Table 19. FAULT_n Propagate Fault Configuration

The FAULT₀ and FAULT₁ pins are designed to provide electrical notification of selected events to the user. Some of these events are common to both output channels. Others are specific to an output channel. They can also be used to share faults between channels.

BIT(S)	SYMBOL	OPERATION
B[15]	VOUT disabled while not decayed.	This is used in a PolyPhase configuration when bit 0 of the MFR_CHAN_CONFIG_LTM4664 is a zero. If the channel is turned off, by toggling the RUN pin or commanding the part OFF, and then the RUN is reasserted or the part is commanded back on before the output has decayed, VOUT will not restart until the 12.5% decay is honored. The FAULT pin is asserted during this condition if bit 15 is asserted.
B[14]	Mfr_fault_propagate_short_CMD_cycle	0: No action 1: Asserts low if commanded off then on before the output has sequenced off. Re-asserts high t _{OFF(MIN)} after sequence off.
b[13]	Mfr_fault_propagate_ton_max_fault	0: No action if a TON_MAX_FAULT fault is asserted 1: Associated output will be asserted low if a TON_MAX_FAULT fault is asserted FAULT ₀ is associated with page 0 TON_MAX_FAULT faults FAULT ₁ is associated with page 1 TON_MAX_FAULT faults
b[12]	Reserved	
b[11]	Mfr_fault0_propagate_int_ot, Mfr_fault1_propagate_int_ot	0: No action if the MFR_OT_FAULT_LIMIT fault is asserted 1: Associated output will be asserted low if the MFR_OT_FAULT_LIMIT fault is asserted
b[10]	Reserved	
b[9]	Reserved	
b[8]	Mfr_fault0_propagate_ut, Mfr_fault1_propagate_ut	0: No action if the UT_FAULT_LIMIT fault is asserted 1: Associated output will be asserted low if the UT_FAULT_LIMIT fault is asserted FAULT ₀ is associated with page 0 UT faults FAULT ₁ is associated with page 1 UT faults
b[7]	Mfr_fault0_propagate_ot, Mfr_fault1_propagate_ot	0: No action if the OT_FAULT_LIMIT fault is asserted 1: Associated output will be asserted low if the OT_FAULT_LIMIT fault is asserted FAULT ₀ is associated with page 0 OT faults FAULT ₁ is associated with page 1 OT faults
b[6]	Reserved	
b[5]	Reserved	
b[4]	Mfr_fault0_propagate_input_ov, Mfr_fault1_propagate_input_ov	0: No action if the VIN_OV_FAULT_LIMIT fault is asserted 1: Associated output will be asserted low if the VIN_OV_FAULT_LIMIT fault is asserted
b[3]	Reserved	
b[2]	Mfr_fault0_propagate_iout_oc, Mfr_fault1_propagate_iout_oc	0: No action if the IOUT_OC_FAULT_LIMIT fault is asserted 1: Associated output will be asserted low if the IOUT_OC_FAULT_LIMIT fault is asserted FAULT ₀ is associated with page 0 OC faults FAULT ₁ is associated with page 1 OC faults
b[1]	Mfr_fault0_propagate_vout_uv, Mfr_fault1_propagate_vout_uv	0: No action if the VOUT_UV_FAULT_LIMIT fault is asserted 1: Associated output will be asserted low if the VOUT_UV_FAULT_LIMIT fault is asserted FAULT ₀ is associated with page 0 UV faults FAULT ₁ is associated with page 1 UV faults
b[0]	Mfr_fault0_propagate_vout_ov, Mfr_fault1_propagate_vout_ov	0: No action if the VOUT_OV_FAULT_LIMIT fault is asserted 1: Associated output will be asserted low if the VOUT_OV_FAULT_LIMIT fault is asserted FAULT ₀ is associated with page 0 OV faults FAULT ₁ is associated with page 1 OV faults

PMBus COMMAND DETAILS

Fault Sharing Response

COMMAND NAME	CMD CODE	DESCRIPTION	TYPE	PAGED	DATA FORMAT	UNITS	NVM	DEFAULT VALUE
MFR_FAULT_RESPONSE	0xD5	Action to be taken by the device when the FAULT pin is asserted low.	R/W Byte	Y	Reg		Y	0xC0

MFR_FAULT_RESPONSE

The MFR_FAULT_RESPONSE command instructs the device on what action to take in response to the $\overline{\text{FAULT}}_n$ pin being pulled low by an external source.

Supported Values:

VALUE	MEANING
0xC0	FAULT_INHIBIT The LTM4664 will three-state the output in response to the $\overline{\text{FAULT}}$ pin pulled low.
0x00	FAULT_IGNORE The LTM4664 continues operation without interruption.

The device also:

- Sets the MFR Bit in the STATUS_WORD.
- Sets Bit 0 in the STATUS_MFR_SPECIFIC Command to Indicate $\overline{\text{FAULT}}_n$ Is Being Pulled Low
- Notifies the Host by Asserting $\overline{\text{ALERT}}$, Unless Masked

This command has one data byte.

SCRATCHPAD

COMMAND NAME	CMD CODE	DESCRIPTION	TYPE	PAGED	DATA FORMAT	UNITS	NVM	DEFAULT VALUE
USER_DATA_00	0xB0	OEM reserved. Typically used for part serialization.	R/W Word	N	Reg		Y	NA
USER_DATA_01	0xB1	Manufacturer reserved for LTpowerPlay.	R/W Word	Y	Reg		Y	NA
USER_DATA_02	0xB2	OEM reserved. Typically used for part serialization.	R/W Word	N	Reg		Y	NA
USER_DATA_03	0xB3	A NVM word available for the user.	R/W Word	Y	Reg		Y	0x0000
USER_DATA_04	0xB4	A NVM word available for the user.	R/W Word	N	Reg		Y	0x0000

PMBus COMMAND DETAILS

USER_DATA_00 through USER_DATA_04

These commands are non-volatile memory locations for customer storage. The customer has the option to write any value to the USER_DATA_nn at any time. However, the LTpowerPlay software and contract manufacturers use some of these commands for inventory control. Modifying the reserved USER_DATA_nn commands may lead to undesirable inventory control and incompatibility with these products.

These commands have 2 data bytes and are in register format.

IDENTIFICATION

COMMAND NAME	CMD CODE	DESCRIPTION	TYPE	PAGED	DATA FORMAT	UNITS	NVM	DEFAULT VALUE
PMBus_REVISION	0x98	PMBus revision supported by this device. Current revision is 1.2.	R Byte	N	Reg		FS	0x22
CAPABILITY	0x19	Summary of PMBus optional communication protocols supported by this device.	R Byte	N	Reg			0xB0
MFR_ID	0x99	The manufacturer ID of the LTM4664 in ASCII.	R String	N	ASC			LTC
MFR_MODEL	0x9A	Manufacturer part number in ASCII.	R String	N	ASC			LTM4664
MFR_SPECIAL_ID	0xE7	Manufacturer code representing the LTM4664.	R Word	N	Reg			0x020X

PMBus_REVISION

The PMBUS_REVISION command indicates the revision of the PMBus to which the device is compliant. The LTM4664 is PMBus Version 1.2 compliant in both Part I and Part II.

This read-only command has one data byte.

CAPABILITY

This command provides a way for a host system to determine some key capabilities of a PMBus device.

The LTM4664 supports packet error checking, 400kHz bus speeds, and $\overline{\text{ALERT}}$ pin.

This read-only command has one data byte.

MFR_ID

The MFR_ID command indicates the manufacturer ID of the LTM4664 using ASCII characters.

This read-only command is in block format.

MFR_MODEL

The MFR_MODEL command indicates the manufacturer's part number of the LTM4664 using ASCII characters.

This read-only command is in block format.

MFR_SPECIAL_ID

The 16-bit word representing the part name and revision. 0x4C denotes the part is an LTM4664, XX is adjustable by the manufacturer.

This read-only command has two data bytes.

PMBus COMMAND DETAILS

FAULT WARNING AND STATUS

COMMAND NAME	CMD CODE	DESCRIPTION	TYPE	PAGED	FORMAT	UNITS	NVM	DEFAULT VALUE
CLEAR_FAULTS	0x03	Clear any fault bits that have been set.	Send Byte	N				NA
SMBALERT_MASK	0x1B	Mask activity.	Block R/W	Y	Reg		Y	See CMD Details
MFR_CLEAR_PEAKS	0xE3	Clears all peak values.	Send Byte	Y				NA
STATUS_BYTE	0x78	One byte summary of the unit's fault condition.	R/W Byte	Y	Reg			NA
STATUS_WORD	0x79	Two byte summary of the unit's fault condition.	R/W Word	Y	Reg			NA
STATUS_VOUT	0x7A	Output voltage fault and warning status.	R/W Byte	Y	Reg			NA
STATUS_IOUT	0x7B	Output current fault and warning status.	R/W Byte	Y	Reg			NA
STATUS_INPUT	0x7C	Input supply fault and warning status.	R/W Byte	N	Reg			NA
STATUS_TEMPERATURE	0x7D	External temperature fault and warning status for READ_TEMPERATURE_1.	R/W Byte	Y	Reg			NA
STATUS_CML	0x7E	Communication and memory fault and warning status.	R/W Byte	N	Reg			NA
STATUS_MFR_SPECIFIC	0x80	Manufacturer specific fault and state information.	R/W Byte	Y	Reg			NA
MFR_PADS	0xE5	Digital status of the I/O pads.	R Word	N	Reg			NA
MFR_COMMON	0xEF	Manufacturer status bits that are common across multiple ADI chips.	R Byte	N	Reg			NA

CLEAR_FAULTS

The CLEAR_FAULTS command is used to clear any fault bits that have been set. This command clears all bits in all status commands simultaneously. At the same time, the device negates (clears, releases) its $\overline{\text{ALERT}}$ pin signal output if the device is asserting the $\overline{\text{ALERT}}$ pin signal. If the fault is still present when the bit is cleared, the fault bit will remain set and the host notified by asserting the $\overline{\text{ALERT}}$ pin low. CLEAR_FAULTS can take up to 10 μ s to process. If a fault occurs within that time frame it may be cleared before the status register is set.

This write-only command has no data bytes.

The CLEAR_FAULTS does not cause a unit that has latched off for a fault condition to restart. Units that have shut down for a fault condition are restarted when:

- The output is commanded through the RUN pin, the OPERATION command, or the combined action of the RUN pin and OPERATION command, to turn off and then to turn back on, or
- MFR_RESET command is issued.
- Bias power is removed and reapplied to the integrated circuit

SMBALERT_MASK

The SMBALERT_MASK command can be used to prevent a particular status bit or bits from asserting $\overline{\text{ALERT}}$ as they are asserted.

Figure 33 shows an example of the Write Word format used to set an $\overline{\text{ALERT}}$ mask, in this case without PEC. The bits in the mask byte align with bits in the specified status register. For example, if the STATUS_TEMPERATURE command code is sent in the first data byte, and the mask byte contains 0x40, then a subsequent External Overtemperature Warning

PMBus COMMAND DETAILS

would still set bit 6 of STATUS_TEMPERATURE but not assert $\overline{\text{ALERT}}$. All other supported STATUS_TEMPERATURE bits would continue to assert $\overline{\text{ALERT}}$ if set.

Figure 50 shows an example of the Block Write – Block Read Process Call protocol used to read back the present state of any supported status register, again without PEC.

SMBALERT_MASK cannot be applied to STATUS_BYTE, STATUS_WORD, MFR_COMMON or MFR_PADS_LTM4664. Factory default masking for applicable status registers is shown below. Providing an unsupported command code to SMBALERT_MASK will generate a CML for Invalid/Unsupported Data.

SMBALERT_MASK Default Setting: (Refer Also to Figure 2)

STATUS RESISTER	ALERT Mask Value	MASKED BITS
STATUS_VOUT	0x00	None
STATUS_IOUT	0x00	None
STATUS_TEMPERATURE	0x00	None
STATUS_CML	0x00	None
STATUS_INPUT	0x00	None
STATUS_MFR_SPECIFIC	0x11	Bit 4 (internal PLL unlocked), bit 0 ($\overline{\text{FAULT}}$ pulled low by external device)

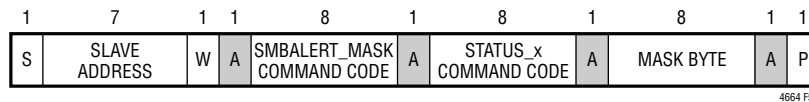

Figure 53. Example of Writing SMBALERT_MASK

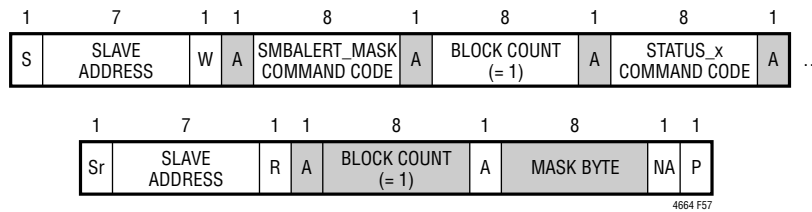

Figure 54. Example of Reading SMBALERT_MASK

MFR_CLEAR_PEAKE

The MFR_CLEAR_PEAKE command clears the MFR_*_PEAK data values. A MFR_RESET command will also clear the MFR_*_PEAK data values.

This write-only command has no data bytes.

STATUS_BYTE

The STATUS_BYTE command returns one byte of information with a summary of the most critical faults. This is the lower byte of the status word.

PMBus COMMAND DETAILS

STATUS_BYTE Message Contents:

BIT	STATUS BIT NAME	MEANING
7*	BUSY	A fault was declared because the LTM4664 was unable to respond.
6	OFF	This bit is set if the channel is not providing power to its output, regardless of the reason, including simply not being enabled.
5	VOUT_OV	An output overvoltage fault has occurred.
4	IOUT_OC	An output overcurrent fault has occurred.
3	VIN_UV	Not supported (LTM4664 returns 0).
2	TEMPERATURE	A temperature fault or warning has occurred.
1	CML	A communications, memory or logic fault has occurred.
0*	NONE OF THE ABOVE	A fault Not listed in bits[7:1] has occurred.

*ALERT can be asserted if either of these bits is set. They may be cleared by writing a 1 to their bit position in the STATUS_BYTE, in lieu of a CLEAR_FAULTS command.

This command has one data byte.

STATUS_WORD

The STATUS_WORD command returns a two-byte summary of the channel's fault condition. The low byte of the STATUS_WORD is the same as the STATUS_BYTE command.

STATUS_WORD High Byte Message Contents:

BIT	STATUS BIT NAME	MEANING
15	V _{OUT}	An output voltage fault or warning has occurred.
14	I _{OUT}	An output current fault or warning has occurred.
13	INPUT	An input voltage fault or warning has occurred.
12	MFR_SPECIFIC	A fault or warning specific to the LTM4664 has occurred.
11	POWER_GOOD#	The POWER_GOOD state is false if this bit is set.
10	FANS	Not supported (LTM4664 returns 0).
9	OTHER	Not supported (LTM4664 returns 0).
8	UNKNOWN	Not supported (LTM4664 returns 0).

If any of the bits in the upper byte are set, NONE_OF_THE_ABOVE is asserted.

This command has two data bytes.

STATUS_VOUT

The STATUS_VOUT command returns one byte of V_{OUT} status information.

STATUS_VOUT Message Contents:

BIT	MEANING
7	V _{OUT} overvoltage fault.
6	V _{OUT} overvoltage warning.
5	V _{OUT} undervoltage warning.
4	V _{OUT} undervoltage fault.
3	V _{OUT} max warning.
2	TON max fault.
1	TOFF max fault.
0	Not supported (LTM4664 returns 0).

PMBus COMMAND DETAILS

The user is permitted to write a 1 to any bit in this command to clear a specific fault. This permits the user to clear status by means other than using the CLEAR_FAULTS command.

Any supported fault bit in this command will initiate an $\overline{\text{ALERT}}$ event.

This command has one data byte.

STATUS_IOUT

The STATUS_IOUT command returns one byte of I_{OUT} status information.

STATUS_IOUT Message Contents:

BIT	MEANING
7	I _{OUT} overcurrent fault.
6	Not supported (LTM4664 returns 0).
5	I _{OUT} overcurrent warning.
4:0	Not supported (LTM4664 returns 0).

The user is permitted to write a 1 to any bit in this command to clear a specific fault. This permits the user to clear status by means other than using the CLEAR_FAULTS command.

Any supported fault bit in this command will initiate an $\overline{\text{ALERT}}$ event. This command has one data byte.

STATUS_INPUT

The STATUS_INPUT command returns one byte of V_{IN} (VINS3_C1) status information.

STATUS_INPUT Message Contents:

BIT	MEANING
7	V _{IN} overvoltage fault.
6	Not supported (LTM4664 returns 0).
5	V _{IN} undervoltage warning.
4	Not supported (LTM4664 returns 0).
3	Unit off for insufficient V _{IN} .
2	Not supported (LTM4664 returns 0).
1	I _{IN} overcurrent warning.
0	Not supported (LTM4664 returns 0).

The user is permitted to write a 1 to any bit in this command to clear a specific fault. This permits the user to clear status by means other than using the CLEAR_FAULTS command.

Any supported fault bit in this command will initiate an $\overline{\text{ALERT}}$ event. Bit 3 of this command is not latched and will not generate an $\overline{\text{ALERT}}$ even if it is set. This command has one data byte.

PMBus COMMAND DETAILS

STATUS_TEMPERATURE

The STATUS_TEMPERATURE command returns one byte with status information on temperature. This is a paged command and is related to the respective READ_TEMPERATURE_1 value.

STATUS_TEMPERATURE Message Contents:

BIT	MEANING
7	External overtemperature fault.
6	External overtemperature warning.
5	Not supported (LTM4664 returns 0).
4	External undertemperature fault.
3:0	Not supported (LTM4664 returns 0).

The user is permitted to write a 1 to any bit in this command to clear a specific fault. This permits the user to clear status by means other than using the CLEAR_FAULTS command.

This command has one data byte.

STATUS_CML

The STATUS_CML command returns one byte of status information on received commands, internal memory and logic.

STATUS_CML Message Contents:

BIT	MEANING
7	Invalid or unsupported command received.
6	Invalid or unsupported data received.
5	Packet error check failed.
4	Memory fault detected.
3	Processor fault detected.
2	Reserved (LTM4664 returns 0).
1	Other communication fault.
0	Other memory or logic fault.

If either bit 3 or bit 4 of this command is set, a serious and significant internal error has been detected. Continued operation of the part is not recommended if these bits are continuously set.

The user is permitted to write a 1 to any bit in this command to clear a specific fault. This permits the user to clear status by means other than using the CLEAR_FAULTS command.

Any supported fault bit in this command will initiate an $\overline{\text{ALERT}}$ event.

This command has one data byte.

PMBus COMMAND DETAILS

STATUS_MFR_SPECIFIC

The STATUS_MFR_SPECIFIC commands returns one byte with the manufacturer specific status information.

The format for this byte is:

BIT	MEANING
7	Internal Temperature Fault Limit Exceeded.
6	Internal Temperature Warn Limit Exceeded.
5	Factory Trim Area NVM CRC Fault.
4	PLL is Unlocked
3	Fault Log Present
2	V _{DD33} UV or OV Fault
1	ShortCycle Event Detected
0	FAULT Pin Asserted Low by External Device

If any of these bits are set, the MFR bit in the STATUS_WORD will be set, and $\overline{\text{ALERT}}$ may be asserted.

The user is permitted to write a 1 to any bit in this command to clear a specific fault. This permits the user to clear status by means other than using the CLEAR_FAULTS command. However, the fault log present bit can only be cleared by issuing the MFR_FAULT_LOG_CLEAR command.

Any supported fault bit in this command will initiate an $\overline{\text{ALERT}}$ event.

This command has one data byte.

MFR_PADS

This command provides the user a means of directly reading the digital status of the I/O pins of the device. The bit assignments of this command are as follows:

BIT	ASSIGNED DIGITAL PIN
15	V _{DD33} OV Fault
14	V _{DD33} UV Fault
13	Reserved
12	Reserved
11	ADC Values Invalid, Occurs During Start-Up. May Occur Briefly on Current Measurement Channels During Normal Operation
10	SYNC clocked by external device (when LTM4664 configured to drive SYNC pin)
9	Channel 1 Power Good
8	Channel 0 Power Good
7	LTM4664 Driving RUN1 Low
6	LTM4664 Driving RUN0 Low
5	RUN1 Pin State
4	RUN0 Pin State
3	LTM4664 Driving $\overline{\text{FAULT1}}$ Low
2	LTM4664 Driving $\overline{\text{FAULT0}}$ Low
1	$\overline{\text{FAULT1}}$ Pin State
0	$\overline{\text{FAULT0}}$ Pin State

A 1 indicates the condition is true.

This read-only command has two data bytes.

PMBus COMMAND DETAILS

MFR_COMMON

The MFR_COMMON command contains bits that are common to all ADI digital power and telemetry products.

BIT	MEANING
7	Chip Not Driving ALERT Low
6	LTM4664 Not Busy
5	Calculations Not Pending
4	LTM4664 Outputs Not in Transition
3	NVM Initialized
2	Reserved
1	SHARE_CLK Timeout
0	WP Pin Status

This read-only command has one data byte.

MFR_INFO

The MFR_INFO command contains additional status bits that are LTC3884-specific and may be common to multiple ADI PSM products.

MFR_INFO Data Contents:

BIT	MEANING
15:5	Reserved.
4	EEPROM ECC status. 0: Corrections made in the EEPROM user space. 1: No corrections made in the EEPROM user space.
3:0	Reserved

EEPROM ECC status is updated after each RESTORE_USER_ALL or RESET command, a power-on reset or an EEPROM bulk read operation. This read-only command has two data bytes.

PMBus COMMAND DETAILS

TELEMETRY

COMMAND NAME	CMD CODE	DESCRIPTION	TYPE	PAGED	FORMAT	UNITS	NVM	DEFAULT VALUE
READ_VIN	0x88	Measured input supply voltage.	R Word	N	L11	V		NA
READ_IIN	0x89	Measured input supply current.	R Word	N	L11	A		NA
READ_VOUT	0x8B	Measured output voltage.	R Word	Y	L16	V		NA
READ_IOUT	0x8C	Measured output current.	R Word	Y	L11	A		NA
READ_TEMPERATURE_1	0x8D	Power stage diode junction temperature. This is the value used for all temperature related processing, including MFR_IOUT_CAL_GAIN.	R Word	Y	L11	C		NA
READ_TEMPERATURE_2	0x8E	Power stage junction temperature. Does not affect any other commands.	R Word	N	L11	C		NA
READ_FREQUENCY	0x95	Measured PWM switching frequency.	R Word	Y	L11	Hz		NA
READ_POUT	0x96	Calculated output power.	R Word	Y	L11	W		NA
READ_PIN	0x97	Calculated input power.	R Word	N	L11	W		NA
MFR_PIN_ACCURACY	0xAC	Returns the accuracy of the READ_PIN command	R Byte	N		%		5.0%
MFR_IOUT_PEAK	0xD7	Report the maximum measured value of READ_IOUT since last MFR_CLEAR_PEAKS.	R Word	Y	L11	A		NA
MFR_VOUT_PEAK	0xDD	Maximum measured value of READ_VOUT since last MFR_CLEAR_PEAKS.	R Word	Y	L16	V		NA
MFR_VIN_PEAK	0xDE	Maximum measured value of READ_VIN since last MFR_CLEAR_PEAKS.	R Word	N	L11	V		NA
MFR_TEMPERATURE_1_PEAK	0xDF	Maximum measured value of external Temperature (READ_TEMPERATURE_1) since last MFR_CLEAR_PEAKS.	R Word	Y	L11	C		NA
MFR_READ_IIN_PEAK	0xE1	Maximum measured value of READ_IIN command since last MFR_CLEAR_PEAKS.	R Word	N	L11	A		NA
MFR_READ_ICHIP	0xE4	Measured current used by the LTM4664.	R Word	N	L11	A		NA
MFR_TEMPERATURE_2_PEAK	0xF4	Peak internal die temperature since last MFR_CLEAR_PEAKS.	R Word	N	L11	C		NA
MFR_ADC_CONTROL	0xD8	ADC telemetry parameter selected for repeated fast ADC read back.	R/W Byte	N	N	Reg		NA

PMBus COMMAND DETAILS

READ_VIN

The READ_VIN command returns the measured V_{IN} pin voltage, in volts added to $READ_ICHIP \cdot MFR_RVIN$. This compensates for the IR voltage drop across the V_{IN} filter element due to the supply current of the LTM4664.

This read-only command has two data bytes and is formatted in Linear_5s_11s format.

READ_VOUT

The READ_VOUT command returns the measured output voltage by the VOUT_MODE command.

This read-only command has two data bytes and is formatted in Linear_16u format.

READ_IIN

The READ_IIN command returns the input current, in Amperes, as measured across the input current sense resistor (see also MFR_IIN_CAL_GAIN).

This read-only command has two data bytes and is formatted in Linear_5s_11s format.

READ_IOUT

The READ_IOUT command returns the average output current in amperes. The IOUT value is a function of:

- a) the differential voltage measured across the I_{SENSE} pins
- b) the MFR_IOUT_CAL_GAIN value
- c) the MFR_IOUT_CAL_GAIN_TC value, and
- d) READ_TEMPERATURE_1 value
- e) The MFR_TEMP_1_GAIN and the MFR_TEMP_1_OFFSET

This read-only command has two data bytes and is formatted in Linear_5s_11s format.

READ_TEMPERATURE_1

The READ_TEMPERATURE_1 command returns the temperature, in degrees Celsius, of the power stage sense element.

This read-only command has two data bytes and is formatted in Linear_5s_11s format.

READ_TEMPERATURE_2

The READ_TEMPERATURE_2 command returns the LTM4664's die temperature, in degrees Celsius, of the internal sense element.

This read-only command has two data bytes and is formatted in Linear_5s_11s format.

READ_FREQUENCY

The READ_FREQUENCY command is a reading of the PWM switching frequency in kHz.

This read-only command has 2 data bytes and is formatted in Linear_5s_11s format.

READ_POUT

The READ_POUT command is a reading of the DC/DC converter output power in Watts. POUT is calculated based on the most recent correlated output voltage and current reading.

This read-only command has 2 data bytes and is formatted in Linear_5s_11s format.

PMBus COMMAND DETAILS

READ_PIN

The READ_PIN command is a reading of the DC/DC converter input power in Watts. PIN is calculated based on the most recent input voltage and current reading.

This read-only command has 2 data bytes and is formatted in Linear_5s_11s format.

MFR_PIN_ACCURACY

The MFR_PIN_ACCURACY command returns the accuracy, in percent, of the value returned by the READ_PIN command. There is one data byte. The value is 0.1% per bit which gives a range of $\pm 0.0\%$ to $\pm 25.5\%$.

This read-only command has one data byte and is formatted as an unsigned integer.

MFR_IOUT_PEAK

The MFR_IOUT_PEAK command reports the highest current, in amperes, reported by the READ_IOUT measurement. This command is cleared using the MFR_CLEAR_PEAKS command.

This read-only command has two data bytes and is formatted in Linear_5s_11s format.

MFR_VOUT_PEAK

The MFR_VOUT_PEAK command reports the highest voltage, in volts, reported by the READ_VOUT measurement. This command is cleared using the MFR_CLEAR_PEAKS command.

This read-only command has two data bytes and is formatted in Linear_16u format.

MFR_VIN_PEAK

The MFR_VIN_PEAK command reports the highest voltage, in volts, reported by the READ_VIN measurement. This command is cleared using the MFR_CLEAR_PEAKS command.

This read-only command has two data bytes and is formatted in Linear_5s_11s format.

MFR_TEMPERATURE_1_PEAK

The MFR_TEMPERATURE_1_PEAK command reports the highest temperature, in degrees Celsius, reported by the READ_TEMPERATURE_1 measurement.

This command is cleared using the MFR_CLEAR_PEAKS command.

This read-only command has two data bytes and is formatted in Linear_5s_11s format.

MFR_READ_IIN_PEAK

The MFR_READ_IIN_PEAK command reports the highest current, in Amperes, reported by the READ_IIN measurement. This command is cleared using the MFR_CLEAR_PEAKS command.

This command has two data bytes and is formatted in Linear_5s_11s format.

MFR_READ_ICHIP

The MFR_READ_ICHIP command returns the measured input current, in Amperes, used by the LTM4664.

This command has two data bytes and is formatted in Linear_5s_11s format.

PMBus COMMAND DETAILS

MFR_TEMPERATURE_2_PEAK

The MFR_TEMPERATURE_2_PEAK command reports the highest temperature, in degrees Celsius, reported by the READ_TEMPERATURE_2 measurement.

This command is cleared using the MFR_CLEAR_PEAKS command.

This read-only command has two data bytes and is formatted in Linear_5s_11s format.

MFR_ADC_CONTROL

The MFR_ADC_CONTROL command determines the ADC read back selection. A default value of 0 in the command runs the standard telemetry loop with all parameters updated in a round robin fashion with a typical latency of t_{CONVERT} . The user can command a non-zero value to monitor a single parameter with an approximate update rate of 8ms. This command has a latency of up to 2 ADC conversions or approximately 16ms (external temperature conversions may have a latency of up to 3 ADC conversion or approximately 24ms). It is recommended the part remain in standard telemetry mode except for special cases where fast ADC updates of a single parameter is required. The part should be commanded to monitor the desired parameter for a limited period of time (less than 1 second) then set the command back to standard round robin mode. If this command is set to any value except standard round robin telemetry (0) all warnings and faults associated with telemetry other than the selected parameter are effectively disabled and voltage servoing is disabled. When round robin is reasserted, all warnings and faults and servo mode are re-enabled.

COMMANDED VALUE	TELEMETRY COMMAND NAME	DESCRIPTION
0x0F		Reserved
0x0E		Reserved
0x0D		Reserved
0x0C	READ_TEMPERATURE_1	Channel 1 external temperature
0x0B		Reserved
0x0A	READ_IOUT	Channel 1 measured output current
0x09	READ_VOUT	Channel 1 measured output voltage
0x08	READ_TEMPERATURE_1	Channel 0 external temperature
0x07		Reserved
0x06	READ_IOUT	Channel 0 measured output current
0x05	READ_VOUT	Channel 0 measured output voltage
0x04	READ_TEMPERATURE_2	Internal junction temperature
0x03	READ_IIN	Measured input supply current
0x02	MFR_READ_ICHIP	Measured supply current of the LTM4664
0x01	READ_VIN	Measured input supply voltage
0x00		Standard ADC Round Robin Telemetry

If a reserved command value is entered, the telemetry will default to Internal IC Temperature and issue a CML fault. CML faults will continue to be issued by the LTM4664 until a valid command value is entered. The accuracy of the measured input supply voltage is only guaranteed if the MFR_ADC_CONTROL command is set to standard round robin telemetry. This write-only command has 1 data byte and is formatted in register format.

PMBus COMMAND DETAILS

NVM MEMORY COMMANDS

Store/Restore

COMMAND NAME	CMD CODE	DESCRIPTION	TYPE	PAGED	FORMAT	UNITS	NVM	DEFAULT VALUE
STORE_USER_ALL	0x15	Store user operating memory to EEPROM.	Send Byte	N				NA
RESTORE_USER_ALL	0x16	Restore user operating memory from EEPROM.	Send Byte	N				NA
MFR_COMPARE_USER_ALL	0xF0	Compares current command contents with NVM.	Send Byte	N				NA

STORE_USER_ALL

The STORE_USER_ALL command instructs the PMBus device to copy the non-volatile user contents of the Operating Memory to the matching locations in the non-volatile User NVM memory.

Executing this command if the die temperature exceeds 85°C or is below 0°C is not recommended and the data retention of 10 years cannot be guaranteed. If the die temperature exceeds 130°C, the STORE_USER_ALL command is disabled. The command is re-enabled when the IC temperature drops below 125°C.

Communication with the LTM4664 and programming of the NVM can be initiated when EXT_VCC or VDD33 is available and VIN is not applied. To enable the part in this state, using global address 0x5B write MFR_EE_UNLOCK to 0x2B followed by 0xC4. The LTM4664 will now communicate normally, and the project file can be updated. To write the updated project file to the NVM issue a STORE_USER_ALL command. When VIN is applied, a MFR_RESET must be issued to allow the PWM to be enabled and valid ADCs to be read.

This write-only command has no data bytes.

RESTORE_USER_ALL

The RESTORE_USER_ALL command instructs the LTM4664 to copy the contents of the non-volatile User memory to the matching locations in the Operating Memory. The values in the Operating Memory are overwritten by the value retrieved from the User commands. The LTM4664 ensures both channels are off, loads the operating memory from the internal EEPROM, clears all faults, reads the resistor configuration pins, and then performs a soft-start of both PWM channels if applicable.

STORE_USER_ALL, MFR_COMPARE_USER_ALL and RESTORE_USER_ALL commands are disabled if the die exceeds 130°C and are not re-enabled until the die temperature drops below 125°C.

This write-only command has no data bytes.

MFR_COMPARE_USER_ALL

The MFR_COMPARE_USER_ALL command instructs the PMBus device to compare current command contents with what is stored in non-volatile memory. If the compare operation detects differences, a CML bit 0 fault will be generated.

This write-only command has no data bytes.

PMBus COMMAND DETAILS

Fault Logging

COMMAND NAME	CMD CODE	DESCRIPTION	TYPE	PAGED	DATA FORMAT	UNITS	NVM	DEFAULT VALUE
MFR_FAULT_LOG	0xEE	Fault log data bytes.	R Block	N	CF		Y	NA
MFR_FAULT_LOG_STORE	0xEA	Command a transfer of the fault log from RAM to EEPROM.	Send Byte	N				NA
MFR_FAULT_LOG_CLEAR	0xEC	Initialize the EEPROM block reserved for fault logging.	Send Byte	N				NA

MFR_FAULT_LOG

The MFR_FAULT_LOG command allows the user to read the contents of the FAULT_LOG after the first fault occurrence since the last MFR_FAULT_LOG_CLEAR command was written. The contents of this command are stored in non-volatile memory, and are cleared by the MFR_FAULT_LOG_CLEAR command. The length and content of this command are listed in Table 15. If the user accesses the MFR_FAULT_LOG command and no fault log is present, the command will return a data length of 0. If a fault log is present, the MFR_FAULT_LOG will return a block of data 147 bytes long. If a fault occurs within the first second of applying power, some of the earlier pages in the fault log may not contain valid data.

NOTE: The approximate transfer time for this command is 3.4ms using a 400kHz clock.

This read-only command is in block format.

MFR_FAULT_LOG_STORE

The MFR_FAULT_LOG_STORE command forces the fault log operation to be written to NVM just as if a fault event occurred. This command will set bit 3 of the STATUS_MFR_SPECIFIC fault if bit 7 “Enable Fault Logging” is set in the MFR_CONFIG_ALL command.

If the die temperature exceeds 130°C, the MFR_FAULT_LOG_STORE command is disabled until the IC temperature drops below 125°C.

This write-only command has no data bytes.

PMBus COMMAND DETAILS

Table 20. Fault Logging

This table outlines the format of the block data from a read block data of the MFR_FAULT_LOG command.

Data Format Definitions				LIN 11 = PMBus = Rev 1.2, Part 2, section 7.1
				LIN 16 = PMBus Rev 1.2, Part 2, section 8. Mantissa portion only
				BYTE = 8 bits interpreted per definition of this command
DATA	BITS	DATA FORMAT	BYTE NUM	BLOCK READ COMMAND
Block Length		BYTE	147	The MFR_FAULT_LOG command is a fixed length of 147 bytes The block length will be zero if a data log event has not been captured
HEADER INFORMATION				
Fault Log Preface	[7:0]	ASC	0	Returns LTx beginning at byte 0 if a partial or complete fault log exists. Word xx is a factory identifier that may vary part to part.
	[7:0]		1	
	[15:8]	Reg	2	
	[7:0]		3	
Fault Source	[7:0]	Reg	4	Refer to Table 16.
MFR_REAL_TIME	[7:0]	Reg	5	48 bit share-clock counter value when fault occurred (200µs resolution).
	[15:8]		6	
	[23:16]		7	
	[31:24]		8	
	[39:32]		9	
	[47:40]		10	
MFR_VOUT_PEAK (PAGE 0)	[15:8]	L16	11	Peak READ_VOUT on Channel 0 since last power-on or CLEAR_PEAKS command.
	[7:0]		12	
MFR_VOUT_PEAK (PAGE 1)	[15:8]	L16	13	Peak READ_VOUT on Channel 1 since last power-on or CLEAR_PEAKS command.
	[7:0]		14	
MFR_IOUT_PEAK (PAGE 0)	[15:8]	L11	15	Peak READ_IOUT on Channel 0 since last power-on or CLEAR_PEAKS command.
	[7:0]		16	
MFR_IOUT_PEAK (PAGE 1)	[15:8]	L11	17	Peak READ_IOUT on Channel 1 since last power-on or CLEAR_PEAKS command.
	[7:0]		18	
MFR_VIN_PEAK	[15:8]	L11	19	Peak READ_VIN since last power-on or CLEAR_PEAKS command.
	[7:0]		20	
READ_TEMPERATURE1 (PAGE 0)	[15:8]	L11	21	External temperature sensor 0 during last event.
	[7:0]		22	
READ_TEMPERATURE1 (PAGE 1)	[15:8]	L11	23	External temperature sensor 1 during last event.
	[7:0]		24	
READ_TEMPERATURE2	[15:8]	L11	25	LTM4664 die temperature sensor during last event.
	[7:0]		26	

PMBus COMMAND DETAILS

CYCLICAL DATA

EVENT n (Data at Which Fault Occurred; Most Recent Data)				Event “n” represents one complete cycle of ADC reads through the MUX at time of fault. Example: If the fault occurs when the ADC is processing step 15, it will continue to take readings through step 25 and then store the header and all 6 event pages to EEPROM
READ_VOUT (PAGE 0)	[15:8]	LIN 16	27	
	[7:0]	LIN 16	28	
READ_VOUT (PAGE 1)	[15:8]	LIN 16	29	
	[7:0]	LIN 16	30	
READ_IOUT (PAGE 0)	[15:8]	LIN 11	31	
	[7:0]	LIN 11	32	
READ_IOUT (PAGE 1)	[15:8]	LIN 11	33	
	[7:0]	LIN 11	34	
READ_VIN	[15:8]	LIN 11	35	
	[7:0]	LIN 11	36	
READ_IIN	[15:8]	LIN 11	37	
	[7:0]	LIN 11	38	
STATUS_VOUT (PAGE 0)		BYTE	39	
STATUS_VOUT (PAGE 1)		BYTE	40	
STATUS_WORD (PAGE 0)	[15:8]	WORD	41	
	[7:0]	WORD	42	
STATUS_WORD (PAGE 1)	[15:8]	WORD	43	
	[7:0]	WORD	44	
STATUS_MFR_SPECIFIC (PAGE 0)		BYTE	45	
STATUS_MFR_SPECIFIC (PAGE 1)		BYTE	46	
EVENT n-1 (data measured before fault was detected)				
READ_VOUT (PAGE 0)	[15:8]	LIN 16	47	
	[7:0]	LIN 16	48	
READ_VOUT (PAGE 1)	[15:8]	LIN 16	49	
	[7:0]	LIN 16	50	
READ_IOUT (PAGE 0)	[15:8]	LIN 11	51	
	[7:0]	LIN 11	52	
READ_IOUT (PAGE 1)	[15:8]	LIN 11	53	
	[7:0]	LIN 11	54	
READ_VIN	[15:8]	LIN 11	55	
	[7:0]	LIN 11	56	
READ_IIN	[15:8]	LIN 11	57	
	[7:0]	LIN 11	58	
STATUS_VOUT (PAGE 0)		BYTE	59	
STATUS_VOUT (PAGE 1)		BYTE	60	
STATUS_WORD (PAGE 0)	[15:8]	WORD	61	
	[7:0]	WORD	62	
STATUS_WORD (PAGE 1)	[15:8]	WORD	63	
	[7:0]	WORD	64	
STATUS_MFR_SPECIFIC (PAGE 0)		BYTE	65	
STATUS_MFR_SPECIFIC (PAGE 1)		BYTE	66	

PMBus COMMAND DETAILS

EVENT n-5 (Oldest Recorded Data)				
READ_VOUT (PAGE 0)	[15:8]	LIN 16	127	
	[7:0]	LIN 16	128	
READ_VOUT (PAGE 1)	[15:8]	LIN 16	129	
	[7:0]	LIN 16	130	
READ_IOUT (PAGE 0)	[15:8]	LIN 11	131	
	[7:0]	LIN 11	132	
READ_IOUT (PAGE 1)	[15:8]	LIN 11	133	
	[7:0]	LIN 11	134	
READ_VIN	[15:8]	LIN 11	135	
	[7:0]	LIN 11	136	
READ_IIN	[15:8]	LIN 11	137	
	[7:0]	LIN 11	138	
STATUS_VOUT (PAGE 0)		BYTE	139	
STATUS_VOUT (PAGE 1)		BYTE	140	
STATUS_WORD (PAGE 0)	[15:8]	WORD	141	
	[7:0]	WORD	142	
STATUS_WORD (PAGE 1)	[15:8]	WORD	143	
	[7:0]	WORD	144	
STATUS_MFR_SPECIFIC (PAGE 0)		BYTE	145	
STATUS_MFR_SPECIFIC (PAGE 1)		BYTE	146	

Table 21. Explanation of Position_Fault Values

POSITION_FAULT VALUE	SOURCE OF FAULT LOG
0xFF	MFR_FAULT_LOG_STORE
0x00	TON_MAX_FAULT
0x01	VOUT_OV_FAULT
0x02	VOUT_UV_FAULT
0x03	IOUT_OC_FAULT
0x05	TEMP_OT_FAULT
0x06	TEMP_UT_FAULT
0x07	VIN_OV_FAULT
0x0A	MFR_TEMP_2_OT_FAULT

PMBus COMMAND DETAILS

MFR_INFO

Contact the factory for details.

MFR_IOUT_CAL_GAIN

Contact the factory for details.

MFR_FAULT_LOG_CLEAR

The MFR_FAULT_LOG_CLEAR command will erase the fault log file stored values. It will also clear bit 3 in the STATUS_MFR_SPECIFIC command. After a clear is issued, the status can take up to 8ms to clear.

This write-only command is send bytes.

Block Memory Write/Read

COMMAND NAME	CMD CODE	DESCRIPTION	TYPE	PAGED	DATA FORMAT	UNITS	NVM	DEFAULT VALUE
MFR_EE_UNLOCK	0xBD	Unlock user EEPROM for access by MFR_EE_ERASE and MFR_EE_DATA commands.	R/W Byte	N	Reg			NA
MFR_EE_ERASE	0xBE	Initialize user EEPROM for bulk programming by MFR_EE_DATA.	R/W Byte	N	Reg			NA
MFR_EE_DATA	0xBF	Data transferred to and from EEPROM using sequential PMBus word reads or writes. Supports bulk programming.	R/W Word	N	Reg			NA

All the NVM commands are disabled if the die temperature exceeds 130°C. NVM commands are re-enabled when the die temperature drops below 125°C.

MFR_EE_xxxx

The MFR_EE_xxxx commands facilitate bulk programming of the LTM4664 internal EEPROM. Contact the factory for details.

PACKAGE DESCRIPTION

PACKAGE ROW AND COLUMN LABELING MAY VARY AMONG μ Module PRODUCTS. REVIEW EACH PACKAGE LAYOUT CAREFULLY.



Table 22. LTM4664Y Pin Out Array BGA

PIN ID	FUNCTION	PIN ID	FUNCTION	PIN ID	FUNCTION	PIN ID	FUNCTION	PIN ID	FUNCTION	PIN ID	FUNCTION	PIN ID	FUNCTION	PIN ID	FUNCTION	PIN ID	FUNCTION	PIN ID	FUNCTION
A1	V _{OUTC1}	B1	GND	C1	V _{INS2}	D1	SW3	E1	GND	F1	GND	G1	SW4	H1	V _{OUT2}				
A2	V _{OUTC1}	B2	GND	C2	V _{INS2}	D2	SW3	E2	GND	F2	GND	G2	SW4	H2	V _{OUT2}				
A3	V _{OUTC1}	B3	GND	C3	V _{INS2}	D3	SW3	E3	GND	F3	GND	G3	SW4	H3	V _{OUT2}				
A4	V _{OUTC1}	B4	V _{OUTC1}	C4	GND	D4	GND	E4	GND	F4	GND	G4	GND	H4	GND				
A5	V _{OUTC1}	B5	V _{OUTC1}	C5	GND	D5	V _{INS2F}	E5	HYS_PRGMS2	F5	TIMERS2	G5	FREQS2	H5	PGOODS2				
A6	V _{OUTC1}	B6	V _{OUTC1}	C6	GND	D6	I _{NSNS2} ⁻	E6	OVP_SET	F6	VOUT2_SET	G6	RUNS2	H6	FAULTS2				
A7	V _{OUTC1}	B7	V _{OUTC1}	C7	GND	D7	I _{NSNS2} ⁺	E7	OVP_TRIP	F7	EXTV _{CCS2}	G7	INTV _{CCS2}	H7	UVS2				
A8	GND	B8	GND	C8	GND	D8	GND	E8	GND	F8	GND	G8	GND	H8	FSWPH_CFG				
A9	GND	B9	GND	C9	GND	D9	GND	E9	GND	F9	GND	G9	GND	H9	GND				
A10	V _{OUTC0}	B10	V _{OUTC0}	C10	GND	D10	INTV _{CCS1}	E10	UVS1	F10	GND	G10	GND	H10	GND				
A11	V _{OUTC0}	B11	V _{OUTC0}	C11	GND	D11	EXTV _{CCS1}	E11	FAULTST	F11	RUNS1	G11	GND	H11	GND				
A12	V _{OUTC0}	B12	V _{OUTC0}	C12	GND	D12	PGOODS1	E12	FREQS1	F12	TIMERS1	G12	HYS_PRGMS1	H12					
A13	V _{OUTC0}	B13	V _{OUTC0}	C13	GND	D13	GND	E13	GND	F13	GND	G13	GND	H13					
A14	V _{OUTC0}	B14	GND	C14	V _{OUT1}	D14	SW2	E14	GND	F14	GND	G14	SW1	H14					
A15	V _{OUTC0}	B15	GND	C15	V _{OUT1}	D15	SW2	E15	GND	F15	GND	G15	SW1	H15					
A16	V _{OUTC0}	B16	GND	C16	V _{OUT1}	D16	SW2	E16	GND	F16	GND	G16	SW1	H16					
J1	GND	K1	GND	L1	V _{INS3_C1}	M1	V _{INS3_C1}	N1	GND	P1	GND	R1	GND	T1	TSNS_C1b				
J2	GND	K2	GND	L2	V _{INS3_C1}	M2	V _{INS3_C1}	N2	GND	P2	GND	R2	GND	T2	GND				
J3	GND	K3	GND	L3	GND	M3	GND	N3	GND	P3	GND	R3	GND	T3	GND				
J4	GND	K4	GND	L4	PWM_C1	M4	GND	N4	GND	P4	GND	R4	GND	T4	SWC1				
J5	VTRIMC1_CFG	K5	VTRIMC0_CFG	L5	PHFLT_C1	M5	GND	N5	PGOOD_C1	P5	GL_C1	R5	GND	T5	SWC1				
J6	VOUTC0_CFG	K6	V _{DD25}	L6	V _{DD33}	M6	COMP_1a	N6	V _{OSNS_C1}	P6	V _{OSNS_C1}	R6	GND	T6	SWC1				
J7	VOUTC1_CFG	K7	WP	L7	SHARE_CLK	M7	COMP_1b	N7	GND	P7	GND	R7	INTV _{CC}	T7	SWC1				
J8	ASEL	K8	RUN_C1	L8	SDA	M8	SDA	N8	SGND_C0_C1	P8	SGND_C0_C1	R8	EXTV _{CC}	T8	GND				
J9	RUN_C0	K9	FAULT_C1	L9	SCL	M9	SGND_C0_C1	N9	SGND_C0_C1	P9	GND	R9	GND	T9	GND				
J10	ALERT	K10	FAULT_C0	L10	TSNS_C0a	M10	TSNS_C1a	N10	COMP_0b	P10	IN ⁻	R10	IN ⁺	T10	SWC0				
J11	GND	K11	GND	L11	GND	M11	GND	N11	COMP_0a	P11	COMP_0a	R11	PGOOD_C0	T11	SWC0				
J12		K12		L12	V _{INS3_C0}	M12	V _{INS3_C0}	N12	GND	P12	V _{OSNS_C0}	R12	V _{OSNS_C0}	T12	SWC0				
J13	I _{NSNS1} ⁻	K13		L13	V _{INS3_C0}	M13	V _{INS3_C0}	N13	GND	P13	GND	R13	GND	T13	SWC0				
J14	I _{NSNS1} ⁺	K14		L14	GND	M14	GND	N14	GND	P14	GND	R14	GND	T14	GND				
J15	V _{INS1}	K15		L15	GND	M15	PWM_C0	N15	GND	P15	GND	R15	GND	T15	GND				
J16	V _{INS1}	K16		L16	GND	M16	PHFLT_C0	N16	GND	P16	GL_C0	R16	GND	T16	TSNS_C0b				

Rev. A

PACKAGE DESCRIPTION

BCA Package
240-Lead (16mm × 16mm × 7.72mm)
 (Reference LTC DWG # 05-08-1567 Rev B)

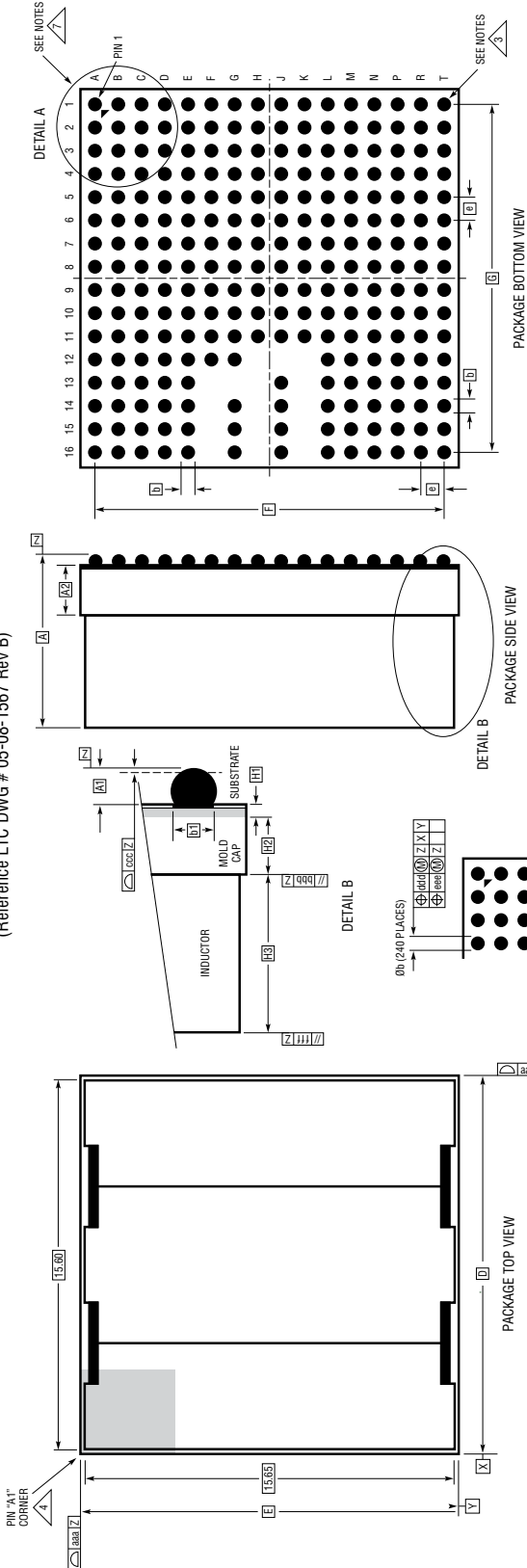

- NOTES:**
1. DIMENSIONING AND TOLERANCING PER ASME Y14.5M-1994
 2. ALL DIMENSIONS ARE IN MILLIMETERS
 3. BALL DESIGNATION PER JEDEC MS-028 AND JEFP95
 4. DETAILS OF PIN #1 IDENTIFIER ARE OPTIONAL BUT MUST BE LOCATED WITHIN THE ZONE INDICATED. THE PIN #1 IDENTIFIER MAY BE EITHER A MOLD OR MARKED FEATURE
 5. PRIMARY DATUM - Z - IS SEATING PLANE
 6. SOLDER BALL COMPOSITION CAN BE 96.5% Sn/3.0% Ag/0.5% Cu OR Sn Pb EUTECTIC
 7. PACKAGE ROW AND COLUMN LABELING MAY VARY AMONG μModule PRODUCTS. REVIEW EACH PACKAGE LAYOUT CAREFULLY

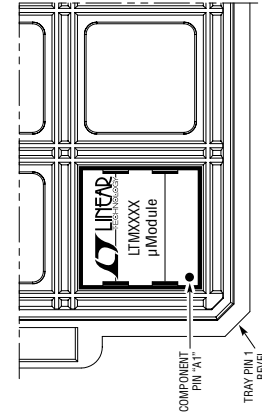

SYMBOL	DIMENSIONS		NOTES
	MIN	NOM	
A	7.41	7.72	8.03
A1	0.45	0.50	0.55
A2	1.73	1.82	1.91
b	0.50	0.60	0.70
b1	0.47	0.50	0.53
D	16.00		
E	16.00		
e	1.00		
F	15.00		
G	15.00		
H1	0.28	0.32	0.36
H2	1.45	1.50	1.55
H3	5.28	5.40	5.52
aaa	0.15		
bbb	0.10		
ccc	0.20		
ddd	0.25		
eee	0.10		
fff	0.35		
TOTAL NUMBER OF BALLS: 240			

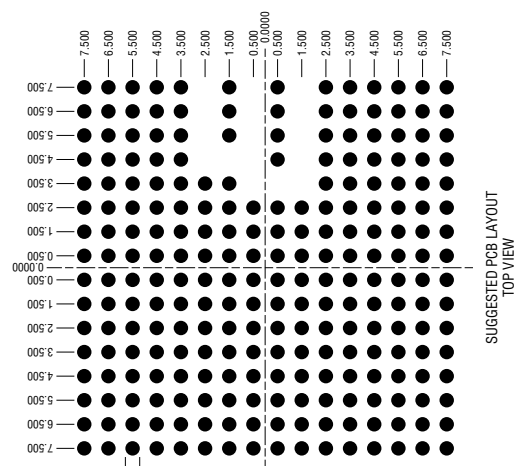

REVISION HISTORY

REV	DATE	DESCRIPTION	PAGE NUMBER
A	01/21	Device Addressing updated to four types PMBus Command Summary Table MFR_INFO CMD CODE updated to 0xB6	48 61

TYPICAL APPLICATIONS

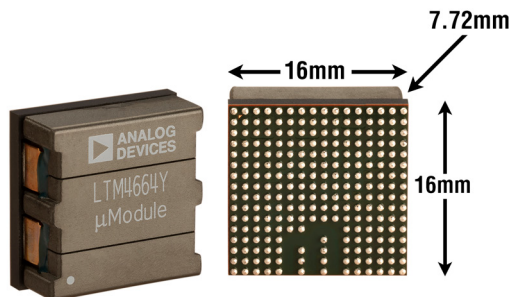

DESIGN RESOURCES

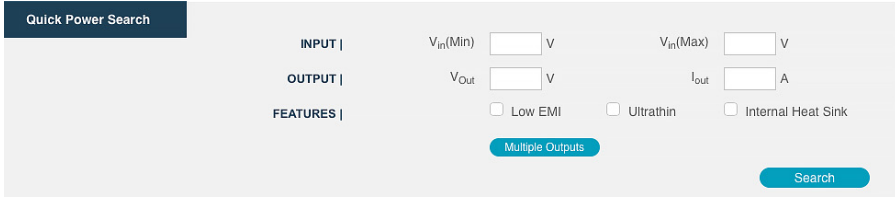
SUBJECT	DESCRIPTION	
μModule Design and Manufacturing Resources	Design: <ul style="list-style-type: none"> • Selector Guides • Demo Boards and Gerber Files • Free Simulation Tools 	Manufacturing: <ul style="list-style-type: none"> • Quick Start Guide • PCB Design, Assembly and Manufacturing Guidelines • Package and Board Level Reliability
μModule Regulator Products Search	<ol style="list-style-type: none"> 1. Sort table of products by parameters and download the result as a spread sheet. 2. Search using the Quick Power Search parametric table. 	
Digital Power System Management	Analog Devices' family of digital power supply management ICs are highly integrated solutions that offer essential functions, including power supply monitoring, supervision, margining and sequencing, and feature EEPROM for storing user configurations and fault logging.	

RELATED PARTS

PART NUMBER	DESCRIPTION	COMMENTS
LTM4622	Ultrathin, Dual 2.5A Step-Down μModule Regulator	$3.6V \leq V_{IN} \leq 20V$, $0.6V \leq V_{OUT} \leq 5.5V$, $6.25mm \times 6.25mm \times 1.82mm$ LGA, 2.42mm BGA
LTM4622A	High Vout, Ultrathin, Dual 2.5A Step-Down μModule Regulator	$3.6V \leq V_{IN} \leq 20V$, $1.5V \leq V_{OUT} \leq 12V$, $6.25mm \times 6.25mm \times 1.82mm$ LGA, 2.42mm BGA
LTM4623	Ultrathin, Single 3A μModule Regulator	$4V \leq V_{IN} \leq 20V$, $0.6V \leq V_{OUT} \leq 5.5V$, $6.25mm \times 6.25mm \times 1.82mm$ LGA, 2.42mm BGA
LTM4624	Single 4A μModule Regulator	$4V \leq V_{IN} \leq 14V$, $0.6V \leq V_{OUT} \leq 5.5V$, $6.25mm \times 6.25mm \times 5.01mm$ BGA
LTM4625	Single 5A μModule Regulator	$4V \leq V_{IN} \leq 20V$, $0.6V \leq V_{OUT} \leq 5.5V$, $6.25mm \times 6.25mm \times 5.01mm$ BGA
LTM4626	Single 12A μModule Regulator	$3.1V \leq V_{IN} \leq 20V$, $0.6V \leq V_{OUT} \leq 5.5V$, $6.25mm \times 6.25mm \times 3.87mm$ BGA
LTM4638	Single 15A μModule Regulator	$3.1V \leq V_{IN} \leq 20V$, $0.6V \leq V_{OUT} \leq 5.5V$, $6.25mm \times 6.25mm \times 5.02mm$ BGA
LTM4643	Ultrathin, Quad 3A, Step-Down μModule Regulator, Pin Compatible with LTM4644	$4V \leq V_{IN} \leq 20V$, $0.6V \leq V_{OUT} \leq 3.3V$, $9mm \times 15mm \times 1.82mm$ LGA, 2.42mm BGA
LTM4646	Dual 10A μModule Regulator	$4.5V \leq V_{IN} \leq 20V$, $0.6V \leq V_{OUT} \leq 5.5V$, $11.25mm \times 15mm \times 5.01mm$ BGA
LTC®2977	Octal Digital Power Supply Manager with EEPROM	I ² C/PMBus Interface, Configuration EEPROM, Fault Logging, 16-Bit ADC with $\pm 0.25\%$ TUE, 3.3V to 15V Operation
LTC2974	Quad Digital Power Supply Manager with EEPROM	I ² C/PMBus Interface, Configuration EEPROM, Fault Logging, Per Channel Voltage, Current and Temperature Measurements

Mouser Electronics

Authorized Distributor

Click to View Pricing, Inventory, Delivery & Lifecycle Information:

[Analog Devices Inc.:](#)

[LTM4664EY#PBF](#) [LTM4664IY#PBF](#) [DC2672A-A](#) [DC2672A-B](#)