

# Hyperfast Dual Diode

## 30 A, 400 V - 600 V

### RHRG1560CC, RHRG1540CC

#### Description

The RHRG1560CC, RHRG1540CC is a hyperfast dual diode with soft recovery characteristics. It has the half recovery time of ultrafast diodes and is silicon nitride passivated ionimplanted epitaxial planar construction.

These devices are intended to be used as freewheeling/clamping diodes and diodes in a variety of switching power supplies and other power switching applications. Their low stored charge and hyperfast soft recovery minimize ringing and electrical noise in many power switching circuits reducing power loss in the switching transistors.

#### Features

- Hyperfast Recovery  $t_{rr} = 40 \text{ ns}$  (@  $I_F = 15 \text{ A}$ )
- Max Forward Voltage,  $V_F = 2.1 \text{ V}$  (@  $T_C = 25^\circ\text{C}$ )
- 400 V, 600 V Reverse Voltage and High Reliability
- Avalanche Energy Rated
- These Devices are Pb-Free and are RoHS Compliant

#### Applications

- Switching Power Supplies
- Power Switching Circuits
- General Purpose



ON Semiconductor®

[www.onsemi.com](http://www.onsemi.com)

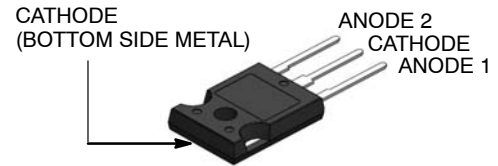

TO-247-3LD  
CASE 340CK

#### MARKING DIAGRAM

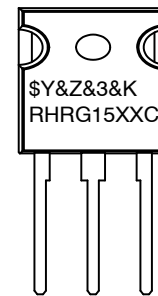

\$Y	= ON Semiconductor Logo
&Z	= Assembly Plant Code
&3	= Numeric Date Code
&K	= Lot Code
RHRG15XXC	= Specific Device Code
XX	= 60, 40

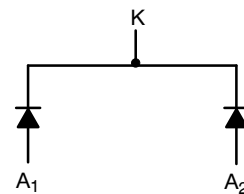

#### ORDERING INFORMATION

See detailed ordering and shipping information on page 2 of this data sheet.

# RHRG1560CC, RHRG1540CC

## ABSOLUTE MAXIMUM RATINGS (T<sub>J</sub> = 25°C, unless otherwise specified) (Per Leg)

Description	Symbol	RHRG1560CC	RHRG1540CC	Unit
Peak Repetitive Reverse Voltage	V <sub>RRM</sub>	600	400	V
Working Peak Reverse Voltage	V <sub>RWM</sub>	600	400	V
DC Blocking Voltage	V <sub>R</sub>	600	400	V
Average Rectified Forward Current (T <sub>C</sub> = 140°C)	I <sub>F(AV)</sub>	15	15	A
Repetitive Peak Surge Current (Square Wave, 20 kHz)	I <sub>FRM</sub>	30	30	A
Non-repetitive Peak Surge Current (Halfwave, 1 Phase, 60 Hz)	I <sub>FSM</sub>	200	200	A
Maximum Power Dissipation	P <sub>D</sub>	100	100	W
Avalanche Energy (See Figures 10 and 11)	E <sub>AVL</sub>	20	20	mJ
Operating and Storage Temperature	T <sub>STG, T<sub>J</sub></sub>	-65 to 175	-65 to 175	°C

Stresses exceeding those listed in the Maximum Ratings table may damage the device. If any of these limits are exceeded, device functionality should not be assumed, damage may occur and reliability may be affected.

## PACKAGE MARKING AND ORDERING INFORMATION

Part Number	Top Mark	Package	Shipping
RHRG1560CC	RHRG1560C	TO-247-3L	450 / Tube
RHRG1540CC	RHRG1540C	TO-247-3L	450 / Tube

## ELECTRICAL SPECIFICATIONS (T<sub>J</sub> = 25°C, unless otherwise specified) (Per Leg)

Characteristic	Symbol	Test Conditions	RHRG1560CC			RHRG1540CC			Unit
			Min	Typ	Max	Min	Typ	Max	Unit
Instantaneous Forward Voltage (Pulse Width = 300 μs, Duty Cycle = 2%)	V <sub>F</sub>	I <sub>F</sub> = 15 A	-	-	2.1	-	-	2.1	V
		I <sub>F</sub> = 15 A, T <sub>C</sub> = 150°C	-	-	1.7	-	-	1.7	V
Instantaneous Reverse Current	I <sub>R</sub>	V <sub>R</sub> = 400 V	-	-	-	-	-	100	μA
		V <sub>R</sub> = 600 V	-	-	100	-	-	-	μA
		V <sub>R</sub> = 400 V, T <sub>C</sub> = 150°C	-	-	-	-	-	500	μA
		V <sub>R</sub> = 600 V, T <sub>C</sub> = 150°C	-	-	500	-	-	-	μA
Reverse Recovery Time (See Figure 9), Summation of t <sub>a</sub> + t <sub>b</sub> .	T <sub>rr</sub>	I <sub>F</sub> = 1 A, dI <sub>F</sub> /dt = 100 A/μs	-	-	35	-	-	35	ns
		I <sub>F</sub> = 15 A, dI <sub>F</sub> /dt = 100 A/μs	-	-	40	-	-	40	ns
Time to Reach Peak Reverse Current (See Figure 9).	t <sub>a</sub>	I <sub>F</sub> = 15 A, dI <sub>F</sub> /dt = 100 A/μs	-	20	-	-	20	-	ns
Time from Peak I <sub>RM</sub> to Projected Zero Crossing of I <sub>RM</sub> Based on a Straight Line from Peak I <sub>RM</sub> through 25% of I <sub>RM</sub> (See Figure 9).	t <sub>b</sub>	I <sub>F</sub> = 15 A, dI <sub>F</sub> /dt = 100 A/μs	-	15	-	-	15	-	ns
Reverse Recovery Charge	Q <sub>rr</sub>	I <sub>F</sub> = 15 A, dI <sub>F</sub> /dt = 100 A/μs	-	40	-	-	40	-	nC
Junction Capacitance	C <sub>J</sub>	V <sub>R</sub> = 10 V, I <sub>F</sub> = 0 A	-	60	-	-	60	-	pF
Thermal Resistance Junction to Case	R <sub>θJC</sub>		-	-	1.5	-	-	1.5	°C/W

Product parametric performance is indicated in the Electrical Characteristics for the listed test conditions, unless otherwise noted. Product performance may not be indicated by the Electrical Characteristics if operated under different conditions.

# RHRG1560CC, RHRG1540CC

## TYPICAL PERFORMANCE CURVES

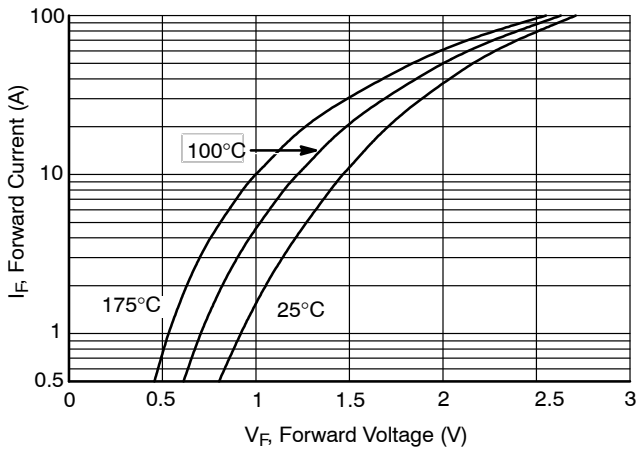

**Figure 1. Forward Current vs. Forward Voltage**

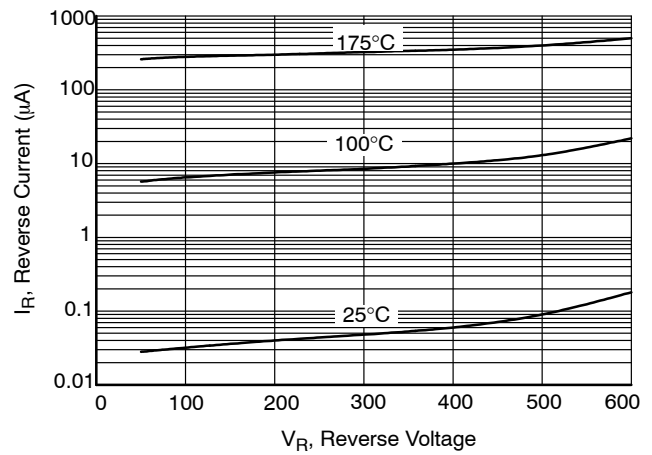

**Figure 2. Reverse Current vs. Reverse Voltage**

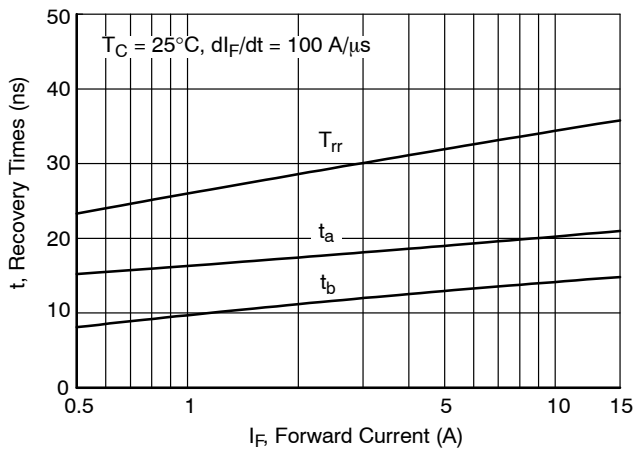

**Figure 3.  $T_{rr}$ ,  $t_a$  and  $t_b$  Curves vs. Forward Current**

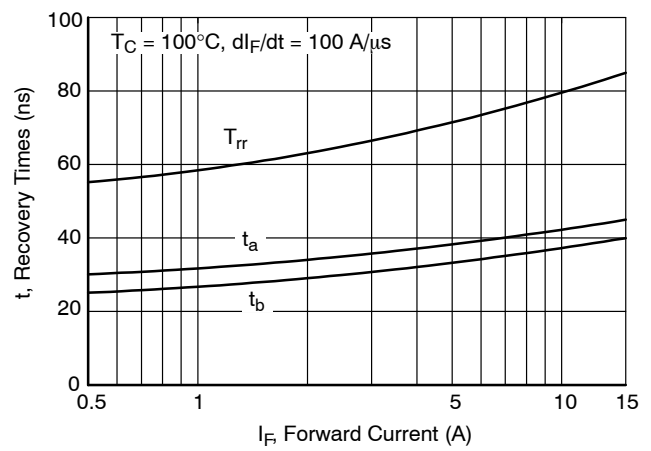

**Figure 4.  $T_{rr}$ ,  $t_a$  and  $t_b$  Curves vs. Forward Current**

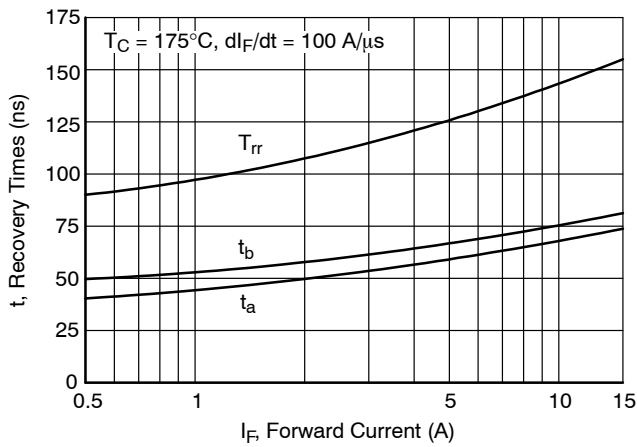

**Figure 5.  $T_{rr}$ ,  $t_a$  and  $t_b$  Curves vs. Forward Current**

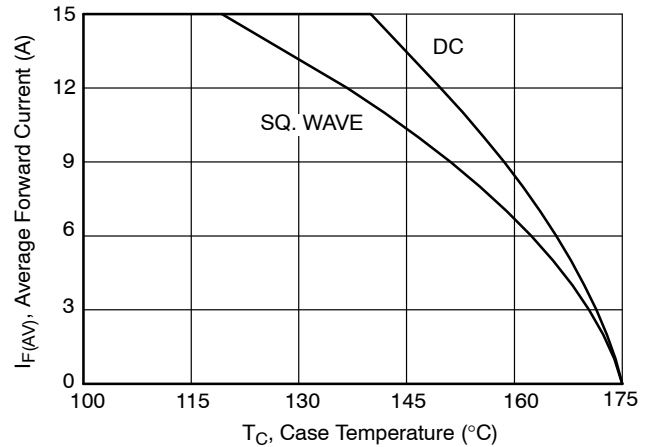

**Figure 6. Current Derating Curve**

TYPICAL PERFORMANCE CHARACTERISTICS (continued)

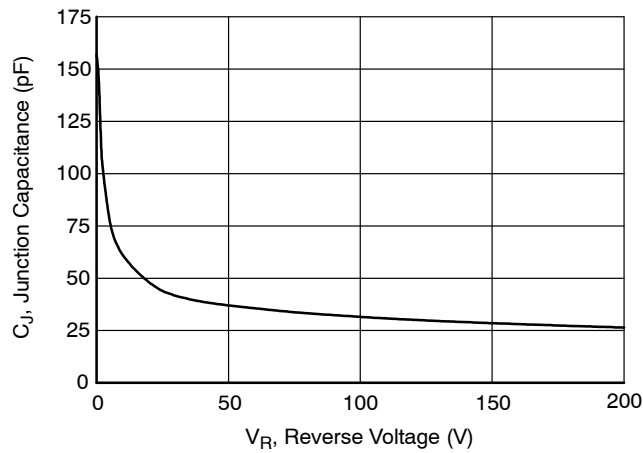

Figure 7. Junction Capacitance vs. Reverse Voltage

TEST CIRCUITS AND WAVEFORMS

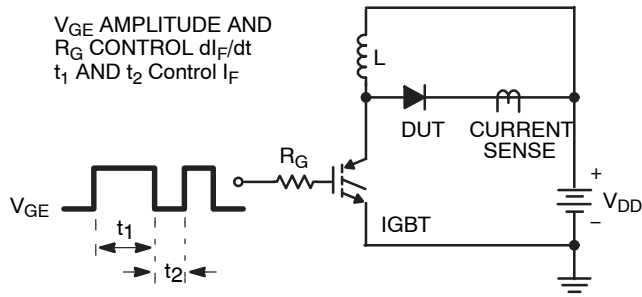

Figure 8.  $T_{rr}$  Test Circuit

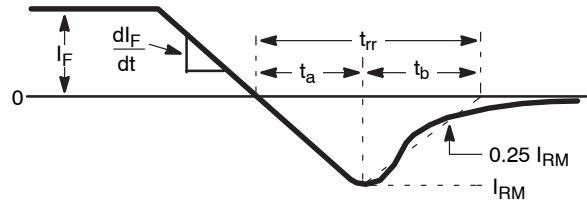

Figure 9.  $T_{rr}$  Waveforms and Definitions

$I_{MAX} = 1 A$   
 $L = 40 mH$   
 $R < 0.1 \Omega$   
 $E_{AVL} = 1/2LI^2 [V_{R(AVL)}/(V_{R(AVL)} - V_{DD})]$   
 $Q_1 = IGBT (BV_{CES} > DUT V_{R(AVL)})$

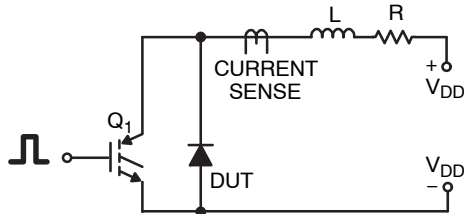

Figure 10. Avalanche Energy Test Circuit

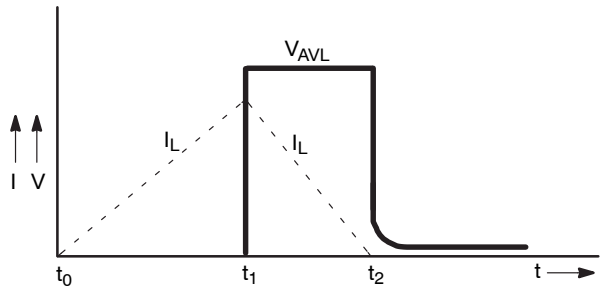
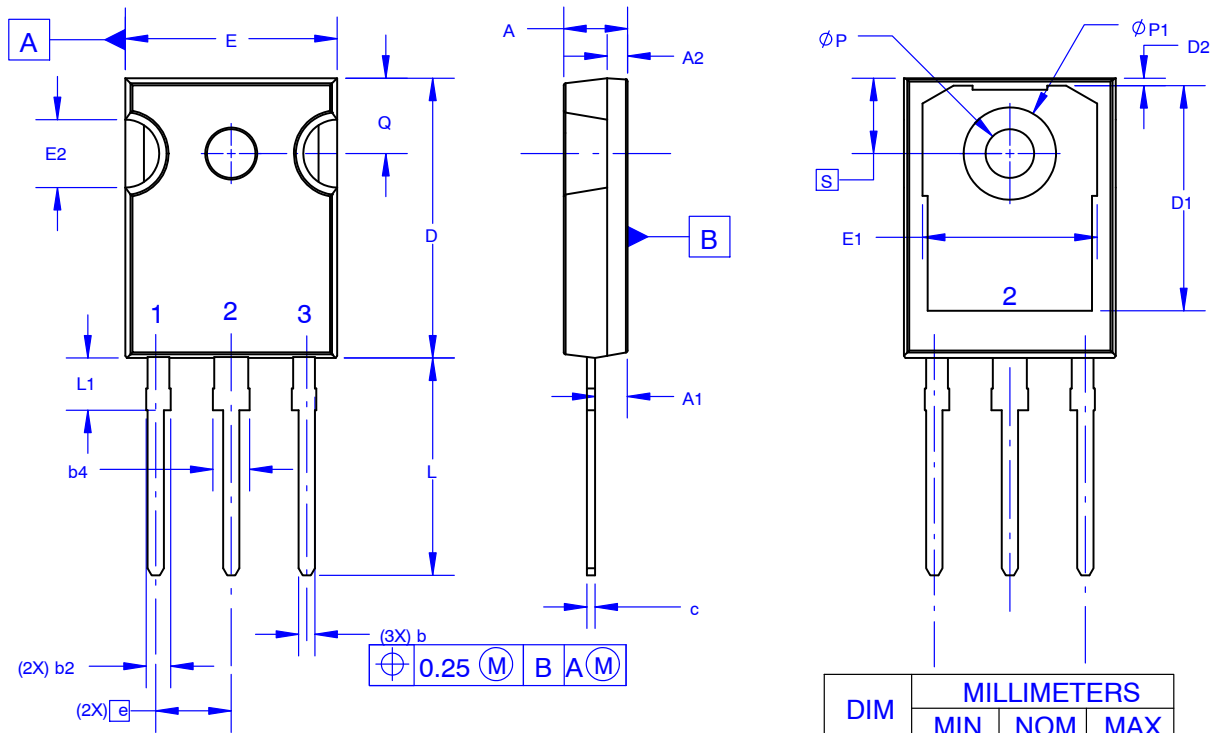

Figure 11. Avalanche Current and Voltage Waveforms

**TO-247-3LD SHORT LEAD**  
**CASE 340CK**  
**ISSUE A**

DATE 31 JAN 2019



NOTES: UNLESS OTHERWISE SPECIFIED.

- A. DIMENSIONS ARE EXCLUSIVE OF BURRS, MOLD FLASH, AND TIE BAR EXTRUSIONS.
- B. ALL DIMENSIONS ARE IN MILLIMETERS.
- C. DRAWING CONFORMS TO ASME Y14.5 - 2009.
- D. DIMENSION A1 TO BE MEASURED IN THE REGION DEFINED BY L1.
- E. LEAD FINISH IS UNCONTROLLED IN THE REGION DEFINED BY L1.

**GENERIC MARKING DIAGRAM\***

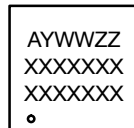

XXXX = Specific Device Code  
A = Assembly Location  
Y = Year  
WW = Work Week  
ZZ = Assembly Lot Code

\*This information is generic. Please refer to device data sheet for actual part marking. Pb-Free indicator, "G" or microdot "◦", may or may not be present. Some products may not follow the Generic Marking.

DIM	MILLIMETERS		
	MIN	NOM	MAX
A	4.58	4.70	4.82
A1	2.20	2.40	2.60
A2	1.40	1.50	1.60
b	1.17	1.26	1.35
b2	1.53	1.65	1.77
b4	2.42	2.54	2.66
c	0.51	0.61	0.71
D	20.32	20.57	20.82
D1	13.08	~	~
D2	0.51	0.93	1.35
E	15.37	15.62	15.87
E1	12.81	~	~
E2	4.96	5.08	5.20
e	~	5.56	~
L	15.75	16.00	16.25
L1	3.69	3.81	3.93
$\phi P$	3.51	3.58	3.65
$\phi P1$	6.60	6.80	7.00
Q	5.34	5.46	5.58
S	5.34	5.46	5.58

<b>DOCUMENT NUMBER:</b>	<b>98AON13851G</b>	Electronic versions are uncontrolled except when accessed directly from the Document Repository. Printed versions are uncontrolled except when stamped "CONTROLLED COPY" in red.
<b>DESCRIPTION:</b>	<b>TO-247-3LD SHORT LEAD</b>	<b>PAGE 1 OF 1</b>

ON Semiconductor and are trademarks of Semiconductor Components Industries, LLC dba ON Semiconductor or its subsidiaries in the United States and/or other countries. ON Semiconductor reserves the right to make changes without further notice to any products herein. ON Semiconductor makes no warranty, representation or guarantee regarding the suitability of its products for any particular purpose, nor does ON Semiconductor assume any liability arising out of the application or use of any product or circuit, and specifically disclaims any and all liability, including without limitation special, consequential or incidental damages. ON Semiconductor does not convey any license under its patent rights nor the rights of others.

ON Semiconductor and  are trademarks of Semiconductor Components Industries, LLC dba ON Semiconductor or its subsidiaries in the United States and/or other countries. ON Semiconductor owns the rights to a number of patents, trademarks, copyrights, trade secrets, and other intellectual property. A listing of ON Semiconductor's product/patent coverage may be accessed at [www.onsemi.com/site/pdf/Patent-Marking.pdf](http://www.onsemi.com/site/pdf/Patent-Marking.pdf). ON Semiconductor reserves the right to make changes without further notice to any products herein. ON Semiconductor makes no warranty, representation or guarantee regarding the suitability of its products for any particular purpose, nor does ON Semiconductor assume any liability arising out of the application or use of any product or circuit, and specifically disclaims any and all liability, including without limitation special, consequential or incidental damages. Buyer is responsible for its products and applications using ON Semiconductor products, including compliance with all laws, regulations and safety requirements or standards, regardless of any support or applications information provided by ON Semiconductor. "Typical" parameters which may be provided in ON Semiconductor data sheets and/or specifications can and do vary in different applications and actual performance may vary over time. All operating parameters, including "Typicals" must be validated for each customer application by customer's technical experts. ON Semiconductor does not convey any license under its patent rights nor the rights of others. ON Semiconductor products are not designed, intended, or authorized for use as a critical component in life support systems or any FDA Class 3 medical devices or medical devices with a same or similar classification in a foreign jurisdiction or any devices intended for implantation in the human body. Should Buyer purchase or use ON Semiconductor products for any such unintended or unauthorized application, Buyer shall indemnify and hold ON Semiconductor and its officers, employees, subsidiaries, affiliates, and distributors harmless against all claims, costs, damages, and expenses, and reasonable attorney fees arising out of, directly or indirectly, any claim of personal injury or death associated with such unintended or unauthorized use, even if such claim alleges that ON Semiconductor was negligent regarding the design or manufacture of the part. ON Semiconductor is an Equal Opportunity/Affirmative Action Employer. This literature is subject to all applicable copyright laws and is not for resale in any manner.

## PUBLICATION ORDERING INFORMATION

### LITERATURE FULFILLMENT:

Email Requests to: [orderlit@onsemi.com](mailto:orderlit@onsemi.com)

ON Semiconductor Website: [www.onsemi.com](http://www.onsemi.com)

### TECHNICAL SUPPORT

North American Technical Support:  
Voice Mail: 1 800-282-9855 Toll Free USA/Canada  
Phone: 011 421 33 790 2910

Europe, Middle East and Africa Technical Support:

Phone: 00421 33 790 2910

For additional information, please contact your local Sales Representative

# Mouser Electronics

Authorized Distributor

Click to View Pricing, Inventory, Delivery & Lifecycle Information:

[ON Semiconductor:](#)

[RHRG1560CC](#)