

Click [here](#) for production status of specific part numbers.

## MAX40056F/MAX40056T/ MAX40056U

### General Description

The MAX40056 is a bidirectional current-sense amplifier with an input common-mode range that extends from -0.1V to +65V together with protection against negative inductive kickback voltages to -5V. This CSA is well-suited for phase current monitoring of inductive loads, such as motors and solenoids, where pulse width modulation is used to control the drive voltage and current. The MAX40056 uses an improved technique to help reject common-mode input PWM edges with slew rates up to and beyond  $\pm 500\text{V}/\mu\text{s}$ . Common mode rejection ratio (CMRR) is typically 60dB (50V,  $\pm 500\text{V}/\mu\text{s}$  input) and 140dB DC, typical.

The MAX40056 has an internal +1.5V reference for use with a nominal +3.3V power supply. The reference can also be used to drive an adjoining differential ADC. The reference is used to offset the output to indicate the direction of the input sensed current. The REF pin can source current into external loads and helps to avoid the performance compromises resulting from routing reference voltages across noisy PCBs. Alternatively, for higher supply voltages and higher full-scale output swings, the internal reference can be overridden by a higher voltage, external reference.

The internal or external reference can be used to define the trip threshold for the integrated overcurrent comparator. This can provide immediate indication of an overcurrent fault condition.

The MAX40056 operates over the full  $-40^{\circ}\text{C}$  to  $+125^{\circ}\text{C}$  temperature range and runs from a supply voltage of +2.7V to +5.5V. It is offered in a 2.02mm x 1.4mm 8-pin wafer-level package (WLP) and 8-pin  $\mu\text{MAX}$  packages.

### Applications

- PWM H-Bridge Motor In-line/In-phase/Winding Current Sensing
- Solenoid Current Sensing
- Current Monitoring of Inductive Loads
- Battery Stack Monitors
- Automotive

## Bidirectional Current Sense Amplifier with PWM-Rejection

### Benefits and Features

- Fast, 500ns PWM Edge Recovery from  $500\text{V}/\mu\text{s}$  PWM Edges
- 60dB AC CMRR Rejection at 50V,  $\pm 500\text{V}/\mu\text{s}$  PWM Edges
- 140dB DC CMRR Rejection
- -0.1V to +65V Input Voltage Range
- -5V to +70V Protective Immunity
- 300kHz, -3dB Bandwidth
- Multiple Gain Options; 10V/V, 20V/V, 50V/V
- Internal, 1% Reference for Bidirectional Offset
- 5 $\mu\text{V}$  (Typ) Input Offset Voltage
- Rail-to-Rail Output
- 2.02mm x 1.4mm WLP-8 and 8-pin  $\mu\text{MAX}$
- $-40^{\circ}\text{C}$  to  $+125^{\circ}\text{C}$  Temperature Range

[Ordering Information](#) appears at end of data sheet.

### Typical Operating Characteristic and Simplified Block Diagram

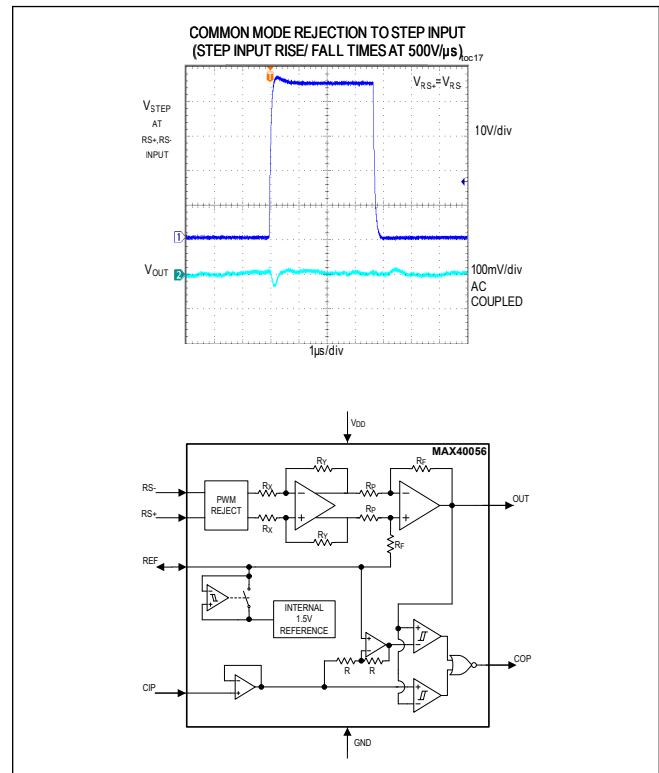

### Absolute Maximum Ratings

RS+ and RS- to GND .....	-5V to +70V	Continuous Current in RS+ and RS-.....	10mA
RS+ to RS- .....	±2V	Continuous Power Dissipation (Multi Layer Board) (T <sub>A</sub> = +70°C, derate 4.8mW/°C above +70°C) .....	390mW
V <sub>DD</sub> to GND.....	-0.3V to +6V	Operating Temperature Range .....	-40°C to +125°C
REF, CIP, OUT, COP To GND.....	-0.3V to V <sub>DD</sub> + 0.3V	Storage Temperature Range .....	-65°C to +150°C
Continuous Current in REF, CIP .....	5mA		
Continuous Current in OUT and COP .....	10mA		

Stresses beyond those listed under "Absolute Maximum Ratings" may cause permanent damage to the device. These are stress ratings only, and functional operation of the device at these or any other conditions beyond those indicated in the operational sections of the specifications is not implied. Exposure to absolute maximum rating conditions for extended periods may affect device reliability.

### Package Information

#### 8 μMAX

Package Code	U8+4
Outline Number	<a href="#">21-0036</a>
Land Pattern Number	<a href="#">90-0092</a>
<b>Thermal Resistance, Four-Layer Board:</b>	
Junction-to-Ambient (θ <sub>JA</sub> )	206°C/W
Junction-to-Case Thermal Resistance (θ <sub>JC</sub> )	42°C/W

#### 8 WLP

Package Code	W81B2+1
Outline Number	<a href="#">21-100255</a>
Land Pattern Number	Refer to <a href="#">Application Note 1891</a>
<b>Thermal Resistance, Four-Layer Board:</b>	
Junction-to-Ambient (θ <sub>JA</sub> )	74.65°C/W

For the latest package outline information and land patterns (footprints), go to [www.maximintegrated.com/packages](http://www.maximintegrated.com/packages). Note that a "+", "#", or "-" in the package code indicates RoHS status only. Package drawings may show a different suffix character, but the drawing pertains to the package regardless of RoHS status.

Package thermal resistances were obtained using the method described in JEDEC specification JESD51-7, using a four-layer board. For detailed information on package thermal considerations, refer to [www.maximintegrated.com/thermal-tutorial](http://www.maximintegrated.com/thermal-tutorial).

### Electrical Characteristics

( $V_{DD} = 3.3V$ ,  $V_{CM} = 48V$ ,  $V_{SENSE} = 20mV$ , OUT loading = 10k $\Omega$  and 20pF to GND, COP loading = 5k $\Omega$  and 10pF to GND,  $T_{MIN} = -40^{\circ}C$ ,  $T_{MAX} = 125^{\circ}C$ , (Note 1))

PARAMETER	SYMBOL	CONDITIONS	MIN	TYP	MAX	UNITS
<b>POWER SUPPLY CHARACTERISTICS</b>						
Supply Voltage	$V_{DD}$	Guaranteed by PSRR	2.7		5.5	V
Supply Current	$I_{DD}$			6	9	mA
Power-Up Time	$t_{PWR\_UP}$	Out settle within 1%		400		$\mu s$
<b>CURRENT SENSE AMPLIFIER / DC CHARACTERISTICS</b>						
Input Protected CM Range	$V_{CM\_P}$		-5		+70	V
Input Common Mode Range	$V_{CM}$	$-40^{\circ}C \leq T_A \leq +85^{\circ}C$	-0.3		+65	V
		$-40^{\circ}C \leq T_A \leq +125^{\circ}C$	-0.1		+65	
Input Bias Current	$I_{RS+}, I_{RS-}$	$V_{SENSE} = 0V$ (Note 2)		3	200	nA
		$V_{SENSE} = 20mV$		20	30	$\mu A$
Input Leakage Current	$I_{LKG}$	$V_{DD} = 0V, 0V \leq V_{RS\pm} \leq 65V$ (Note 2)		3	200	nA
Input Offset Voltage	$V_{OS}$	$T_A = +25^{\circ}C$		5	20	$\mu V$
		$-40^{\circ}C \leq T_A \leq +125^{\circ}C$			300	
Input Offset Drift	$TCV_{OS}$			0.5		$\mu V/^{\circ}C$
Power Supply Rejection Ratio	PSRR	$2.7V \leq V_{DD} \leq 5.5V$	90	110		dB
Common Mode Rejection Ratio	CMRR	$-0.3V \leq V_{CM} \leq +65V; -40^{\circ}C \leq T_A \leq +85^{\circ}C$	100	140		
		$-0.1V \leq V_{CM} \leq +65V; -40^{\circ}C \leq T_A \leq +125^{\circ}C$	120	140		
Input Capacitance	$C_{IN}$	RS+ and RS- input		3		pF
Nominal Gain	$G_U$	MAX40056U		10		V/V
	$G_T$	MAX40056T		20		
	$G_F$	MAX40056F		50		
Gain Error	$GE_F$	$V_{CM} = -0.3V, -40^{\circ}C \leq T_A \leq +85^{\circ}C, -16mV \leq V_{SENSE} \leq +16mV, MAX40056F$		0.05	1.5	%
		$V_{CM} = 48V, -40^{\circ}C \leq T_A \leq +125^{\circ}C, -16mV \leq V_{SENSE} \leq +16mV, MAX40056F$		0.05	0.5	
Output Voltage Swing High	$V_{OH}$	Sourcing 5mA; $V_{OH} = V_{DD} - V_{OUT}$		45	100	mV
Output Voltage Swing Low	$V_{OL}$	Sinking 5mA; $V_{OL} = V_{OUT} - GND$		35	70	mV
Output Short-Circuit Current	$I_{SC}$	Shorted to either $V_{DD}$ or GND		20		mA
<b>CURRENT SENSE AMPLIFIER / AC CHARACTERISTICS</b>						
Signal Bandwidth	$BW_{-3dB}$	50% of full-scale range		300		kHz
Output Slew Rate	SR	$2V_{PP}$ output square wave, centered at 1.5V		1.5		V/ $\mu s$
Amplifier Small-Signal Settling Time (1%)	$t_s$	$\pm 200mV$ output step		2.5		$\mu s$

### Electrical Characteristics (continued)

( $V_{DD} = 3.3V$ ,  $V_{CM} = 48V$ ,  $V_{SENSE} = 20mV$ , OUT loading = 10k $\Omega$  and 20pF to GND, COP loading = 5k $\Omega$  and 10pF to GND,  $T_{MIN} = -40^{\circ}C$ ,  $T_{MAX} = 125^{\circ}C$ , (Note 1))

PARAMETER	SYMBOL	CONDITIONS	MIN	TYP	MAX	UNITS
PWM Edge Recovery Settling Time	$t_{S\_PWM}$	0V to 50V edges: 500V/ $\mu s$ rise/fall times, $V_{SENSE} = 0mV$ ( $V_{RS+} = V_{RS-}$ )		500		ns
AC Common Mode Rejection Ratio	AC CMRR	100mV <sub>AC</sub> Sine, f = 100kHz		70		dB
AC Power Supply Rejection Ratio	AC PSRR	100mV <sub>AC</sub> Sine, f = 100kHz		53		dB
Voltage Noise Density	$e_n$	At 10kHz		150		nV/ $\sqrt{Hz}$
<b>INTERNAL REFERENCE</b>						
REF Output Voltage	$V_{REF}$	No load; $-40^{\circ}C \leq T_A \leq +125^{\circ}C$	1.485	1.5	1.515	V
REF Thermal Drift	$TCV_{REF}$			30		ppm/ $^{\circ}C$
REF Load Regulation	$\Delta V_{REF}/\Delta I_{REF}$	$0\mu A \leq$ external load $\leq 500\mu A$		30	70	$\mu V/\mu A$
REF Line Regulation	$\Delta V_{REF}/\Delta V_{DD}$	$2.7V \leq V_{DD} \leq 5.5V$		0.1	0.5	mV/V
REF Cap Loading		No sustained oscillation		1		$\mu F$
Internal\External Reference Switching Threshold Voltage	$V_{REF\_TH}$	External reference is enabled by overdriving		1.65	1.75	V
<b>INTERNAL COMPARATOR</b>						
CIP Input Resistance	$R_{CIP}$	Resistance appears to be to $V_{REF}$		10		G $\Omega$
CIP Input Common Mode Range	$V_{CIP\_IN}$		0.08		MIN ( $V_{REF} - 0.08$ , $V_{DD} - 1.25$ )	V
Input Offset Voltage	$V_{OS\_CMP}$	$80mV \leq V_{CIP} \leq$ min ( $V_{REF} - 80mV$ , $V_{DD} - 1.25V$ )		10		mV
Hysteresis	$V_{HYS}$	$80mV \leq V_{CIP} \leq$ min ( $V_{REF} - 80mV$ , $V_{DD} - 1.25V$ )		40		mV
COP Output Voltage Swing High	$V_{OH\_CMP}$	Sourcing 2mA; $V_{OH\_CMP} = V_{DD} - V_{COP}$		0.12	0.3	V
COP Output Voltage Swing Low	$V_{OL\_CMP}$	Sinking 4mA; $V_{OL\_CMP} = V_{COP} - GND$		0.12	0.3	V
Propagation Delay	$t_{PDL \rightarrow H}$	200mV overdrive, low-to-high		14		$\mu s$
	$t_{PDH \rightarrow L}$	200mV overdrive, high-to-low		12		

**Note 1:** Limits are 100% tested at  $T_A = +25^{\circ}C$ . Limits over the operating temperature range and relevant supply voltage range are guaranteed by design and characterization.

**Note 2:** Guaranteed by design and bench characterization.

### Typical Operating Characteristics

( $V_{DD} = 3.3V$ ,  $V_{SENSE} = 20mV$ ,  $V_{CM} = 48V$ , OUT LOAD = 10k $\Omega$  and 20pF to GND, COP LOAD = 5k $\Omega$  and 10pF to GND,  $T_A = +25^\circ C$ , unless otherwise noted.)

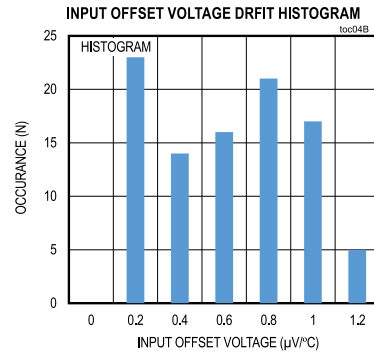
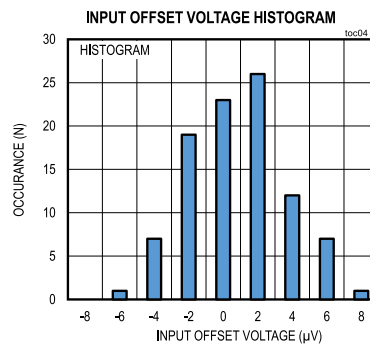
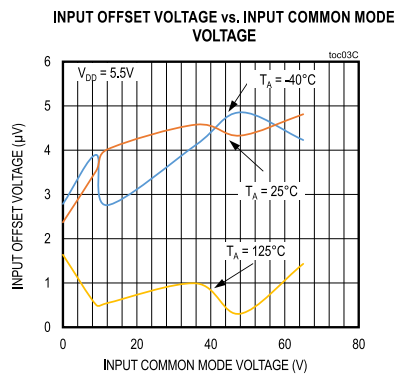
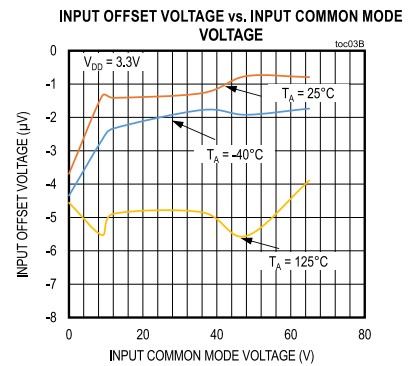
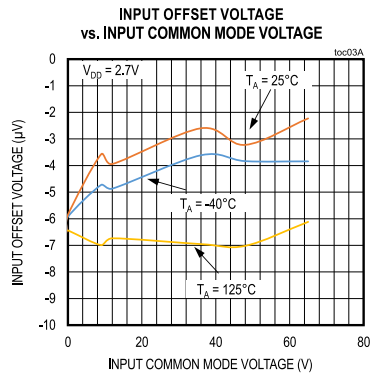
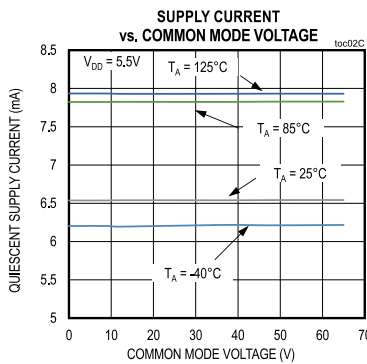
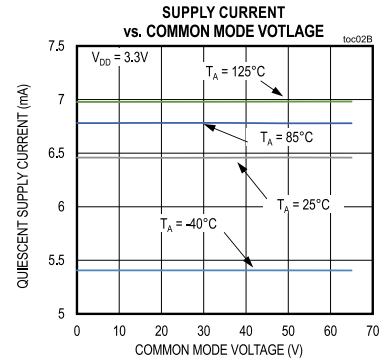
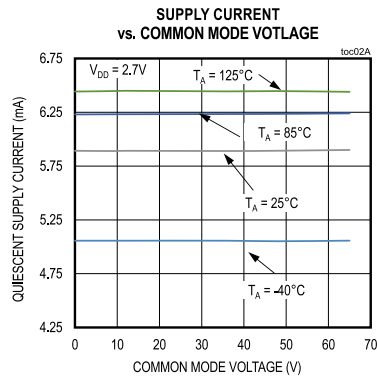
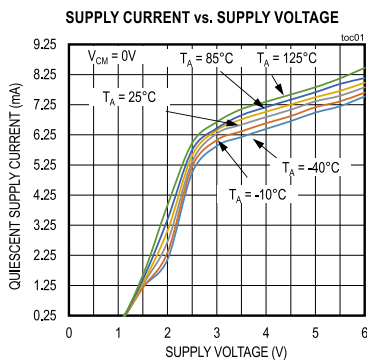

Typical Operating Characteristics (continued)

( $V_{DD} = 3.3V$ ,  $V_{SENSE} = 20mV$ ,  $V_{CM} = 48V$ , OUT LOAD = 10k $\Omega$  and 20pF to GND, COP LOAD = 5k $\Omega$  and 10pF to GND,  $T_A = +25^\circ C$ , unless otherwise noted.)

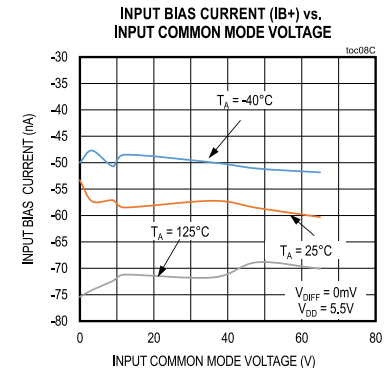
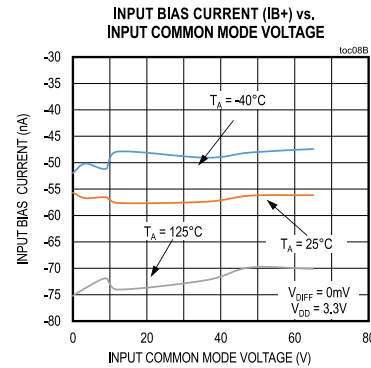
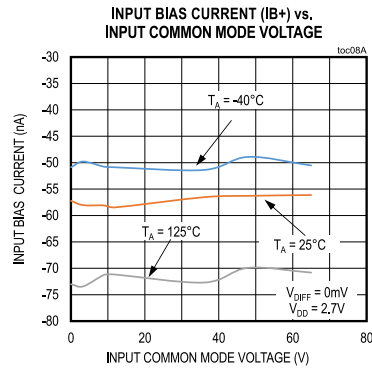
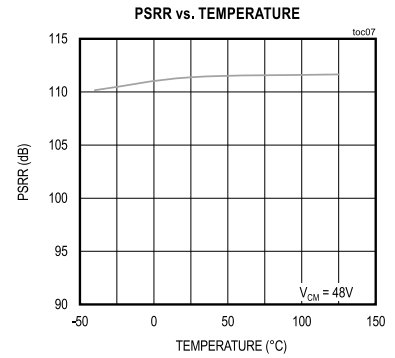
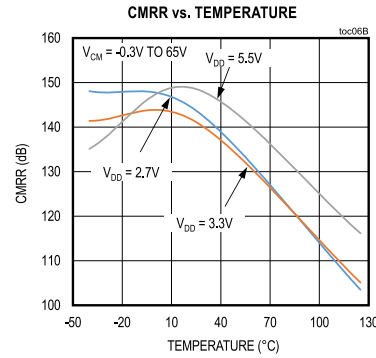
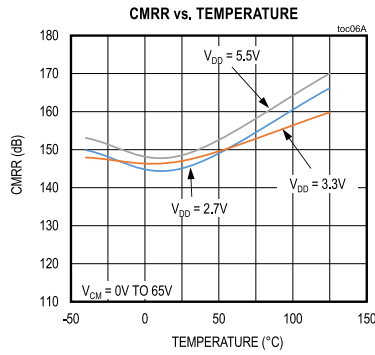
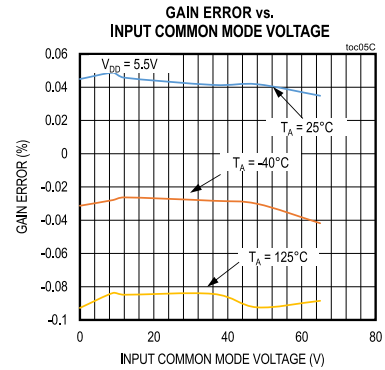
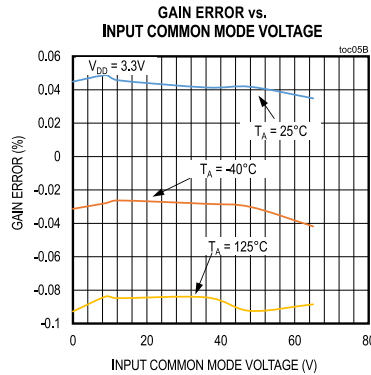
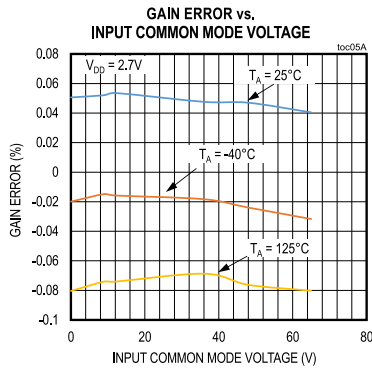

Typical Operating Characteristics (continued)

( $V_{DD} = 3.3V$ ,  $V_{SENSE} = 20mV$ ,  $V_{CM} = 48V$ , OUT LOAD =  $10k\Omega$  and  $20pF$  to GND, COP LOAD =  $5k\Omega$  and  $10pF$  to GND,  $T_A = +25^\circ C$ , unless otherwise noted.)

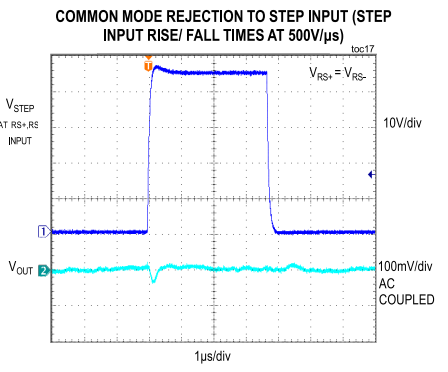
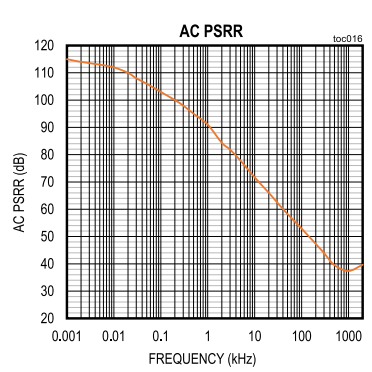
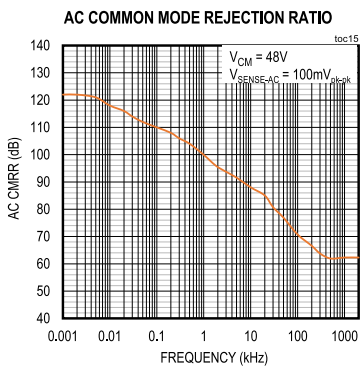
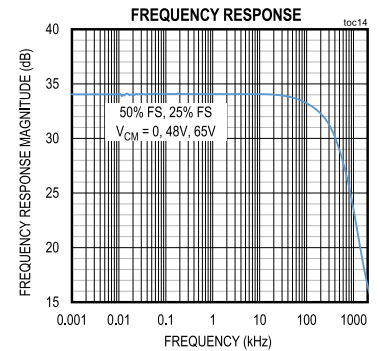
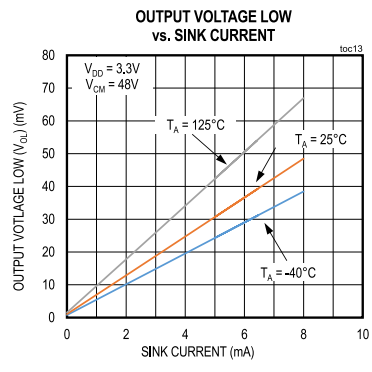
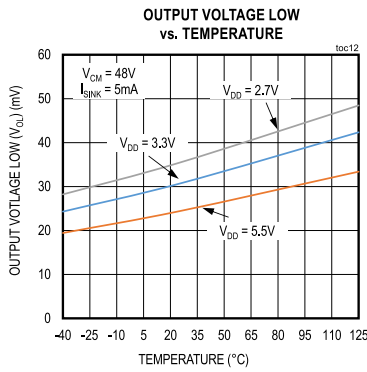
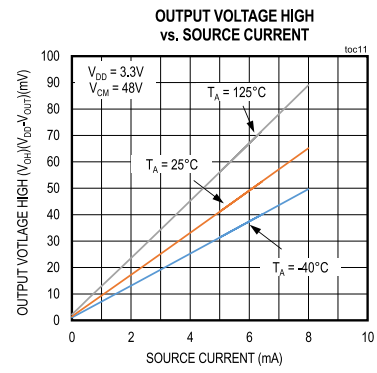
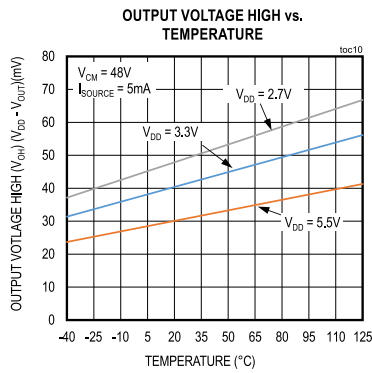
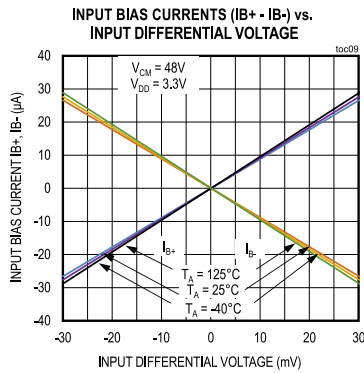

Typical Operating Characteristics (continued)

( $V_{DD} = 3.3V$ ,  $V_{SENSE} = 20mV$ ,  $V_{CM} = 48V$ , OUT LOAD =  $10k\Omega$  and  $20pF$  to GND, COP LOAD =  $5k\Omega$  and  $10pF$  to GND,  $T_A = +25^\circ C$ , unless otherwise noted.)

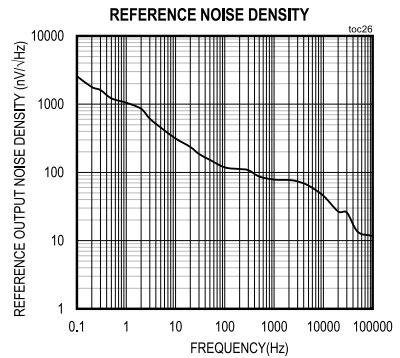
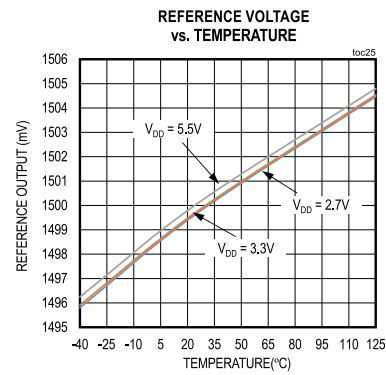
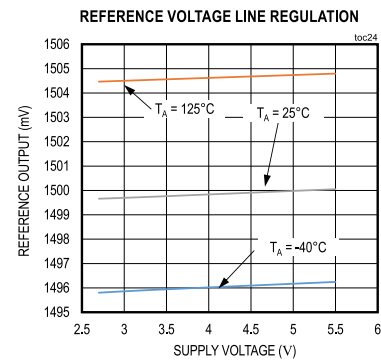
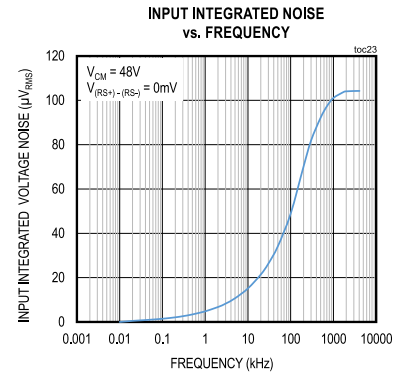
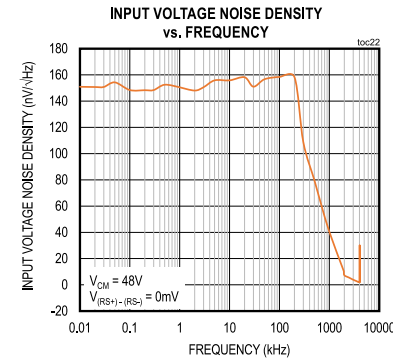
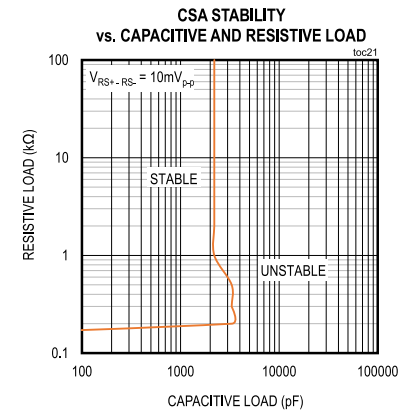
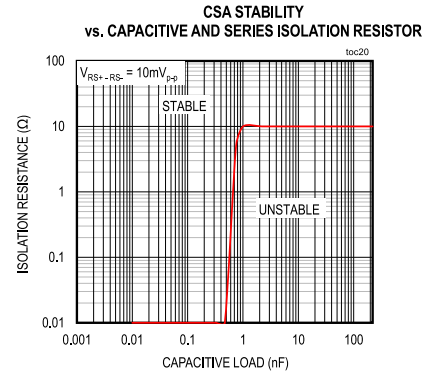
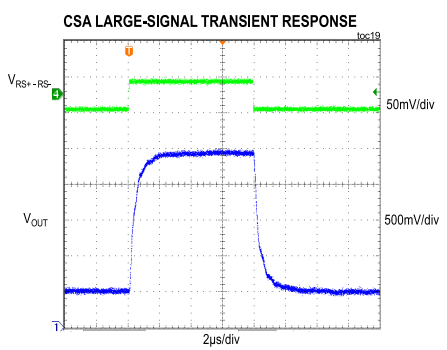
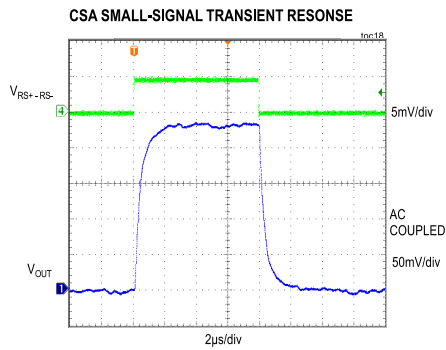



Typical Operating Characteristics (continued)

( $V_{DD} = 3.3V$ ,  $V_{SENSE} = 20mV$ ,  $V_{CM} = 48V$ , OUT LOAD =  $10k\Omega$  and  $20pF$  to GND, COP LOAD =  $5k\Omega$  and  $10pF$  to GND,  $T_A = +25^\circ C$ , unless otherwise noted.)

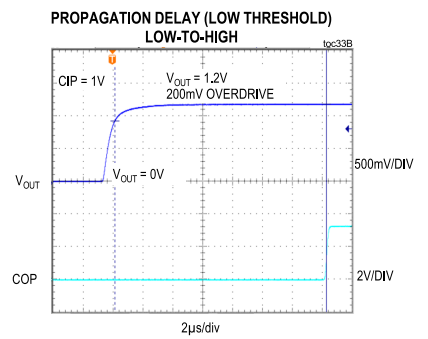
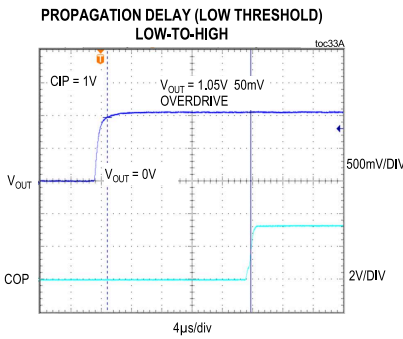
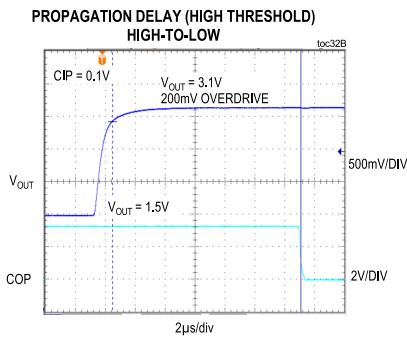
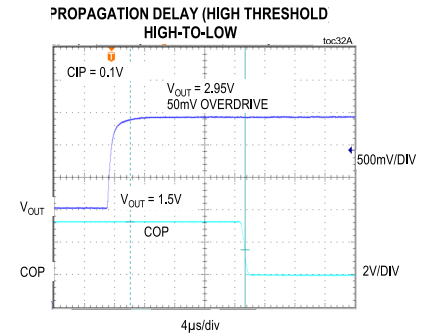
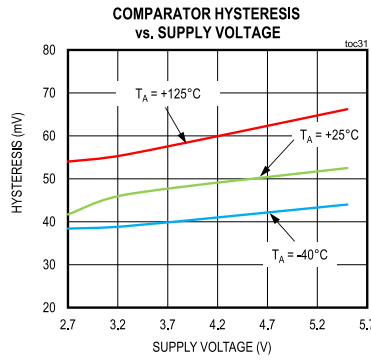
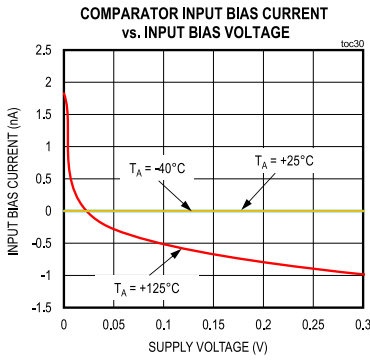
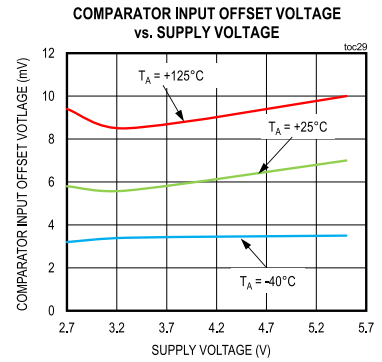
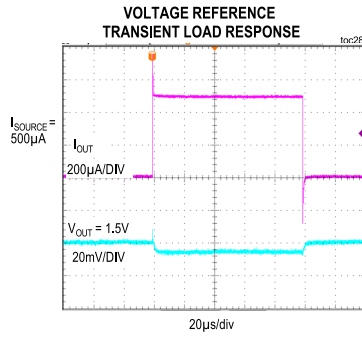
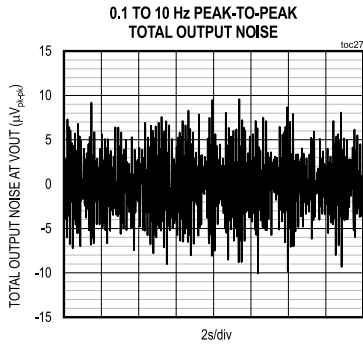

Typical Operating Characteristics (continued)

( $V_{DD} = 3.3V$ ,  $V_{SENSE} = 20mV$ ,  $V_{CM} = 48V$ , OUT LOAD =  $10k\Omega$  and  $20pF$  to GND, COP LOAD =  $5k\Omega$  and  $10pF$  to GND,  $T_A = +25^\circ C$ , unless otherwise noted.)

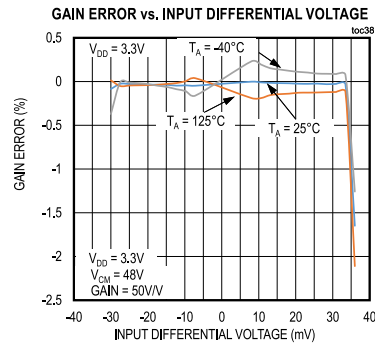
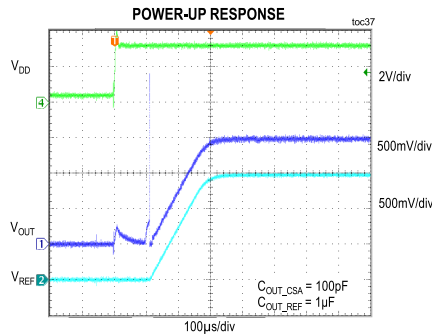
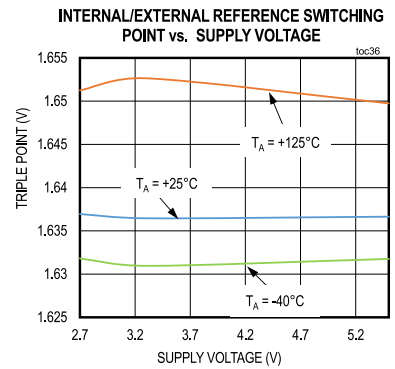
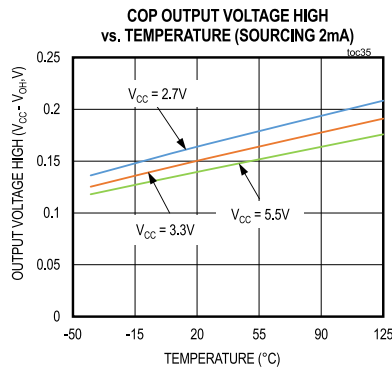
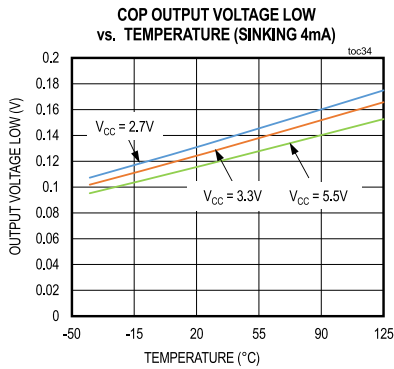

### Pin Configuration

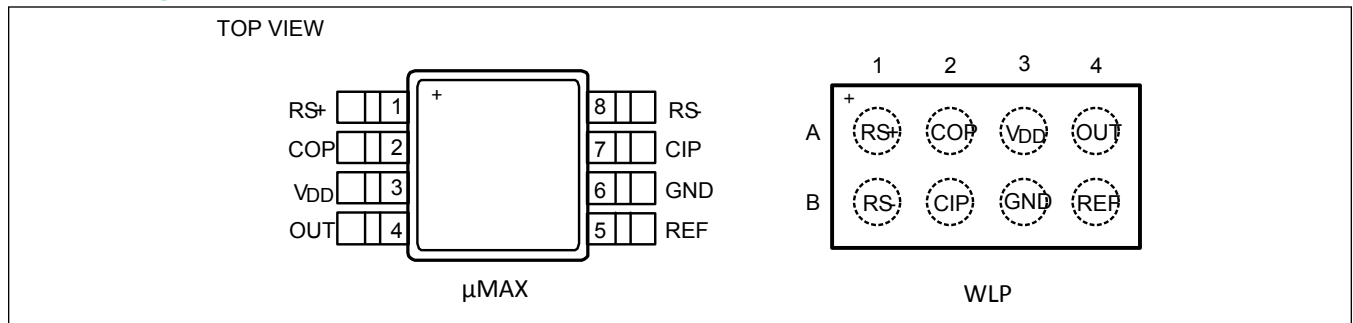

### Pin Description

PIN	NAME	FUNCTION
1	RS+	External Resistor Power-Side Connection Input
2	COP	Active-Low Comparator Push-Pull Output. Output low indicates fault condition.
3	V <sub>DD</sub>	Supply Voltage Input. +2.7V to +5.5V. Bypass to ground with a 10nF COG\NPO and 1μF X5R.
4	OUT	Current-Sense Output. Output has its common mode point at V <sub>REF</sub> .
8	RS-	External Resistor Load-Side Connection Input
7	CIP	Comparator Input/Overcurrent Threshold Input
6	GND	Ground. Signal and power return.
5	REF	Internal 1.5V Reference Output. Intended to be used with OUT to indicate the current's direction. Bypass to GND with a 10nF and a 1μF capacitors.  Connect external reference greater than 1.5V to override internal reference and change output common mode voltage.

## Detailed Description

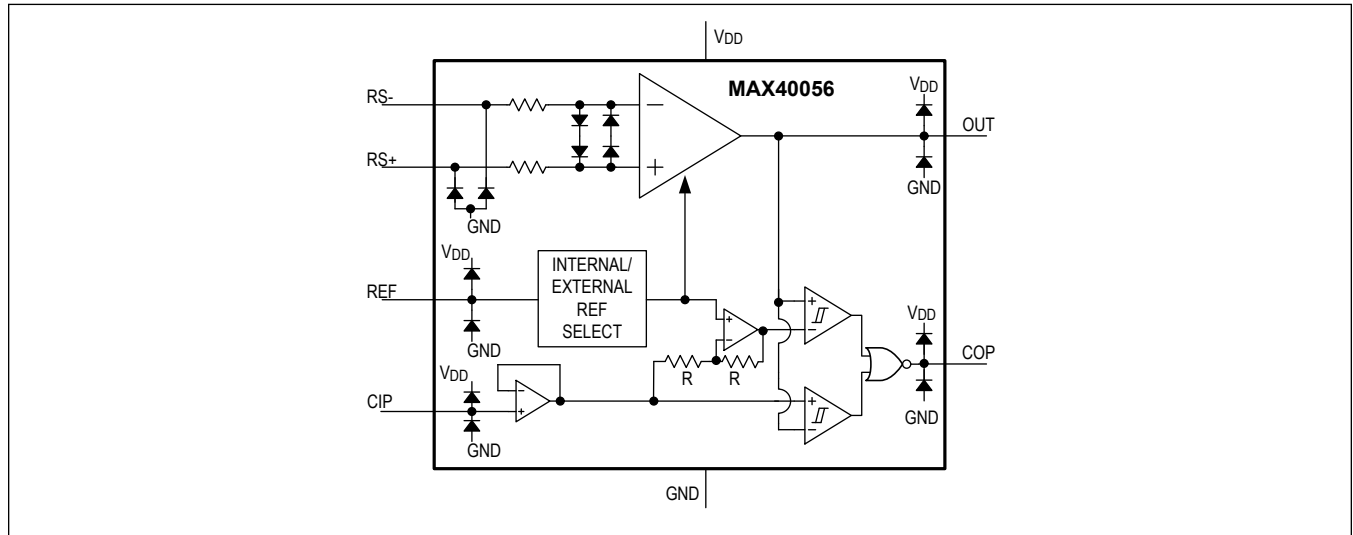

Figure 1. Internal ESD Clamping Structure

### Overview

The MAX40056 is a single-supply, high-accuracy, bidirectional current sense amplifier with a high common-mode input range extending from -0.1V to +65V. The input stage provides protection against voltage spikes and inductive kickbacks from -5V up to +70V. The  $\pm 5\mu\text{V}$  (typ) input offset voltage and 0.05% (typ) gain error help to ensure low system errors.

The input stage is specifically designed to suppress the disturbance of fast PWM signals, which are common in motor control applications. The MAX40056 is, therefore, well-suited for in-phase current monitoring of inductive loads, such as motor windings and solenoids that are driven by PWM signals. The MAX40056 operates over the full  $-40^\circ\text{C}$  to  $+125^\circ\text{C}$  temperature range and from a supply voltage of +2.7V to +5.5V.

[Figure 1](#) shows the internal clamping/protection structure.

### PWM Rejection Input Stage

The proprietary input architecture is immune to the large PWM disturbances present in a typical motor control application. The input stage is designed to withstand -5V to +70V common-mode input voltage without damage. The MAX40056 output recovers within 500ns from PWM edges with slew rates up to and beyond  $\pm 500\text{V}/\mu\text{s}$ .

### Low Input Offset Voltage and Low Gain Error

The MAX40056 utilizes chopper-stabilized architecture to achieve a low input offset voltage less than  $\pm 20\mu\text{V}$ . This technique also enables extremely low input offset voltage drift over time and temperature to  $500\text{nV}/^\circ\text{C}$ . The precision input  $V_{\text{OS}}$  specification allows accurate current measurements with low value current-sense resistors, thus reducing voltage drop and power dissipation on sense resistors. The optimized gain architecture achieves a gain error of less than 0.5% over the entire temperature range of  $-40^\circ\text{C}$  to  $+125^\circ\text{C}$ .

### CSA Output

From the functional block diagram shown, the MAX40056 CSA output is given by the following equation

$$V_{OUT} = \{I_{SENSE} \times R_{SENSE}\} \times GAIN + V_{REF} \dots (1)$$

Where,  $I_{SENSE}$  is the current to be measured,  $R_{SENSE}$  is the sense resistor value,  $GAIN$  is the voltage gain of the CSA. The gain is 50V/V for the MAX40056F, 20V/V for the MAX40056T, and 10V/V for the MAX40056U respectively.  $V_{REF}$  is the reference voltage. This is either the internal integrated reference voltage (1.5V) or an external voltage reference connected to the REF input. When the sense current is positive (the current flows from the RS+ input to the RS- input through the sense resistor), the output voltage is greater than  $V_{REF}$  (V), when the sense current is negative, the output voltage is less than  $V_{REF}$  (V) indicating negative currents flowing with respect to RS+ and RS- inputs.

### Voltage Reference

The voltage reference offsets the amplifier output to  $V_{REF}$  when the sensed current is 0A. From Equation (1), the direction of the sensed current can be easily determined by comparing  $V_{OUT}$  with  $V_{REF}$ .

The MAX40056 has an internal 1.5V voltage reference for use with a nominal 3.3V supply. The internal  $V_{REF}$  output can source a small amount current for external loads. The load regulation of the internal reference is 30 $\mu$ V/ $\mu$ A, so care must be taken to ensure that the accuracy of the reference is maintained when the reference is sourcing current.

When operating from higher supply voltages, a higher full-scale output swing is often desired. In this case, the internal reference can be overridden by a higher-voltage external reference. The integrated comparator constantly compares the internal reference voltage and the voltage on the REF input/output so that the higher reference voltage is always selected.

### Window Comparator and Hysteresis

The MAX40056 features an integrated internal window comparator to detect both positive and negative over current conditions. The window comparator (shown in [Figure 2](#)) compares the current sense amplifier output  $V_{OUT}$  with a low threshold ( $V_{CIP}$ ) and a high threshold ( $V_A$ ).  $V_{CIP}$  is generated by an external resistor divider connected to the REF output, and the  $V_{CIP}$  input range should be within 80mV to MIN (( $V_{REF} - 80mV$ ), ( $V_{DD} - 1.25V$ )) for proper operation.  $V_A$  is internally generated from  $V_{REF}$  and  $V_{CIP}$ :  $V_A = (2 \times V_{REF}) - V_{CIP}$ , with a range from ( $V_{REF} + 80mV$ ) to ( $2 \times V_{REF} - 80mV$ ). Either the internal or an external reference can be used to define the thresholds for the integrated window comparators.

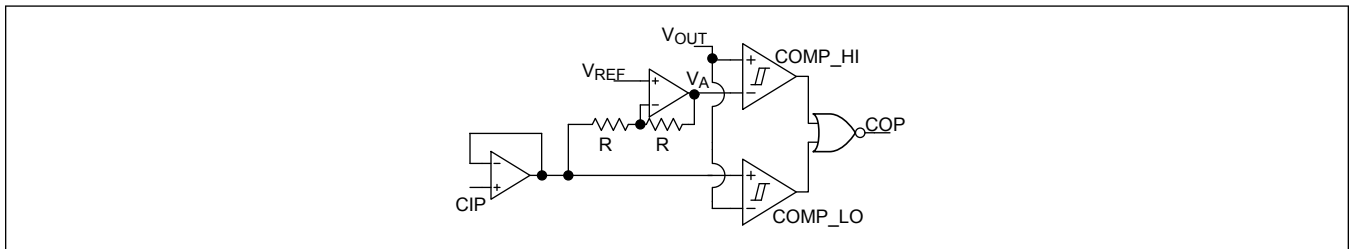

Figure 2. Internal Window Comparator

When  $V_{OUT}$  is greater than  $V_A$  or when  $V_{OUT}$  is less than  $V_{CIP}$ , the comparator output is low, indicating a fault condition. The hysteresis direction is shown in [Figure 3](#). COMP\_HI and COMP\_LO have the same hysteresis direction. When  $V+$  rises across  $V-$ , both comparators have no hysteresis voltage; when  $V+$  falls across  $V-$ , both comparators have a similar hysteresis voltage, thereby providing equivalent noise immunity.

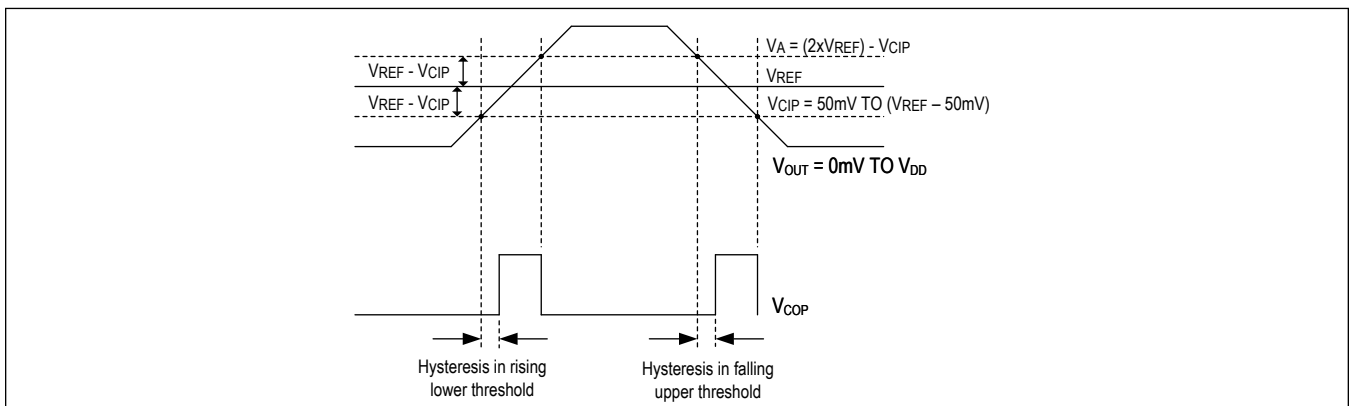

Figure 3. Window Comparator Hysteresis Waveform

## Applications Information

### Input Sense Voltage Range

The maximum input differential voltage range is given by the following relation:

$$V_{\text{SENSE}} = \left\{ \frac{\{ \text{GND} - V_{\text{REF}} \}}{\text{GAIN}} \text{ TO } \frac{\{ V_{\text{DD}} - V_{\text{REF}} \}}{\text{GAIN}} \right\}$$

If  $V_{\text{DD}} = +3.3\text{V}$  and the MAX40056T (Gain = 20V/V) is used with the 1.5V internal reference, the above equation would provide

$$V_{\text{SENSE}} = \left\{ \frac{\{ 0\text{V} - 1.5\text{V} \}}{20\text{V/V}}, \frac{\{ 3.3\text{V} - 1.5\text{V} \}}{20\text{V/V}} \right\} = -75\text{mV TO } +90\text{mV}$$

For further information on input differential voltage range for different  $V_{\text{DD}}$  and choice of reference, please refer to [Table 1](#). Refer to the [Electrical Characteristics](#) for the Gain Error specifications. The typical gain error performance for input differential sense range beyond the specified conditions, as shown below.

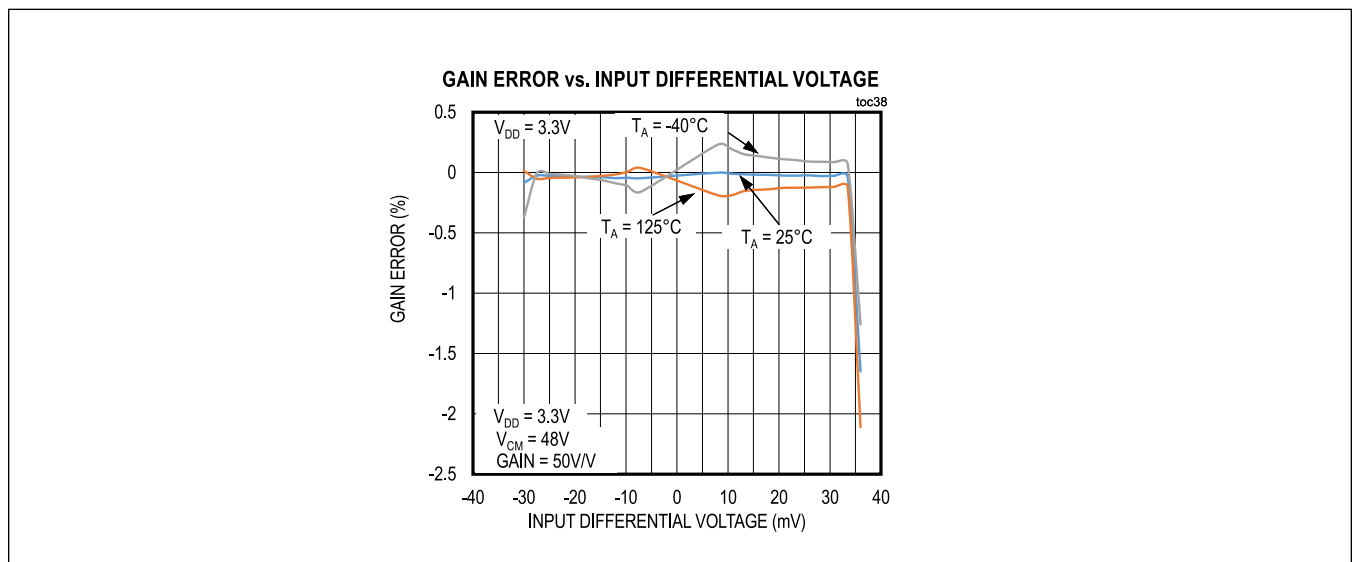

### Choice of Reference Voltage

As the input full scale range is proportional to the  $V_{REF}$  and  $V_{DD}$ , the input differential sense range can be extended by using an external voltage reference and a higher supply voltage. To achieve the maximum possible input and output range, it is recommended to choose a reference voltage that is half of the supply voltage ( $V_{DD}$ ). As an example, when  $V_{DD} = 5.0V$ , select  $V_{REF} = 2.5V$ . Note that the internal reference may be used with higher supply voltage. The low-side output swing will be the same as for low supply voltages, and the high side swing it is recommended to have the reference voltage to the MAX40056 to be half of the supply voltage. For example, when  $V_{DD} = 5.0V$ , select  $V_{REF} = 2.5V$ . [Table 1](#) lists the examples of  $V_{DD}$ ,  $V_{REF}$ , GAIN, and sense voltage combinations.

**Table 1. Examples of  $V_{DD}$ ,  $V_{REF}$ , and Sense Voltage Ranges**

DEVICE	GAIN (V/V)	SUPPLY VOLTAGE (V)	INTERNAL REFERENCE (V)	EXTERNAL REFERENCE (V)	INPUT DIFFERENTIAL SENSE RANGE $V_{SENSE\_FS}$ (mV)
MAX40056F	50	3.3	1.5	–	-30 to +36
		5.0	–	2.5	-50 to +50
MAX40056T	20	3.3	1.5	–	-75 to +90
		5.0	–	2.5	-125 to +125
MAX40056U	10	3.3	1.5	–	-150 to +180
		5.0	–	2.5	-250 to +250

The internal 1.5V integrated reference can be used as a reference for higher supply voltages ( $V_{DD}$ ). The range of input range is extended only on the positive direction.



## Important Considerations

### Kelvin Connections

Due to the high currents that may flow through  $R_{SENSE}$ , take care to eliminate solder and parasitic trace resistance from causing errors in the sense voltage. Either use a four-terminal current sense resistor or use Kelvin (force and sense) PCB layout techniques.

Figure 4 shows a typical routing of Kelvin-sensed traces to the inputs of the MAX40056. The Kelvin-sense traces should be as close as possible to the current-sense resistor's solder contact pads. If the Kelvin-sensing contact pads are spaced wider relative to the sense resistor, error is introduced from the additional trace resistance.

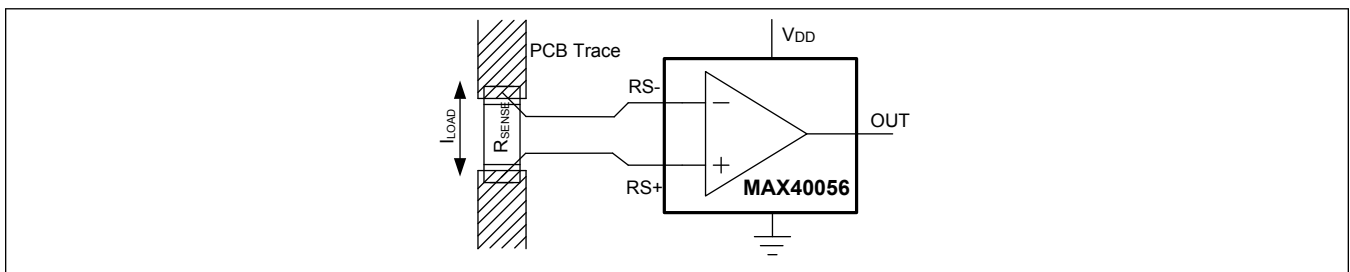

Figure 4. Kelvin Sensing

### Stray Inductance

The stray inductance due to package parasitics in the current sense resistor should be kept minimum. The unwanted voltage error produced of the stray inductance is proportional to the magnitude of the load current. Wire-wound resistors have the highest inductance, while metal film is comparably better.

Low-inductance, metal-film resistors are also available. Instead of being spiral wrapped around a core, as in metal-film or wire wound resistors, they are straight bands of metal and are available in values under 100mΩ.

Typical Application Circuits

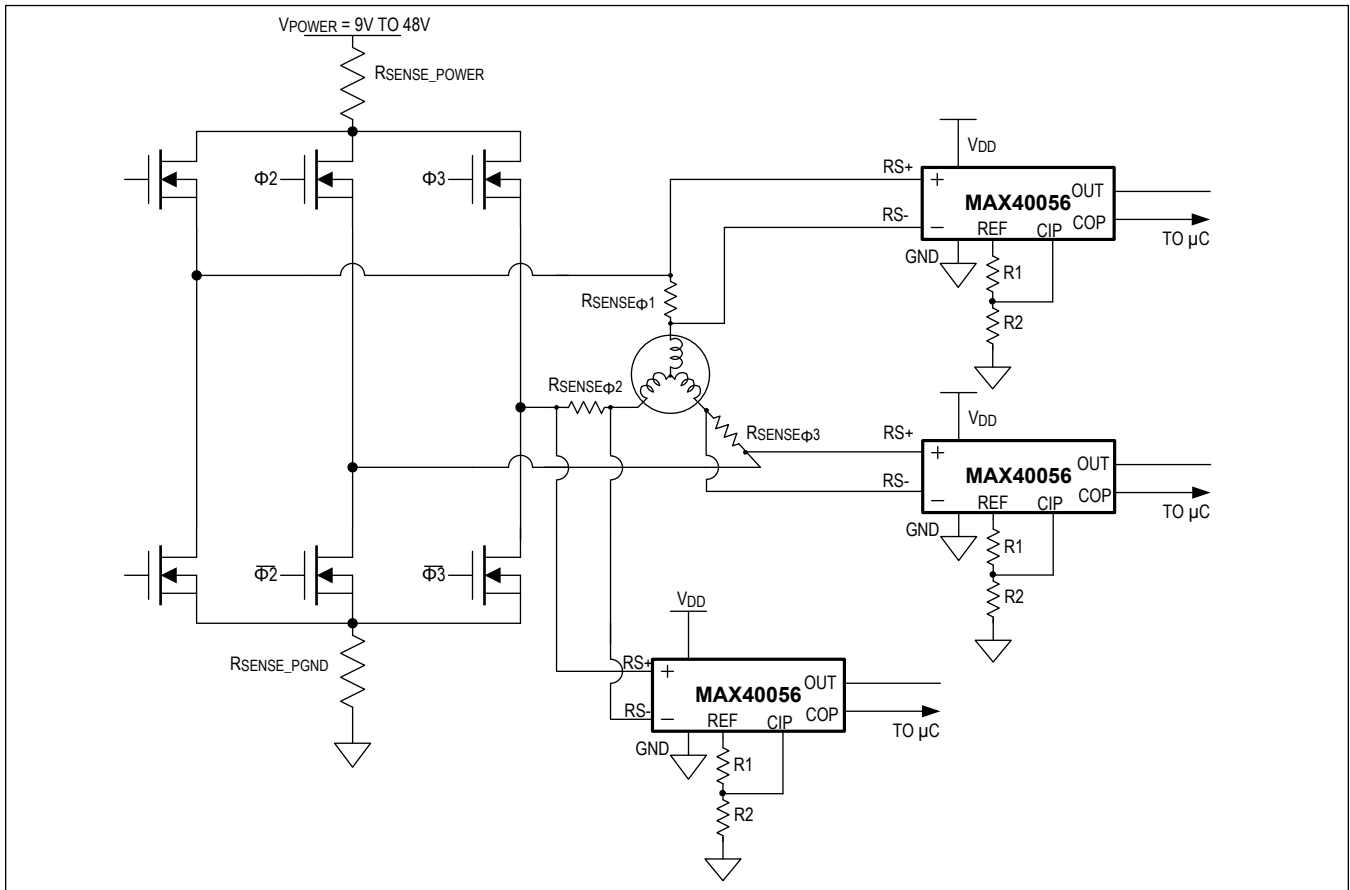

Figure 5. In-Line Current Sensing in Motor Control

Figure 5 shows a typical 3-Phase motor control application. The MAX40056s are connected across the  $R_{SENSE}$  resistors to determine the instantaneous in-line phase currents going into the motor.

Typical Application Circuits (continued)

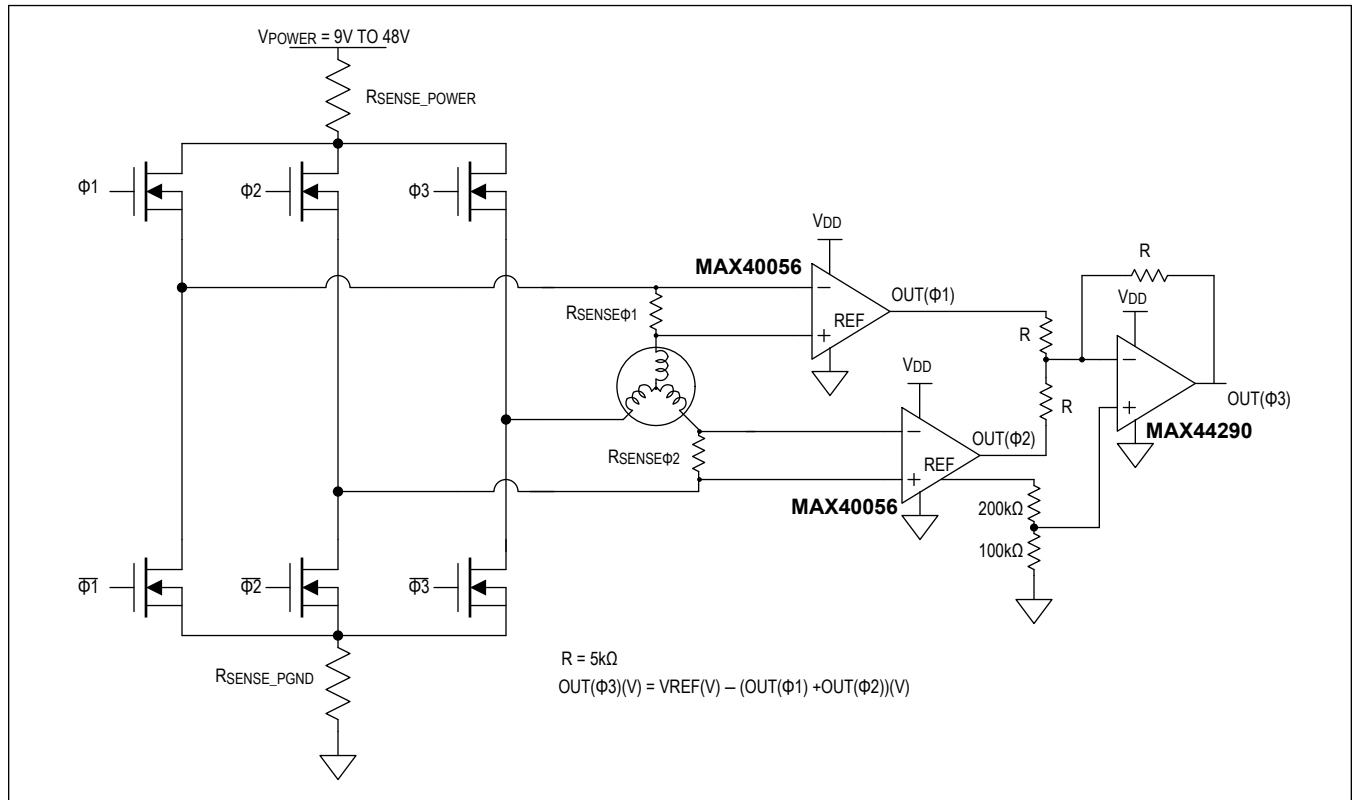

Figure 6. Current Sensing in a 3-Phase Servo Motor

Current Sensing in a 3-Phase Servo Motor

The outputs of two current sense amplifiers can be summed, as shown in [Figure 6](#), to generate a voltage representing the third winding's current.

By Kirchhoff's Law, the third winding current equals the sum of the other two windings, so a simple op-amp summing circuit with three equal-valued resistors is sufficient to produce a voltage proportional to third winding current. Select a large enough resistor value to avoid excessively loading the op-Amp or the CSA outputs. All three amplifiers share the system reference voltage, allowing ratio-metric measurements. If the three amplifiers drive ADC inputs, they will typically share the ADC's supply voltage.

This circuit provides instantaneous winding currents of all three phases without any further computation or knowledge of the PWM pulse phases or duty cycles. Note that the supply bypass capacitors, transient suppressors and catch diodes were omitted for clarity.

### Ordering Information

PART NUMBER	TEMP RANGE	PIN-PACKAGE	TOP MARK	GAIN
MAX40056FAUA+	-40°C to +125°C	8 $\mu$ MAX	+FAUA	50V/V
MAX40056FAUA/V+	-40°C to +125°C	8 $\mu$ MAX	+FA/V	50V/V
MAX40056FAWA+*	-40°C to +125°C	8 WLP	—	50V/V
MAX40056TAUA+	-40°C to +125°C	8 $\mu$ MAX	—	20V/V
MAX40056TAUA/V+*	-40°C to +125°C	8 $\mu$ MAX	+TA/V	20V/V
MAX40056TAWA+*	-40°C to +125°C	8 WLP	+AAP	20V/V
MAX40056UAUA+*	-40°C to +125°C	8 $\mu$ MAX	—	10V/V
MAX40056UAUA/V+	-40°C to +125°C	8 $\mu$ MAX	+UA/V	10V/V
MAX40056UAWA+*	-40°C to +125°C	8 WLP	+AAQ	10V/V

+Denotes a lead(Pb)-free/RoHS-compliant package.

\*Future product—contact factory for availability.

## Revision History

REVISION NUMBER	REVISION DATE	DESCRIPTION	PAGES CHANGED
0	8/18	Initial release	—
1	1/19	Updated <i>Ordering Information</i> and <i>Applications</i>	1, 21
2	5/19	Updated <i>Benefits and Features</i> , <i>Electrical Characteristics</i> , and <i>Detailed Description</i>	1, 4, 12
3	6/19	Updated <i>Ordering Information</i>	20
4	8/19	Updated <i>Input Common Mode</i> specification in <i>Electrical Characteristics</i> table	3
5	11/19	Updated <i>Ordering Information</i>	20

For pricing, delivery, and ordering information, please visit Maxim Integrated's online storefront at <https://www.maximintegrated.com/en/storefront/storefront.html>.

Maxim Integrated cannot assume responsibility for use of any circuitry other than circuitry entirely embodied in a Maxim Integrated product. No circuit patent licenses are implied. Maxim Integrated reserves the right to change the circuitry and specifications without notice at any time. The parametric values (min and max limits) shown in the *Electrical Characteristics* table are guaranteed. Other parametric values quoted in this data sheet are provided for guidance.