

REVISIONS			
REV	ECN, ERN NO.	DATE	APPRD.
E	PRODUCT DWG PER EAR 14658	MAY07/18	K.L.

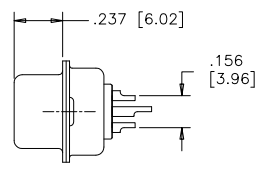
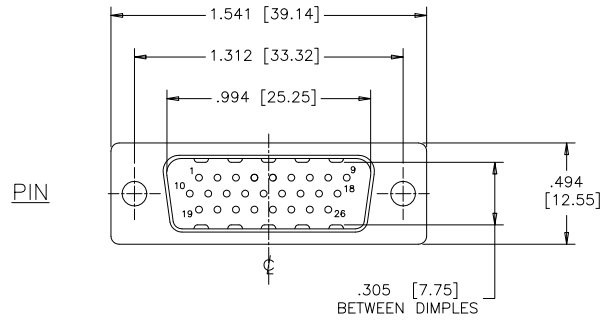

**ORDERING CODE:**

PART NUMBER: 1 7 E H D - 0 2 6 P A M - 1 0 0

**SERIES**

NUMBER OF CONTACTS  
026

STYLE  
P=PIN  
S=SOCKET

**TERMINATION-MOUNTING OPTIONS**  
 000= SOLDER CUP, .120 [3.05] DIA. THROUGH HOLE  
 100= SOLDER CUP, #4-40 UNC THREADED HOLES  
 200= SOLDER CUP, #4-40 UNC HEX JACK SOCKETS INSTALLED

**CONTACT PLATING OPTIONS FOR ENGAGEMENT AREA**  
 AA= GOLD FLASH  
 CH= 15µ" [0.38 MICRONS] GOLD  
 AM= 30µ" [0.76 MICRONS] GOLD

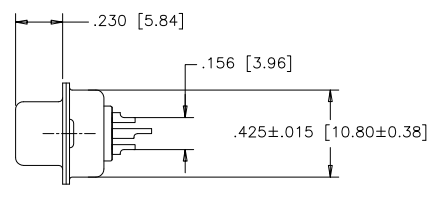
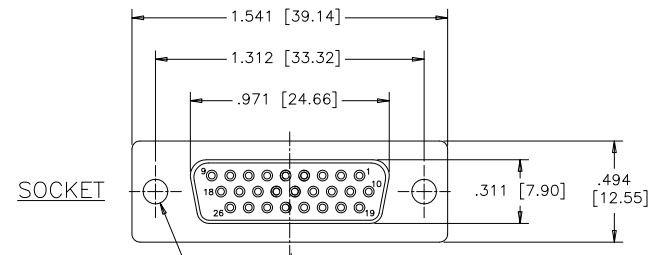

**SPECIFICATIONS:**

**MATERIALS:** ALL MATERIALS ARE RoHS COMPLIANT  
**SHELL:** STEEL, NICKEL PLATED  
**INSERTS:** ENGINEERING THERMOPLASTIC PBT, GLASS REINFORCED, UL FLAMMABILITY RATING 94V-0, COLOUR: BLACK  
**CONTACTS:** COPPER ALLOY, GOLD PLATING (SEE ORDERING CODE) OVER 50µ" [1.27 MICRONS] NICKEL ON ENGAGEMENT AREA WITH 100µ" [2.54 MICRONS] MIN. MATTE TIN ON CONTACT TERMINALS.

TERMINATION-MTG OPTION 000  
 SOLDER CUP,  
 .120 [3.05] DIA.  
 THROUGH HOLE (2 PLACES)

**ELECTRICAL DATA:**

**CURRENT RATING:** 3 AMP  
**CONTACT RESISTANCE:** 15 MILLIOHMS MAX.  
**INSULATION RESISTANCE:** 3000 MEGOHMS MIN.  
**DIELECTRIC WITHSTANDING VOLTAGE:** 1000 VAC rms  
**OPERATING TEMPERATURE:** -55°C TO +105°C

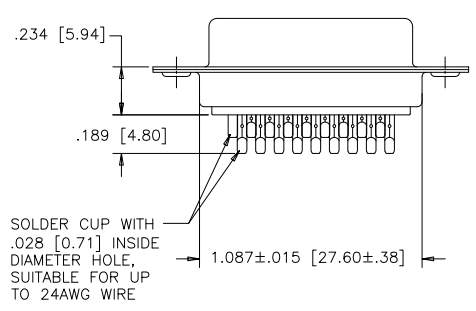

SOLDER CUP WITH .028 [0.71] INSIDE DIAMETER HOLE, SUITABLE FOR UP TO 24AWG WIRE

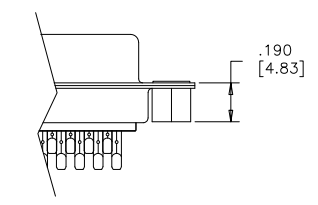

TERMINATION-MTG OPTION 100  
 SOLDER CUP,  
 #4-40 UNC THREADED THROUGH HOLES

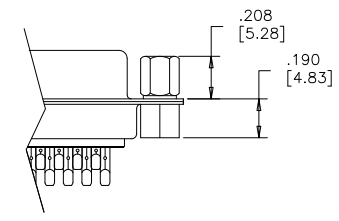

TERMINATION-MTG OPTION 200  
 SOLDER CUP,  
 #4-40 UNC HEX JACK SOCKETS INSTALLED



DRAWN	J.LEE	DATE	OCT03/06
DESIGNED			
CHECKED	K.LAMBIE	DATE	OCT03/06
I. E. APPRD.			
Q. A. APPRD.			
DWG. APPRD.			
ENG. REL. NO.		DWG	DRAWING NO.
REF.	EAR 12956	C	P-17EHD-026XXX-X00
DIMENSIONS ARE IN	INCHES	CODE ID. NO.	03554

Amphenol Canada Corp.			
TITLE 17EHD SERIES HIGH DENSITY D-SUB CONNECTOR, 26 SIZE, SOLDER CUP, PLATING & MOUNTING OPTIONS, RoHS COMPLIANT			
DWG	DRAWING NO.	REV.	
C	P-17EHD-026XXX-X00	E	
DIMENSIONS ARE IN	INCHES	SCALE	2/1
CODE ID. NO.	03554	WT.	
SURF.		SHEET	1 OF 1

THIS DOCUMENT CONTAINS PROPRIETARY INFORMATION AND SUCH INFORMATION MAY NOT BE DISCLOSED TO OTHERS FOR ANY PURPOSE OR USED FOR MANUFACTURING PURPOSES WITHOUT WRITTEN PERMISSION FROM AMPHENOL CANADA CORP.

# Mouser Electronics

Authorized Distributor

Click to View Pricing, Inventory, Delivery & Lifecycle Information:

## Amphenol:

[17EHD026PAA100](#) [17EHD026PAA200](#) [17EHD026PAM000](#) [17EHD026PAM100](#) [17EHD026PAM200](#)  
[17EHD026SAA100](#) [17EHD026SAA200](#) [17EHD026SAM000](#) [17EHD026SAM100](#) [17EHD026SAM200](#) [17EHD-026S-AA000](#)