

# LTM4676AEY

## 130A Step-Down $\mu$ Module Regulator with PMBus Power System Management

### DESCRIPTION

Demonstration circuit 2106B-B is a high efficiency, high density,  $\mu$ Module regulator with 4.5V to 16V input range. The output voltage is adjustable from 0.5V to 1.8V, and it can supply 130A maximum load current. The demo board has 1 $\times$  LTM<sup>®</sup>4676A and 3 $\times$  LTM4630  $\mu$ Module regulators. The LTM4676A is a dual 13A or single 26A step-down regulator with PMBus power system management, and the LTM4630 is a dual 18A or single 36A step-down regulator. Please see LTM4676A and LTM4630 data sheets for more detailed information.

DC2106B-B powers up to default settings and produces power based on configuration resistors without the need for any serial bus communication. This allows easy evaluation of the DC/DC converter. To fully explore the extensive power system management features of the part, download the GUI software LTpowerPlay<sup>™</sup> onto your PC and use

LTC's I<sup>2</sup>C/SMBus/PMBus dongle DC1613A to connect to the board. LTpowerPlay allows the user to reconfigure the part on the fly and store the configuration in EEPROM, and view telemetry of voltage, current, temperature and fault status.

### GUI Download

The software can be downloaded from:

<http://www.linear.com/ltpowerplay>

For more details and instructions of LTpowerPlay, please refer to LTpowerPlay GUI for LTM4676A Quick Start Guide.

**Design files for this circuit board are available at**  
<http://www.linear.com/demo/DC2106B-B>

LT, LT, LTC, LTM, Linear Technology, the Linear logo, Dust Networks, Dust and PolyPhase are registered trademarks and LTpowerPlay is a trademark of Linear Technology Corporation. All other trademarks are the property of their respective owners.

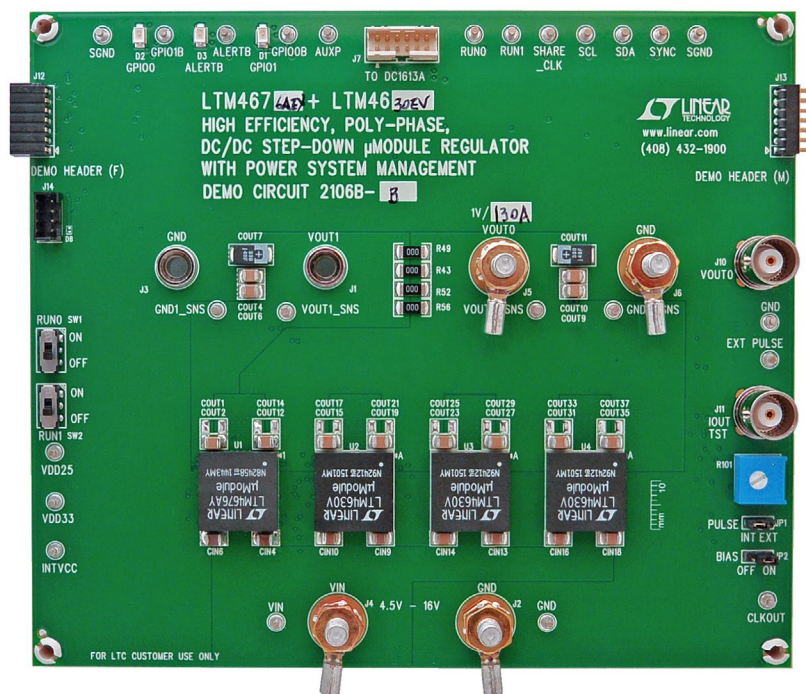

Figure 1. LTM4676A/DC2106B-B Demo Circuit

# DEMO MANUAL DC2106B-B

## PERFORMANCE SUMMARY Specifications are at $T_A = 25^\circ\text{C}$

PARAMETER	CONDITION	VALUE
Input Voltage Range		4.5V to 16V
Output Voltage, $V_{OUT0}$	$V_{IN} = 4.5\text{V to }16\text{V}$ , $I_{OUT0} = 0\text{A to }130\text{A}$	0.5V to 1.8V, Default: 1V
Maximum Output Current, $I_{OUT0}$	$V_{IN} = 4.5\text{V to }16\text{V}$ , $V_{OUT} = 0.5\text{V to }1.8\text{V}$	130A
Typical Efficiency	$V_{IN} = 12\text{V}$ , $V_{OUT} = 1\text{V}$ , $I_{OUT} = 130\text{A}$	82.9%
Default Switching Frequency		350kHz

## QUICK START PROCEDURE

Demonstration circuit 2106B-B is easy to set up to evaluate the performance of the LTM4676AEY. Refer to Figure 2 for the proper measurement equipment setup and follow the procedure below.

1. With power off, connect the input power supply to  $V_{IN}$  (4.5V to 16V) and GND (input return).
2. Connect the output load between  $V_{OUT0}$  and GND (Initial load: no load).
3. Connect the DVMs to the input and outputs. Set default switch position: SW1: ON; SW2: ON.
4. Turn on the input power supply and check for the proper output voltages.  $V_{OUT0}$  should be  $1\text{V} \pm 1\%$ .
5. Once the proper output voltages are established, adjust the loads within the operating range and observe the output voltage regulation, ripple voltage and other parameters.

6. Connect the dongle and control the output voltages from the GUI. See “LTpowerPlay GUI for the LTM4676A Quick Start Guide” for details.

Note: When measuring the output or input voltage ripple, do not use the long ground lead on the oscilloscope probe. See Figure 3 for the proper scope probe technique. Short, stiff leads need to be soldered to the (+) and (–) terminals of an output capacitor. The probe’s ground ring needs to touch the (–) lead and the probe tip needs to touch the (+) lead.

### Connecting a PC to DC2106B-B

You can use a PC to reconfigure the power management features of the LTM4676A such as: nominal  $V_{OUT}$ , margin set points, OV/UV limits, temperature fault limits, sequencing parameters, the fault log, fault responses, GPIOs and other functionality. The DC1613A dongle may be plugged when  $V_{IN}$  is present.

Table 1. LTM4676/LTM4676A Demo Cards for Up to 130A Point-of-Load Regulation

MAXIMUM OUTPUT CURRENT	NUMBER OF OUTPUT VOLTAGES	NUMBER OF LTM4676/LTM4676A $\mu$ MODULE REGULATORS ON THE BOARD	DEMO BOARD NUMBER
13A, 13A	2	1x LTM4676	DC1811A/DC1811B-A
13A, 13A	2	1x LTM4676A	DC1811B-B
26A	1	1x LTM4676	DC2087A
50A	1	2x LTM4676	DC1989A-A
75A	1	3x LTM4676	DC1989A-B
100A	1	4x LTM4676	DC1989A-C
100A	1	1x LTM4676 (+ 3x LTM4620A)	DC2106A-A
130A	1	1x LTM4676 (+ 3x LTM4630)	DC2106A-B
100A	1	1x LTM4676A (+ 3x LTM4620A)	DC2106B-A
130A	1	1x LTM4676A (+ 3x LTM4630)	DC2106B-B

**QUICK START PROCEDURE**

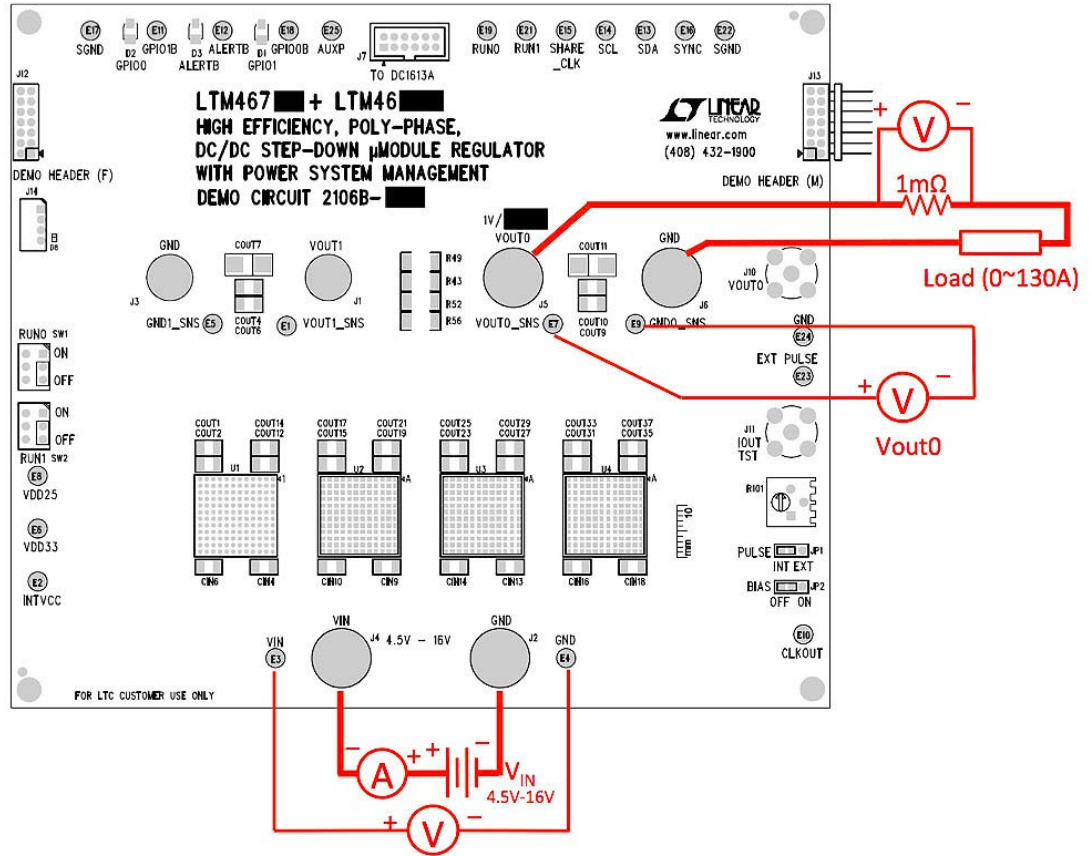

Figure 2. Proper Measurement Equipment Setup

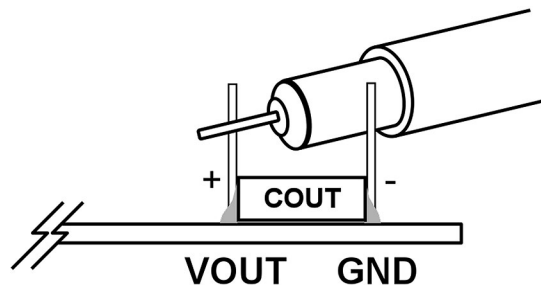

Figure 3. Measuring Output Voltage Ripple

## QUICK START PROCEDURE

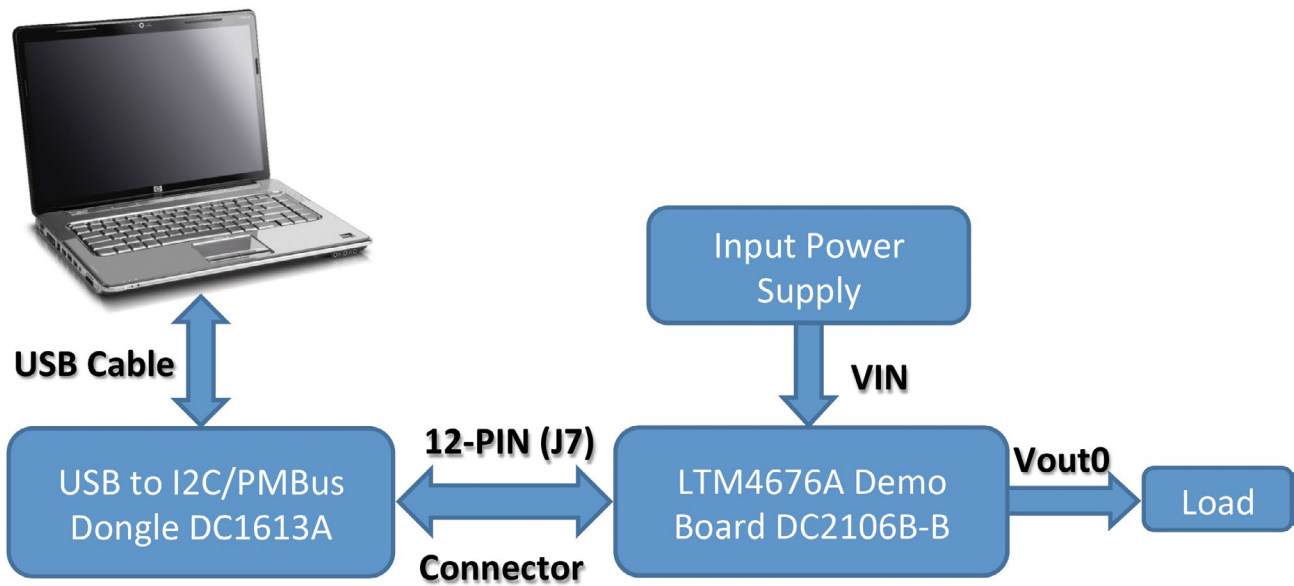

Figure 4. Demo Setup with PC

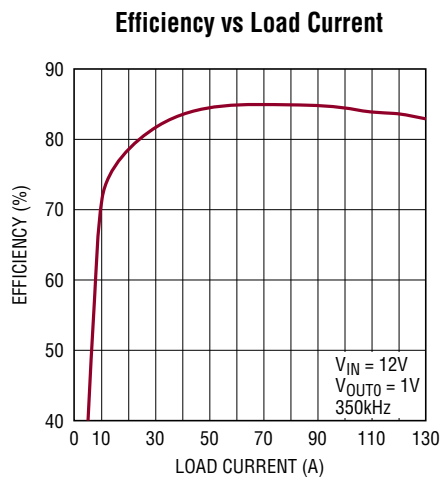
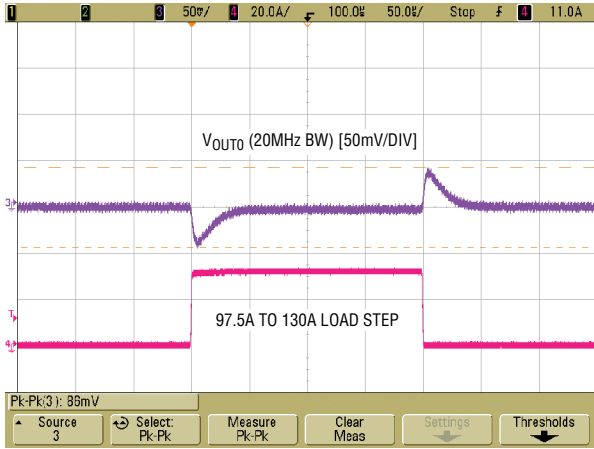
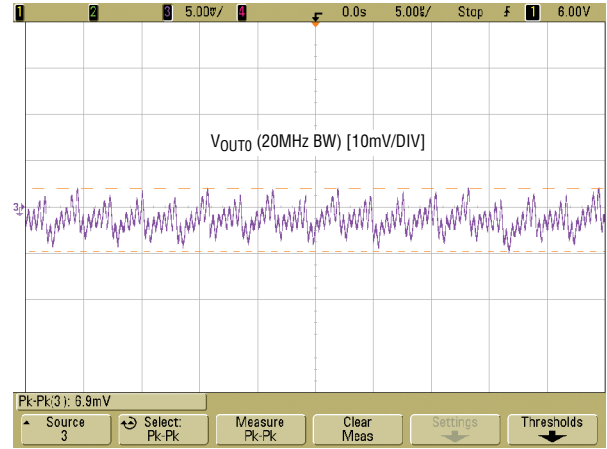

Figure 5. Efficiency vs Load Current at  $V_{IN} = 12V$

**QUICK START PROCEDURE**



**Figure 6. Output Voltage  $V_{OUTO}$  vs Load Current ( $V_{OUTO}$  RANGE = 0)**



**Figure 7. Output Voltage Ripple at  $V_{IN} = 12V$ ,  $V_{OUTO} = 1V$ ,  $I_{OUTO} = 130A$**

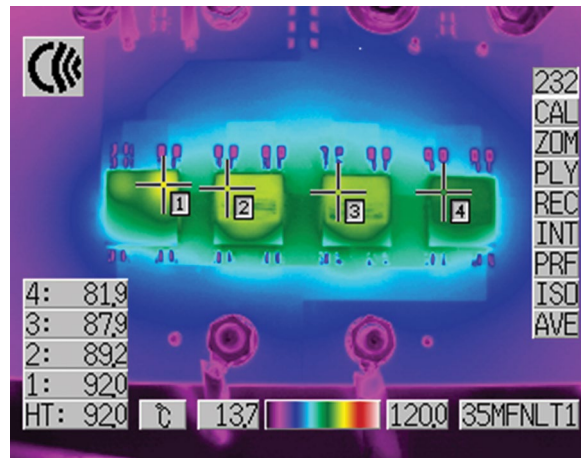

**Figure 8. Thermal Performance at  $V_{IN} = 12V$ ,  $V_{OUTO} = 1V$ ,  $I_{OUTO} = 130A$ ,  $T_A = 23.3^{\circ}C$ , Air Flow 300LFM**

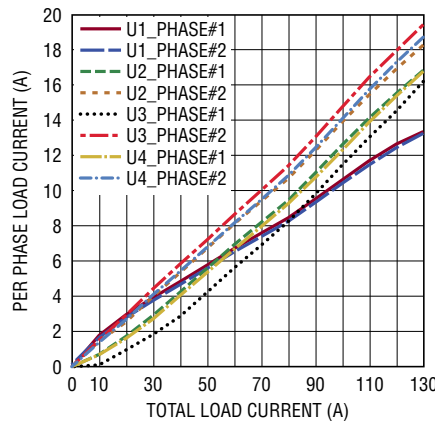

**Figure 9. Current Sharing Performance at  $V_{IN} = 12V$ ,  $V_{OUTO} = 1V$**



## QUICK START PROCEDURE

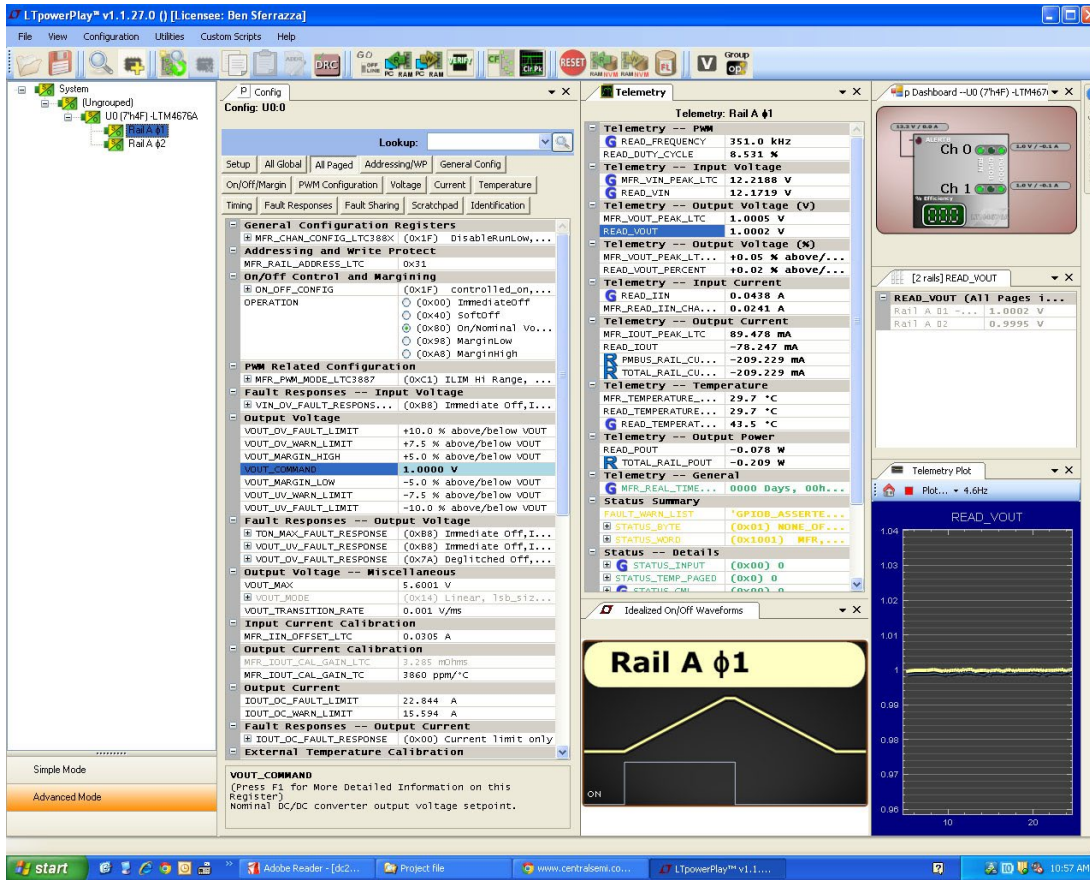

Figure 10. LTpowerPlay Main Interface

### LTpowerPlay Software GUI

LTpowerPlay is a powerful Windows based development environment that supports Linear Technology power system management ICs, including the LTM4676A, LTC3880, LTC3883, LTC2974 and LTC2978. The software supports a variety of different tasks. You can use LTpowerPlay to evaluate Linear Technology ICs by connecting to a demo board system. LTpowerPlay can also be used in an offline mode (with no hardware present) in order to build a multichip configuration file that can be saved and reloaded at a later time. LTpowerPlay provides unprecedented diagnostic and debug features. It becomes a valuable diagnostic tool during board bring-up to program or tweak the power management scheme in a system, or to diagnose power issues when bringing up rails. LTpowerPlay utilizes the DC1613A USB-to-SMBus controller to communicate with one of many potential targets, including the LTM4676, the

LTC3880 and the LTC3883's demo system, or a customer board. The software also provides an automatic update feature to keep the software current with the latest set of device drivers and documentation. The LTpowerPlay software can be downloaded from:

<http://linear.com/ltpowerplay>

To access technical support documents for LTC Digital Power Products visit Help. View online help on the LTpowerPlay menu.

### LTpowerPlay QUICK START PROCEDURE

The following procedure describes how to use LTpowerPlay to monitor and change the settings of LTM4676A.

1. Download and install the LTpowerPlay GUI:

<http://linear.com/ltpowerplay>

## QUICK START PROCEDURE

2. Launch the LTpowerPlay GUI.

- a. The GUI should automatically identify the DC2106B-B. The system tree on the left hand side should look like this:



- b. A green message box shows for a few seconds in the lower left hand corner, confirming that LTM4676A is communicating:

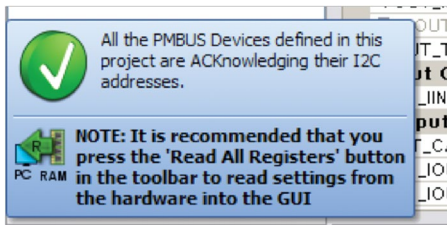

- c. In the Toolbar, click the “R” (RAM to PC) icon to read the RAM from the LTM4676A. This reads the configuration from the RAM of LTM4676A and loads it into the GUI.



- d. If you want to change the output voltage to a different value, like 1.5V. In the Config tab, type in 1.5 in the VOUT\_COMMAND box, like this:

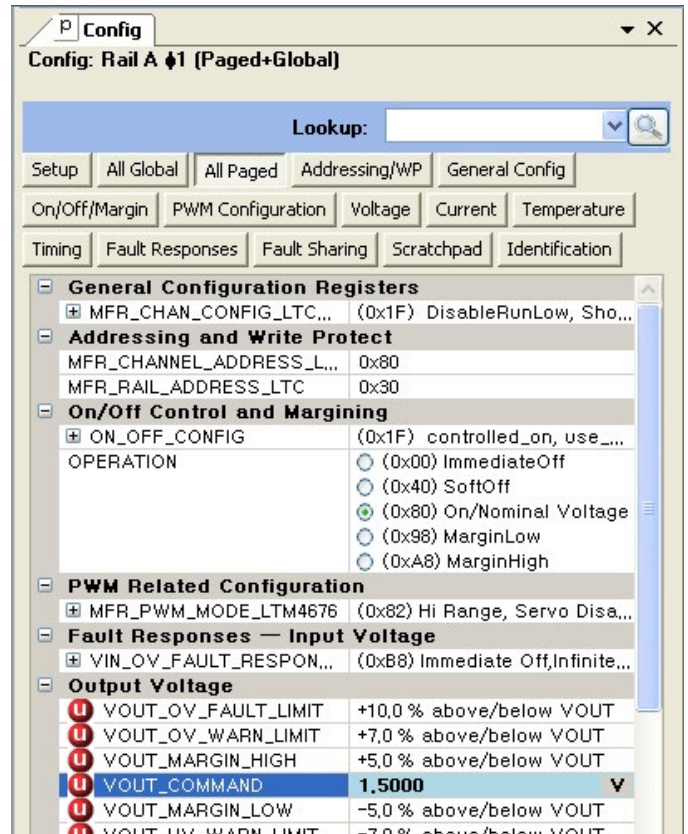

Then, click the “W” (PC to RAM) icon to write these register values to the LTM4676A. After finishing this step, you will see the output voltage will change to 1.5V.



If the write is successful, you will see the following message:



- e. You can save the changes into the NVM. In the tool bar, click “RAM to NVM” button, as following



- f. Save the demo board configuration to a (\*.proj) file. Click the Save icon and save the file. Name it whatever you want.

# DEMO MANUAL DC2106B-B

## PARTS LIST

ITEM	QTY	REFERENCE	PART DESCRIPTION	MANUFACTURER/PART NUMBER
<b>Required Circuit Components</b>				
1	18	CIN1, CIN2, CIN4, CIN5, CIN6, CIN7, CIN8, CIN9, CIN10, CIN11, CIN12, CIN13, CIN14, CIN15, CIN16, CIN17, CIN18, CIN19	CAP, X5R, 10µF, 35V, 10%, 1210	NIC NMC1210X5R106K35TRPLPF
2	1	CIN3	CAP, 150µF, 35V, ALUMINUM ELECTR	SUN ELECT, 35CE150AX
3	21	COUT1, COUT2, COUT3, COUT4, COUT6, COUT9, COUT10, COUT12, COUT13, COUT15, COUT16, COUT19, COUT20, COUT23, COUT24, COUT27, COUT28, COUT31, COUT32, COUT35, COUT36	CAP, X5R, 100µF, 6.3V, 20% 1210	MURATA, GRM32ER60J107M20L
4	10	COUT5, COUT7, COUT18, COUT22, COUT26, COUT30, COUT34, COUT38, COUT8, COUT11	CAP, 330µF, 6.3V, POSCAP, D4	SANYO, 6TPF330M9L
5	1	C5	CAP, X7R, 2.2nF, 16V, 10%, 0603	AVX, 0603YC222KAT2A
6	4	C7, C8, C33, C34	CAP, X7R, 10nF, 16V, 10%, 0603	AVX, 0603YC103KAT2A
7	3	C11, C18, C22	CAP, X5R, 2.2µF, 16V, 10%, 0603	TDK, C1608X5R1C225K
8	3	C12, C19, C23	CAP, X7R, 1µF, 16V, 10%, 0603	AVX, 0603YC105KAT2A
9	2	C31, C28	CAP, X7R, 1µF, 25V, 10%, 1206	AVX, 12063C105KAT2A
10	1	C25	CAP, X7R, 0.22µF, 25V, 10%, 0805	AVX, 08053D224KAT2A
11	1	C26	CAP, X7R, 0.1µF, 25V, 10%, 1206	AVX, 12063C104KAT2A
12	1	C29	CAP, X5R, 1µF, 25V, 10%, 0805	AVX, 08053D105KAT2A
13	1	C27	CAP, X7R, 150pF, 25V, 10%, 0603	AVX, 06033C151KAT2A
14	1	C30	CAP, X5R, 4.7µF, 10V, 10%, 0603	AVX, 0603ZD475KAT2A
15	2	D1, D2	LED GREEN S-GW TYPE SMD	ROHM SML-010FTT86
16	1	D3	LED RED S-TYPE GULL WING SMD	ROHM SML-010VTT86
17	1	D10	DIODE, ULTRA LOW SCHOTTKY RECTIFIER	NXP SEMI PMEG2005AEL, 315
18	3	Q1, Q3, Q4	MOSFET N-CH 60V 115MA SOT-23	FAIRCHILD 2N7002K
19	1	Q2	MOSFET P-CH 20V 0.58A SOT-23	VISHAY TP0101K-T1-E3
20	2	Q5, Q6	MOSFET SPEED SRS 30V 30A LPAK	RENESAS RJK0305DPB
21	1	Q19	P-CHANNEL 30-V MOSFET	DIODE IN, DMP3130L-7
22	1	R25	RES, CHIP, 22.6k, 1%, 0603	VISHAY CRCW060322K6FKEA
23	24	R2, R4, R8, R23, R31, R32, R34, R37, R38, R50, R61, R66, R42, R44, R46, R47, R41, R64, R51, R55, R109, R75, R80, R114	RES, CHIP, 0, 1%, 0603	VISHAY CRCW06030000Z0EA
24	4	R43, R49, R52, R56,	RES, CHIP, 0, 1%, 2010	VISHAY CRCW20100000Z0EA
25	9	R10, R11, R12, R13, R16, R17, R21, R77, R94	RES, CHIP, 10k, 1%, 0603	VISHAY CRCW060310K0FKEA
26	1	R9	RES, CHIP, 7.15k, 1%, 0603	VISHAY CRCW06037K15FKEA
27	4	R22, R26, R70, R73	RES, CHIP, 10, 1%, 0603	NIC NRC06F10R0TRF
28	1	R102	RES, CHIP, 732, 1%, 0603	VISHAY CRCW0603732RFKEA
29	3	R33, R60, R65	RES, CHIP, 121k, 1%, 0603	VISHAY CRCW0603121KFKEA
30	4	R40, R63, R68, R58	RES, CHIP, 80.6k, 1%, 0603	VISHAY CRCW060380K6FKEA
31	1	R35	RES, CHIP, 60.4k, 1%, 0603	VISHAY CRCW060360K4FKEA
32	1	R36	RES, CHIP, 8.25k, 1%, 0603	VISHAY CRCW06038K25FKEA
33	1	R19	RES, CHIP, 7.15k, 1%, 0603	VISHAY CRCW06037K15FKEA
34	4	R45, R84, R85, R98	RES, CHIP, 200, 1%, 0603	VISHAY CRCW0603200RFKEA
35	3	R54, R89, R92	RES, CHIP, 20k, 1%, 0603	VISHAY CRCW060320K0FKEA

dc2106bbf



## PARTS LIST

ITEM	QTY	REFERENCE	PART DESCRIPTION	MANUFACTURER/PART NUMBER
36	2	R76, R115	RES, CHIP, 4.99k, 1%, 0603	PANASONIC ERJ-3EKF4991V
37	1	R86	RES, CHIP, 127, 1%, 0603	VISHAY CRCW0603127RFKEA
38	1	R87	RES, CHIP, 2, 1%, 0603	VISHAY CRCW06032R00FKEA
39	1	R88	RES, CHIP, 1M, 1%, 0603	NIC NRC06F1004TRF
40	1	R90	RES, CHIP, 154k, 1%, 0603	VISHAY CRCW0603154KFKEA
41	1	R91	RES, CHIP, 3.3, 1%, 0603	VISHAY CRCW06033R30FKEA
42	1	R93	RES, CHIP, 681k, 1%, 0603	VISHAY CRCW0603681KFKEA
43	1	R95	RES, CHIP, 82.5, 1%, 0603	VISHAY CRCW060382R5FKEA
44	1	R112	RES, CHIP, 15.8k, 1%, 0603	VISHAY CRCW060315K8FKEA
45	2	R99, R100	RES, CHIP, 0.01, 1%, 2010	VISHAY WSL2010R0100FEA
46	1	R101	TRIMMING POTENTIOMETER, 5k	BOURNS, 3386P-1-502LF
47	1	R103	RES, CHIP, 100k, 1%, 0603	VISHAY CRCW0603100KFKEA
48	1	U1	IC, LTM4676AEY	LINEAR TECH LTM4676AEY
49	3	U2, U3, U4	IC, LTM4630EV	LINEAR TECH LTM4630EV
50	1	U5	IC, LT1801CMS8, MSOP	LINEAR TECH LT1801CMS8
51	1	U6	IC, 24LC025T-E/OT SOT-23 6-LEAD	MICROCHIP, 24LC025T-E/OT
52	1	U7	IC, LTC6992-1, S6-TSOT23	LINEAR TECH LTC6992CS6-1
53	1	U8	IC, LT1803IS5, S5-TSOT23	LINEAR TECH LT1803IS5
54	1	U9	IC, LT1129CS8-5, S8	LINEAR TECH LT1129CS8-5

### Additional Demo Board Circuit Components

1	0	C1, C2, C3, C4, C6, C13, COUT14, COUT17, COUT21, COUT25, COUT29, COUT33, COUT37, C9, C10, C16, C17, C20, C21,	CAP, OPTIONAL	
2	0	R1, R3, R5, R6, R7, R14, R15, R18, R20, R24, R27 TO R30, R39, R48, R59, R62, R67, R69, R72, R78, R79, R96, R97, R104 TO R108, R39, R41, R62, R67, R69	RES, OPTIONAL	

### Hardware: for Demo Board Only

1	24	E1 TO E24	TESTPOINT, TURRET, 0.062"	MILL-MAX, 2308-2-00-80-00-00-07-0
2	2	JP1, JP2	0.079 SINGLE ROW HEADER, 3 PIN	SAMTEC, TMM-103-02-L-S
3	2	XJP1, XJP2	SHUNT	SAMTEC, 2SN-BK-G
4	2	J1, J3	JACK, BANANA	KEYSTONE 575-4
5	4	J2, J4, J5, J6	STUD, TESTPIN	PEM KFH-032-10
6	8	J1, J2, J3, J4, J5, J6 (x2)	NUT, BRASS 10-32	ANY #10-32
7	4	J1, J2, J3, J4, J5, J6	RING, LUG #10	KEYSTONE, 8205, #10
8	4	J1, J2, J3, J4, J5, J6	WASHER, TIN PLATED BRASS	ANY #10, #10EXT BZ TN
9	2	SW1, SW2	CONN, SUB MINIATURE SLIDE SWITCHES	C&K, JS202011CQN
10	1	J7	CONN HEADER 12POS 2MM STR DL PCB	FCI 98414-G06-12ULF
11	2	J10, J11	CONN, BNC, 5PINS	CONNEX, 112404
12	1	J14	HEADER, 4 PINS, SHROUDED	HIROSE, DF3A-4P-2DSA
13	1	J12	CONN RECEPT 2MM DUAL R/A 14POS (F)	SULLINS, NPPN072FJFN-RC
14	1	J13	HEADER 14POS 2MM R/A GOLD (M)	MOLEX, 87760-1416
15	4	(STAND-OFF)	STAND-OFF, NYLON 0.50" TALL	KEYSTONE, 8833(SNAP ON)

# DEMO MANUAL DC2106B-B

## SCHEMATIC DIAGRAM

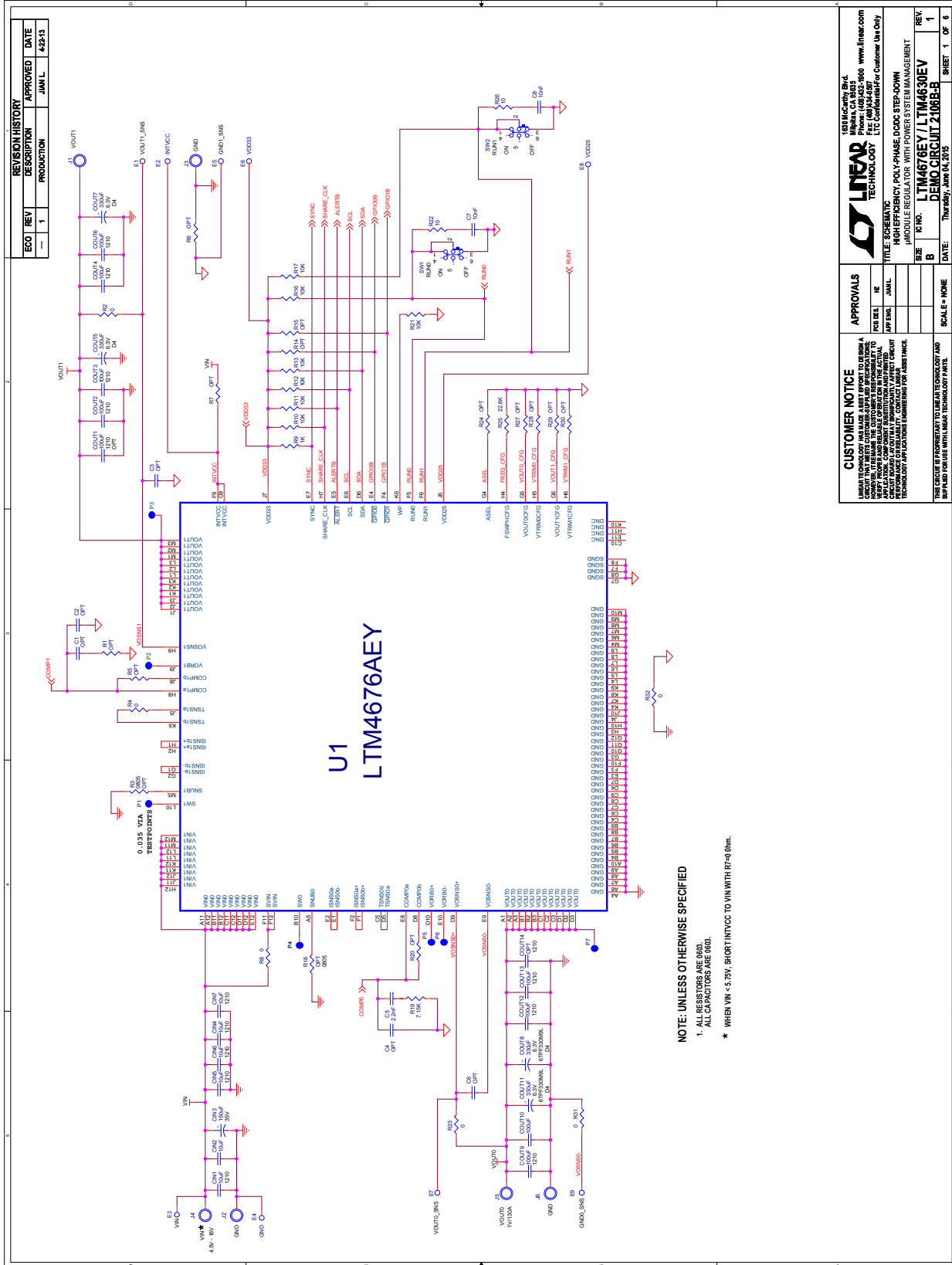

REVISION HISTORY			
ECO	REV	DESCRIPTION	DATE
-	1	PRODUCTION	JAN 11 422-13

**CUSTOMER NOTICE**  
 LINEAR TECHNOLOGY'S POLY-PHASE DCDC STEP-DOWN CONVERTER WITH CURRENT MODE CONTROL AND INDUCTOR CURRENT SENSING IS THE ACTUAL PRODUCT. THIS DEMO CIRCUIT IS A CUSTOMER SUPPORT TOOL. IT IS NOT A REPRESENTATIVE PRODUCT. TECHNOLOGY APPLICATIONS ENGINEERING FOR ASSET TRACE.

**APPROVALS**

FOR FILE	RE
APP ENCL	JMIL

**SCALE = NONE**

**LINEAR TECHNOLOGY**  
 1630 McCarty Blvd.  
 Milpitas, CA 95035  
 Tel: (415) 764-0000 www.linear.com  
 Fax: (415) 764-0071  
 LITE Confidential For Customer Use Only

**TITLE: ESCHEATERS**  
**HIGH EFFICIENCY POLY-PHASE DCDC STEP-DOWN**  
**MODULE REGULATOR WITH POWER SYSTEM MANAGEMENT**

**SIZE** IC NO. **LTM4676EY** LTM4676EY  
**DEMO CIRCUIT 2106B-B**

**REV. 1**  
**DATE: Thursday, June 04, 2015** SHEET 1 OF 6

**NOTE: UNLESS OTHERWISE SPECIFIED**  
 1. ALL RESISTORS ARE 0603.  
 ALL CAPACITORS ARE 0603.  
 \* WHEN VIN < 5.75V, SHORT INVCC TO VIN WITH RT=0 Ohm.

**SCHEMATIC DIAGRAM**

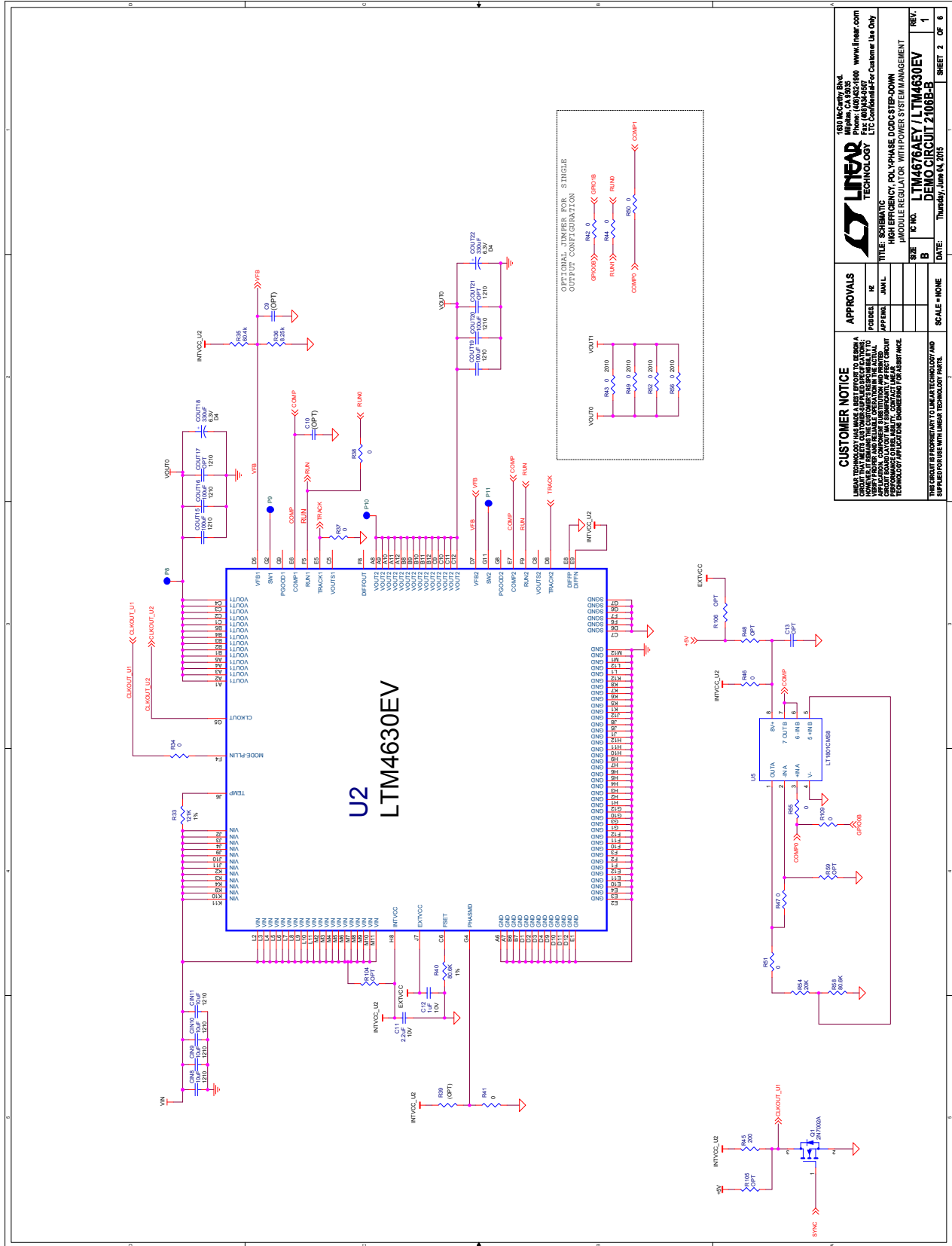

<b>LINEAR TECHNOLOGY</b> 100 Acacia Blvd Milpitas, CA 95035 Phone: (408) 222-1000 www.linear.com	
TITLE: SCHEMATIC HIGH EFFICIENCY, POLY-PHASE, DCMC STEP-DOWN MODULE REGULATOR WITH POWER STEERING MANAGEMENT	
PARTS LIST DATE: Thursday, June 14, 2015	REV: 1 SHEET 2 OF 6

# DEMO MANUAL DC2106B-B

## SCHEMATIC DIAGRAM

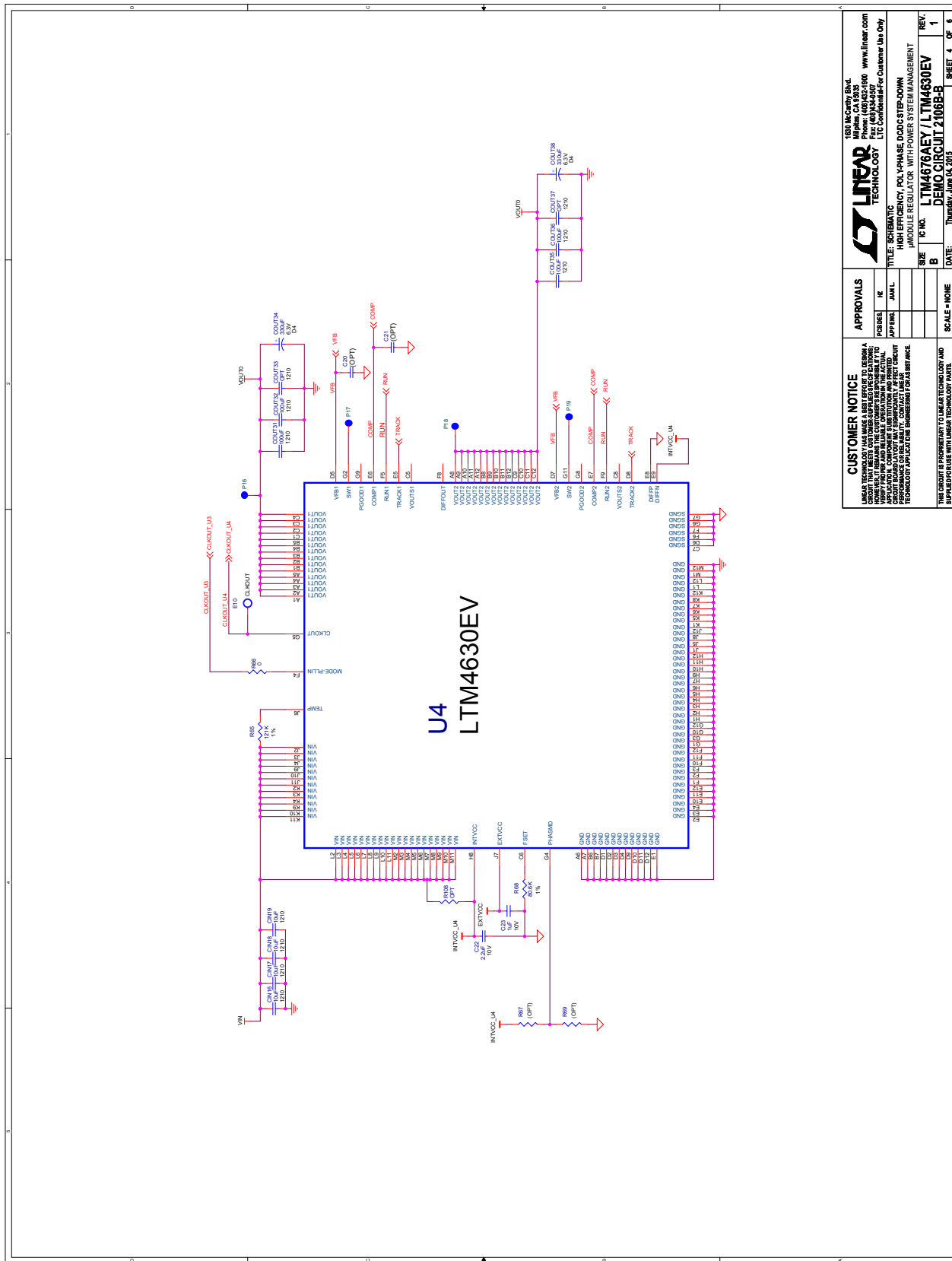

**CUSTOMER NOTICE**  
 LINAER THAT THIS DEMO CIRCUIT IS NOT A RECOMMENDED DESIGN. IT IS PROVIDED AS A REFERENCE ONLY. THE USER MUST VERIFY THAT THE CIRCUIT MEETS ALL REQUIREMENTS FOR THE APPLICATION. THE USER MUST VERIFY THAT THE CIRCUIT MEETS ALL REQUIREMENTS FOR THE APPLICATION. THE USER MUST VERIFY THAT THE CIRCUIT MEETS ALL REQUIREMENTS FOR THE APPLICATION. THE USER MUST VERIFY THAT THE CIRCUIT MEETS ALL REQUIREMENTS FOR THE APPLICATION.

**APPROVALS**

DESIGNED BY	IK
APPROVED BY	JML
SCALE	1:1

**SCALE - NONE**

**DATE:** Thursday, June 14, 2015

**REV:** 1

**SHEET 4 OF 6**

1630 McCarthy Blvd.  
 Milpitas, CA 95035  
 Phone: 408.255.0000  
 Fax: 408.255.2000  
 www.linear.com

**LINEAR TECHNOLOGY**  
 LTM4630EV

**TITLE:** SCHEMATIC FOR POLYPHASE DDP&S STEP DOWN  
 MOBILE REGULATOR WITH POWER SYSTEM MANAGEMENT

**REV:** 1

**DATE:** Thursday, June 14, 2015

**SHEET 4 OF 6**

**SCHEMATIC DIAGRAM**

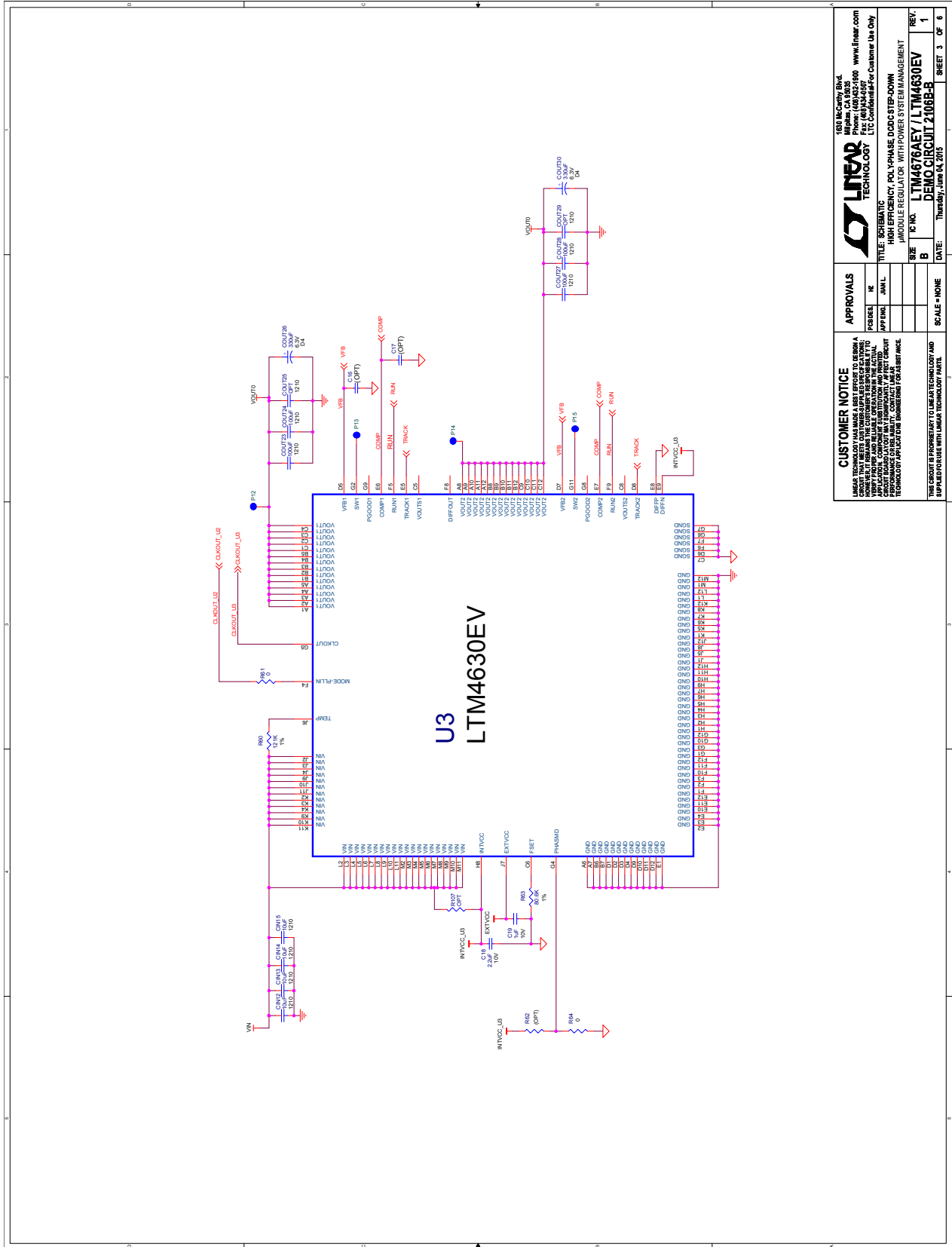

<b>CUSTOMER NOTICE</b>		<b>APPROVALS</b>	
LINEAR TECHNOLOGY HAS MADE A BEST EFFORT TO DESIGN A POWER MANAGEMENT IC AND ASSOCIATED DEMO CIRCUIT TO MEET THE SPECIFICATIONS AND PERFORMANCE CHARACTERISTICS LISTED IN THE PRODUCT DATA SHEET. CUSTOMER USE OF THE IC AND DEMO CIRCUIT IS AT THEIR OWN RISK. LINEAR TECHNOLOGY ASSUMES NO LIABILITY FOR ANY DAMAGE TO PERSONS OR PROPERTY ARISING FROM THE USE OF THE IC OR DEMO CIRCUIT.		DESIGNED BY	DATE
		APPROVED BY	
		DATE	
		SCALE	1 OF 6
		SHEET	3 OF 6
		REV.	1
		REV.	1
		REV.	1

1800 McCarty Blvd.  
**LINEAR**  
 TECHNOLOGY  
 Phone: (408) 432-1000 www.linear.com  
 Fax: (408) 432-4500  
 LTO Combustible For Customer Use Only

TITLE: SCHEMATIC  
 HIGH EFFICIENCY, POLY-PHASE DDC STEP-DOWN  
 μMODULE REGULATOR WITH POWER SYSTEM MANAGEMENT  
**LTM4678AEV / LTM4630EV**  
**DEMO CIRCUIT 2106B-B**  
 DATE: Thursday, June 04, 2015



# DEMO MANUAL DC2106B-B

## SCHEMATIC DIAGRAM

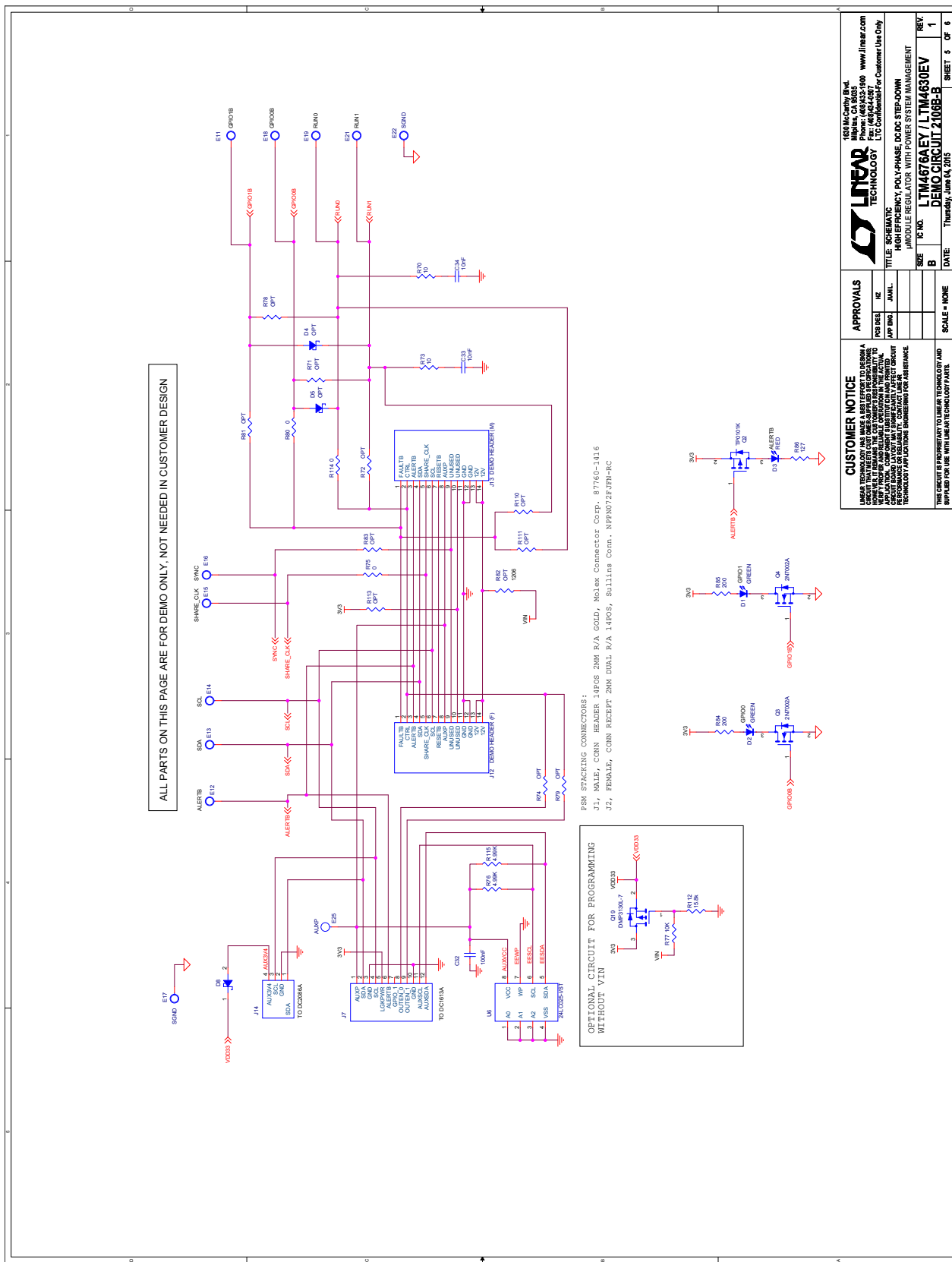

ALL PARTS ON THIS PAGE ARE FOR DEMO ONLY, NOT NEEDED IN CUSTOMER DESIGN

PSN STACKING CONNECTORS:  
 J1, MALE, CONN HEADER 14POS 2MM R/A GOLD, Molex Connector Corp. 87760-1416  
 J2, FEMALE, CONN RECEPT 2MM DUAL R/A 14POS, Sullins Conn. NFFN072FFEN-RC

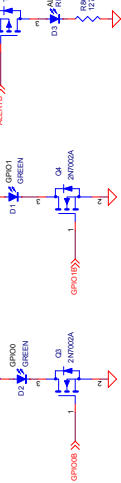
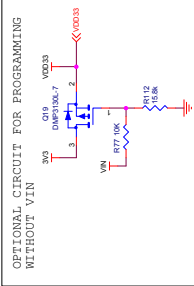

<b>CUSTOMER NOTICE</b>		<b>APPROVALS</b>		LINAIR TECHNOLOGY AND MAKES A BEST EFFORT TO DESIGN A DEMO CIRCUIT FOR THE LTM4676A-EY/LTM4630EV. CUSTOMERS WILL REMAIN RESPONSIBLE FOR THE DESIGN OF THE LTM4676A-EY/LTM4630EV APPLICATION. CUSTOMERS WILL BE RESPONSIBLE FOR THE PERFORMANCE OF THE LTM4676A-EY/LTM4630EV IN THEIR APPLICATIONS. CONTACT US FOR TECHNICAL SUPPORT INFORMATION.
DESIGNED BY:	R. HAY	APPROVED BY:	R. HAY	
DATE:	2012-03-22	SCALE:	NONE	

  

REV	DATE	BY	DESCRIPTION
1	2012-03-22	R. HAY	INITIAL RELEASE
2	2012-03-22	R. HAY	DESIGN CHANGES

LINAIR TECHNOLOGY, INC. 1101 GULL AVENUE, SUITE 100 MILPITAS, CA 95035 PHONE: 650-943-1500 WWW.LINAIR.COM	<b>LINAIR TECHNOLOGY</b> HIGH EFFICIENCY, POLY-PHASE, DODIC STEP-DOWN μMODULE REGULATOR WITH POWER SYSTEM MANAGEMENT <b>LTM4676A-EY / LTM4630EV</b> DEMO CIRCUIT 2106B-B
---	--

**SCHEMATIC DIAGRAM**

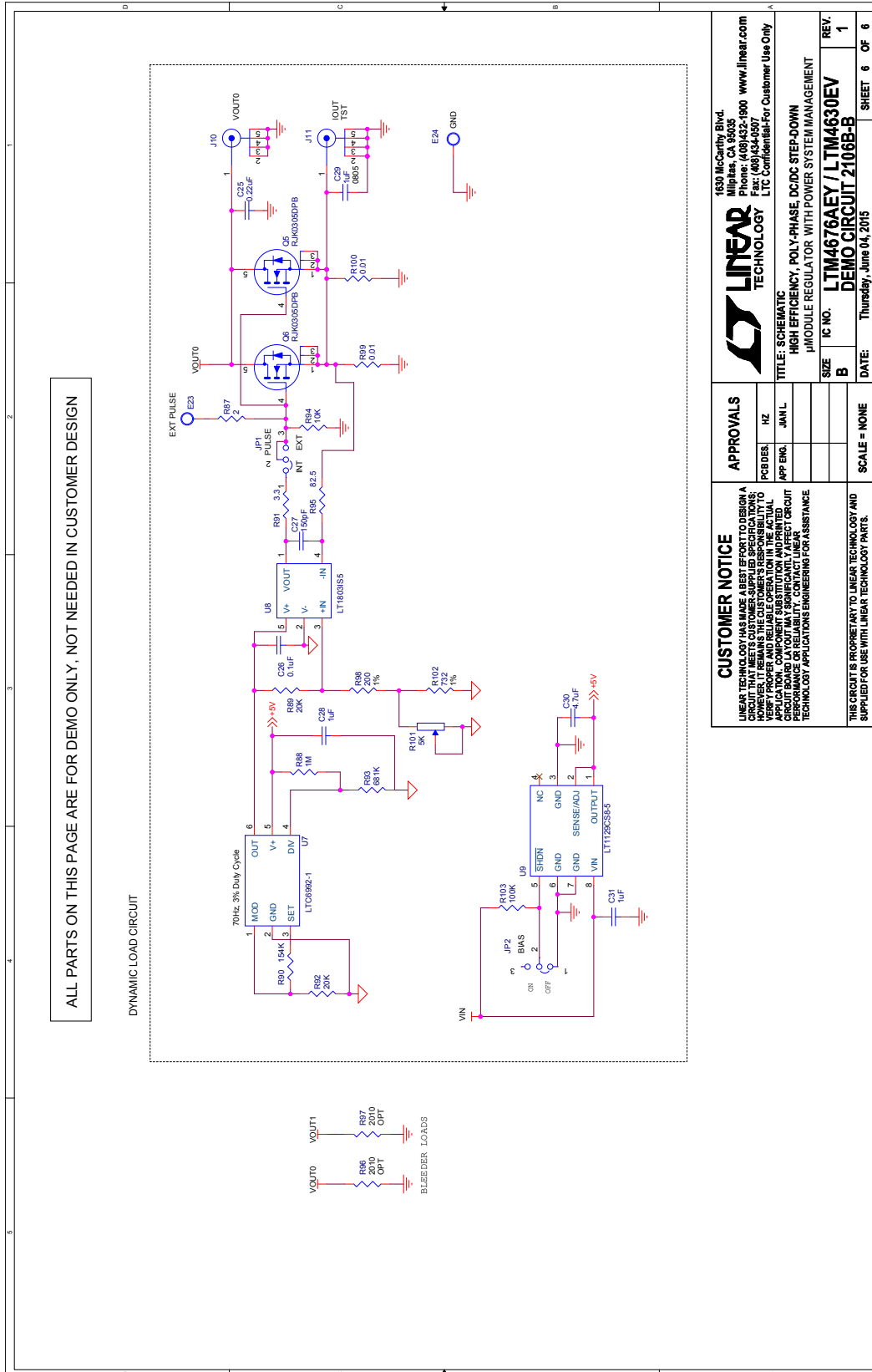

<b>LINEAR TECHNOLOGY</b>		1630 McCarthy Blvd. Milpitas, CA 95035 Phone: (408)432-1900 www.linear.com Fax: (408)434-0907 LTC Confidential-For Customer Use Only	
<b>CUSTOMER NOTICE</b>		TITLE: SCHEMATIC HIGH EFFICIENCY, POLY-PHASE, DC/DC STEP-DOWN μMODULE REGULATOR WITH POWER SYSTEM MANAGEMENT	
LINEAR TECHNOLOGY HAS MADE A BEST EFFORT TO DESIGN A CIRCUIT THAT MEETS CUSTOMER SPECIFIED REQUIREMENTS AND DOES NOT VIOLATE ANY APPLICABLE LAWS. CUSTOMER AGREES TO USE THE CIRCUIT AT HIS OWN RISK AND TO VERIFY PROPER AND RELIABLE OPERATION IN THE ACTUAL APPLICATION. COMPONENT SUBSTITUTION AND PRINTED CIRCUIT BOARD MANUFACTURING VARIATIONS MAY AFFECT CIRCUIT PERFORMANCE OR RELIABILITY. CONTACT LINEAR TECHNOLOGY APPLICATIONS ENGINEERING FOR ASSISTANCE.		SIZE: IC NO. LTM4676AEY / LTM4630EV REV. 1	
THIS CIRCUIT IS PROPRIETARY TO LINEAR TECHNOLOGY AND SUPPLIED FOR USE WITH LINEAR TECHNOLOGY PARTS.		DATE: Thursday, June 04, 2015 SHEET 6 OF 6	

Figure 7. Circuit Schematic

# DEMO MANUAL DC2106B-B

---

## DEMONSTRATION BOARD IMPORTANT NOTICE

Linear Technology Corporation (LTC) provides the enclosed product(s) under the following **AS IS** conditions:

This demonstration board (DEMO BOARD) kit being sold or provided by Linear Technology is intended for use for **ENGINEERING DEVELOPMENT OR EVALUATION PURPOSES ONLY** and is not provided by LTC for commercial use. As such, the DEMO BOARD herein may not be complete in terms of required design-, marketing-, and/or manufacturing-related protective considerations, including but not limited to product safety measures typically found in finished commercial goods. As a prototype, this product does not fall within the scope of the European Union directive on electromagnetic compatibility and therefore may or may not meet the technical requirements of the directive, or other regulations.

If this evaluation kit does not meet the specifications recited in the DEMO BOARD manual the kit may be returned within 30 days from the date of delivery for a full refund. **THE FOREGOING WARRANTY IS THE EXCLUSIVE WARRANTY MADE BY THE SELLER TO BUYER AND IS IN LIEU OF ALL OTHER WARRANTIES, EXPRESSED, IMPLIED, OR STATUTORY, INCLUDING ANY WARRANTY OF MERCHANTABILITY OR FITNESS FOR ANY PARTICULAR PURPOSE. EXCEPT TO THE EXTENT OF THIS INDEMNITY, NEITHER PARTY SHALL BE LIABLE TO THE OTHER FOR ANY INDIRECT, SPECIAL, INCIDENTAL, OR CONSEQUENTIAL DAMAGES.**

The user assumes all responsibility and liability for proper and safe handling of the goods. Further, the user releases LTC from all claims arising from the handling or use of the goods. Due to the open construction of the product, it is the user's responsibility to take any and all appropriate precautions with regard to electrostatic discharge. Also be aware that the products herein may not be regulatory compliant or agency certified (FCC, UL, CE, etc.).

No License is granted under any patent right or other intellectual property whatsoever. **LTC assumes no liability for applications assistance, customer product design, software performance, or infringement of patents or any other intellectual property rights of any kind.**

LTC currently services a variety of customers for products around the world, and therefore this transaction **is not exclusive**.

**Please read the DEMO BOARD manual prior to handling the product.** Persons handling this product must have electronics training and observe good laboratory practice standards. **Common sense is encouraged.**

This notice contains important safety information about temperatures and voltages. For further safety concerns, please contact a LTC application engineer.

Mailing Address:

Linear Technology  
1630 McCarthy Blvd.  
Milpitas, CA 95035

Copyright © 2004, Linear Technology Corporation

# Mouser Electronics

Authorized Distributor

Click to View Pricing, Inventory, Delivery & Lifecycle Information:

[Analog Devices Inc.:](#)

[DC2106B-B](#)