

1. Features

- $V_{DS}=20V, R_{DS(on)}=45m\Omega(\text{typ.})@V_{GS}=4.5V, I_D=3.0A$
- $V_{DS}=20V, R_{DS(on)}=55m\Omega(\text{typ.})@V_{GS}=2.5V, I_D=2.0A$

2. Symbol

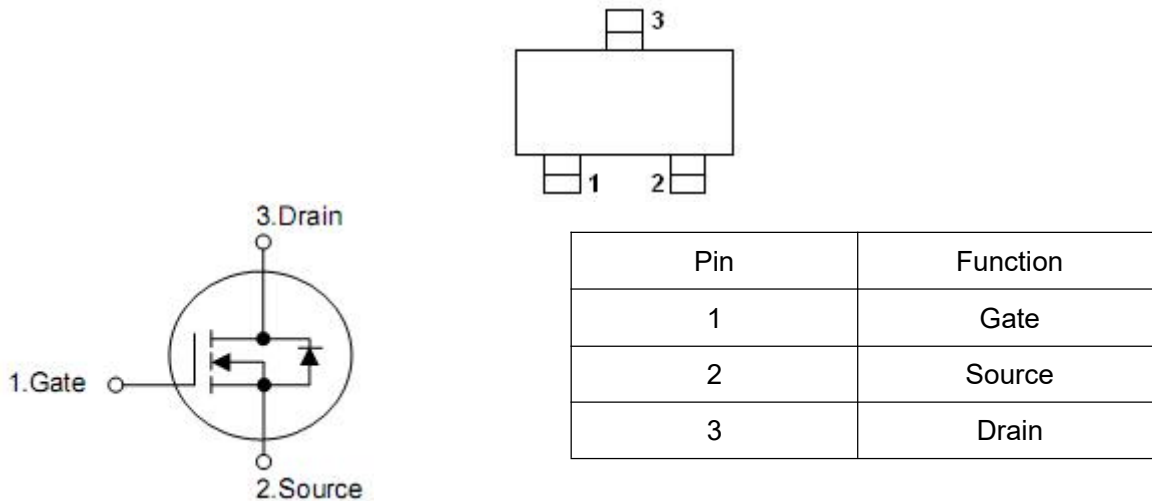

3. Absolute maximum ratings

Parameter	Symbol	Rating	Units
Drain-source voltage	V_{DS}	20	V
Gate-source voltage	V_{GS}	± 8	V
Drain current continuous ($T_J=150\text{ }^\circ\text{C}$)	I_D	3.0	A
Pulsed drain current ^a			
Continuous source current (diode conduction)	I_S	1.0	
Power dissipation	P_D	1.0	W
Junction and storage temperature range	T_J, T_{STG}	-55 to 150	$^\circ\text{C}$

Parameter	Symbol	Rating	Units
Thermal Resistance from Junction to Ambient($t \leq 5s$)	R_{thJA}	156	$^\circ\text{C/W}$

4. Electrical characteristics

 (T_A=25°C, unless otherwise noted)

Parameter	Symbol	Test Conditions	Min	Typ	Max	Units
Drain-source breakdown voltage	V _{(BR)DSS}	V _{GS} =0V, I _D =250μA	20	-	-	V
Gate threshold voltage	V _{GS(th)}	V _{DS} =V _{GS} , I _D =250μA	0.5	-	1.0	V
Gate- body leakage	I _{GSS}	V _{GS} =±8V, V _{DS} =0V	-	-	±100	nA
Zero gate voltage drain current	I _{DSS}	V _{DS} =16V, V _{GS} =0V	-	-	1	uA
Static drain-source on-resistance ^a	R _{DS(on)}	V _{GS} =4.5V, I _D =3.0A	-	45	50	mΩ
		V _{GS} =2.5V, I _D =2.0A	-	55	65	
Forward transconductance ^a	g _{fs}	V _{DS} =5V, I _D =3.0A	-	8	-	S
Diode forward voltage	V _{SD}	V _{GS} =0V, I _S =1.0A	-	-	1.3	V
Total gate charge ^b	Q _g	V _{DS} =10V, V _{GS} =4.5V I _D =3.0A	-	5.4	-	nC
Gate-source charge ^b	Q _{gs}		-	1.1	-	
Gate-drain charge ^b	Q _{gd}		-	0.7	-	
Input capacitance ^b	C _{iss}	V _{DS} =10V, V _{GS} =0V, f=1MHz	-	300	-	pF
Output capacitance ^b	C _{oss}		-	120	-	
Reverse transfer capacitance ^b	C _{rss}		-	85	-	
Turn-on delay time ^b	t _{d(on)}	V _{DD} =10V, I _D =3.0A, R _G =6Ω, V _{GEN} =4.5V	-	12	-	ns
Rise time ^b	t _r		-	84	-	
Turn-off delay time ^b	t _{d(off)}		-	43	-	
Fall time ^b	t _f		-	18	-	

Notes :

a. Pulse Test : Pulse Width < 300μs, Duty Cycle ≤2%.

b. Guaranteed by design, not subject to production testing.

5. Test circuits and waveforms

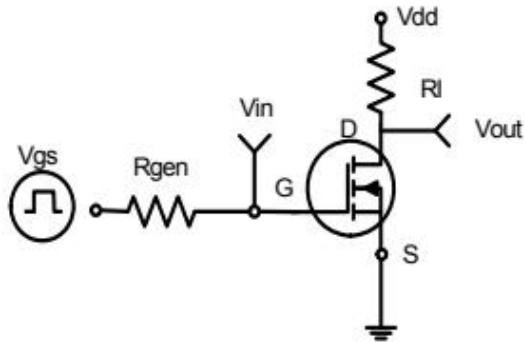

Figure 1:Switching Test Circuit

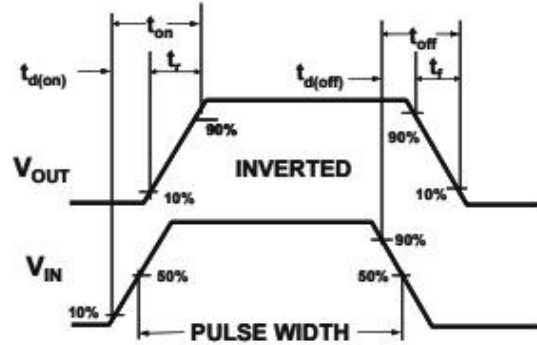

Figure 2:Switching Waveforms

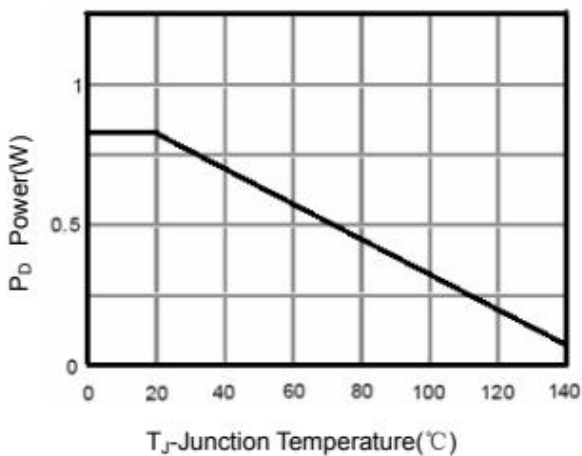

Figure 3 Power Dissipation

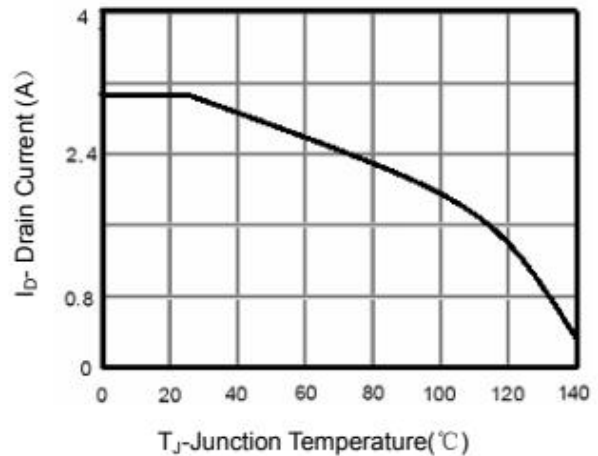

Figure 4 Drain Current

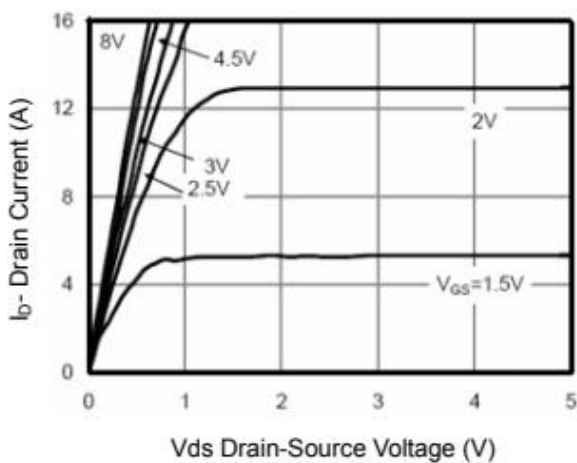

Figure 5 Output Characteristics

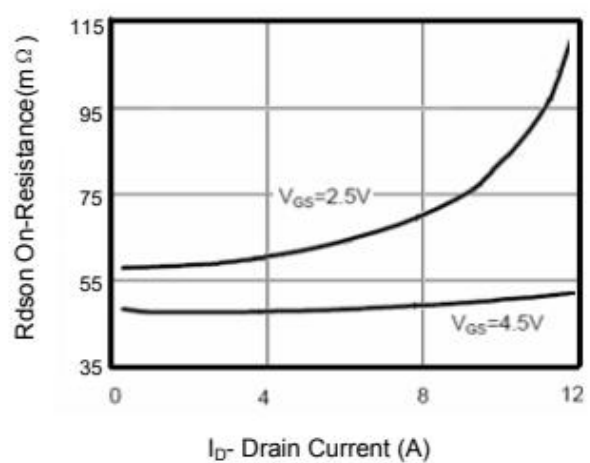

Figure 6 Drain-Source On-Resistance

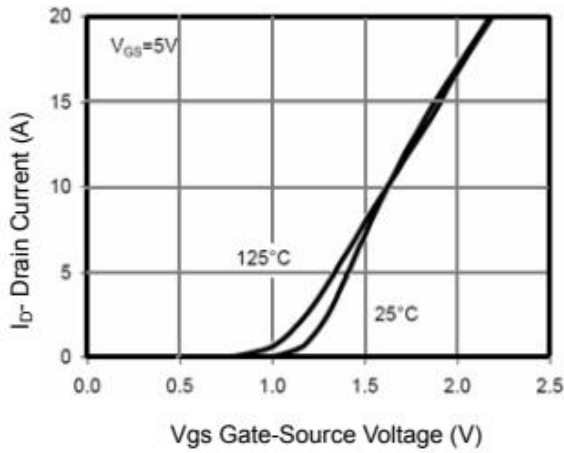

Figure 7 Transfer Characteristics

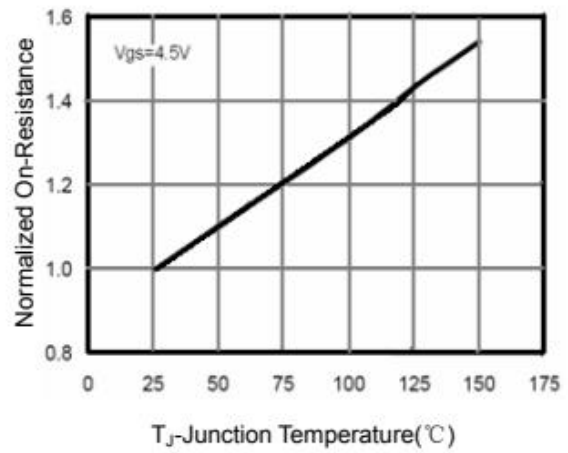

Figure 8 Drain-Source On-Resistance

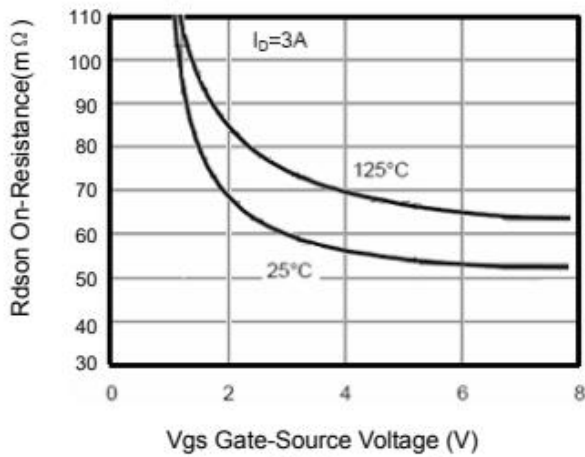

Figure 9 Rds(on) vs Vgs

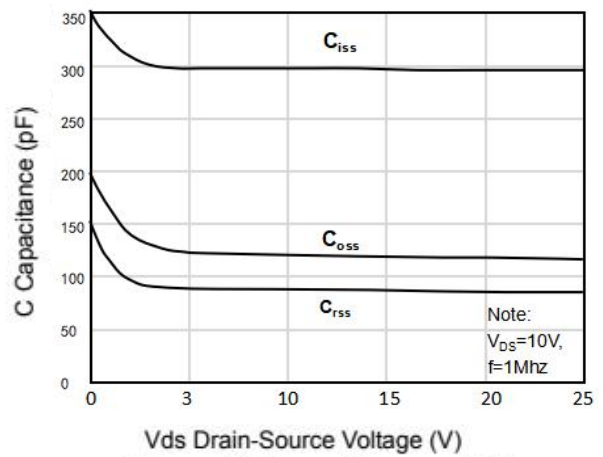

Figure 10 Capacitance vs Vds

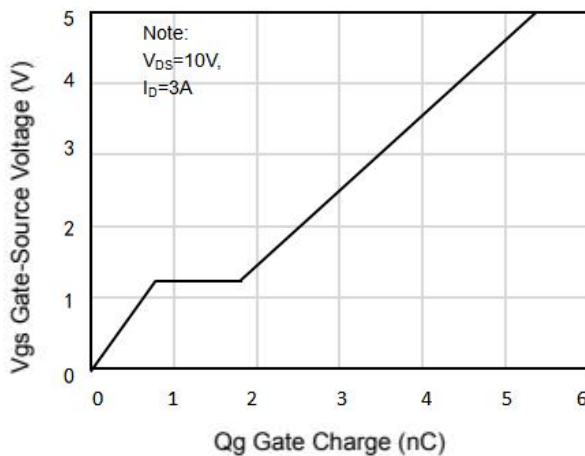

Figure 11 Gate Charge

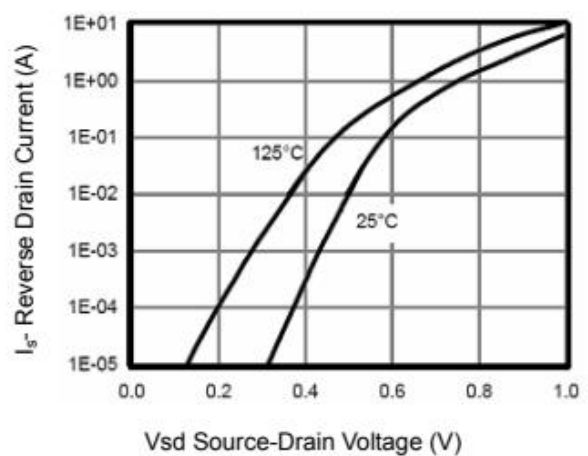

Figure 12 Source- Drain Diode Forward

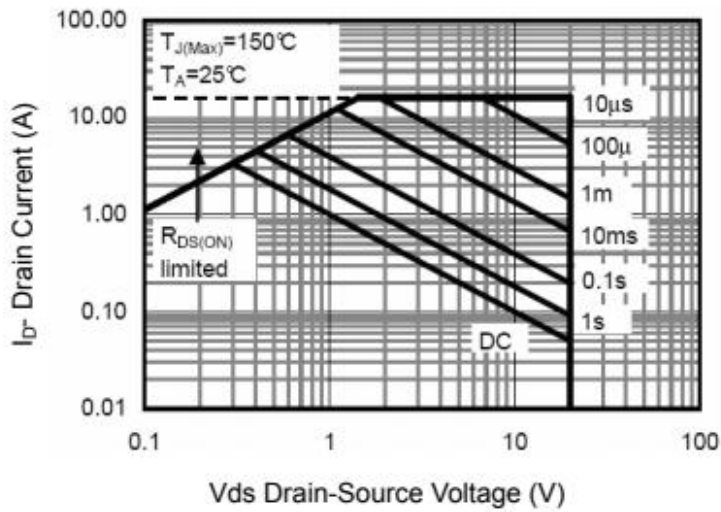

Figure 13 Safe Operation Area

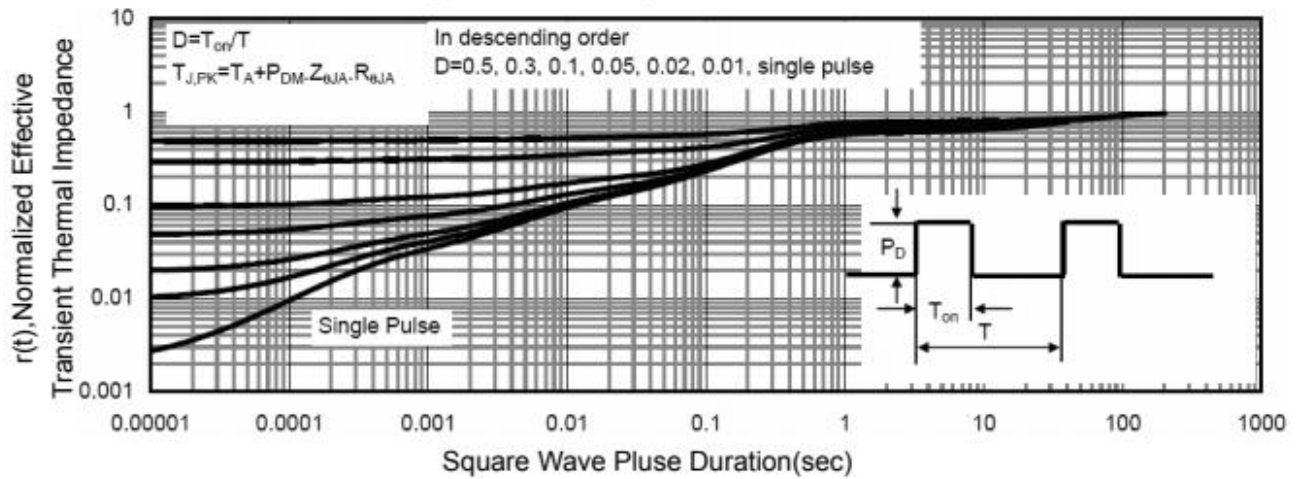

Figure 14 Normalized Maximum Transient Thermal Impedance