

THIS DOCUMENT IS THE PROPERTY OF
KEYSTONE ELECTRONICS CORP. AND
SHALL NOT BE REPRODUCED, DISTRIBUTED
OR USED AS A BASIS FOR MANUFACTURE
WITHOUT PRIOR WRITTEN PERMISSION
FROM KEYSTONE ELECTRONICS CORP.

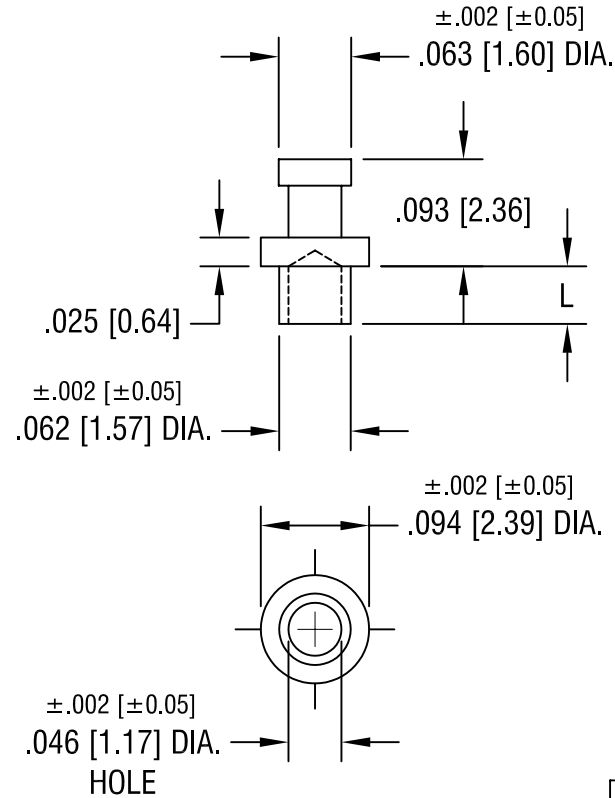

PART NO.	'L' DIM.
1508-1	.053 [1.34]
1508-2	.084 [2.13]
1508-3	.115 [2.92]
1508-4	.147 [3.73]

KEYSTONE ELECTRONICS CORP.

ASTORIA, N.Y. 11105-2017

PART NAME

SOLDER TERMINAL, SINGLE TURRET

MATERIAL

BRASS

FINISH

TIN PLATE

DRN BY

BOONE

DATE

5.24.02

APP'D

LN

SCALE

6X

2.8.08 CHANGE AS PER ECN 08-074

A

TOLERANCES

INCH [MM]

DECIMAL ±.005 [±0.15]

ANGULAR ± 1°

UNLESS OTHERWISE SPECIFIED

CODE

C

DWG NO.

1508-

DATE

DESCRIPTION

REV.

Mouser Electronics

Authorized Distributor

Click to View Pricing, Inventory, Delivery & Lifecycle Information:

[Keystone Electronics:](#)

[1508-4](#)