

### FEATURES

- Passive: no dc bias required
- Conversion loss: 8 dB (typical)
- Input IP3: 20 dBm (typical)
- LO to RF isolation: 47 dB (typical)
- IF frequency range: dc to 3.5 GHz
- RoHS compliant, 24-terminal, 4 mm × 4 mm LCC package

### APPLICATIONS

- Microwave and very small aperture terminal radios
- Test equipment
- Point to point radios
- Military electronic warfare; electronic countermeasure; and command, control, communications, and intelligence

### GENERAL DESCRIPTION

The HMC525ALC4 is a compact gallium arsenide (GaAs), monolithic microwave integrated circuit (MMIC), in phase quadrature (I/Q) mixer in a 24-terminal, RoHS compliant, ceramic leadless chip carrier (LCC) package. The device can be used as either an image reject mixer or a single sideband (SSB) upconverter. The mixer uses two standard double balanced

### FUNCTIONAL BLOCK DIAGRAM

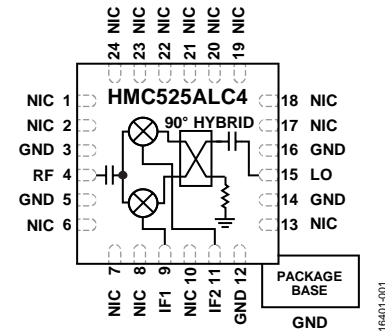

Figure 1.

mixer cells and a 90° hybrid fabricated in a GaAs, metal semiconductor field effect transistor (MESFET) process. The HMC525ALC4 is a much smaller alternative to a hybrid style image reject mixer and a SSB upconverter assembly. The HMC525ALC4 eliminates the need for wire bonding, allowing the use of surface-mount manufacturing techniques.

**TABLE OF CONTENTS**

Features .....	1	Upconverter Performance .....	12
Applications .....	1	Phase and Amplitude Balance—Downconverter.....	18
Functional Block Diagram .....	1	Isolation and Return Loss .....	20
General Description .....	1	IF Bandwidth—Downconverter.....	22
Revision History .....	2	Spurious and Harmonics Performance .....	24
Specifications.....	3	Theory of Operation .....	25
Absolute Maximum Ratings.....	4	Applications Information .....	26
Thermal Resistance .....	4	Typical Application Circuit.....	26
ESD Caution.....	4	Evaluation PCB Information .....	26
Pin Configuration and Function Descriptions.....	5	Soldering Information and Recommended Land Pattern ....	27
Interface Schematics.....	5	Outline Dimensions .....	28
Typical Performance Characteristics .....	6	Ordering Guide .....	28
Downconverter Performance.....	6		

**REVISION HISTORY**

**5/2018—Rev. 0 to Rev. A**

Changes to Typical Application Circuit Section..... 26

**4/2018—Revision 0: Initial Version**

## SPECIFICATIONS

LO = 15 dBm, intermediate frequency (IF) = 100 MHz, RF = -10 dBm,  $T_A = 25^\circ\text{C}$ , unless otherwise noted. All measurements were made as downconverter with lower sideband selected (high-side LO) and an external  $90^\circ$  IF hybrid at the IF ports, unless otherwise noted.

Table 1.

Parameter	Test Conditions/Comments	Min	Typ	Max	Unit
<b>FREQUENCY RANGE</b>					
RF		4		8.5	GHz
LO Input		4		8.5	GHz
IF		DC		3.5	GHz
<b>LO AMPLITUDE</b>					
		13	15	17	dBm
<b>4 GHz to 8.5 GHz PERFORMANCE</b>					
Downconverter	Taken as image reject mixer				
Conversion Loss			8	11	dB
Noise Figure			8		dB
Input Third-Order Intercept (IP3)		17	20		dBm
Input Power for 1dB Compression (P1dB)			13		dBm
Image Rejection		23	30		dBc
Upconverter	Taken as SSB upconverter mixer				
Conversion Loss			7.5		dB
Input IP3			20		dBm
Input P1dB			8.5		dBm
Sideband Rejection			30		dBc
Isolation	Taken without external $90^\circ$ IF hybrid				
LO to RF		35	47		dB
LO to IF			23		dB
RF to IF			42		dB
Balance	Taken without external $90^\circ$ IF hybrid				
Phase			2		Degree
Amplitude			0.05		dB
<b>4.5 GHz to 6 GHz PERFORMANCE</b>					
Downconverter	Taken as image reject mixer				
Conversion Loss			7.5	9.5	dB
Noise Figure			7.5		dB
Input IP3		17	21		dBm
Input P1dB			12		dBm
Image Rejection		25	30		dBc
Upconverter	Taken as SSB upconverter mixer				
Conversion Loss			7		dB
Input IP3			22		dBm
Input P1dB			10.5		dBm
Sideband Rejection			30		dBc
Isolation	Taken without external $90^\circ$ IF hybrid				
LO to RF		35	45		dB
LO to IF			21		dB
RF to IF			40		dB
Balance	Taken without external $90^\circ$ IF hybrid				
Phase			3		Degree
Amplitude			0.15		dB

## ABSOLUTE MAXIMUM RATINGS

Table 2.

Parameter	Rating
RF Input Power	20 dBm
LO Input Power	25 dBm
IF Input Power	20 dBm
IF Source and Sink Current	2 mA
Reflow Temperature	260°C
Maximum Junction Temperature (T <sub>J</sub> )	175°C
Lifetime at Maximum (T <sub>J</sub> )	>1 × 10 <sup>6</sup> hours
Moisture Sensitivity Level (MSL) <sup>1</sup>	3
Continuous Power Dissipation, P <sub>DISS</sub> (T <sub>A</sub> = 85°C, Derate 6.22 mW/°C Above 85°C) <sup>2</sup>	560 mW
Operating Temperature Range	–40°C to +85°C
Storage Temperature Range	–65°C to +150°C
Lead Temperature Range	–65°C to +150°C
Electrostatic Discharge (ESD) Sensitivity	
Human Body Model (HBM)	250 V
Field Induced Charged Device Model (FICDM)	500 V

<sup>1</sup> Based on IPC/JEDEC J-STD-20 MSL Classifications.

<sup>2</sup> P<sub>DISS</sub> is a theoretical number calculated by (T<sub>J</sub> – 85°C)/θ<sub>JC</sub>.

Stresses at or above those listed under Absolute Maximum Ratings may cause permanent damage to the product. This is a stress rating only; functional operation of the product at these or any other conditions above those indicated in the operational section of this specification is not implied. Operation beyond the maximum operating conditions for extended periods may affect product reliability.

## THERMAL RESISTANCE

Thermal performance is directly linked to printed circuit board (PCB) design and operating environment. Careful attention to PCB thermal design is required.

θ<sub>JA</sub> is the natural convection junction to ambient thermal resistance measured in a one cubic foot sealed enclosure. θ<sub>JC</sub> is the junction to case thermal resistance.

Table 3. Thermal Resistance

Package Type	θ <sub>JA</sub>	θ <sub>JC</sub>	Unit
E-24-1 <sup>1</sup>	120	161	°C/W

<sup>1</sup> See JEDEC standard JESD51-2 for additional information on optimizing the thermal impedance (PCB with 3 × 3 vias).

## ESD CAUTION



**ESD (electrostatic discharge) sensitive device.** Charged devices and circuit boards can discharge without detection. Although this product features patented or proprietary protection circuitry, damage may occur on devices subjected to high energy ESD. Therefore, proper ESD precautions should be taken to avoid performance degradation or loss of functionality.

# PIN CONFIGURATION AND FUNCTION DESCRIPTIONS

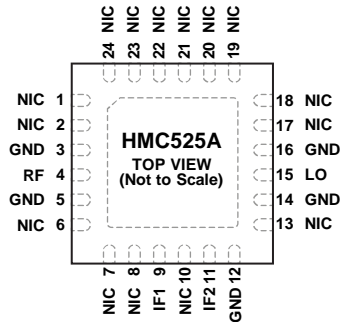

NOTES  
 1. NIC = NOT INTERNALLY CONNECTED.  
 2. EXPOSED PAD. THE EXPOSED PAD MUST BE CONNECTED TO THE GND PIN.

16401-002

Figure 2. Pin Configuration

Table 4. Pin Function Descriptions

Pin No.	Mnemonic	Description
1, 2, 6 to 8, 10, 13, 17 to 24	NIC	Not Internally Connected.
3, 5, 12, 14, 16	GND	Ground. See Figure 7 for the GND interface schematic.
4	RF	RF Port. This pin is ac-coupled internally and matches to 50 Ω from 4 GHz to 8.5 GHz. See Figure 3 for the RF interface schematic.
9, 11	IF1, IF2	First and Second Quadrature Intermediate Frequency Input Pins. These pins are dc-coupled. For applications that do not require operation to dc, use an off-chip dc blocking capacitor. For applications that require operation to dc, these pins must not source or sink more than 2 mA of current because the device may not function or possible device failure may result. See Figure 5 and Figure 6 for the IF1 and IF2 interface schematics.
15	LO	Local Oscillator Port. This pin is ac-coupled and matches to 50 Ω. See Figure 4 for the LO interface schematic.
	EPAD	Exposed Pad. The exposed pad must be connected to the GND pin.

## INTERFACE SCHEMATICS

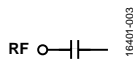

Figure 3. RF Interface Schematic

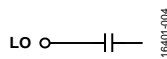

Figure 4. LO Interface Schematic

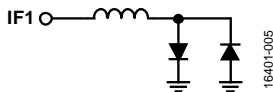

Figure 5. IF1 Interface Schematic

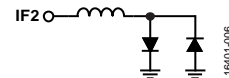

Figure 6. IF2 Interface Schematic



Figure 7. GND Interface Schematic

# TYPICAL PERFORMANCE CHARACTERISTICS

## DOWNCONVERTER PERFORMANCE

IF = 100 MHz, Upper Side Band (Low-Side LO)

Data taken as image reject mixer with external 90° hybrid at the IF ports.

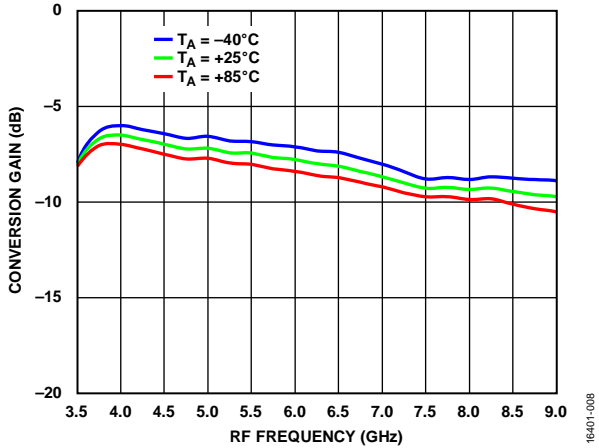

Figure 8. Conversion Gain vs. RF Frequency at Various Temperatures, LO = 15 dBm

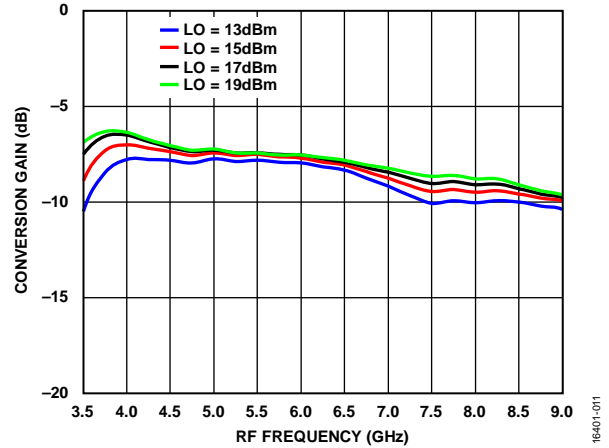

Figure 11. Conversion Gain vs. RF Frequency at Various LO Power Levels, TA = 25°C

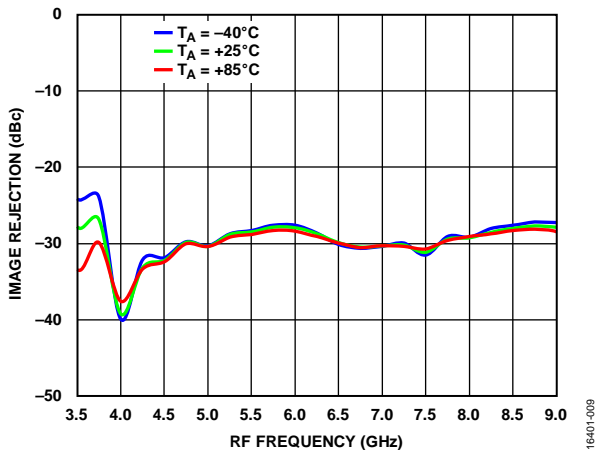

Figure 9. Image Rejection vs. RF Frequency at Various Temperatures, LO = 15 dBm

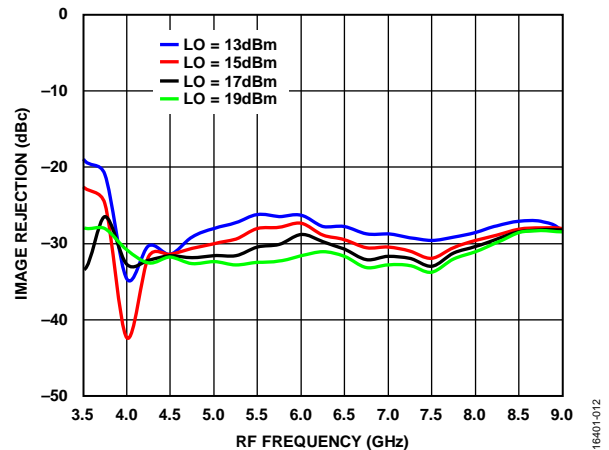

Figure 12. Image Rejection vs. RF Frequency at Various LO Power Levels, TA = 25°C

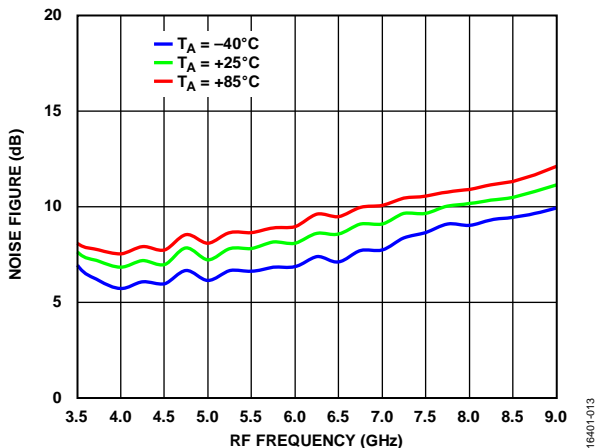

Figure 10. Noise Figure vs. RF Frequency at Various Temperatures, LO = 15 dBm

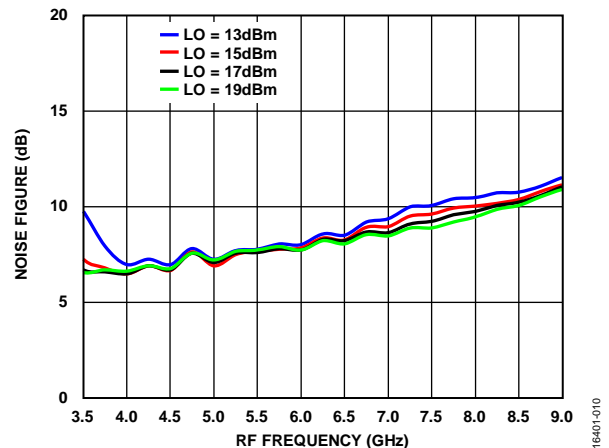

Figure 13. Noise Figure vs. RF Frequency at Various LO Power Levels, TA = 25°C

**IF = 100 MHz, Upper Side Band (Low-Side LO)**

Data taken as image reject mixer with external 90° hybrid at the IF ports.

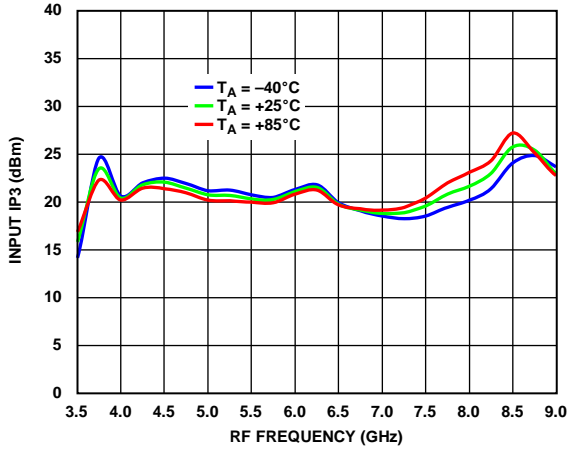

Figure 14. Input IP3 vs. RF Frequency at Various Temperatures, LO = 15 dBm

16401-014

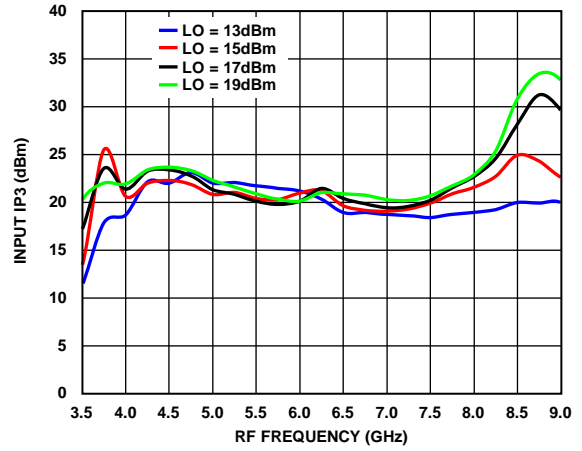

Figure 17. Input IP3 vs. RF Frequency at Various LO Power Levels, TA = 25°C

16401-017

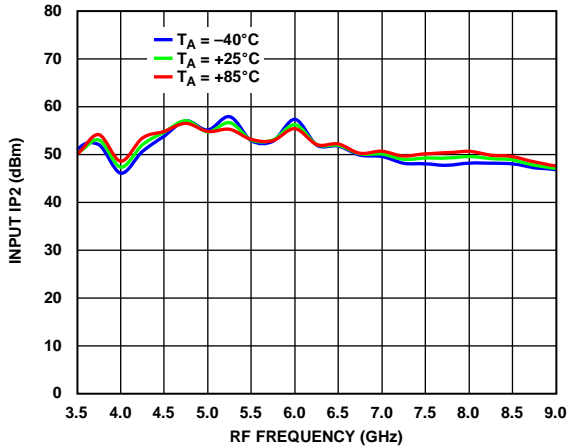

Figure 15. Input IP2 vs. RF Frequency at Various Temperatures, LO = 15 dBm

16401-015

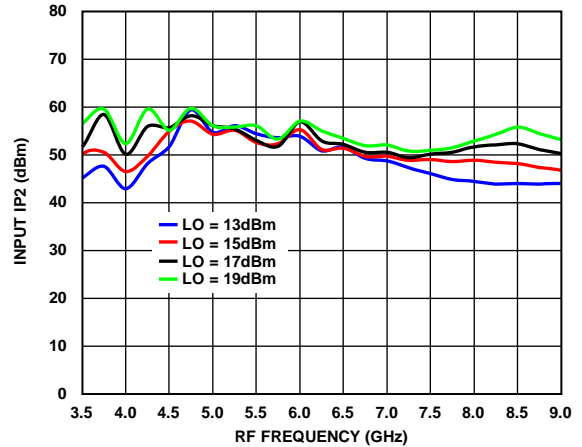

Figure 18. Input IP2 vs. RF Frequency at Various LO Power Levels, TA = 25°C

16401-018

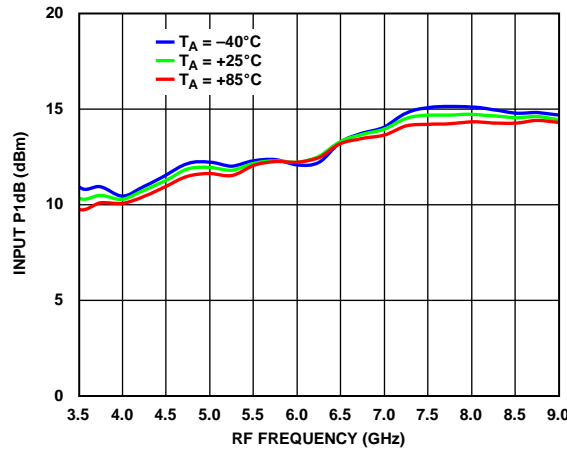

Figure 16. Input P1dB vs. RF Frequency at Various Temperatures, LO = 15 dBm

16401-019

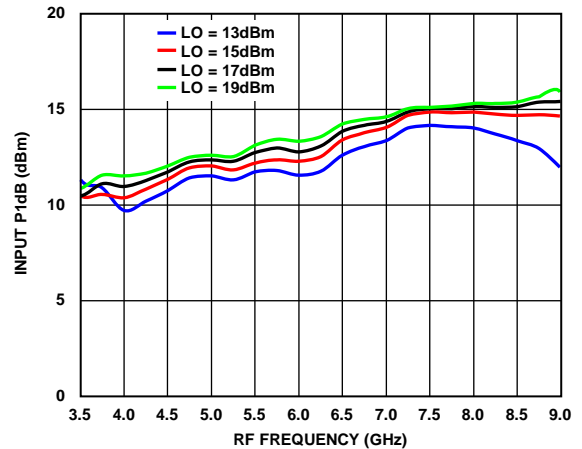

Figure 19. Input P1dB vs. RF Frequency at Various LO Power Levels, TA = 25°C

16401-016

## IF = 100 MHz, Lower Side Band (High-Side LO)

Data taken as image reject mixer with external 90° hybrid at the IF ports.

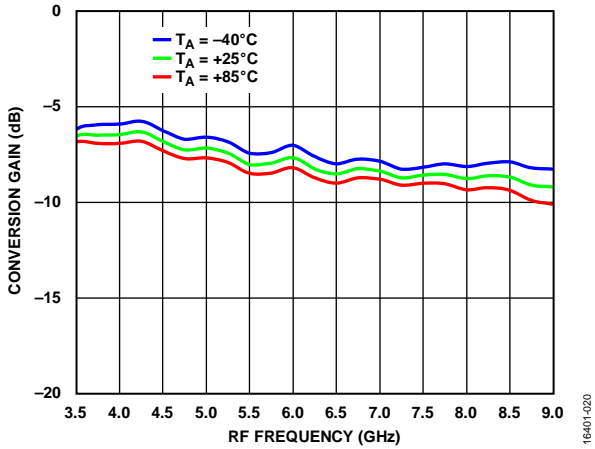

Figure 20. Conversion Gain vs. RF Frequency at Various Temperatures, LO = 15 dBm

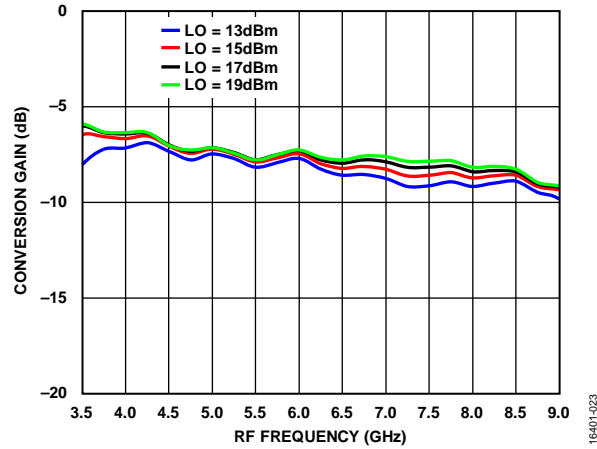

Figure 23. Conversion Gain vs. RF Frequency at Various LO Power Levels, TA = 25°C

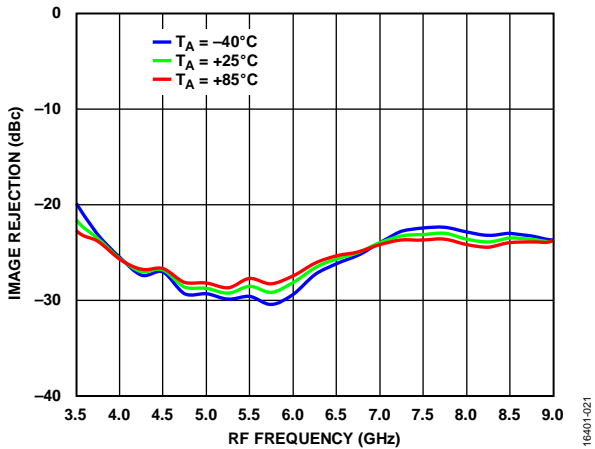

Figure 21. Image Rejection vs. RF Frequency at Various Temperatures, LO = 15 dBm

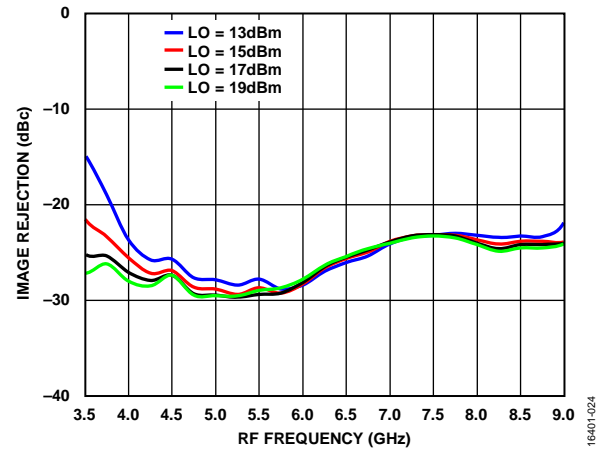

Figure 24. Image Rejection vs. RF Frequency at Various LO Power Levels, TA = 25°C

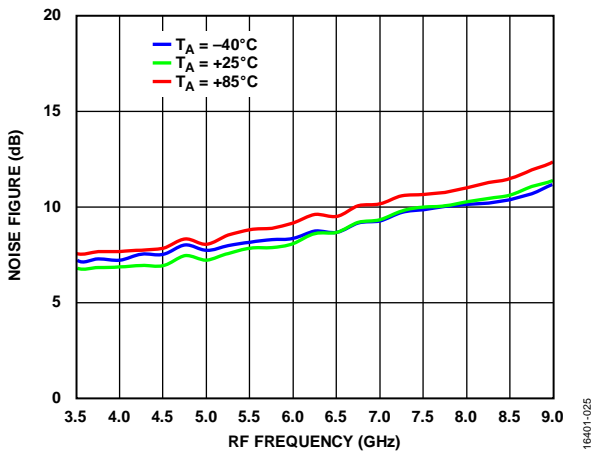

Figure 22. Noise Figure vs. RF Frequency at Various Temperatures, LO = 15 dBm

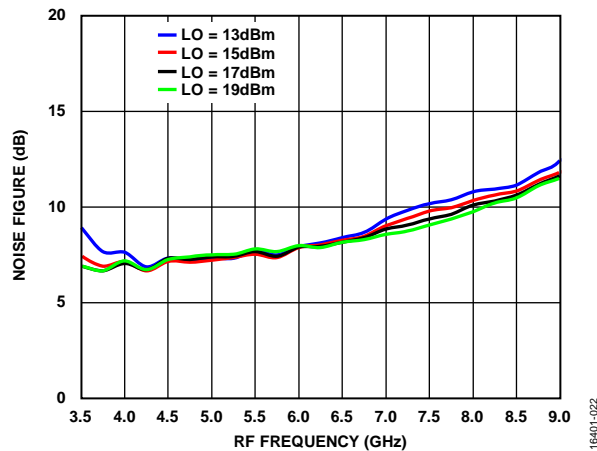

Figure 25. Noise Figure vs. RF Frequency at Various LO Power Levels, TA = 25°C



**IF = 100 MHz, Lower Side Band (High-Side LO)**

Data taken as image reject mixer with external 90° hybrid at the IF ports.

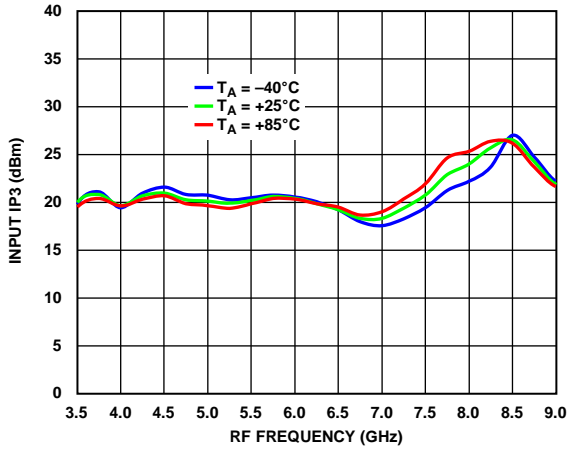

Figure 26. Input IP3 vs. RF Frequency at Various Temperatures, LO = 15 dBm

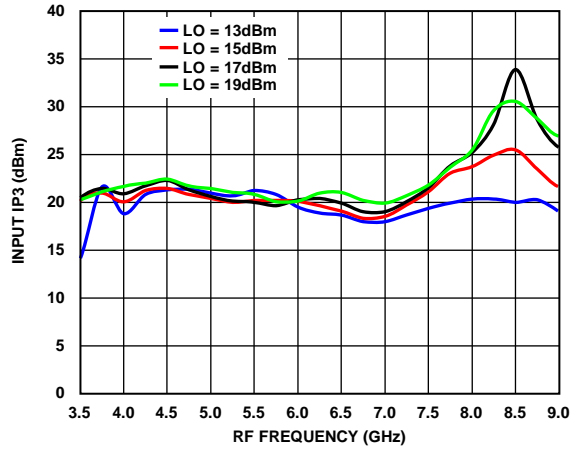

Figure 29. Input IP3 vs. RF Frequency at Various LO Power Levels, TA = 25°C

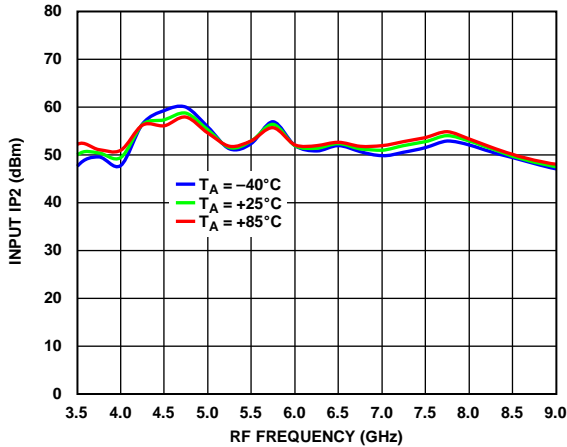

Figure 27. Input IP2 vs. RF Frequency at Various Temperatures, LO = 15 dBm

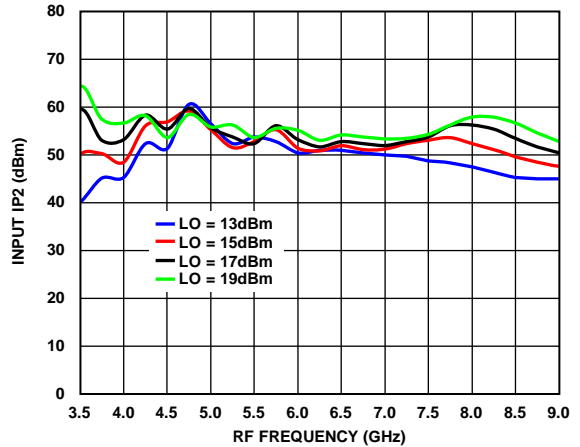

Figure 30. Input IP2 vs. RF Frequency at Various LO Power Levels, TA = 25°C

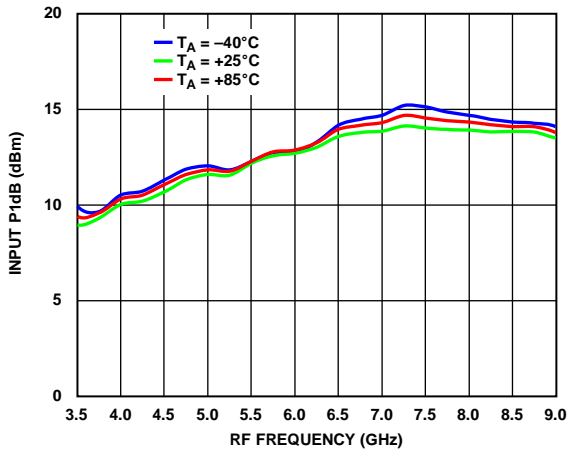

Figure 28. Input P1dB vs. RF Frequency at Various Temperatures, LO = 15 dBm

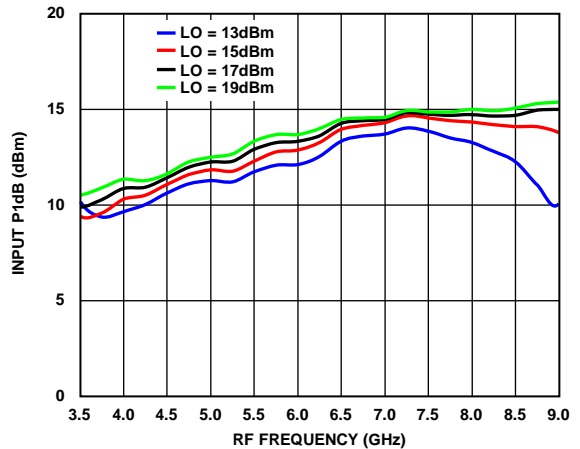

Figure 31. Input P1dB vs. RF Frequency at Various LO Power Levels, TA = 25°C

## IF = 2500 MHz, Upper Side Band (Low-Side LO)

Data taken as image reject mixer with external 90° hybrid at the IF ports.

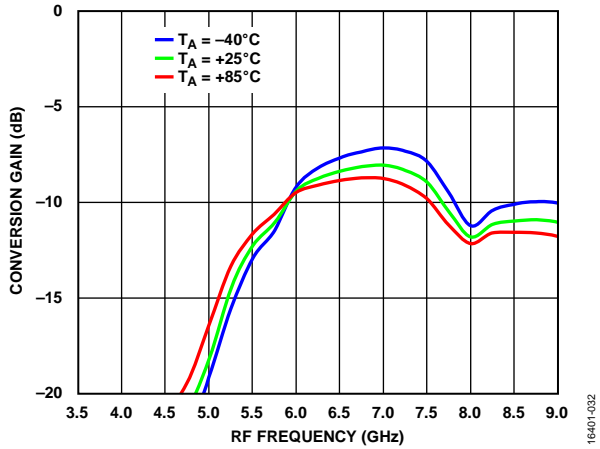

Figure 32. Conversion Gain vs. RF Frequency at Various Temperatures, LO = 15 dBm

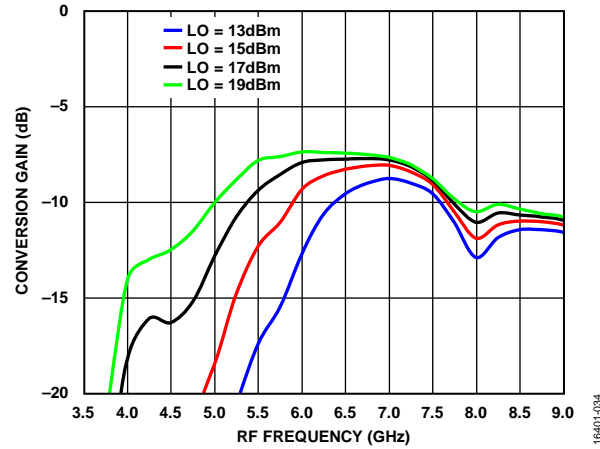

Figure 35. Conversion Gain vs. RF Frequency at Various LO Power Levels, TA = 25°C

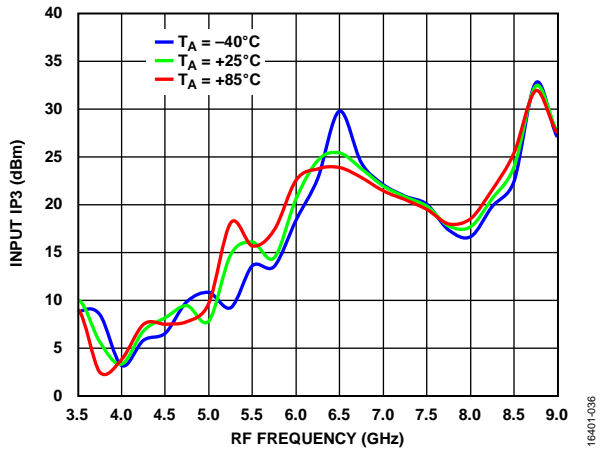

Figure 33. Input IP3 vs. RF Frequency at Various Temperatures, LO = 15 dBm

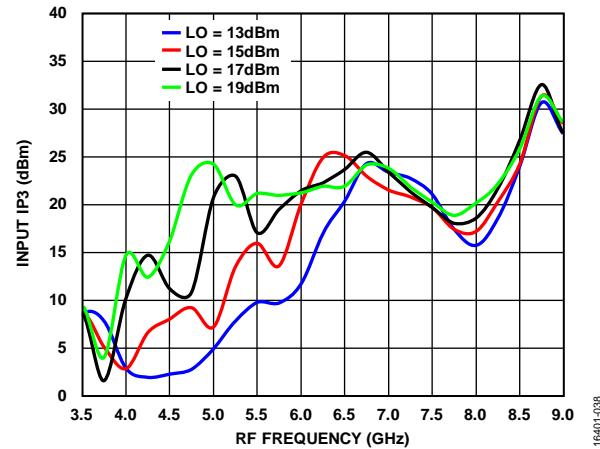

Figure 36. Input IP3 vs. RF Frequency at Various LO Power Levels, TA = 25°C

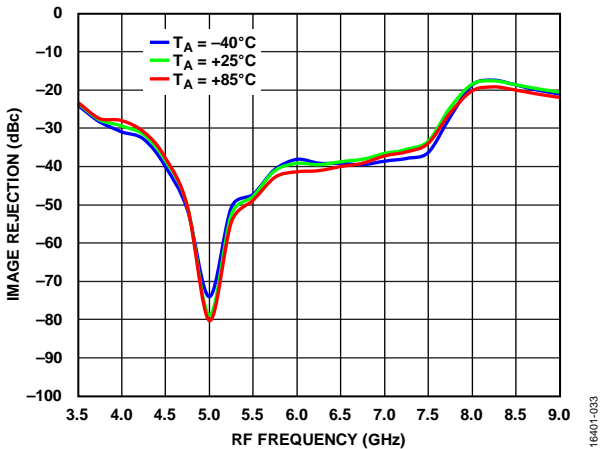

Figure 34. Image Rejection vs. RF Frequency at Various Temperatures, LO = 15 dBm

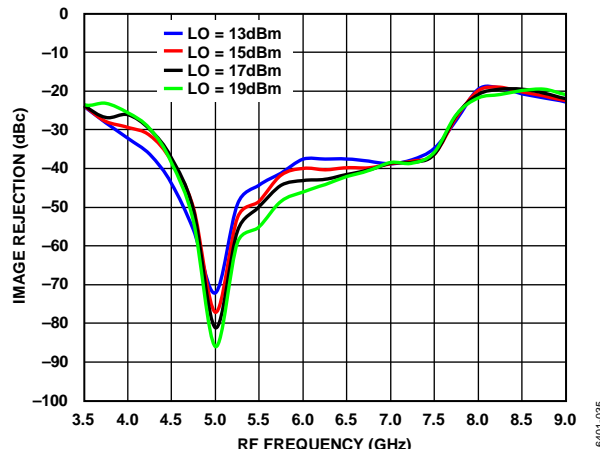

Figure 37. Image Rejection vs. RF Frequency at Various LO Power Levels, TA = 25°C

**IF = 2500 MHz, Lower Side Band (High-Side LO)**

Data taken as image-reject mixer with external 90° hybrid at the IF ports.

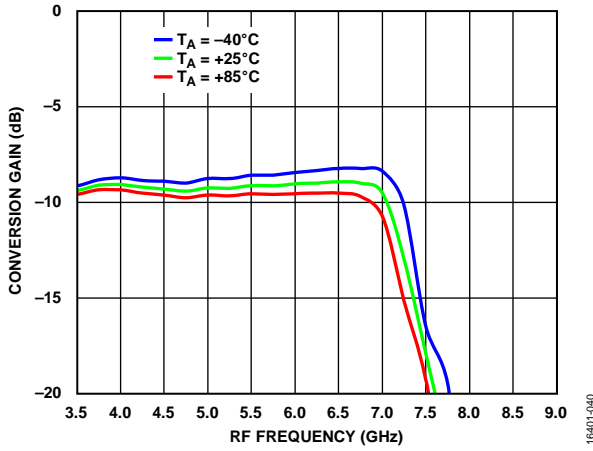

Figure 38. Conversion Gain vs. RF Frequency at Various Temperatures, LO = 15 dBm

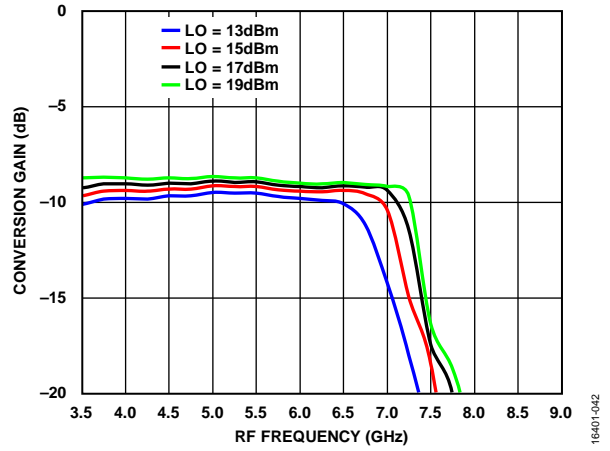

Figure 41. Conversion Gain vs. RF Frequency at Various LO Power Levels, TA = 25°C

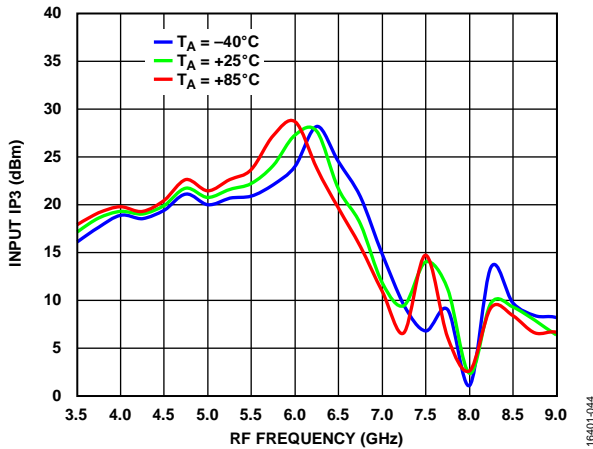

Figure 39. Input IP3 vs. RF Frequency at Various Temperatures, LO = 15 dBm

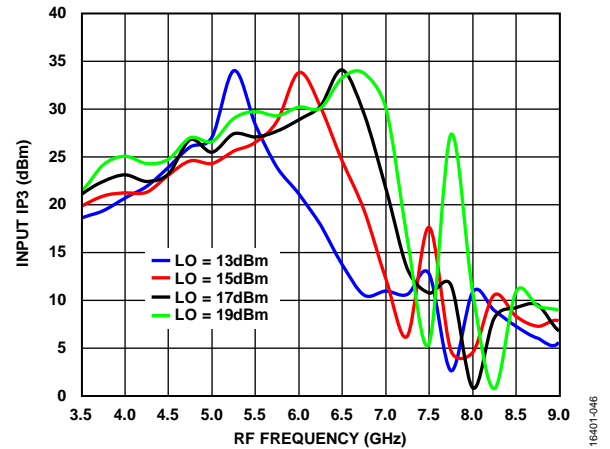

Figure 42. Input IP3 vs. RF Frequency Various LO Power Levels, TA = 25°C

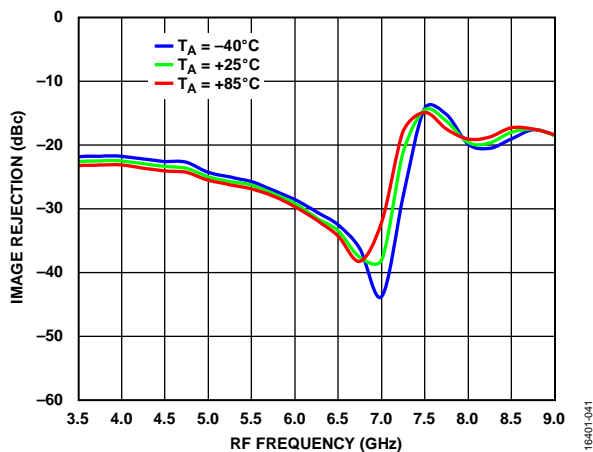

Figure 40. Image Rejection vs. RF Frequency at Various Temperatures, LO = 15 dBm

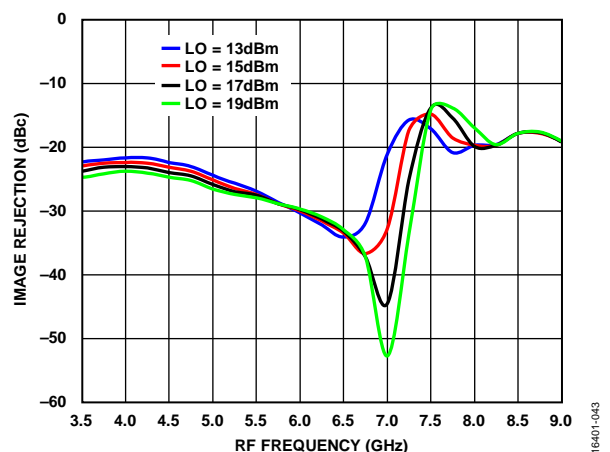

Figure 43. Image Rejection vs. RF Frequency at Various LO Power Levels, TA = 25°C

**UPCONVERTER PERFORMANCE**

**$IF_{IN} = 100$  MHz, Upper Side Band (Low-Side LO)**

Data taken as single sideband upconverter with external 90° hybrid at the IF ports.

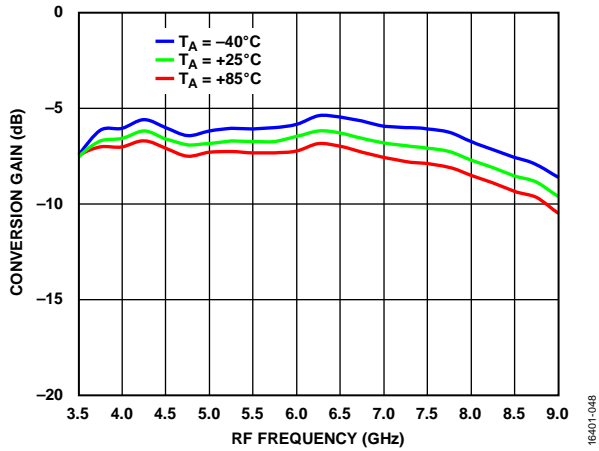

Figure 44. Conversion Gain vs. RF Frequency at Various Temperatures, LO = 15 dBm

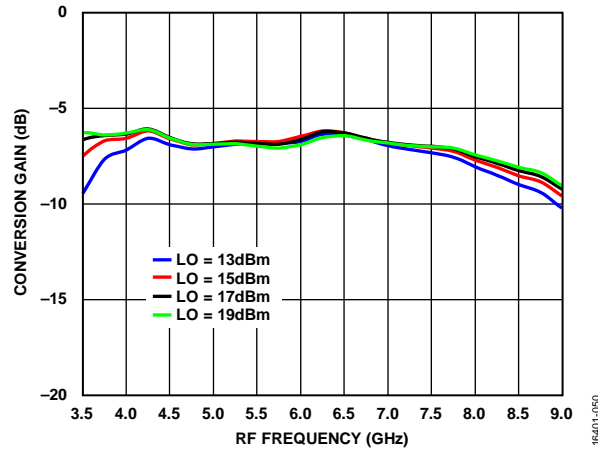

Figure 46. Conversion Gain vs. RF Frequency at Various LO Power Levels,  $T_A = 25^\circ\text{C}$

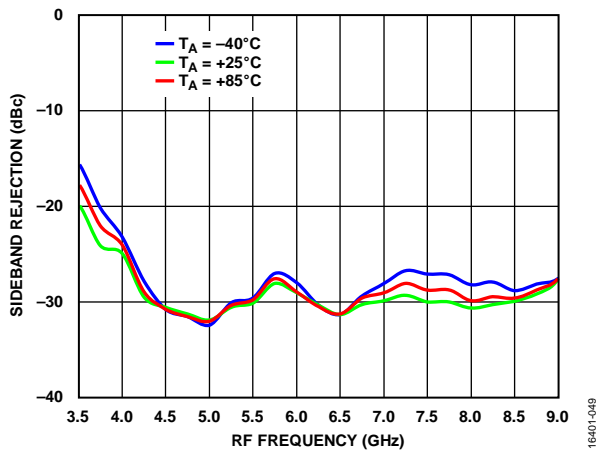

Figure 45. Sideband Rejection vs. RF Frequency at Various Temperatures, LO = 15 dBm

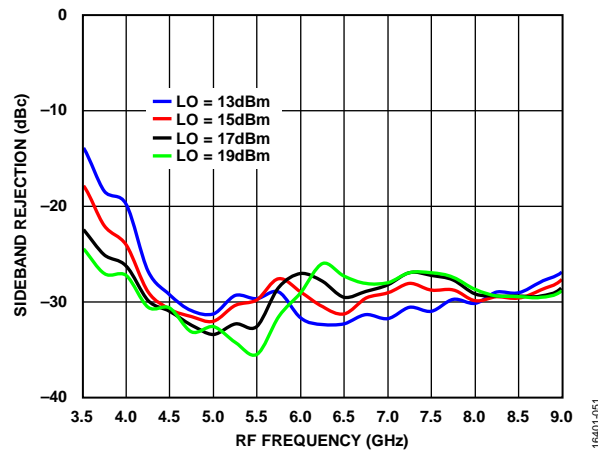

Figure 47. Sideband Rejection vs. RF Frequency at Various LO Power Levels,  $T_A = 25^\circ\text{C}$

**$IF_{IN} = 100 \text{ MHz}$ , Upper Side Band (Low-Side LO)**

Data taken as single sideband upconverter with external  $90^\circ$  hybrid at the IF ports.

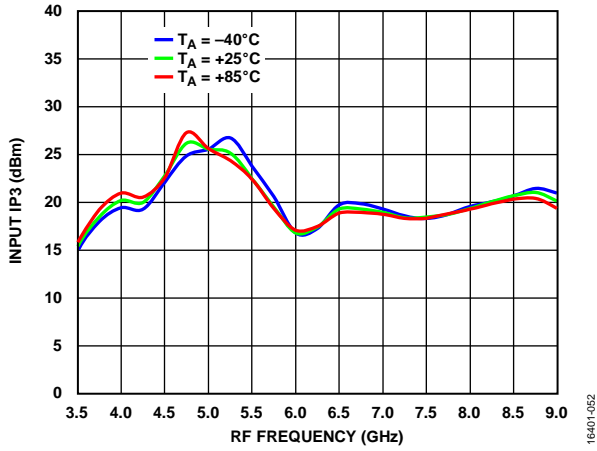

Figure 48. Input IP3 vs. RF Frequency at Various Temperatures, LO = 15 dBm

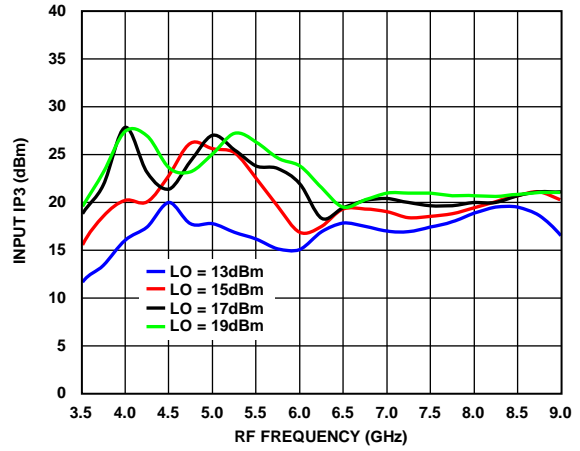

Figure 50. Input IP3 vs. RF Frequency at LO Power Levels,  $T_A = 25^\circ\text{C}$

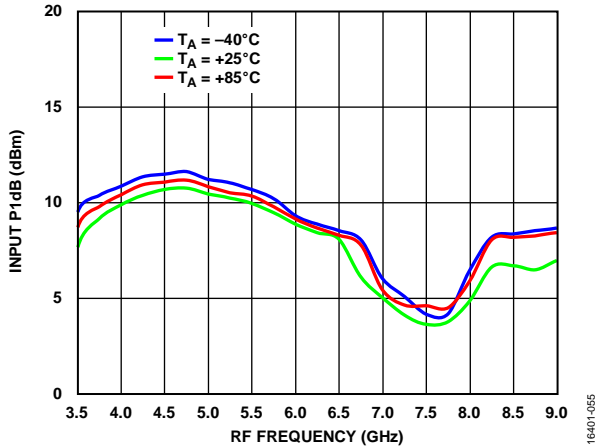

Figure 49. Input P1dB vs. RF Frequency at Various Temperatures, LO = 15 dBm

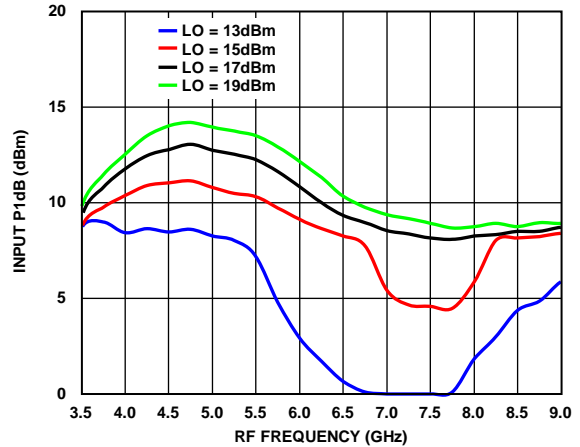

Figure 51. Input P1dB vs. RF Frequency at Various LO Power Levels,  $T_A = 25^\circ\text{C}$

## $IF_{IN} = 100 \text{ MHz}$ , Lower Side Band (High-Side LO)

Data taken as single sideband upconverter with external  $90^\circ$  hybrid at the IF ports.

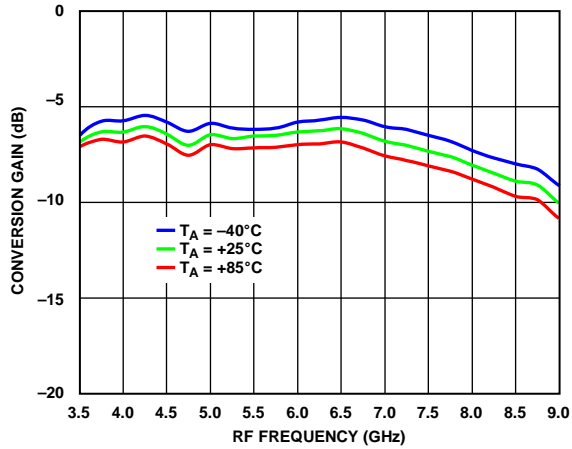

Figure 52. Conversion Gain vs. RF Frequency at Various Temperatures, LO = 15 dBm

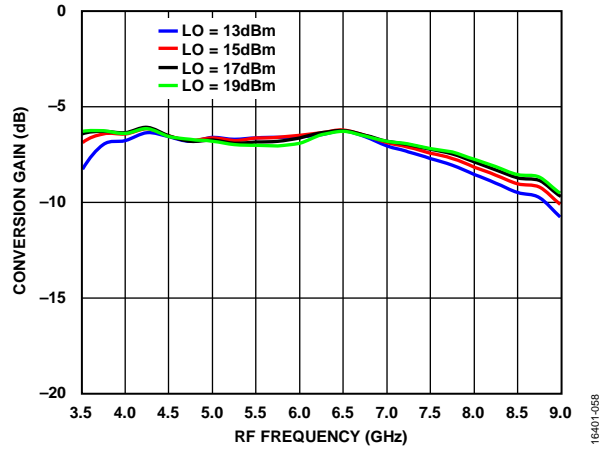

Figure 54. Conversion Gain vs. RF Frequency at Various LO Power Levels,  $T_A = 25^\circ\text{C}$

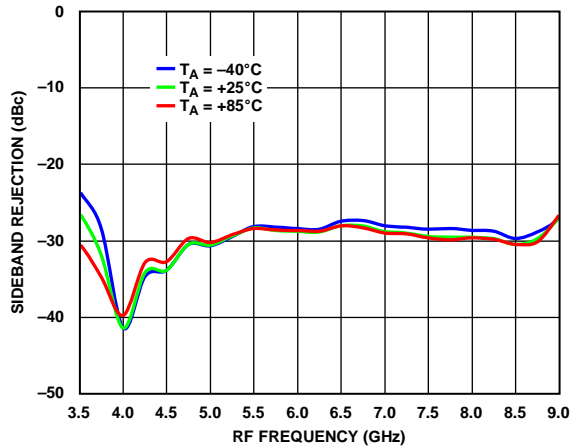

Figure 53. Sideband Rejection vs. RF Frequency at Various Temperatures, LO = 15 dBm

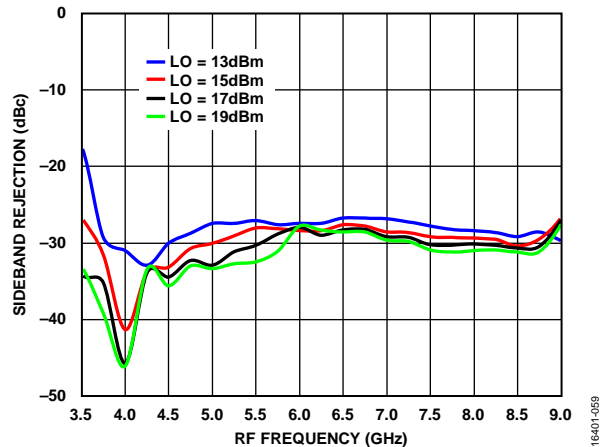

Figure 55. Sideband Rejection vs. RF Frequency at Various LO Power Levels,  $T_A = 25^\circ\text{C}$

**$IF_{IN} = 100\text{ MHz}$ , Lower Side Band (High-Side LO)**

Data taken as single sideband upconverter with external  $90^\circ$  hybrid at the IF ports.

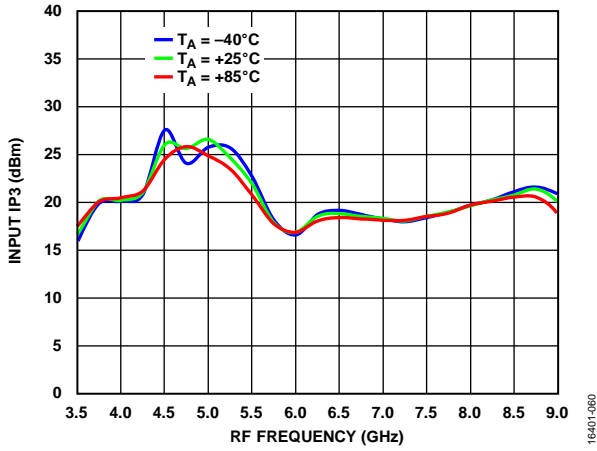

Figure 56. Input IP3 vs. RF Frequency at Various Temperatures, LO = 15 dBm

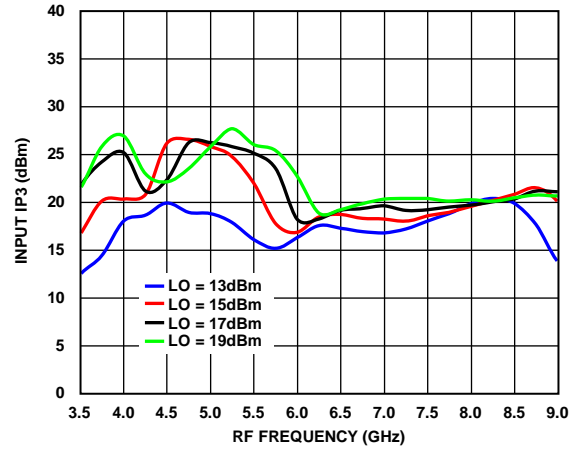

Figure 58. Input IP3 vs. RF Frequency at Various LO Power Levels,  $T_A = 25^\circ\text{C}$

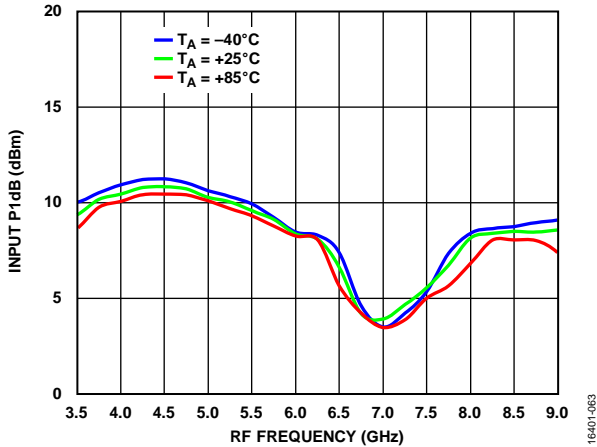

Figure 57. Input P1dB vs. RF Frequency at Various Temperatures, LO = 15 dBm

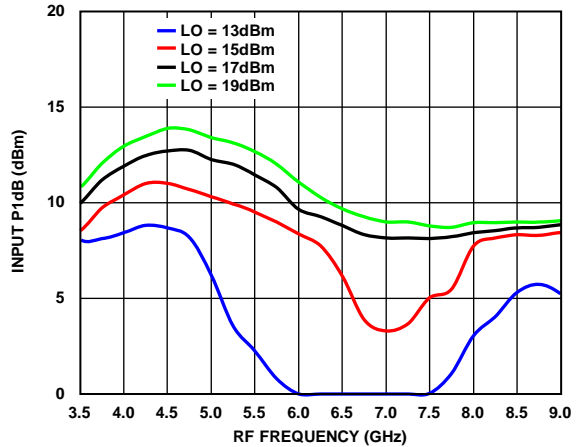

Figure 59. Input P1dB vs. RF Frequency at Various LO Power Levels,  $T_A = 25^\circ\text{C}$

**$IF_{IN} = 2500$  MHz, Upper Side Band (Low-Side LO)**

Data taken as single sideband upconverter with external 90° hybrid at the IF ports.

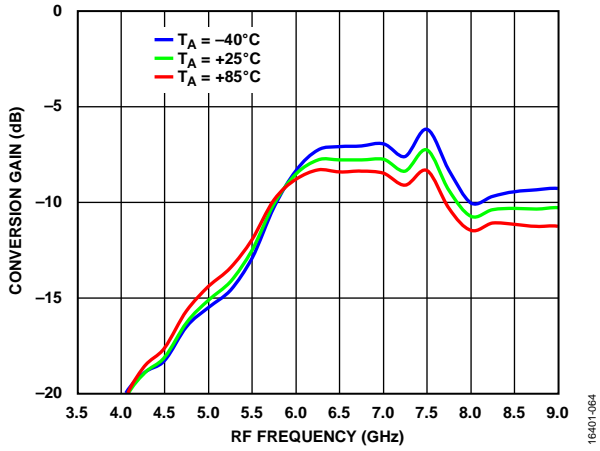

Figure 60. Conversion Gain vs. RF Frequency at Various Temperatures, LO = 15 dBm

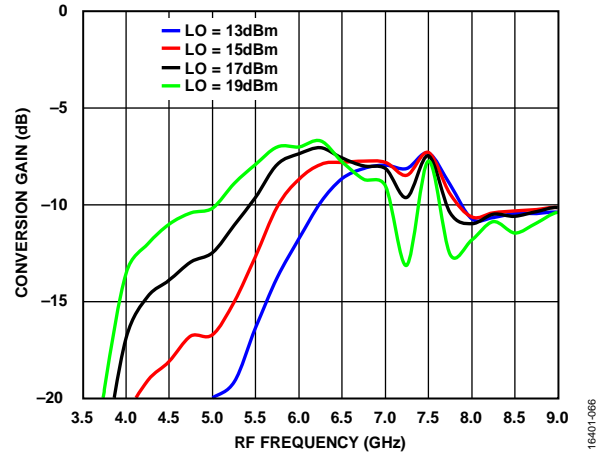

Figure 63. Conversion Gain vs. RF Frequency at Various LO Power Levels,  $T_A = 25^\circ\text{C}$

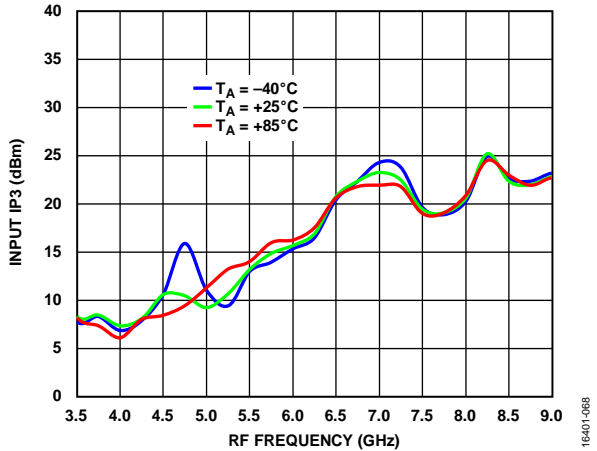

Figure 61. Input IP3 vs. RF Frequency at Various Temperatures, LO = 15 dBm

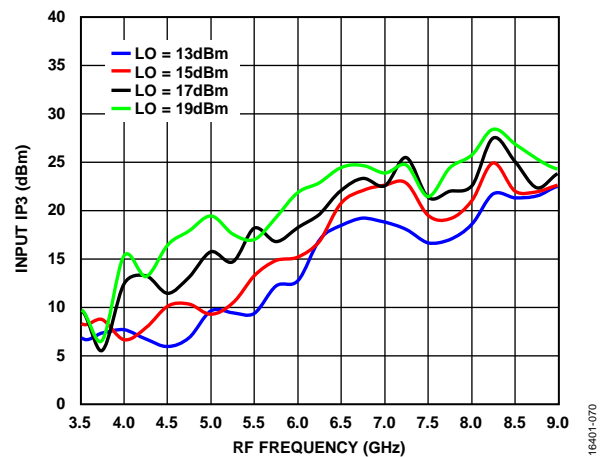

Figure 64. Input IP3 vs. RF Frequency at Various LO Power Levels,  $T_A = 25^\circ\text{C}$

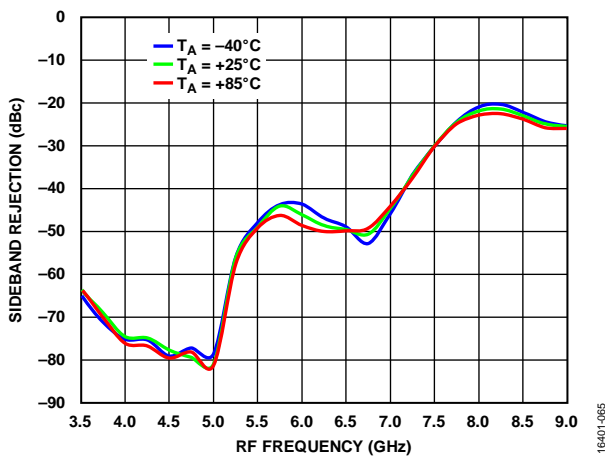

Figure 62. Sideband Rejection vs. RF Frequency at Various Temperatures, LO = 15 dBm

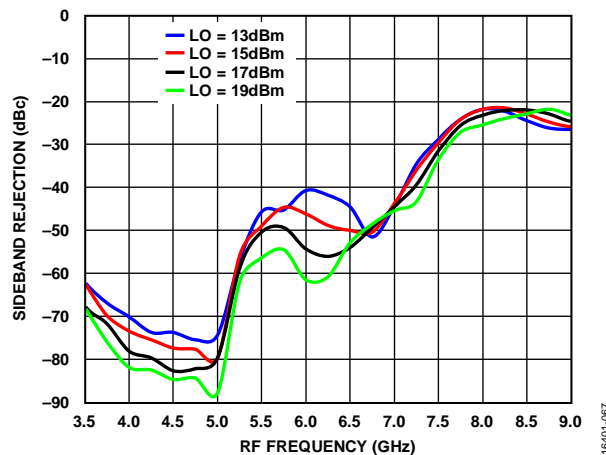

Figure 65. Sideband Rejection vs. RF Frequency at Various LO Power Levels,  $T_A = 25^\circ\text{C}$



**$IF_{IN} = 2500 \text{ MHz}$ , Lower Side Band (High-Side LO)**

Data taken as single sideband upconverter with external  $90^\circ$  hybrid at the IF ports.

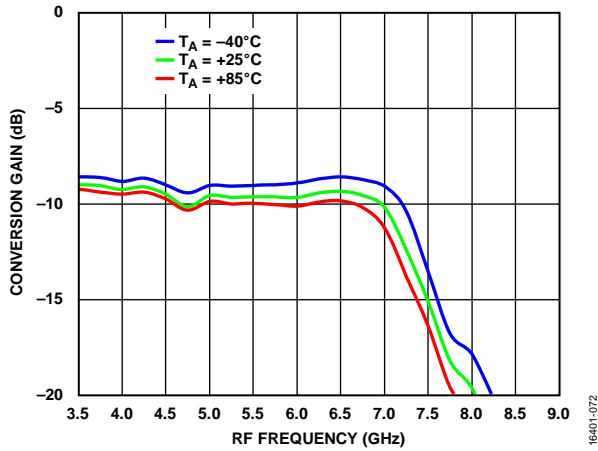

Figure 66. Conversion Gain vs. RF Frequency at Various Temperatures, LO = 15 dBm

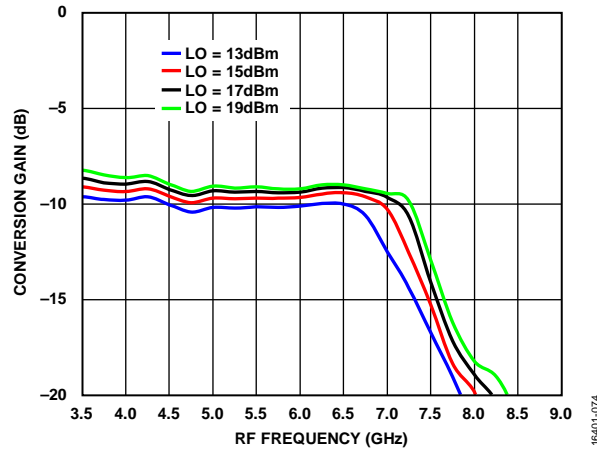

Figure 69. Conversion Gain vs. RF Frequency at Various LO Power Levels,  $T_A = 25^\circ\text{C}$

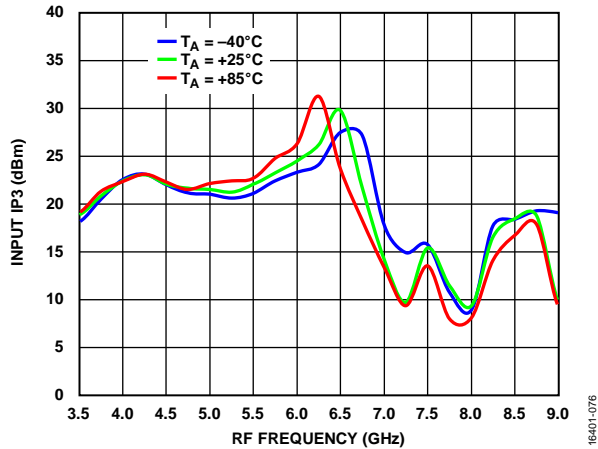

Figure 67. Input IP3 vs. RF Frequency at Various Temperatures, LO = 15 dBm

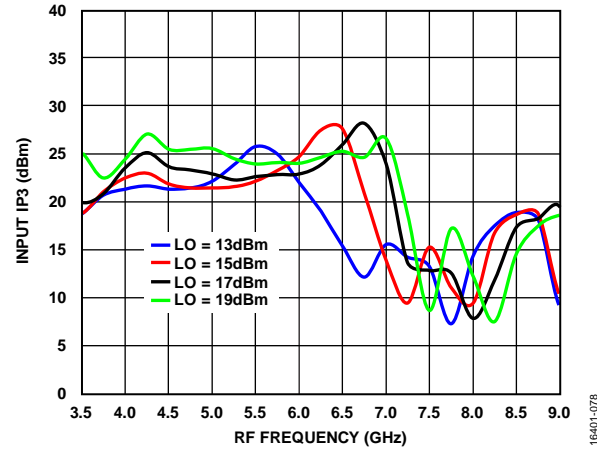

Figure 70. Input IP3 vs. RF Frequency at Various LO Power Levels,  $T_A = 25^\circ\text{C}$

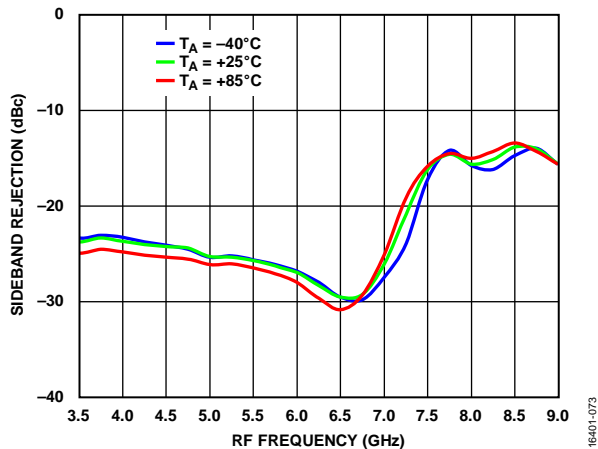

Figure 68. Sideband Rejection vs. RF Frequency at Various Temperatures, LO = 15 dBm

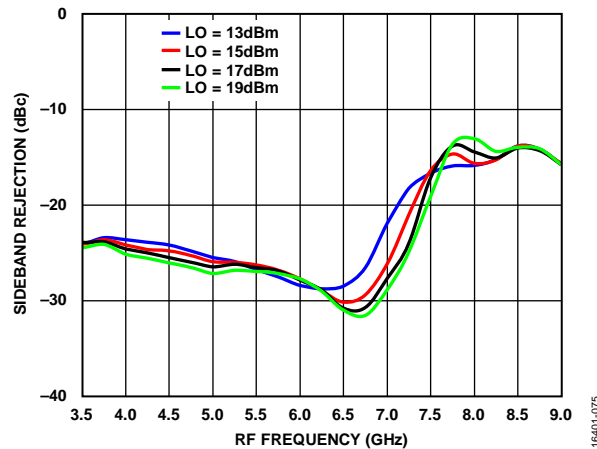

Figure 71. Sideband Rejection vs. RF Frequency at Various LO Power Levels,  $T_A = 25^\circ\text{C}$

PHASE AND AMPLITUDE BALANCE—DOWNCONVERTER

Upper Sideband, IF = 100 MHz

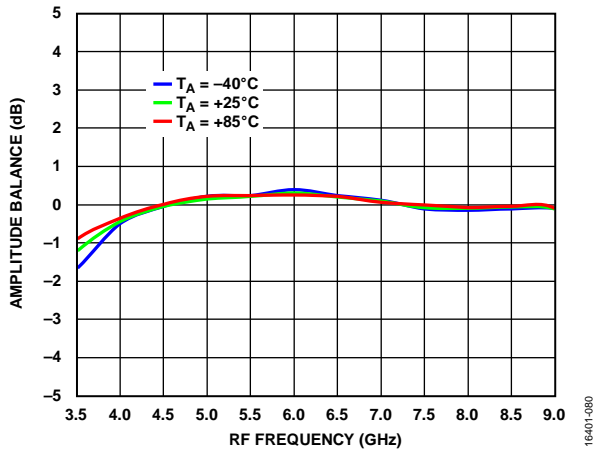

Figure 72. Amplitude Balance vs. RF Frequency at Various Temperatures, LO = 15 dBm

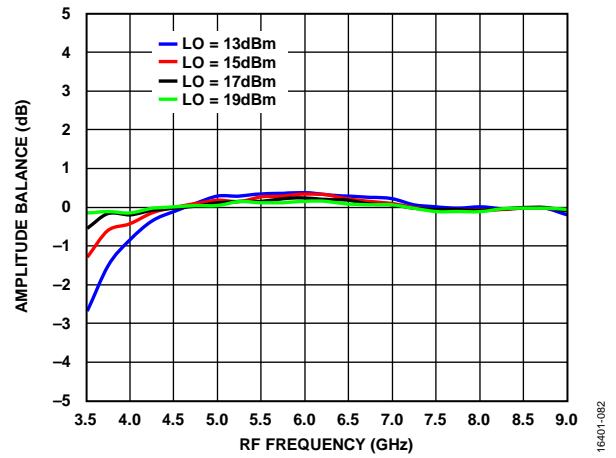

Figure 74. Amplitude Balance vs. RF Frequency at Various LO Power Levels, TA = 25°C

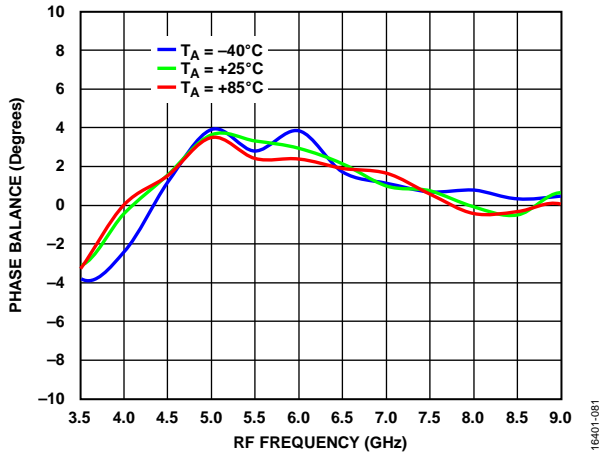

Figure 73. Phase Balance vs. RF Frequency at Various Temperatures, LO = 15 dBm

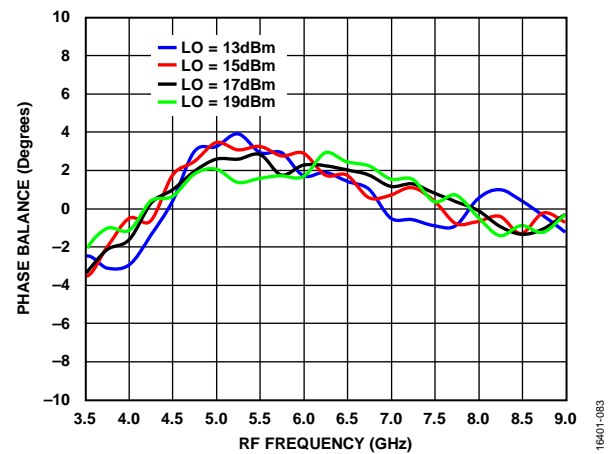

Figure 75. Phase Balance vs. RF Frequency at Various LO Power Levels, TA = 25°C

Lower Sideband, IF = 100 MHz

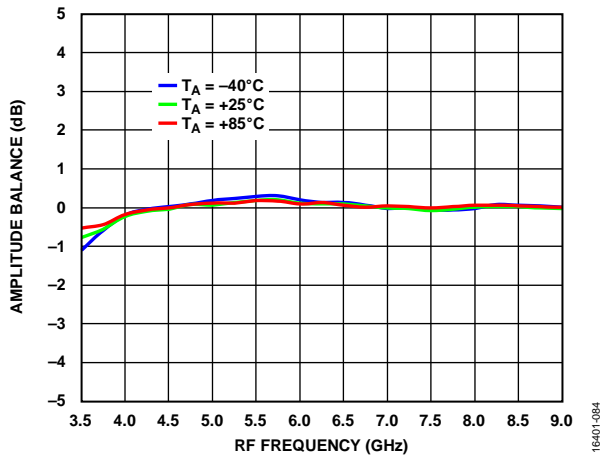

Figure 76. Amplitude Balance vs. RF Frequency at Various Temperatures, LO = 15 dBm

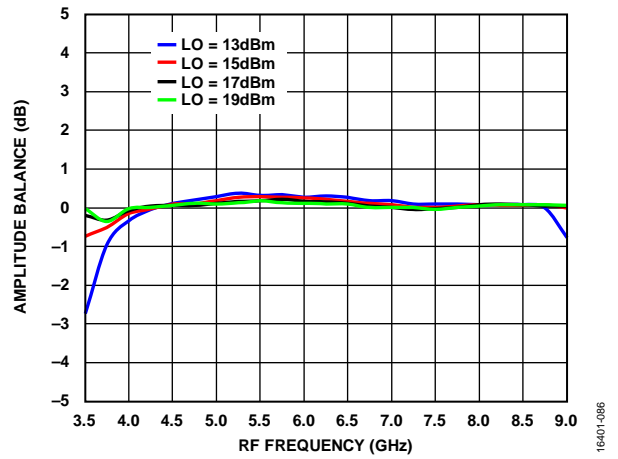

Figure 78. Amplitude Balance vs. RF Frequency at Various LO Power Levels, TA = 25°C

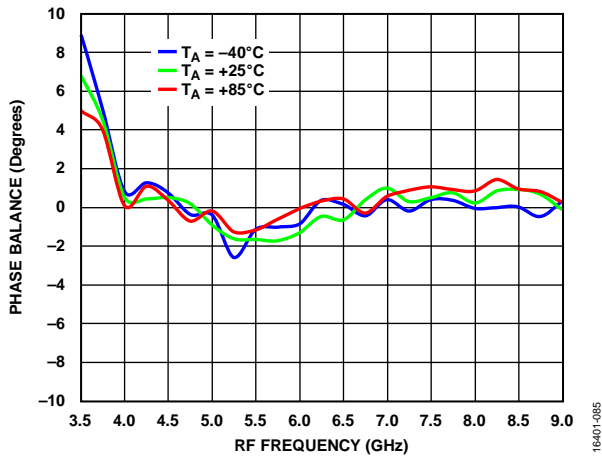

Figure 77. Phase Balance vs. RF Frequency at Various Temperatures, LO = 15 dBm

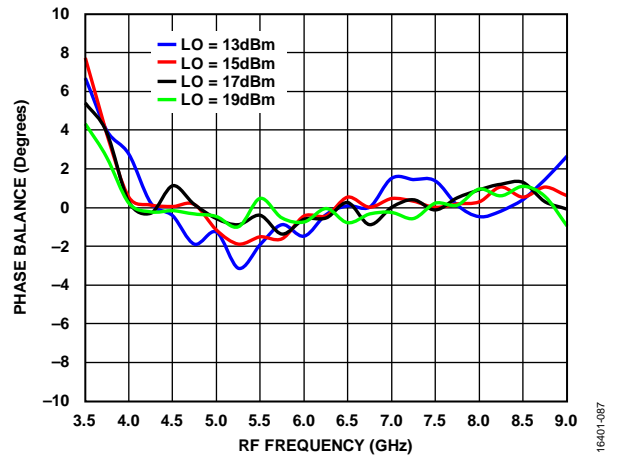

Figure 79. Phase Balance vs. RF Frequency at Various LO Power Levels, TA = 25°C

**ISOLATION AND RETURN LOSS**

Downconverter performance at IF = 100 MHz, upper sideband (low-side LO).

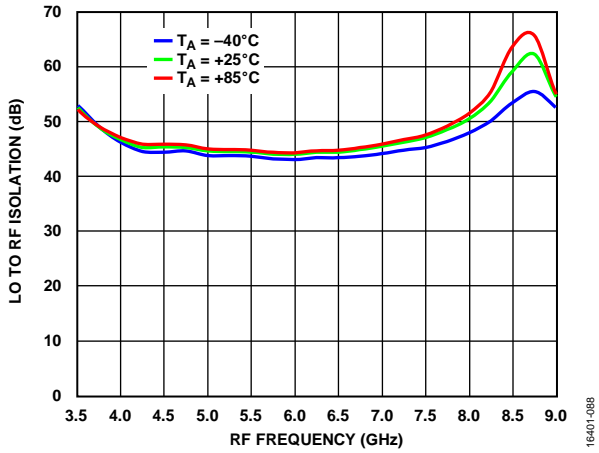

Figure 80. LO to RF Isolation vs. RF Frequency at Various Temperatures, LO = 15 dBm

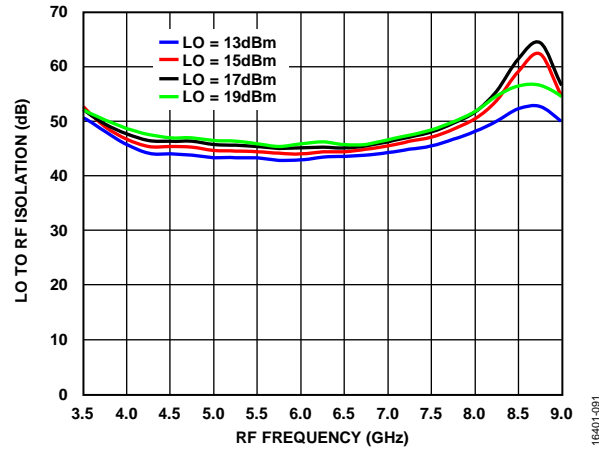

Figure 83. LO to RF Isolation vs. RF Frequency at Various LO Power Levels, TA = 25°C

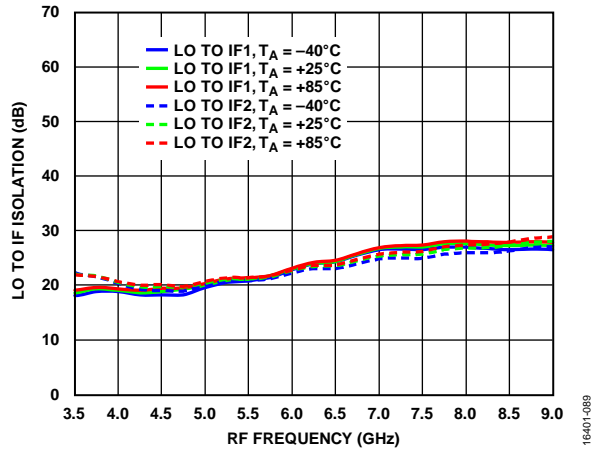

Figure 81. LO to IF Isolation vs. RF Frequency at Various Temperatures, LO = 15 dBm

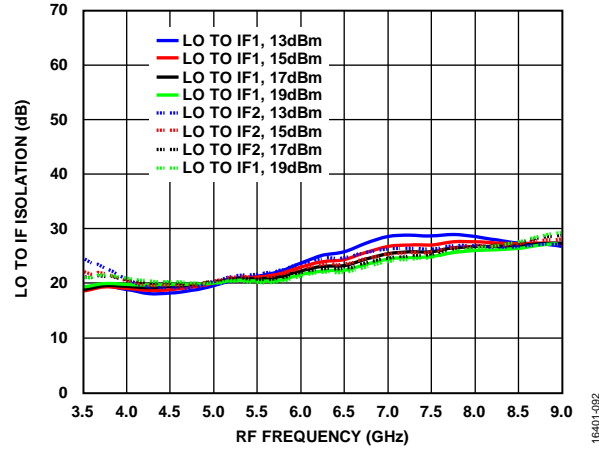

Figure 84. LO to IF Isolation vs. RF Frequency at Various LO Power Levels, TA = 25°C

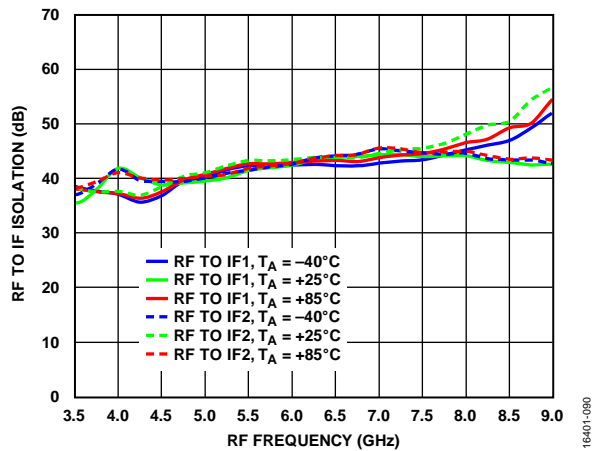

Figure 82. RF to IF Isolation vs. RF Frequency at Various Temperatures, LO = 15 dBm

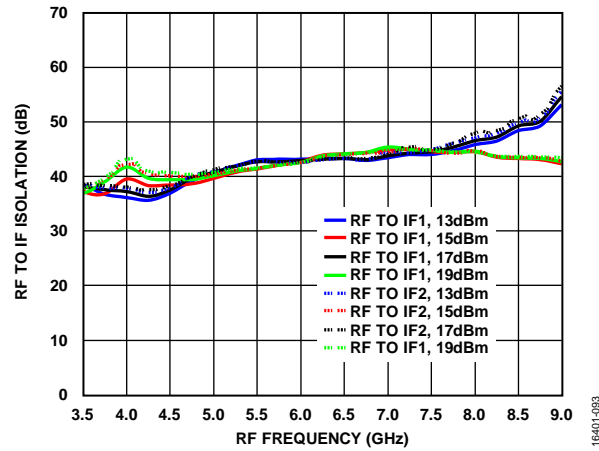

Figure 85. RF to IF Isolation vs. RF Frequency at Various LO Power Levels, TA = 25°C

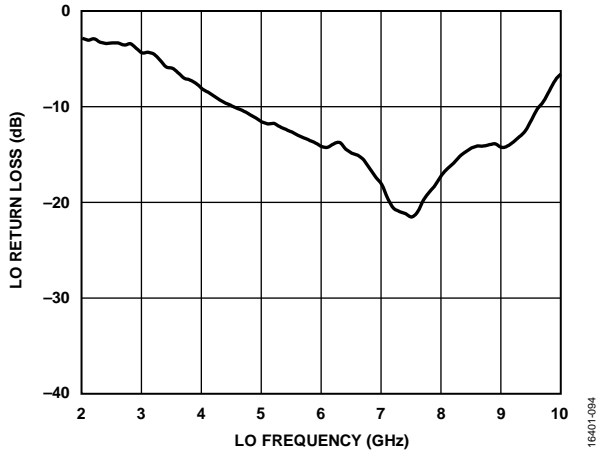

Figure 86. LO Return Loss vs. LO Frequency at LO = 15 dBm,  $T_A = 25^\circ\text{C}$

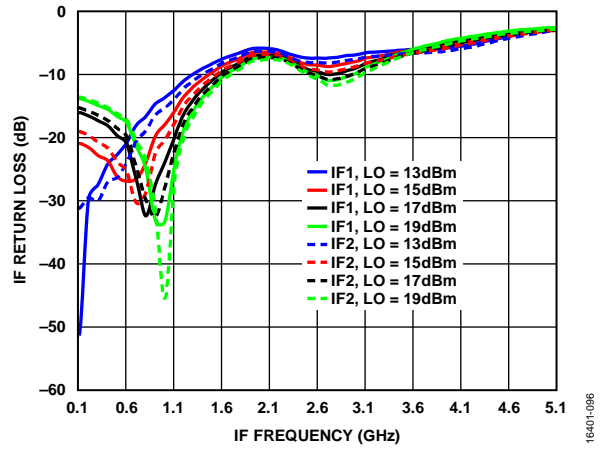

Figure 88. IF Return Loss vs. IF Frequency at Various LO Power Levels, LO = 5 GHz,  $T_A = 25^\circ\text{C}$

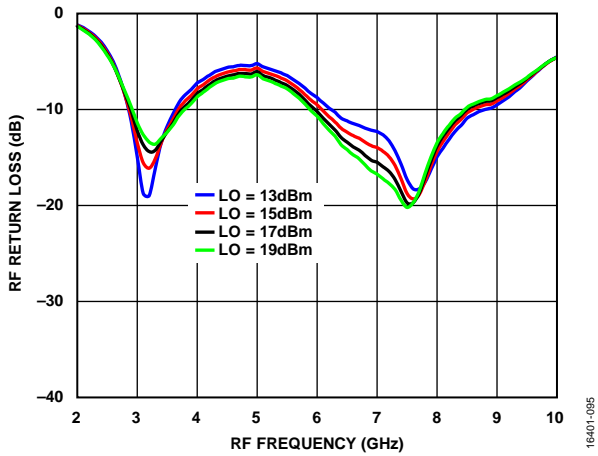

Figure 87. RF Return Loss vs. RF Frequency at Various LO Power Levels, LO = 5 GHz,  $T_A = 25^\circ\text{C}$

**IF BANDWIDTH—DOWNCONVERTER**

**LO = 5 GHz, Upper Side Band**

Data taken as image-reject mixer with external 90° hybrid at the IF ports.

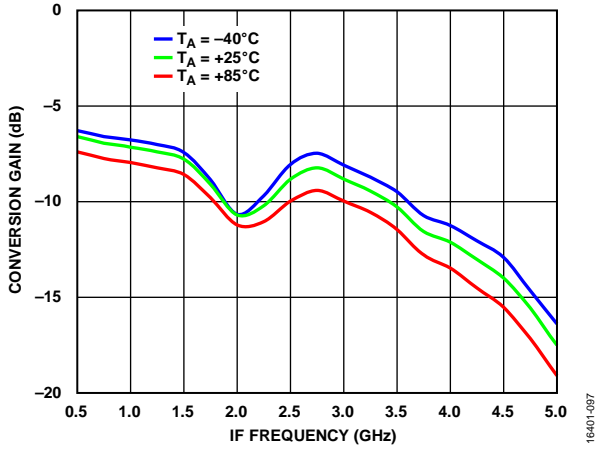

Figure 89. Conversion Gain vs. IF Frequency at Various Temperatures, LO = 15 dBm

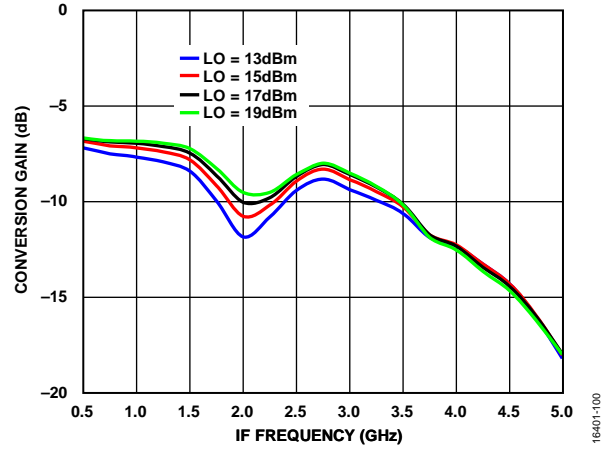

Figure 92. Conversion Gain vs. IF Frequency at Various LO Power Levels, TA = 25°C

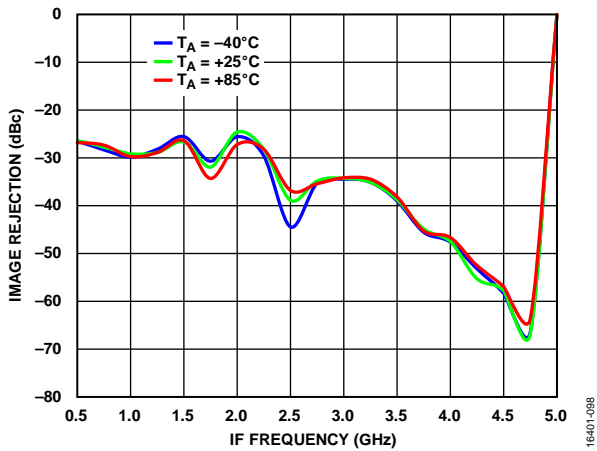

Figure 90. Image Rejection vs. IF Frequency at Various Temperatures, LO = 15 dBm

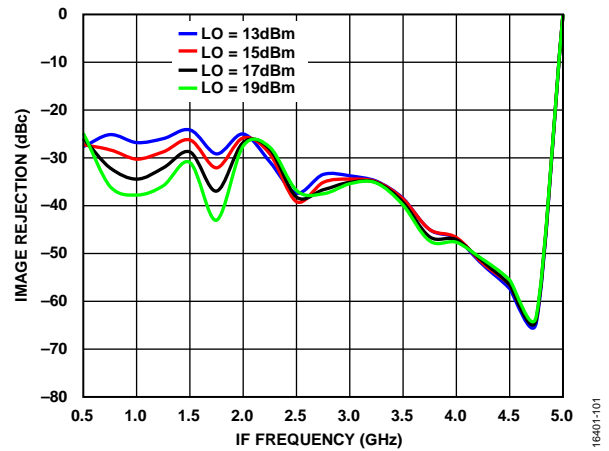

Figure 93. Image Rejection vs. IF Frequency at Various LO Power Levels, TA = 25°C

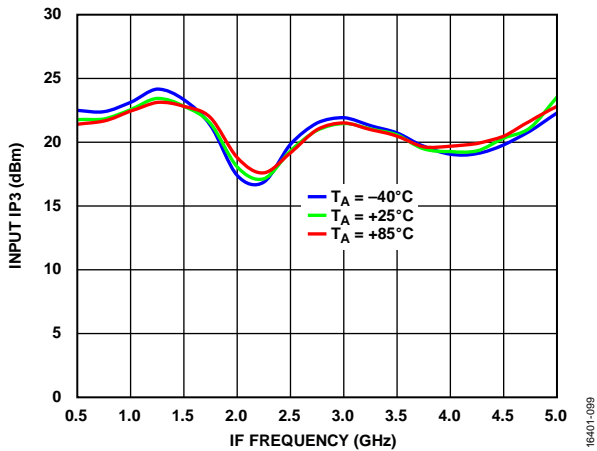

Figure 91. Input IP3 vs. IF Frequency at Various Temperatures, LO = 15 dBm

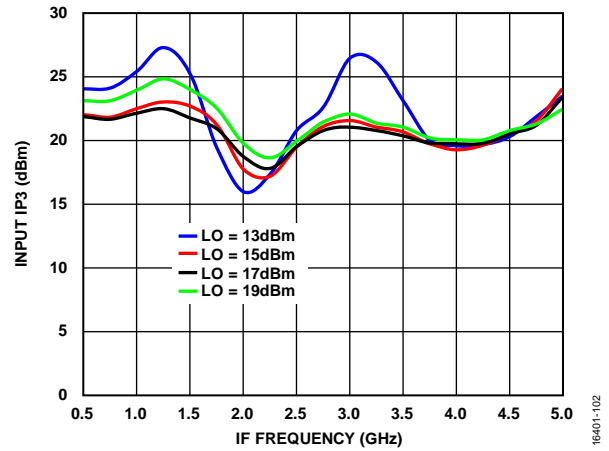

Figure 94. Input IP3 vs. IF Frequency at Various LO Power Levels, TA = 25°C

**LO = 8 GHz, Lower Side Band**

Data taken as image reject mixer with external 90° hybrid at the IF ports.

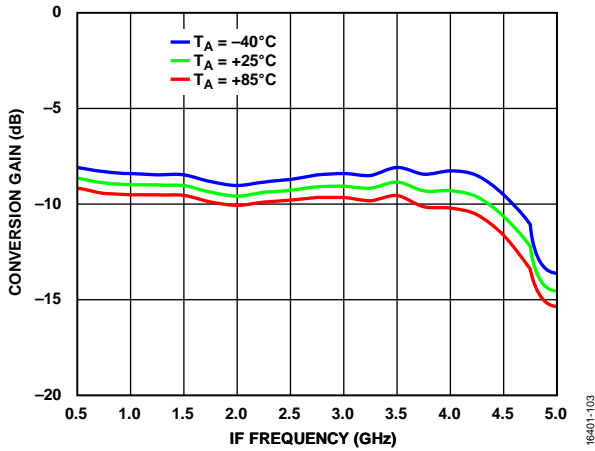

Figure 95. Conversion Gain vs. IF Frequency at Various Temperatures, LO = 15 dBm

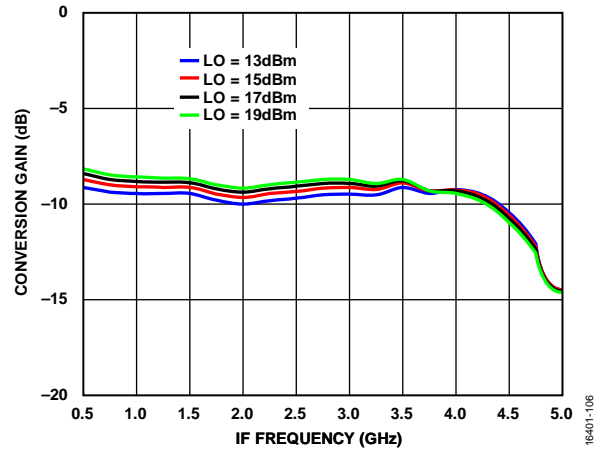

Figure 98. Conversion Gain vs. IF Frequency at Various LO Power Levels, TA = 25°C

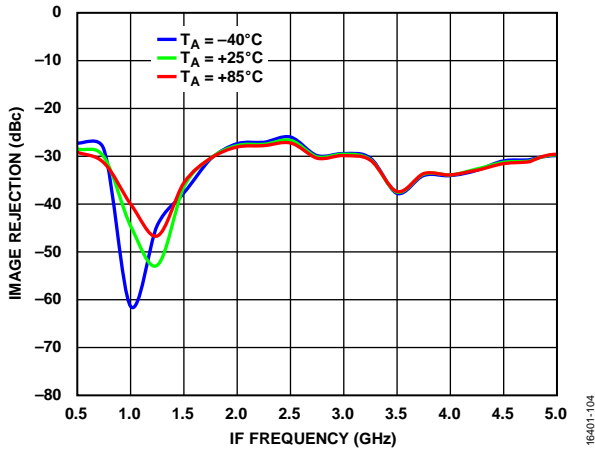

Figure 96. Image Rejection vs. IF Frequency at Various Temperatures, LO = 15 dBm

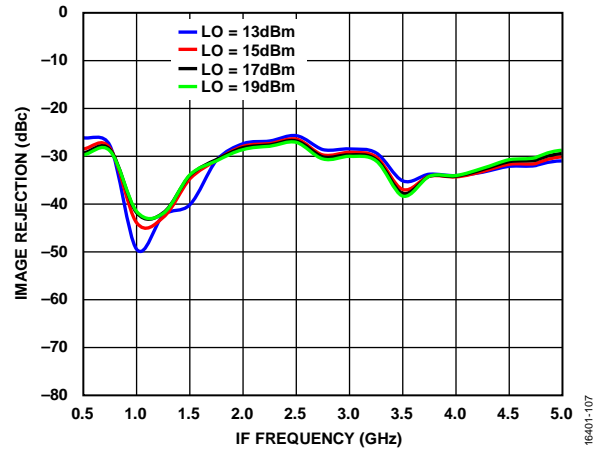

Figure 99. Image Rejection vs. IF Frequency at Various LO Power Levels, TA = 25°C

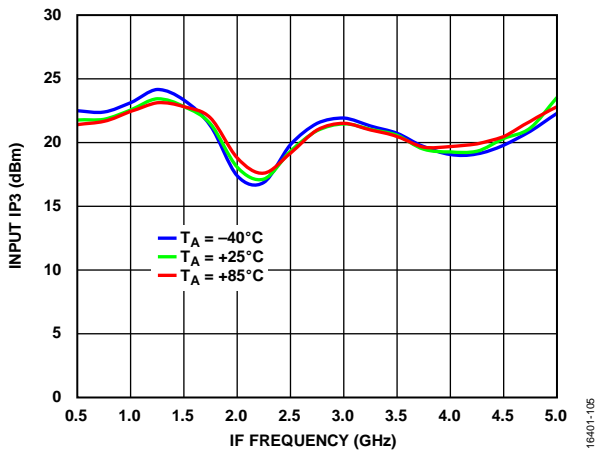

Figure 97. Input IP3 vs. IF Frequency at Various Temperatures, LO = 15 dBm

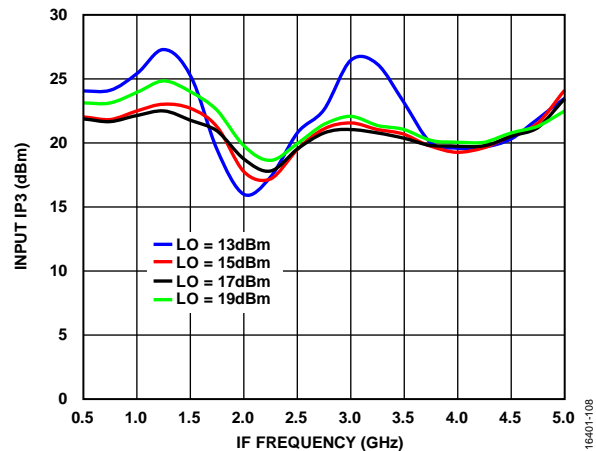

Figure 100. Input IP3 vs. IF Frequency at Various LO Power Levels, TA = 25°C

**SPURIOUS AND HARMONICS PERFORMANCE**

**LO Harmonics**

LO = 15 dBm, and all values in dBc below input LO level measured at RF port.

**Table 5. LO Harmonics at RF Port**

LO Frequency (GHz)	N <sub>LO</sub> Spur at RF Port			
	1	2	3	4
2.5	60	54	64	66
3.5	48	42	68	91
4.5	43	39	62	88
5.5	42	65	91	75
6.5	43	70	76	80
7.5	47	77	66	92

LO = 15 dBm, and all values in dBc below input LO level measured at IF port.

**Table 6. LO Harmonics at IF Port**

LO Frequency (GHz)	N <sub>LO</sub> Spur at IF Port			
	1	2	3	4
2.5	24	54	42	59
3.5	20	47	46	82
4.5	20	47	65	91
5.5	22	22	62	73
6.5	30	89	80	104
7.5	34	93	95	117

**M × N Spurious Outputs**

**Downconverter Performance**

Mixer spurious products are measured in dBc from the IF output power level (M × RF – N × LO). N/A means not applicable.

RF = 5.6 GHz, LO = 5.5 GHz, RF power = –10 dBm, and LO power = 15 dBm.

M × RF		N × LO				
		0	1	2	3	4
	0	0	–14	+37	+32	+50
	1	+32	0	+39	+48	+66
	2	+89	+59	+66	+58	+93
	3	+92	+93	+84	+80	+85
	4	+85	+91	+93	+94	+99

RF = 7.4 GHz, LO = 7.5 GHz, RF power = –10 dBm, and LO power = 15 dBm.

M × RF		N × LO				
		0	1	2	3	4
	0	0	–12	+32	+29	+40
	1	+32	0	+45	+48	+59
	2	+84	+55	+72	+56	+92
	3	+89	+92	+88	+72	+90
	4	+76	+56	+87	+90	+93

**Upconverter Performance**

Mixer spurious products are measured in dBc from the RF output power level (M × IF<sub>IN</sub> + N × LO). N/A means not applicable.

IF<sub>IN</sub> = 0.1 GHz, LO = 5.5 GHz, RF power = –10 dBm, and LO power = 15 dBm.

M × IF <sub>IN</sub>		N × LO				
		0	1	2	3	4
	–5	99	95	96	92	92
	–4	100	85	91	92	91
	–3	98	59	75	87	86
	–2	95	48	62	68	56
	–1	80	0	32	45	51
	+0	N/A	9.4	27	28	15
	+1	80	0	32	43	51
	+2	96	48	66	68	55
	+3	100	55	76	85	88
	+4	100	84	94	94	90
	+5	98	96	94	90	90

IF<sub>IN</sub> = 0.1 GHz, LO = 7.5 GHz, RF power = –10 dBm, and LO power = 15 dBm.

M × IF <sub>IN</sub>		N × LO				
		0	1	2	3	4
	–5	102	95	95	92	81
	–4	101	87	94	90	81
	–3	101	61	82	78	83
	–2	100	50	74	67	60
	–1	79	0	41	30	55
	0	N/A	12	44	26	17
	+1	79	0	44	28	54
	+2	102	49	74	65	60
	+3	102	58	85	81	83
	+4	100	87	95	89	82
	+5	101	97	93	91	81



## THEORY OF OPERATION

The HMC525ALC4 is a compact GaAs, MMIC, I/Q mixer in a 24-terminal, RoHS compliant, ceramic LCC package. The device can be used as either an image reject mixer or a SSB upconverter. The mixer uses two standard double balanced mixer cells and a 90° hybrid fabricated in a GaAs, MESFET

process. This device is a much smaller alternative to a hybrid style image reject mixer and a SSB upconverter assembly. The HMC525ALC4 eliminates the need for wire bonding, allowing the use of the surface-mount manufacturing techniques.

## APPLICATIONS INFORMATION

### TYPICAL APPLICATION CIRCUIT

Figure 101 shows the typical application circuit for the HMC525ALC4. To select the appropriate sideband, an external 90° degree hybrid is needed. For applications not requiring operation to dc, use an off-chip dc blocking capacitor. For applications that require suppression of the LO signal at the output, use a bias tee or RF feed as shown in Figure 101. Ensure that the source or sink current used for LO suppression is <2 mA for each IF port to prevent damage to the device. The common-mode voltage for each IF port is 0 V.

To select the upper sideband when using as an upconverter, connect the IF1 pin to the 90° port of the hybrid, and connect the IF2 pin to the 0° port of the hybrid. To select the lower sideband, connect IF1 to the 0° port of the hybrid and IF2 to the 90° port of the hybrid. The input is from the sum port of the hybrid and the difference port is 50 Ω terminated.

To select the upper sideband (low-side LO) when using as a downconverter, connect the IF1 pin to the 0° port of the hybrid, and connect the IF2 pin to the 90° port of the hybrid. To select the lower sideband (high-side LO), connect the IF1 pin to the 90° port of the hybrid and IF2 to the 0° port of the hybrid. The output is from the sum port of the hybrid, and the difference port is 50 Ω terminated.

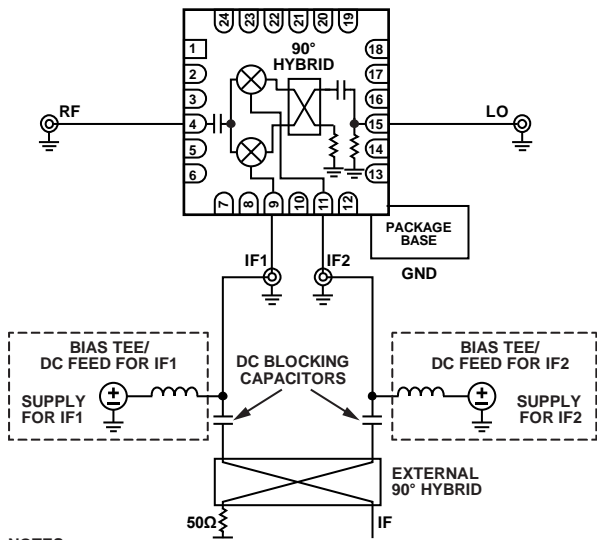

NOTES  
1. DASHED SECTIONS ARE OPTIONAL AND MEANT FOR LO NULLING.

Figure 101. Typical Application Circuit

### EVALUATION PCB INFORMATION

Use RF circuit design techniques for the circuit board used in the application. Ensure that signal lines have 50 Ω impedance and connect the package ground leads and the exposed pad directly to the ground plane (see Figure 103). Use a sufficient number of via holes to connect the top and bottom ground planes. The evaluation circuit board shown in Figure 103 is available from Analog Devices, Inc., upon request.

Table 7. Materials for Evaluation PCB EV1HMC525ALC4

Item	Description
PCB <sup>1</sup>	PCB, 109996-1
J1, J2	2.92 mm SubMiniature Version A (SMA) connectors, SRI connector gage
J3, J4	Gold plated SMA, edge mount with 0.02 inch pin connectors, Johnson SMA connectors
U1	Device under test, HMC525ALC4

<sup>1</sup> 109996-1 is the raw bare PCB identifier. Reference EV1HMC525ALC4 when ordering complete evaluation PCB.

**SOLDERING INFORMATION AND RECOMMENDED LAND PATTERN**

Figure 102 shows the recommended land pattern for the HMC525ALC4. The HMC525ALC4 is contained in a 4 mm × 4 mm, 24-terminal, ceramic LCC package, with an exposed ground pad (EPAD). This pad is internally connected to the ground of the chip. To minimize thermal impedance and ensure

electrical performance, solder the pad to the low impedance ground plane on the PCB. It is recommended that the ground planes on all layers under the pad be stitched together with vias, to further reduce thermal impedance. The land pattern on the EV1HMC525ALC4 evaluation board provides a simulated thermal resistance ( $\theta_{JC}$ ) of 161°C/W.

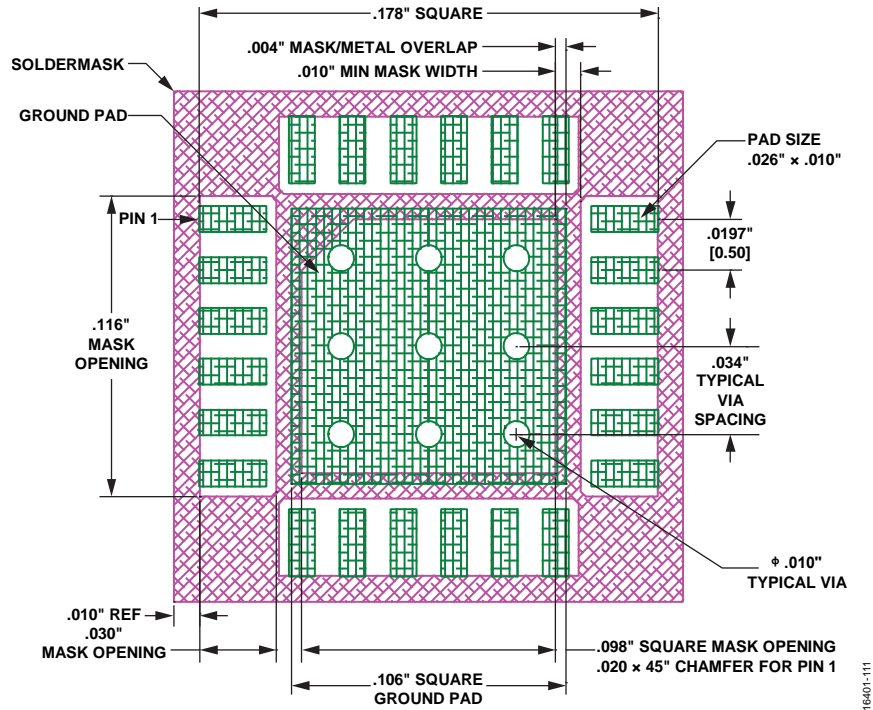

Figure 102. Evaluation Board Land Pattern for the HMC525ALC4 Package

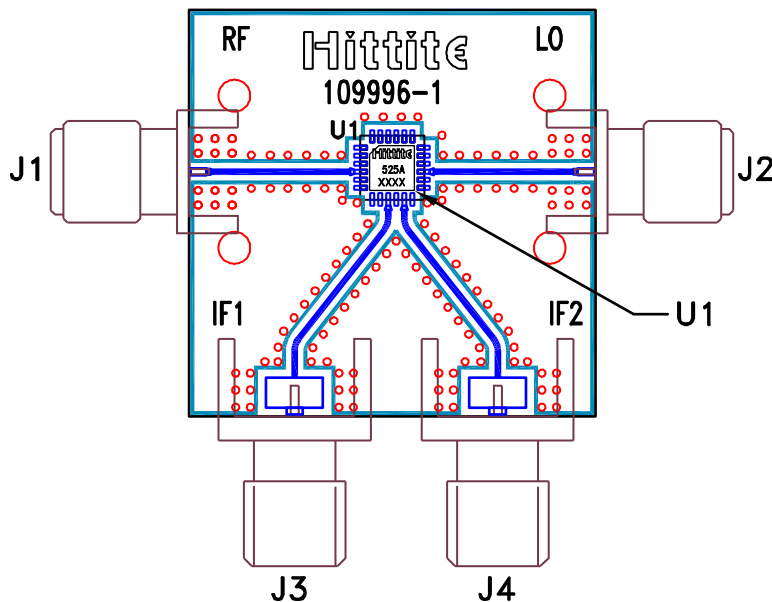

Figure 103. Evaluation PCB Top Layer

OUTLINE DIMENSIONS

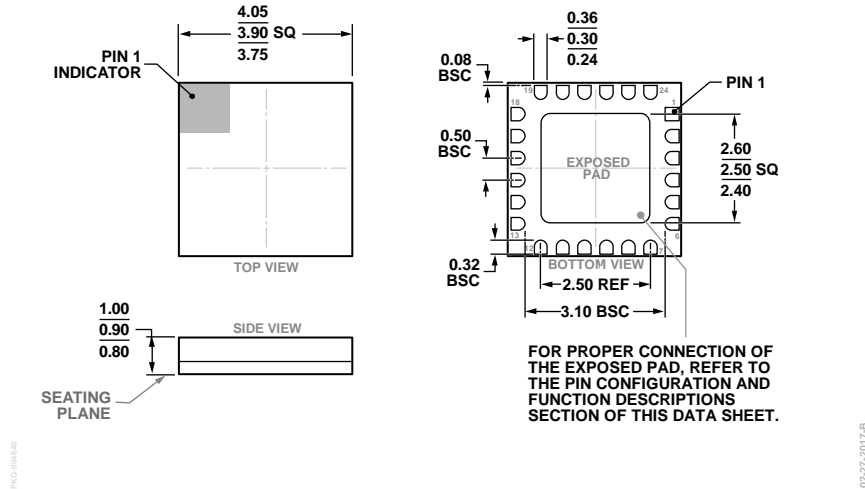

Figure 104. 24-Terminal Ceramic Leadless Chip Carrier [LCC] (E-24-1)  
Dimensions shown in millimeters

ORDERING GUIDE

Model <sup>1</sup>	Temperature Range	Package Description	Package Option
HMC525ALC4	-40°C to +85°C	24-Terminal Ceramic LCC	E-24-1
HMC525ALC4TR	-40°C to +85°C	24-Terminal Ceramic LCC	E-24-1
HMC525ALC4TR-R5	-40°C to +85°C	24-Terminal Ceramic LCC	E-24-1
EV1HMC525ALC4		Evaluation PCB Assembly	

<sup>1</sup> The HMC525ALC4, HMC525ALC4TR, and HMC525ALC4TR-R5 are RoHS compliant.

# Mouser Electronics

Authorized Distributor

Click to View Pricing, Inventory, Delivery & Lifecycle Information:

[Analog Devices Inc.:](#)

[HMC525ALC4](#) [HMC525ALC4TR](#) [HMC525ALC4TR-R5](#) [HMC525A](#)