



Bulletin HY11 5715-662/UK

Operating instructions

Series D1VW*-SC / D1DW*-SC (NG6)

Series D3W*-SC / D3DW*-SC (NG10)

Series D31DW*-SC (NG10)

Series D41VW*-SC (NG16)

Series D81VW*-SC / D91VW*-SC (NG25)

Translation of German original operating instructions



Series D1VW / D1DW / D3W / D3DW

Directly operated directional control valves

Subplate mounted

Slider type

Series D31DW / D41VW / D81VW / D91VW

Pilot operated directional control valves

Subplate mounted

Slider type

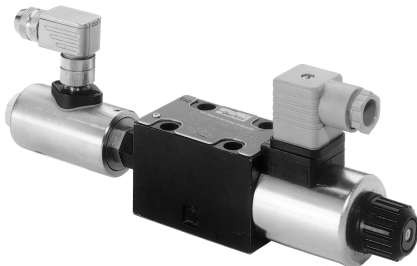

Parker Hannifin

Manufacturing Germany GmbH & Co. KG

Hydraulic Controls Division Europe

Gutenbergstr. 38

41564 Kaarst, Germany

Tel.: (+49) 181 99 44 43 0

Fax: (+49) 2131-513-230

E-mail: infohcd@parker.com

Copyright © 2014, Parker Hannifin Corp.

Note

These instructions contain important information that is essential in order to use these products safely and correctly. They are intended for users with specialist knowledge.

Observing the instructions will help you avoid hazards, repair costs and downtimes, and increase the reliability and service life of the product.

The user must determine whether the details given for the selected product are applicable to the required functions. Because of the different functions and work processes in a system, the user must check and ensure that the product characteristics meet all requirements in terms of functionality and safety.

These instructions must be kept available at all times at the location where the product is being used. They must be read and applied by everyone coming into contact with the product. Failure to observe the instructions may cause hazards.

Generally acknowledged rules for safe and correct working procedures must be observed in addition to these operating instructions and the binding regulations on accident prevention and environmental protection that are valid at the place of use.

Contents

1. Basic information	4
1.1. Warnings and symbols.....	4
1.2. General notes.....	4
1.3. Package contents.....	4
1.4. Warranty and liability.....	4
1.5. CE mark.....	4
1.6. Conformity.....	4
1.7. Electronic control system.....	5
1.8. Choice of solenoid.....	5
1.9. Pressure fluids.....	6
1.10. Venting of hydraulic system.....	6
1.11. Flushing.....	6
1.12. Product support.....	6
2. General notes on safety	6
2.1. Use of operating instructions.....	6
2.2. Compliance with other rules and instructions.....	6
2.3. Personnel requirements.....	7
2.4. Use of the product.....	7
2.5. Limits of use.....	7
2.6. Contaminations.....	7
3. Remaining risk	7
3.1. Allergic reactions.....	7
3.2. Leaking plugs.....	7
3.3. Lightning.....	7
3.4. Temperature.....	8
3.5. Power failure.....	8
3.6. Hydraulic.....	8
3.7. Electrical connection for position control.....	8
4. Correct use	8
5. Function	8
6. Transport	8
7. Storage	9
8. Commissioning	9
8.1. Installation instructions DCV.....	10
8.2. Electrical connections.....	10
8.3. Hydraulic requirements for pilot operated directional control valves.....	10
9. Operation	10
10. Troubleshooting	10
11. Modification	12
12. Service/maintenance	12
13. Decommissioning	12
14. Disposal	12
15. Other documentation	13
15.1. Other applicable standards / rules.....	13
15.2. Declaration of Conformity.....	14
16. Technical data	15
16.1. Position control switch.....	15
16.2. Series D1VW / D1DW.....	17
16.3. Series D3W / D3DW.....	18
16.4. Series D31DW.....	19
16.5. Series D41VW.....	20
16.6. Series D81VW / D91VW.....	21
17. Dimensions	22
17.1. Series D1VW / D1DW.....	22
17.2. Series D3W / D3DW.....	23
17.3. Series D31DW.....	24
17.4. Series D41VW.....	24
17.5. Series D81VW / D91VW.....	25

1. Basic information

1.1. Warnings and symbols

The following symbols are used to identify important information.



Special information about requirements that must be noted/observed by the user.



Information about a hazard that may cause injury or damage.

1.2. General notes

1.2.1. Technical changes

We reserve the right to make technical changes as a result of further development of the product described in these operating instructions. Figures and drawings in these instructions are simplified depictions. As a result of developments, improvements and changes to the product, it is possible that the figures are not fully consistent with the valve in operation. The technical details and dimensions are non-binding. They may not form the basis of any claims. Copyright reserved.

1.2.2. Product name

The safety valves of series D1VW* / D1DW* / D3W* / D3DW* / D31DW* / D41VW* / D81VW* / D91VW* are named DCV in the rest of the documentation.

1.3. Package contents

The package contents for the products are:

- Safety valve of the series DCV
- Operating instructions with declaration of conformity

1.4. Warranty and liability

In principle the general terms and conditions of sale and delivery are applicable.

We cannot accept warranty or liability claims in respect of personal injury or material damage in the following circumstances:

- If the product is used other than as specified
- If the installation, commissioning, operation and maintenance of the product are incorrect
- If the product is used with safety devices that are defective or not properly installed
- If the operating instructions are not followed with regard to transport, storage, commissioning, operation, modification, maintenance/servicing, decommissioning/removal

- If unauthorised structural changes are made to the product
- If wear and tear are not properly monitored
- If repairs are carried out incorrectly
- If outages are caused by a third party
- If outages are the result of force majeure

1.5. CE mark

The CE mark appears on the main nameplate. If the product is installed as part of a larger machine, this larger machine is in turn subject to EU directives and must therefore obtain a general CE mark for the machine as a whole. The machine must not enter circulation in the EU until this is done.

1.6. Conformity

The declaration of conformity (see section 15 "Other documents") attests that the products comply with all essential health and safety requirements set out in Annex I of the Machinery Directive 2006/42/EC.



If our product is used other than as specified, hazards may occur that could not be foreseen by the manufacturer. Any result loss or damage is not the responsibility of Parker Hannifin.



If the described product is installed in a machine that came into circulation before 1995, note the following:

If the function has not been changed significantly,

commissioning may not take place until conformity with national occupational health and safety provisions has been established for the machine as a whole, in particular those provisions implementing the Use of Work Equipment Directive

If the function has been changed significantly,

a new conformity procedure must be carried out in accordance with the Machinery Directive 2006/42/EC.

1.7. Electronic control system

The DCV valve must be operated by the user with a suitable control system.
 The valve is connected using separate wires for solenoids/position control.

1.7.1. Solenoid connection

Each solenoid connection requires one plug 2 + PE as specified in EN 175301-803.

Connection of plug

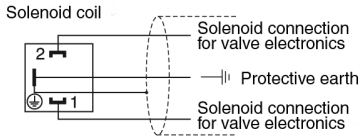

The plugs for the solenoids of the DCV valves must be ordered separately.

Deliverable version

Thread	Colour	Mark	Order no.
PG9	grey	A	5001711
PG9	black	B	5001710
PG11	grey	A	5001717
PG11	black	B	5001716

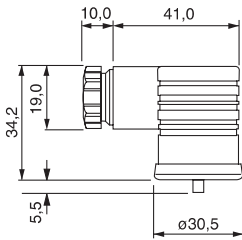

The wiring must meet the following specifications:

Type	Flexible control cable, 3-core
Size	Min. 1.5 mm ²
External diameter	PG9: 4.5...7 mm PG11: 6...9 mm
Length	Max. 50 m

For lengths >50 m please contact your representative.

The sealing surface of the valve must be properly connected to the earthed frame of the machine. Connect the earth wire and cable shield to the protective earth in the electrical cabinet.

Use the screw connectors to attach the wires to the plug. Use a suitable tool to tighten the screw at the cable entry point.

Failure to tighten the screw connectors may cause the connectors to loosen and may impair the seal.

If you are using plugs from other manufacturers, follow the relevant instructions.

Short circuits between the wires, poor workmanship or incorrect attachment of the shielding may cause disruption and the failure of the valve and the electronic control system.

1.7.2. Sensor connection

See "Technical data" section 16.1

1.8. Choice of solenoid

The choice of a suitable solenoid is an important factor in the operational reliability of the valve. Various valve series are available with several options for solenoid voltage. If the solenoid can be adjusted by setting parameters in the electronic control system, the suitable solenoid options must be selected.

Note about using valves with actuating solenoids:

The current drops as the solenoid heats up. The lower current has no effect on valve operation, provided the specified voltage is maintained at the valve (see the technical data).

A suitable tool must if necessary be used for manual emergency actuation of the solenoid.

1.9. Pressure fluids

Certain rules apply to valve operation using different pressure fluids:

Mineral oil		No restrictions
HFA	Oil in water emulsions	Mandatory check
HFB	Water in oil emulsions	Mandatory check
HFC	Water glycols	Possible restrictions, recommended check
HFD	Anhydrous fluids (phosphate ester)	Possible restrictions, recommended check

 **The details of the various pressure fluids are provided for information only and do not replace in-house testing under the applicable operating conditions. In particular, the details cannot be interpreted as a guarantee of media compatibility. For detailed information about pressure fluids, see VDMA sheet 24317 and DIN 51524 51502. Special sealing materials are supplied depending on the fluid used. Please ask the factory if you are unsure.**

After a certain period of service, the hydraulic fluid must be replaced. The frequency of the change depends on the following:

- Type and grade of pressure fluid (ageing)
- Filtration
- Operating temperature and ambient conditions

1.10. Venting of hydraulic system

The hydraulic system must be vented on initial commissioning, after an oil change or after lines or valves are opened.

Air in the hydraulic system is highly detrimental to the behaviour of the control system and is therefore undesirable.

Venting takes place at the highest point of the pipe network. Loosen the vent screw slightly, allowing the air out along with a small amount of oil. When the escaping oil is no longer foaming, tighten the screw again. Then work through all functions in succession, in no-load operation with the lowest possible pressure, and with the full consumer range.

Then vent the system again. Make sure that any escaped oil is collected and disposed of correctly!

 **After venting, check the oil level in the tank and top up with oil if necessary.**

1.11. Flushing

 **With large central pressurised oil stations in particular, you are recommended to flush the long pipes by short circuiting the pressure and return lines. This prevents the dirt occurring during installation from being carried to the valve.**

1.12. Product support

If you require further support about the product, about order processing or about solutions to problems, please contact your relevant sales company.

2. General notes on safety

2.1. Use of operating instructions

 **We would again like to remind you that the commissioning and use of our product must be based on these operating instructions. They must**

- be followed in full at all times,
- be kept in close proximity to the installed product, and be accessible at all times,
- be passed on to any later owners,
- always be used in the version supplied.

The personnel whose job is to work with this product must have read the operating instructions – in particular the section entitled "General notes on safety" – before starting work. This specifically applies to personnel who will only work with the product occasionally (e.g. setting up, maintenance).

2.2. Compliance with other rules and instructions

Carry out transport and installation/repair activities only in accordance with the valid and applicable safety and accident prevention regulations issued by the trade associations.

The valve contains hydraulic oil. The normal local environmental protection requirements must

therefore be met when handling the product. The particular circumstances of each place of installation mean that instructions must be followed in order to install and use the product safely.



Any health and safety warnings attached to the product must be observed and must be maintained in a legible state.

2.3. Personnel requirements

The product may only be used, installed, removed, operated and maintained by specialist personnel. For the purposes of these instructions, a specialist is defined as someone who, on the basis of their education, expertise and professional experience, is able to correctly evaluate and carry out the tasks and duties assigned to him/her, and identify and correct potential hazards.

Skilled, semi-skilled or trained personnel may not use this product under their own responsibility unless they have the required specialist knowledge. Otherwise, they may only use the product under the constant supervision of a specialist person.

2.4. Use of the product

The product must only be used if it is perfect working order. Problems that may impair safety must be corrected.



This product is a safety component that may only be repaired by the manufacturer if it malfunctions.

If the safety components are repaired by the user, the manufacturer's warranty is invalidated because the manufacturer is demonstrably unable to ensure that the product is used as specified.

2.5. Limits of use

The product may only be operated within the specified limits of use. The relevant details can be found in "Technical data" (section 16).



The ambient conditions must be observed. Unauthorised temperatures, shocks, the effects of aggressive chemicals, radiation, unauthorised electromagnetic emissions may result in disruptions and failures. Observe the limits of operation set out in "Technical data" (section 16).



DCV valves with position control are not suitable for use in Ex areas (gas/dust).

2.6. Contaminations

The function and service life of the valve are heavily dependent on the purity and quality of the pressure fluid and depend upon the operating conditions of the hydraulic components.

Appropriate filters must be used and regular inspections of the medium must be carried out to prevent contamination of the pressure fluid. The permitted level of contamination is set out in the "Technical data".



Be aware of three important sources of contamination:

- Contaminations entering during installation
- Contaminations occurring during operation
- Dirt entering from the surroundings

3. Remaining risk

3.1. Allergic reactions

Hydraulic oil can cause allergic reactions on susceptible skin. This can be prevented by taking the precautions that are usual when handling mineral oil products and by using personal protective equipment.

3.2. Leaking plugs



Leaking plugs can cause a malfunction. That is why the plugs must be checked for leaks at the regular maintenance interval. Leaking plugs may constitute a safety hazard, so the valve must be returned to the manufacturer for repair.

3.3. Lightning



If electronic components are exposed to electromagnetic fields as a result of lightning, they must be checked to ensure they are still working perfectly. If there is a malfunction, the product must be returned to the manufacturer.

3.4. Temperature

The surface of our product may heat up in use.



The service temperatures may exceed the temperature threshold for burn injury, 70°C. Above this threshold, even brief contact with the surface may result in a burn.

The only way to consistently prevent burn injuries is to use personal protective equipment and to remain safety-conscious at all times.



If integrated electronics are exposed to a temperature above 80°C, they may malfunction.

3.5. Power failure



In a power failure the valve piston returns to the spring centred starting position. You must check whether this creates potential hazards when the system/machine is used.

3.6. Hydraulic

DCV are tested and approved with an even flow. If the flow becomes asymmetrical, the safety function of the valve may be compromised. You should therefore carry out tests before commissioning to verify that the valve is in good working order.

If the valve piston has been under pressure and stationary in the end position for an extended period, oil particles may cause the piston to seize. For this reason the valve should be actuated regularly.

3.7. Electrical connection for position control

The position control can be connected as normally closed or normally open. In principle, we recommend a normally closed connection, as this is the only way to ensure that position control works properly

4. Correct use

Our products are manufactured using state of the art technology and recognised safety procedures. The DCV valves are designed for mould closing devices in injection moulding machines according to the manufacturer's installation instructions (see

Installation instructions 8.1 and Position control 16.1).

According to section 1(2b) of accident prevention guidelines "Injection moulding machines" (VGB 7 ac) and section 5 of EN 201:1997 "Injection moulding machines. Safety requirements", the valves must be independently monitored by the control system of the injection moulding machine, such that if position control fails, a new machine cycle is prevented from starting.

5. Function

The DCV valves are devices that influence the direction of a flow. To do this, connections between the various ports are made or broken. Activating the solenoid or the hydraulic pilot causes the piston in the valve to move to the end position.

If the electrical signal is removed, the installed spring pushes the piston back to its starting position.

The purpose of the installed position control is to detect when the piston is in the starting position.

6. Transport

The low weight of the product means that no lifting equipment or transport aids are needed.

Our product leaves the factory in perfect working order, and appropriate packaging is used to protect it from damage.



The condition of the product on arrival is no longer under our control, so please check for transport damage/defects immediately after arrival.

Document the transport damage and immediately notify the carrier, the insurance company and the manufacturer.

Do not dispose of the packaging unless

- there is no transport damage
- the entire package contents have been removed from the packaging.



If the product has been damaged during transport, it must be exchanged for a new one.

When transporting the product within your premises, make sure it is kept in a safe position and protected in its original packaging until it is ready to use.

Note also the information in sections 1.4 (Warranty and liability), 2.1 (Use of operating instructions), 2.2 (Compliance with other rules and instructions), 2.3 (Personnel requirements), 3 (Remaining risk).

7. Storage

If the product needs to be temporarily stored, it must be protected from dirt, the weather, and damage. Each valve is tested with hydraulic oil in the factory, so that the internal components are protected from corrosion. However, this protection can only be guaranteed under the following conditions:

Storage time:	Conditions:
12 months	Stable air humidity 60% and stable temperature $>5^{\circ}\text{C}$ - $<25^{\circ}\text{C}$
6 months	Fluctuating air humidity and fluctuating temperature $>5^{\circ}\text{C}$ - $<35^{\circ}\text{C}$

The product is delivered with adequate corrosion protection, provided our recommendations for the ambient conditions are followed.

 **Storage outside or in maritime or tropical climates without appropriate packaging leads to corrosion and may make the product unusable.**

 **Make sure the product is stored so that no injuries can be caused by tipping or falling. In particular, make sure that the safety rules for high-bay racking are followed.**

8. Commissioning

After installing our product in a system/machine, make sure that the requirements of the Machinery Directive are met if applicable.

Access should be provided to the hydraulic diagram, the equipment list and the logic diagram for the system/machine.

 **The product must be checked for damage and missing parts (e.g. seals) before installation, especially in the area of the sealing surfaces and the safety devices. If the safety devices or sealing surfaces are damaged or are missing individual parts with relevance to the product's function, the product may not be used.**

Remove all transport securing devices, protective covers and packaging.

 **Check for foreign objects in the open hydraulic passages. Contaminations may impair operational reliability and shorten the service life.**

 **Make sure that the hydraulic system/machine is unpressurised before the product is installed.**

Use the nameplate to compare the valve type with the bill of materials/diagrams.

Take care during installation, to guarantee that all requirements for the safe use of the product are met.

Ensure that the sealing rings are seated correctly. Only use the fastening bolts specified by the manufacturer for installing the product (see "Technical data", section 16). The user should check again if additional components are added to the valve (e.g. sandwich plates)

Use the correct tool for installing the fastening bolts.

 **Install the fastening bolts to the torques specified by the manufacturer (see "Technical data", section 16). Tighten the bolts diagonally.**

 **If the seal of the position control system is damaged, there is a risk that the valve will not work properly. In this case, the valve must be returned to the manufacturer.**

 **The DCV valves must only be installed as indicated in ISO 4401.**



Before commissioning, the specialist personnel must verify that the entire hydraulic system has been installed correctly. Commissioning must be carried out with care, taking account of all safety regulations.



With piston 030 there is a brief connection from P to T in the transitional position. An external pilot oil supply or an integrated precharge valve must be used in order to guarantee reliable valve operation even at low flows.

If necessary, erect warning signs to prevent unintended operation.

Note also the information in sections 1.4 (Warranty and liability), 2.1 (Use of operating instructions), 2.2 (Compliance with other rules and instructions), 2.3 (Personnel requirements), 3 (Remaining risk).

8.1. Installation instructions DCV

Before installation, check the outer O-rings to ensure they are intact and complete. Damaged parts of O-rings may impair the function of the valve and must not be installed. Lifting and installation equipment should be used as necessary for installation.

After placing the valve on the mating surface, tighten all bolts diagonally and evenly in several passes, to the torque specified by the manufacturer. The first time the valve is pressurised, check the sealing surface for leaks.

8.2. Electrical connections

Before commissioning,

- all electrical connections must be made professionally, using suitable ducting,
- parts of the machine and individually installed components must be adequately earthed,
- all limit switches and control elements must be properly integrated with the control system.

8.3. Hydraulic requirements for pilot operated directional control valves

To guarantee that the main piston operates reliably at all times, the minimum pilot pressure must be provided. To achieve this, a suitable combination of flow and return arrangements must be selected for the pilot oil.

9. Operation



If any of the safety features of the product are not operational, the system/machine must be shut down immediately.



Do not carry out any activities that might jeopardise safety.

Note also the information in sections 1.4 (Warranty and liability), 2.1 (Use of operating instructions), 2.2 (Compliance with other rules and instructions), 2.3 (Personnel requirements), 3 (Remaining risk).

10. Troubleshooting

A systematic approach must always be used in the troubleshooting process. Begin by answering the following questions:

- Does anyone have practical experience of similar faults?
- Have any of the settings been changed in the system/machine?
- Was the system/machine in perfect working order before the fault occurred?

The following list contains the problems that are possible in our view:

Problem / Error message	Possible cause	Actions
Leakage at the valve	O-ring at the mating flange leaking or missing.	Shut down the system/machine immediately. Replace the O-ring.
	Plug, plunger tube or case leaking.	Shut down the system/machine immediately. Replace the valve with a new one of the same series.
Valve does not switch on	Valve not correctly wired.	Check the electrical connections.
	No electrical signal from general control system.	Check the control system.
	Defective coil.	Measure coil resistance. Replace defective coil.
	Piston jams.	Check the operating conditions. Check the torques of the fastening bolts. If the operating conditions and the torques are correct, return the valve to the manufacturer for inspection.
	No pilot oil pressure (pilot operated valves)	Check pilot oil pressure and delivery.
Valve does not switch off	Electrical control system for the coil not deactivated.	Check the control system.
	Operating conditions incorrect.	Check the operating conditions.
	Silting effect.	Check the purity of the medium – if necessary improve filtering and replace the medium. Actuate the valve periodically.
	Broken spring.	Return the valve to the manufacturer for inspection.
	Pilot oil discharge interrupted	Check pilot oil discharge and delivery.
Position control not supplying a correct signal.	The wiring is not connected correctly.	Check wiring.
	Power supply to position control outside permitted range.	Check the power supply.
	Temperature drift.	Check ambient temperature at the valve. Check the temperature of the medium at the valve.
	Position control incorrectly set	Return the valve to the manufacturer for inspection.

11. Modification

We define modification as the replacement of a defective valve with a new valve of the same series. In particular, it is not permitted to open the valve.



Make sure that the hydraulic system/machine is unpressurised before the product is installed/removed.

Note also the information in sections 1.4 (Warranty and liability), 2.1 (Use of operating instructions), 2.2 (Compliance with other rules and instructions), 2.3 (Personnel requirements), 3 (Remaining risk).

12. Service/maintenance

Regular maintenance is essential in prolonging the service life of the system/machine, and safeguards plant safety and the operational availability of all components.

Regular maintenance intervals must be adhered to, according to the cycles established for the user.



The minimum maintenance requirements for our products are visual inspections

- to check the integrity of the seal at position control
- to check for leaks
- and to check that the plugs are properly secured.



Make sure that the hydraulic system/machine is unpressurised before the product is installed/removed.



If the product is removed from the system/machine for maintenance work, the system/machine must be disabled so it cannot be switched on unexpectedly.



Before checking or removing electrical connections, make certain that the power supply has been disconnected and steps have been taken to ensure it cannot be reconnected unintentionally.

As part of servicing/maintenance, only the following items can be replaced with original Parker replacement parts:

- Accessible O-rings (sealing surfaces)
- Solenoid coils
- Plugs, provided they were included with the original product

Note also the information in sections 1.4 (Warranty and liability), 2.1 (Use of operating instructions), 2.2 (Compliance with other rules and instructions), 2.3 (Personnel requirements), 3 (Remaining risk).

13. Decommissioning



Make sure that the hydraulic system/machine is unpressurised before the product is removed.

Note also the information in sections 1.4 (Warranty and liability), 2.1 (Use of operating instructions), 2.2 (Compliance with other rules and instructions), 2.3 (Personnel requirements), 3 (Remaining risk).

14. Disposal



At the end of the service life of this product

- all escaping pressure fluids must be removed and disposed of properly
- any significant fluids remaining in the product must be removed and disposed of properly
- all materials must be segregated for recycling when they are removed and taken to a suitable recycling centre.

Please segregate the packaging material properly (e.g. paper, plastic).

None of the components of the product contain hazardous materials.



The normal local environmental protection laws must always be met when disposing of the product.

Note also the information in sections 1.4 (Warranty and liability), 2.1 (Use of operating instructions), 2.2 (Compliance with other rules and instructions), 2.3 (Personnel requirements), 3 (Remaining risk).

15. Other documentation**15.1. Other applicable standards / rules**

- 2006/42/EC
Machinery Directive
- 2006/95/EC
Low Voltage Directive
- ISO 4406:1999-12
Hydraulic fluid power - Fluids - Method for coding the level of contamination by solid particles
- ISO 4401:2005-07
Hydraulic valves; mounting surfaces and connecting plates
- EN 201:1997 / section 5
Rubber and plastics machines - Injection moulding machines - Safety requirements
- DIN EN 626-1:2008-09
Safety of machinery - Reduction of risks to health from hazardous substances emitted by machinery -
Part 1: Principles and specifications for machinery manufacturers
- DIN EN 60204-1; VDE 0113-1:2007-06
Safety of machinery – Electrical equipment of machines – Part 1: General requirements
- DIN EN 60529; VDE 0470-1:2000-09
Degrees of protection provided by enclosures (IP code)
- DIN EN 61000-4-2/3/4/6/8
Electromagnetic compatibility
- DIN 51524-1:2006-04
Pressure fluids - HLP hydraulic oils - Part 1: Minimum requirements
- DIN 51525-2:2006-04
Pressure fluids - HLP hydraulic oils - Part 2: Minimum requirements
- German Occupation Safety Ordinance (Betriebssicherheitsverordnung)
- German Labour Protection Act (Arbeitsschutzgesetz)

15.2. Declaration of Conformity**EC Declaration of Conformity / Translation from German**

2006/42/EC

**Parker Hannifin****Manufacturing Germany GmbH & Co. KG**Hydraulic Controls Division Europe
Gutenbergstrasse 38
41564 Kaarst, GermanyMr Günther Funk is authorised to compile the technical file.
For enquiries, see the company address.

Parker Hannifin Manufacturing Germany GmbH & Co. KG declares that the safety valves

Directly operated directional control valves NG6 with solenoid actuation and monitoring of starting position Code I4N or I5N
Type D1VW*-SC/D1DW*-SC**Directly operated directional control valves NG10 with solenoid actuation and monitoring of starting position Code I4N or I5N**
Type D3W*-SC/D3DW*-SC**Directly operated directional control valves NG10 with solenoid actuation and monitoring of starting position Code I4N, I5N or I6N**
Type D31DW*-SC**Directly operated directional control valves NG16 with solenoid actuation and monitoring of starting position Code I4N, I5N or I6N**
Type D41VW*-SC**Directly operated directional control valves NG25 with solenoid actuation and monitoring of starting position Code I4N, I5N or I6N**
Type D81VW*-SC/D91VW*-SC

fulfil all the relevant provisions of the

Machinery Directive 2006/42/EC

This conformity has been established on the basis of type testing by

Prüf- und Zertifizierungsstelle
Fachausschuss MHHW
Graf-Recke-Strasse 69
40239 Düsseldorf

(ID 0393)

Certificate no. MHHW 09061 (NG6), MHHW 09062 (NG10 - Directly operated).
MHHW 09063 (NG10 - Pilot operated), MHHW 09064 (NG16, NG25)

Harmonised standards applied:

EN 201:1997 / section 5 Rubber and plastics machines - Injection moulding machines - Safety requirements
DIN EN 60529:2000-09 Degrees of protection provided by enclosures (IP code)
DIN EN 61000-4-2/3/4/6/8 Electromagnetic compatibility

Place, Date: Kaarst, 01.07.2011

Signature:
The undersigned:
Hansgeorg Kolvenbach / Business Unit Manager Industrial Valves**Any unauthorised structural change or addition to the product may jeopardise****safety to an unacceptable degree. This would invalidate the declaration of conformity supplied with the product.**

16. Technical data

16.1. Position control switch



Technical data

Supply voltage range	18 ... 42VDC
Supply ripple	≤10%
No-load power consumption	≤30mA
Max. output current per channel, ohmic load	400mA
Min. output load per channel, ohmic load	100kOhm
Max. output drop at 0.2 A	≤1.1V
Max. output drop at 0.4 A	≤1.6V
Switching hysteresis	≤0.1mm
Ambient temperature range	0...50°C
Max. ambient field strength at 50 Hz	1200A/m
Protection class	IP 65
Socket	M12 to IEC 61076-2-101

The factory setting of the position control switch must not be changed.

Notes on installation

- Connections to the limit switch must be laid separately from mains connections, for example power supplies to motors or magnets, because inductive voltage peaks would otherwise pass via the supply network to the limit switch, which could be damaged even though a protection circuit is installed.
- A suitable DC power supply is required for the switch. The ripple of the power supply must not exceed 10%.
- Voltage spikes occurring when inductive loads are removed should be eliminated using a suitable protection circuit, for example flyback diodes.
- A built-in overload protection circuit suspends the switching function of the limit switch if an overload occurs. When the overload ends, the limit switch automatically resumes operation.
- The limit switch must not be installed close to AC consumers, e.g. AC solenoids, which may cause disruption. A minimum distance of 0.1 m must be observed in all cases.
- The product may only be operated in the conditions set out in the technical data.
- Connections must follow the connection list.

Connection Diagram

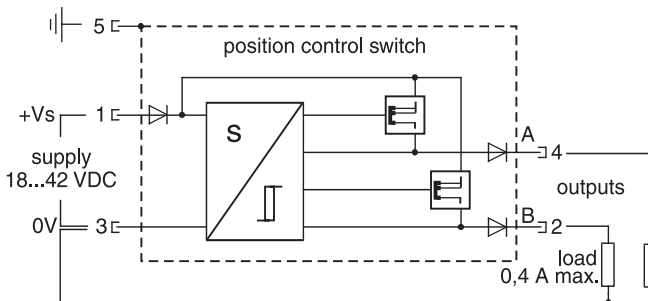

Note: If you need case drain values for DCV directional control valves for hydraulic mould closing devices in injection moulding machines, they are available from Parker (infohcd@parker.com).

Limit switch type ASEW001D10

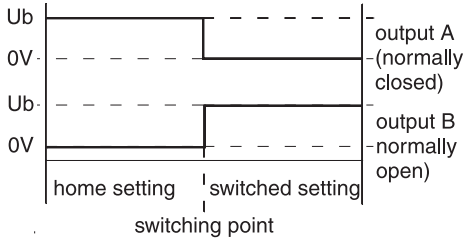

This switch is used to monitor **one** switching point. When the switching point is reached, exit A (port 4) closes, which corresponds to the normally closed type. Meanwhile, exit B (port 2) changes to the flow state, which corresponds to the normally open type.

Limit switch type ASEW001D12

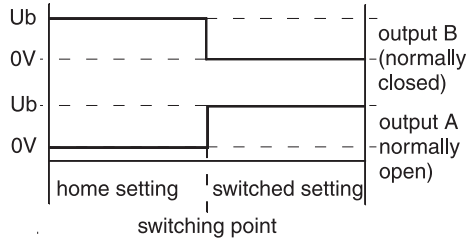

This switch is used to monitor **one** switching point. When the switching point is reached, exit B (port 2) closes, which corresponds to the normally closed type. Meanwhile, exit A (port 4) changes to the flow state, which corresponds to the normally open type.

Wirings

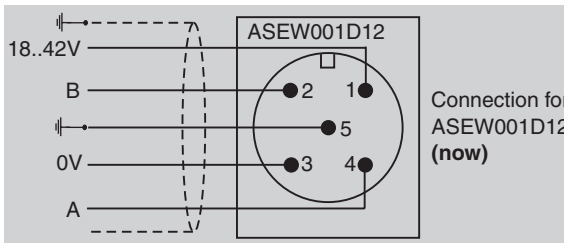

Installation

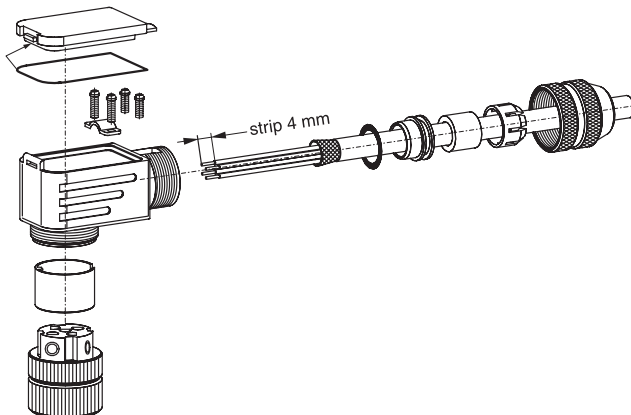

16.2. Series D1VW / D1DW**Technical data**

General					
Design	Directional spool valve				
Actuation	Solenoid				
Nominal size	DIN NG06 / CETOP 03 / NFPA D03				
Mounting interface	DIN 24340 A6 / ISO 4401 / CETOP RP 121-H / NFPA D03				
Mounting position	As desired, horizontal mounting preferred				
Ambient temperature	[°C]	0...+60			
Weight	[kg]	1.8 (1 solenoid)			
Hydraulic					
Max. operating pressure	[bar]	P, A B: 350 ; T: 210			
Fluid	Hydraulic oil according to DIN 51524				
Fluid temperature	[°C]	0...+70			
Viscosity permitted	[cSt] / [mm ² /s]	2.8...400			
Viscosity recommended	[cSt] / [mm ² /s]	30...80			
Max. contamination	ISO 4406 (1999); 18/16/13				
Flow max.	[l/min]	80			
Leakage at 50 bar	[ml/min]	Up to 10 per flow path, depending on piston			
Static / Dynamic					
Step response at 95%	[ms]	Energized: 32 ; De-energized: 40			
Electrical					
Duty cycle	100% ED; CAUTION: coil temperature up to 150 °C possible				
Max. switching frequency	[1/h]	15000			
Protection class	IP 65 to EN 60529 (plugged and mounted)				
	Code	K	J	U	G
Operating tolerance	[V]	12 V =	24 V =	98 V =	205 V =
Supply tolerance	[%]	±10	±10	±10	±10
Power consumption	[A]	2.72	1.29	0.33	0.15
Power consumption	[W]	32.7	31	31.9	30.2
Solenoid connection	Connector to EN 175301-803, solenoid identification to ISO 9461.				
Wiring min.	[mm ²]	3 x 1.5 recommended			
Wiring length max.	[m]	50 recommended			

Please note that with electrical connections the protective conductor (PE \downarrow) must be connected according to the relevant regulations.

16.3. Series D3W / D3DW**Technical data**

General					
Design	Directional spool valve				
Actuation	Solenoid				
Nominal size	DIN NG10 / CETOP 05 / NFPA D05				
Mounting interface	DIN 24340 A10 / ISO 4401 / CETOP RP 121-H / NFPA D05				
Mounting position	As desired, horizontal mounting preferred				
Ambient temperature	[°C]	0...+60			
Weight	[kg]	5.2			
Hydraulic					
Max. operating pressure	[bar]	P, A, B: 350; T: 210			
Fluid	Hydraulic oil according to DIN 51524				
Fluid temperature	[°C]	0...+70			
Viscosity permitted	[cSt] / [mm ² /s]	2.8...400			
Viscosity recommended	[cSt] / [mm ² /s]	30...80			
Max. contamination	ISO 4406 (1999); 18/16/13				
Flow max.	[l/min]	150			
Leakage at 50 bar	[ml/min]	Up to 20 per flow path, depending on piston			
Static / Dynamic					
Step response at 95%	Energized: 105; De-energized: 85				
Electrical					
Duty cycle	100% ED; CAUTION: coil temperature up to 150 °C possible				
Max. switching frequency	[1/h]	10000			
Protection class	IP 65 to EN 60529 (plugged and mounted)				
	Code	K	J	U	G
Supply voltage / ripple	[V]	12 V =	24 V =	98 V =	205 V =
Supply tolerance	[%]	±10	±10	±10	±10
Current consumption	Hold [A]	3	1.5	0.37	0.18
Power consumption	Hold [W]	36	36	36	36
Connector	Connector to EN 175301-803, solenoid identification to ISO 9461.				
Wiring min.	[mm ²]	3 x 1.5 recommended			
Wiring length max.	[m]	50 recommended			

Please note that with electrical connections the protective conductor (PE \perp) must be connected according to the relevant regulations.

16.4. Series D31DW

Technical data

General					
Design	Directional spool valve				
Actuation	Solenoid				
Series	D31				
Nominal size	NG10				
Weight (1/2 solenoids)	[kg] 6.0 / 6.6				
Mounting interface	DIN 24340 A10 ISO 4401 NFFA D05 CETOP RP 121-H				
Mounting position	As desired, horizontal mounting preferred				
Ambient temperature	[°C] 0...+60				
Hydraulic					
Max. operating pressure	[bar] Pilot drain internal: P, A, B, X: 350; T, Y: 105 Pilot drain external: P, A, B, T, X: 350; Y: 105				
Fluid	Hydraulic oil according to DIN 51524				
Fluid temperature	[°C] 0...+70				
Viscosity permitted	[cSt] / [mm²/s] 2.8...400				
Viscosity recommended	[cSt] / [mm²/s] 30...80				
Max. contamination	ISO 4406 (1999); 18/16/13				
Flow max.	[l/min] 150				
Leakage at 350 bar (per flow path)	[ml/min] to 100*				
*depending on piston					
Opening pressure of precharge valve	[bar] n.a.				
Min. pilot pressure	[bar] 5				
Static / Dynamic					
Step response at 95%	[ms] Energized / De-energized:				
DC solenoids	pilot pressure 50 bar	60 / 40			
	100 bar	55 / 40			
	250 bar	55 / 40			
	350 bar	55 / 40			
AC solenoids	pilot pressure 50 bar	40 / 30			
	100 bar	35 / 30			
	250 bar	35 / 30			
	350 bar	35 / 30			
Electrical					
Duty cycle	100% ED; CAUTION: coil temperature up to 150 °C possible				
Protection class	IP 65 to EN 60529 (plugged and mounted)				
	Code	K	J	U	G
Supply voltage / ripple	[V]	12 V =	24 V =	98 V =	205 V =
Supply tolerance	[%]	±10	±10	±10	±10
Power consumption	[A]	2.72	1.29	0.33	0.15
Power consumption	[W]	32.7	31	31.9	30.2
Solenoid connection		Connector to EN 175301-803, solenoid identification to ISO 9461.			
Wiring min.	[mm²]	3 x 1,5 recommended			
Wiring length max.	[m]	50 recommended			

Please note that with electrical connections the protective conductor (PE ↓) must be connected according to the relevant regulations.

16.5. Series D41VW

Technical data

General					
Design	Directional spool valve				
Actuation	Solenoid				
Series	D41				
Nominal size	NG16				
Weight (1/2 solenoids)	[kg] 9.7 / 10.3				
Mounting interface	DIN 24340 A16 ISO 4401 NFPA D07 CETOP RP 121-H				
Mounting position	As desired, horizontal mounting preferred				
Ambient temperature	[°C] 0...+60				
Hydraulic					
Max. operating pressure	[bar] Pilot drain internal: P, A, B, X: 350; T, Y: 105 Pilot drain external: P, A, B, T, X: 350; Y: 105				
Fluid	Hydraulic oil according to DIN 51524				
Fluid temperature	[°C] 0...+70				
Viscosity permitted	[cSt] / [mm ² /s] 2.8...400				
Viscosity recommended	[cSt] / [mm ² /s] 30...80				
Max. contamination	ISO 4406 (1999); 18/16/13				
Flow max.	[l/min] 300				
Leakage at 350 bar (per flow path)	[ml/min] to 200*				
*depending on piston					
Opening pressure of precharge valve	[bar] see p/Q diagram				
Min. pilot pressure	[bar] 5				
Static / Dynamic					
Step response at 95%	[ms] Energized / De-energized:				
DC solenoids	pilot pressure 50 bar	95 / 65			
	100 bar	75 / 65			
	250 bar	60 / 65			
	350 bar	60 / 65			
AC solenoids	pilot pressure 50 bar	75 / 55			
	100 bar	65 / 55			
	250 bar	40 / 55			
	350 bar	40 / 55			
Electrical					
Duty cycle	100% ED; CAUTION: coil temperature up to 150 °C possible				
Protection class	IP 65 to EN 60529 (plugged and mounted)				
	Code	K	J	U	G
Supply voltage / ripple	[V]	12 V =	24 V =	98 V =	205 V =
Supply tolerance	[%]	±10	±10	±10	±10
Power consumption	[A]	2.72	1.29	0.33	0.15
Power consumption	[W]	32.7	31	31.9	30.2
Solenoid connection		Connector to EN 175301-803, solenoid identification to ISO 9461.			
Wiring min.	[mm ²]	3 x 1,5 recommended			
Wiring length max.	[m]	50 recommended			

Please note that with electrical connections the protective conductor (PE ↓) must be connected according to the relevant regulations.

16.6. Series D81VW / D91VW**Technical data**

General	
Design	Directional spool valve
Actuation	Solenoid
Series	D81/D91
Nominal size	NG25
Weight (1/2 solenoids)	[kg] 17.9 / 18.6
Mounting interface	DIN 24340 A25 ISO 4401 NFFA D08 CETOP RP 121-H
Mounting position	As desired, horizontal mounting preferred
Ambient temperature	[°C] 0...+60
Hydraulic	
Max. operating pressure	[bar] Pilot drain internal: P, A, B, X: 350; T, Y: 105 Pilot drain external: P, A, B, T, X: 350; Y: 105
Fluid	Hydraulic oil according to DIN 51524
Fluid temperature	[°C] 0...+70
Viscosity permitted	[cSt] / [mm ² /s] 2.8...400
Viscosity recommended	[cSt] / [mm ² /s] 30...80
Max. contamination	ISO 4406 (1999); 18/16/13
Flow max.	[l/min] 700
Leakage at 350 bar (per flow path)	[ml/min] to 800*
	*depending on piston
Opening pressure of precharge valve	[bar] see p/Q diagram
Min. pilot pressure	[bar] 5
Static / Dynamic	
Step response at 95%	[ms] Energized / De-energized:
DC solenoids	pilot pressure 50 bar 150 / 170
	100 bar 110 / 170
	250 bar 90 / 170
	350 bar 85 / 170
AC solenoids	pilot pressure 50 bar 130 / 155
	100 bar 90 / 155
	250 bar 70 / 155
	350 bar 65 / 155
Electrical	
Duty cycle	100% ED; CAUTION: coil temperature up to 150 °C possible
Protection class	IP 65 to EN 60529 (plugged and mounted)
	Code
Supply voltage / ripple	[V] K J U G
Supply tolerance	[%] ±10 ±10 ±10 ±10
Power consumption	[A] 2.72 1.29 0.33 0.15
Power consumption	[W] 32.7 31 31.9 30.2
Solenoid connection	Connector to EN 175301-803, solenoid identification to ISO 9461.
Wiring min.	[mm ²] 3 x 1,5 recommended
Wiring length max.	[m] 50 recommended

Please note that with electrical connections the protective conductor (PE ↓) must be connected according to the relevant regulations.

DCV 1-662 UK.INDD CM

17. Dimensions

17.1. Series D1VW / D1DW

Connection to EN 175301-803, DC solenoid, with plug M12x1 *
Designs B, E, F

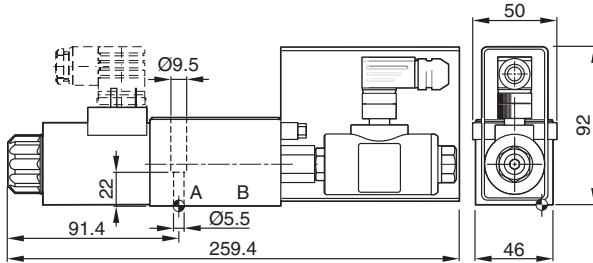

Designs H, K, M

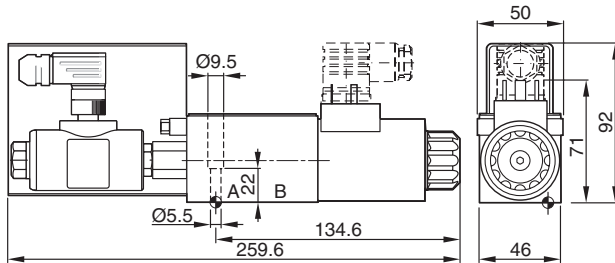

* Supplied with one plug M12 x 1 (see accessories, plug M12x1; Order no.: 5004109).

Surface finish	Kit			Kit
	BK375	4x M5x30 DIN 912 12.9	7.6 Nm ±15%	NBR: SK-D1VW-N-91 FPM: SK-D1VW-V-91

The space necessary to remove the plug per EN 175301-803, design type AF is at least 15 mm.
 The torque for the screw M3 of the plug has to be 0.5 to 0.6 Nm.

17.2. Series D3W / D3DW

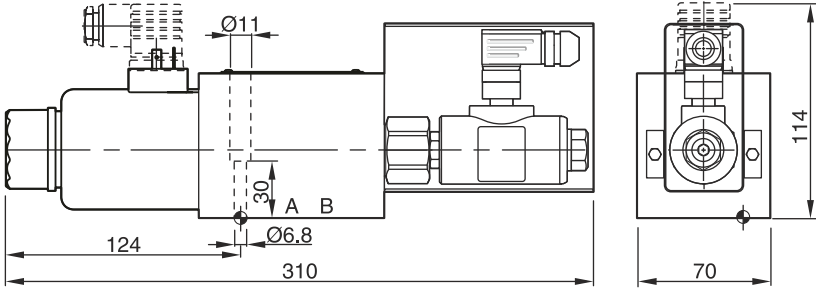

**Connection to EN 175301-803, DC solenoid, with connector M12x1*
 Designs B, E, F**

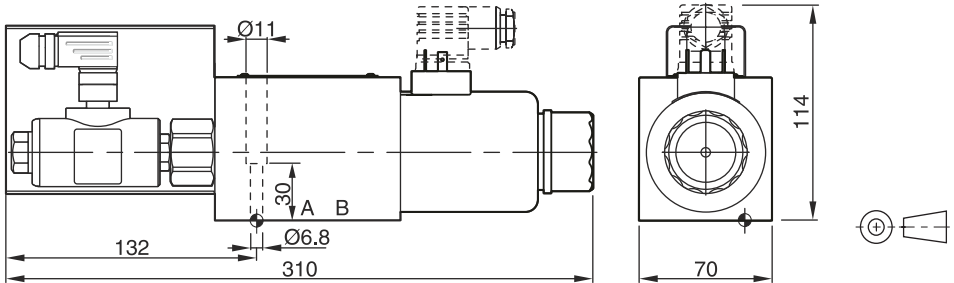

Designs H, K, M



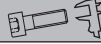

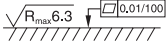

* Supplied with one plug M12 x 1 (see accessories, plug M12x1; Order no.: 5004109).

Surface finish	 Kit			 Kit
	BK385	4x M6x40 DIN 912 12.9	13.2 Nm ±15%	NBR: SK-D3W-30 FPM: SK-D3W-V30

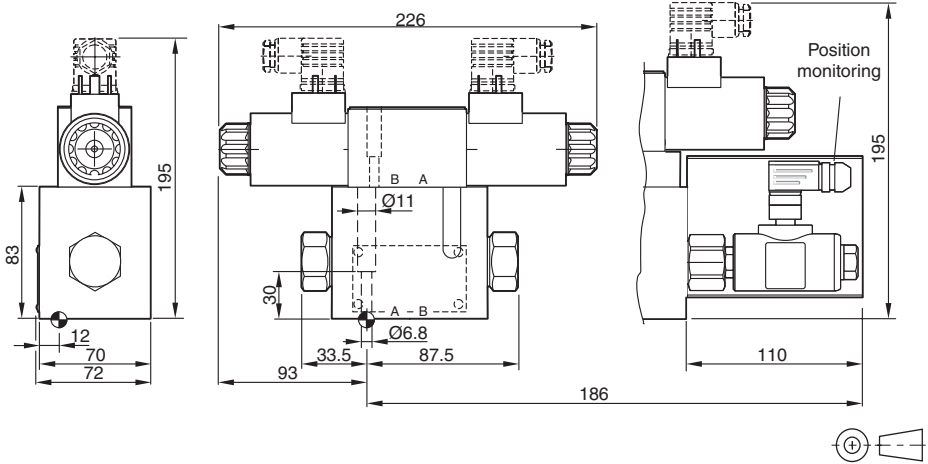
The space necessary to remove the plug per EN 175301-803, design type AF is at least 15 mm.
 The torque for the screw M3 of the plug has to be 0.5 to 0.6 Nm.





17.3. Series D31DW

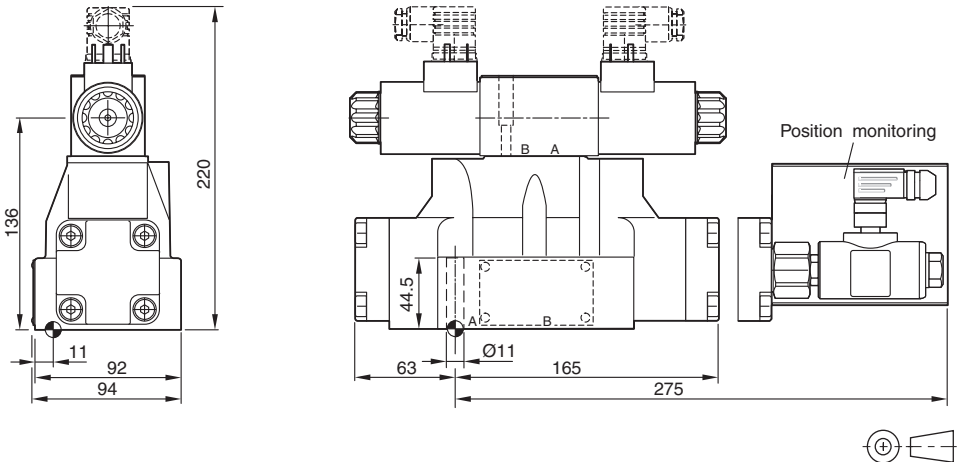

Surface finish	 Kit	 Kit	 Kit	 Kit
$\sqrt{R_{max}6,3}$ $\square_{0,01/100}$	BK385	4x M6x40 DIN 912 12.9	13.2 Nm ±15%	NBR: SK-D31DW-N-91 FPM: SK-D31DW-V-91





17.4. Series D41VW

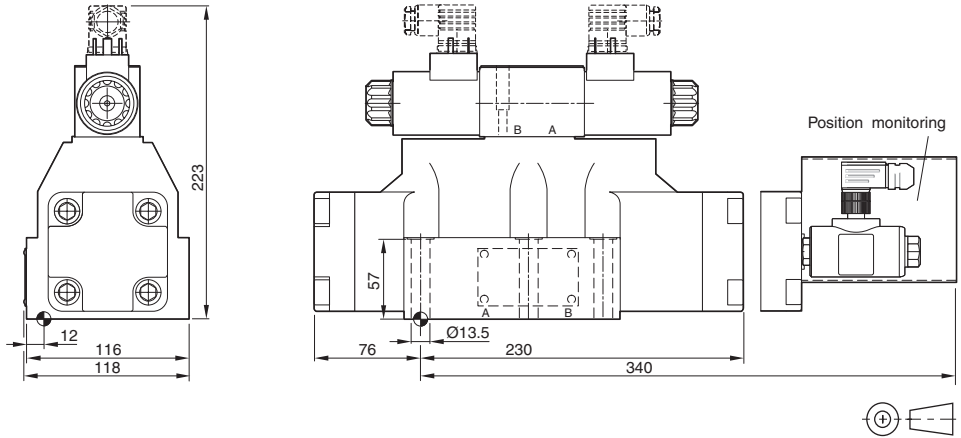

Surface finish	 Kit	 Kit	 Kit	 Kit
$\sqrt{R_{max}9,3}$ $\square_{0,01/100}$	BK320	4x M10x60 2x M6x55 DIN 912 12.9	63 Nm ±15% 13.2 Nm ±15%	NBR: SK-D3W-30 FPM: SK-D3W-V30

17.5. Series D81VW / D91VW



Surface finish	 Kit	 Kit	 Kit	 Kit
	BK360	6x M12x75 DIN 912 12.9	108 Nm ±15%	NBR: SK-D81VW-N-91 / SK-D91VW-N-91 FPM: SK-D81VW-V-91 / SK-D91VW-V-91

The space necessary to remove the plug per EN 175301-803, design type AF is at least 15 mm.
 The torque for the screw M3 of the plug has to be 0.5 to 0.6 Nm.

