

Features

- * Ultra small package: 1.0x0.6x0.5mm
- * Ultra low capacitance: 0.18pF typical
- * Ultra low leakage: nA level
- * Low operating voltage: $\pm 5V$
- * Low clamping voltage
- * 2-pin leadless package
- * Complies with following standards:
 - IEC 61000-4-2 (ESD) immunity test
 - Air discharge: $\pm 23kV$
 - Contact discharge: $\pm 20kV$
 - IEC61000-4-5 (Lightning) 3A (8/20 μs)
- * RoHS Compliant
- * Lead Finish: NiPdAu

Mechanical Characteristics

- * Package: DFN1006-2 (0402)
- * Lead Finish: Matte Tin
- * Case Material: "Green" Molding Compound.
- * Moisture Sensitivity: Level 3 per J-STD-020
- * Terminal Connections: See Diagram Below
- * Shipping Qty :10000/7Inch Tape & Reel

Applications

- * Smart phones
- * Display Ports
- * MDDI Ports
- * USB Ports
- * Digital Video Interface (DVI)
- * PCI Express and Serial SATA Ports

Dimensions and Pin Configuration

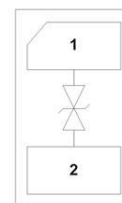
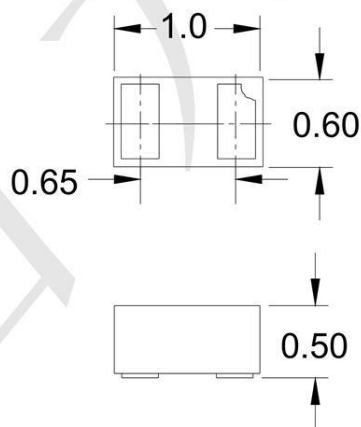

Marking:G Or B*

*** =date code**

Absolute Maximum Ratings (Tamb=25°C unless otherwise specified)

Parameter	Symbol	Value	Unit
Peak Pulse Power (8/20μs)	Ppk	60	W
Peak Pulse Current (8/20μs)	Ipp	3	A
ESD per IEC 61000-4-2 (Air)	VESD	±23	kV
ESD per IEC 61000-4-2 (Contact)		±20	
Operating Temperature Range	TJ	-55 to +125	°C
Storage Temperature Range	Tstg	-55 to +150	°C

Electrical Characteristics (TA=25°C unless otherwise specified)

Parameter	Symbol	Min	Typ	Max	Unit	Test Condition
Reverse Working Voltage	VRWM			5	V	
Breakdown Voltage	VBR	6	7.5	9	V	IT = 1mA
Reverse Leakage Current	IR			0.2	μA	VRWM = 5V
Clamping Voltage	VC			12	V	I _{PP} = 1A (8 x 20μs pulse)
Clamping Voltage	VC			19	V	I _{PP} = 3A (8 x 20μs pulse)
Junction Capacitance	CJ		0.18		pF	VR = 0V, f = 1MHz IO to IO

Typical Performance Characteristics ($T_A=25^\circ\text{C}$ unless otherwise Specified)

Fig1. 8/20 μs Pulse Waveform

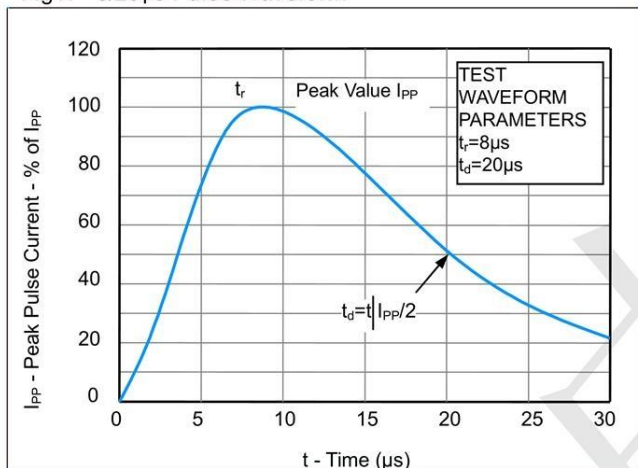

Fig2. ESD Pulse Waveform (according to IEC 61000-4-2)

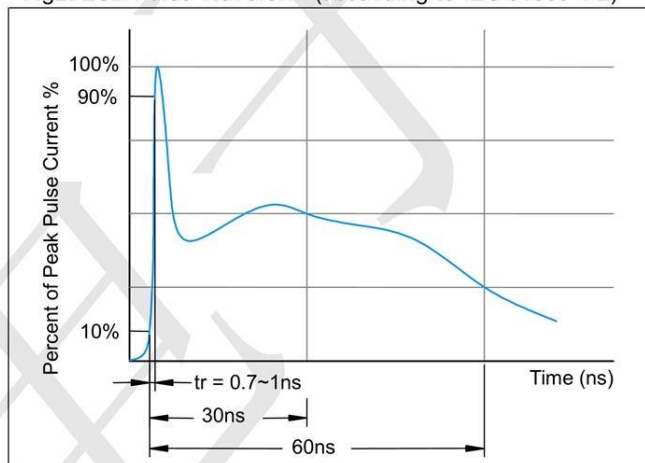
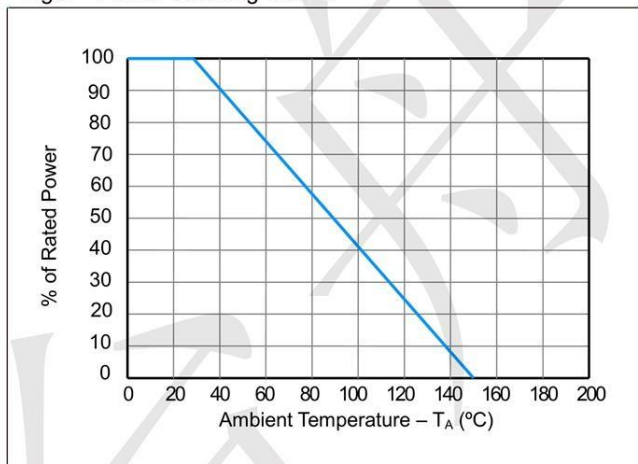
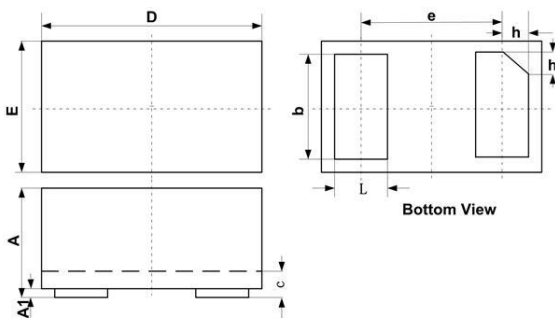

Fig3. Power Derating Curve



DFN1006-2 Package Outline Drawing (0402)



SYM	DIMENSIONS					
	MILLIMETERS			INCHES		
	MIN	NOM	MAX	MIN	NOM	MAX
A	0.45	0.50	0.55	0.018	0.020	0.022
A1	0.00	0.02	0.05	0.000	0.001	0.002
b	0.45	0.50	0.55	0.018	0.020	0.022
c	0.12	0.15	0.18	0.005	0.006	0.007
D	0.95	1.00	1.05	0.037	0.039	0.041
e	0.65 BSC			0.026 BSC		
E	0.55	0.60	0.65	0.022	0.024	0.026
L	0.20	0.25	0.30	0.008	0.010	0.012
h	0.07	0.12	0.17	0.003	0.005	0.007

Suggested Land Pattern

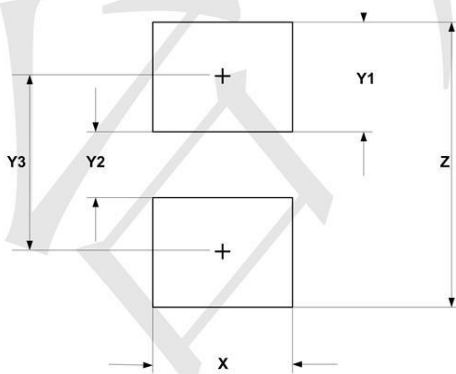

SYM	DIMENSIONS	
	MILLIMETERS	INCHES
X	0.60	0.024
Y1	0.50	0.020
Y2	0.30	0.012
Y3	0.80	0.032
Z	1.30	0.052