

# NSR0340V2

## Schottky Barrier Diode

Schottky barrier diodes are optimized for very low forward voltage drop and low leakage current and are used in a wide range of dc–dc converter, clamping and protection applications in portable devices. NSR0340V2 in a SOD–523 miniature package enables designers to meet the challenging task of achieving higher efficiency and meeting reduced space requirements.

### Features

- Very Low Forward Voltage Drop – 410 mV @ 100 mA
- Low Reverse Current – 0.5  $\mu$ A @ 25 V  $V_R$
- 250 mA of Continuous Forward Current
- Power Dissipation of 200 mW with Minimum Trace
- Very High Switching Speed
- Low Capacitance –  $C_T = 6$  pF
- This is a Pb–Free Device

### Typical Applications

- LCD and Keypad Backlighting
- Camera Photo Flash
- Buck and Boost dc–dc Converters
- Reverse Voltage and Current Protection
- Clamping & Protection

### Markets

- Mobile Handsets
- MP3 Players
- Digital Camera and Camcorders
- Notebook PCs and PDAs
- GPS

### MAXIMUM RATINGS

Rating	Symbol	Value	Unit
Reverse Voltage	$V_R$	40	Vdc
Forward Continuous Current (DC)	$I_F$	250	mA
Non–Repetitive Peak Forward Surge Current	$I_{FSM}$	1.0	A
ESD Rating: Human Body Model Machine Model	ESD	Class 2 Class A	

Stresses exceeding Maximum Ratings may damage the device. Maximum Ratings are stress ratings only. Functional operation above the Recommended Operating Conditions is not implied. Extended exposure to stresses above the Recommended Operating Conditions may affect device reliability.



**ON Semiconductor®**

<http://onsemi.com>

## 40 VOLT SCHOTTKY BARRIER DIODE

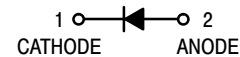

**SOD–523  
CASE 502**

### MARKING DIAGRAM



AD = Device Code  
M = Date Code\*  
▪ = Pb–Free Package

(Note: Microdot may be in either location)

\*Date Code orientation position may vary depending upon manufacturing location.

### ORDERING INFORMATION

Device	Package	Shipping†
NSR0340V2T1G	SOD–523 (Pb–Free)	3000 / Tape & Reel
NSR0340V2T5G	SOD–523 (Pb–Free)	8000 / Tape & Reel

†For information on tape and reel specifications, including part orientation and tape sizes, please refer to our Tape and Reel Packaging Specifications Brochure, BRD8011/D.

**THERMAL CHARACTERISTICS**

Characteristic	Symbol	Max	Unit
Thermal Resistance Junction-to-Ambient (Note 1) Total Power Dissipation @ $T_A = 25^\circ\text{C}$	$R_{\theta JA}$ $P_D$	600 200	$^\circ\text{C/W}$ mW
Thermal Resistance Junction-to-Ambient (Note 2) Total Power Dissipation @ $T_A = 25^\circ\text{C}$	$R_{\theta JA}$ $P_D$	300 400	$^\circ\text{C/W}$ mW
Junction and Storage Temperature Range	$T_J, T_{stg}$	-55 to +150	$^\circ\text{C}$

1. Mounted onto a 4 in square FR-4 board 10 mm sq. 1 oz. Cu 0.06" thick single-sided. Operating to steady state.
2. Mounted onto a 4 in square FR-4 board 1 in sq. 1 oz. Cu 0.06" thick single-sided. Operating to steady state.

**ELECTRICAL CHARACTERISTICS** ( $T_A = 25^\circ\text{C}$  unless otherwise noted)

Characteristic	Symbol	Min	Typ	Max	Unit
Reverse Leakage ( $V_R = 10\text{ V}$ ) ( $V_R = 25\text{ V}$ ) ( $V_R = 40\text{ V}$ )	$I_R$		0.2 0.5 1.5	1.0 3.0 6.0	$\mu\text{A}$
Forward Voltage ( $I_F = 10\text{ mA}$ ) ( $I_F = 100\text{ mA}$ ) ( $I_F = 200\text{ mA}$ )	$V_F$		310 410 470	350 450 510	mV
Total Capacitance ( $V_R = 10\text{ V}, f = 1\text{ MHz}$ )	CT		6.0		pF
Reverse Recovery Time ( $I_F = I_R = 10\text{ mA}, I_R = 1.0\text{ mA}$ )	$t_{rr}$		5.0		ns

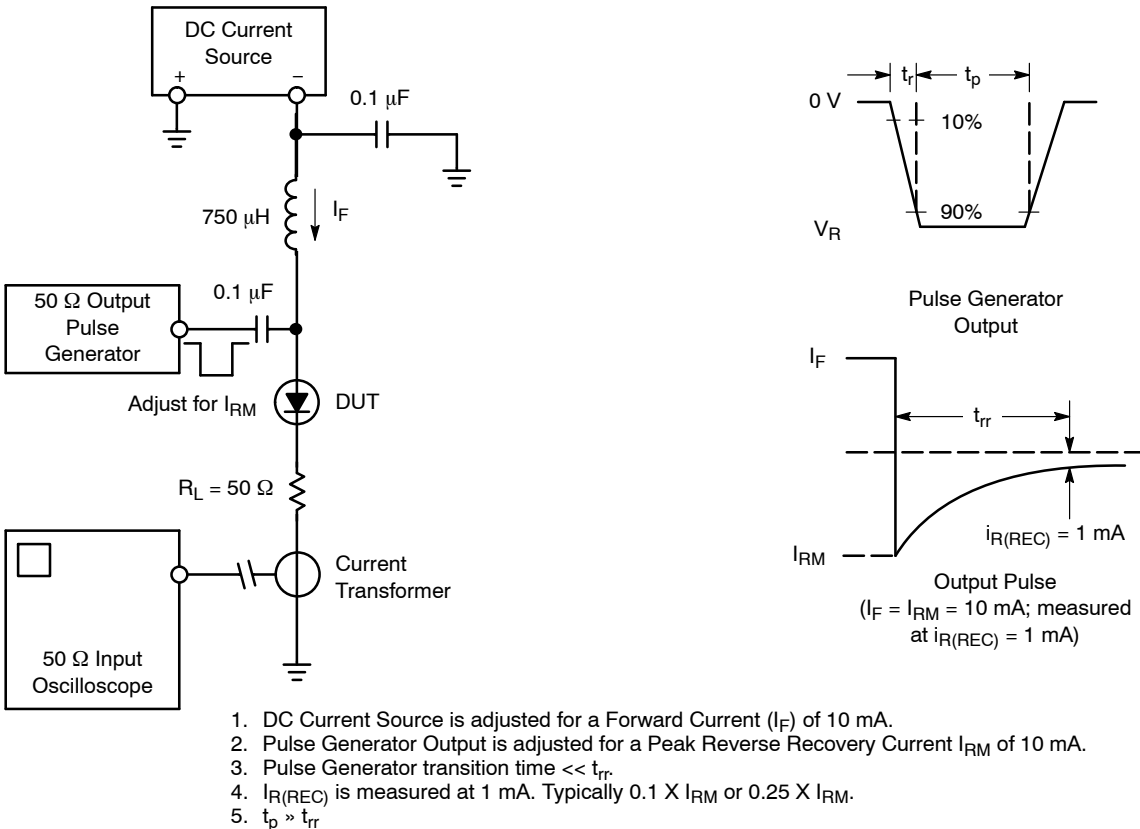

**Figure 1. Recovery Time Equivalent Test Circuit**

# NSR0340V2

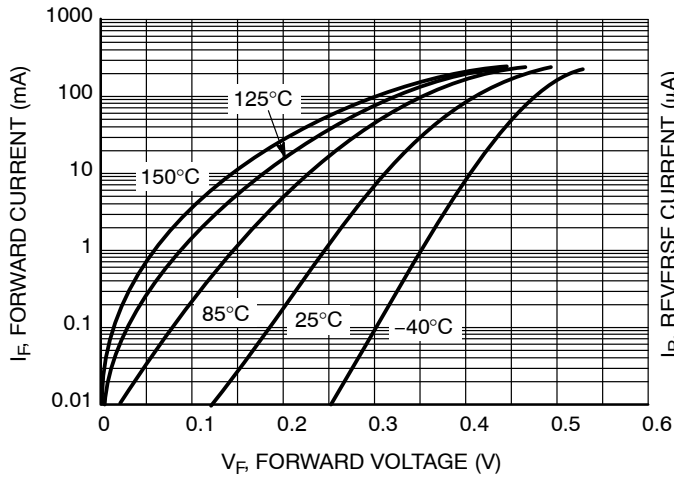

Figure 2. Forward Voltage

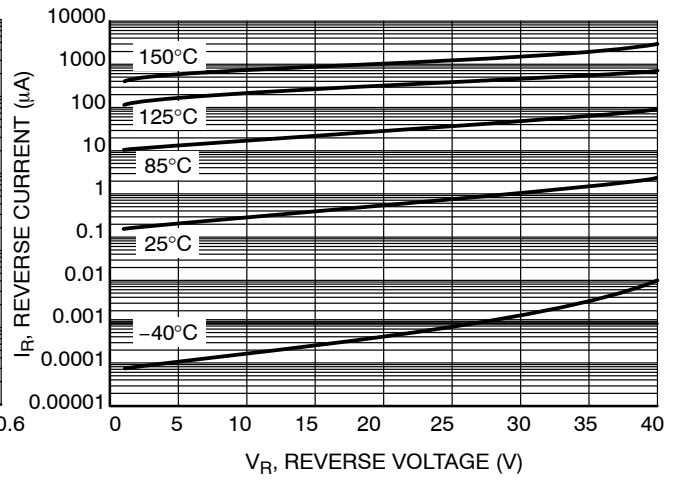

Figure 3. Leakage Current

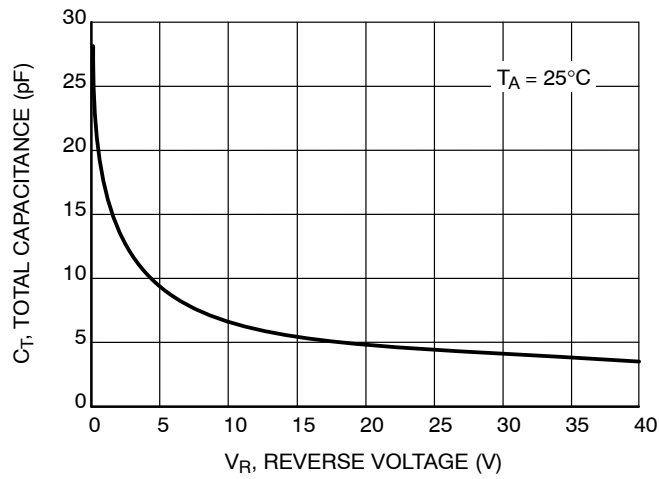
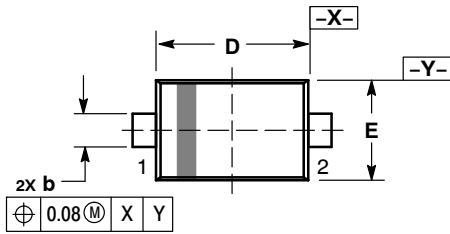

Figure 4. Total Capacitance

# NSR0340V2

## PACKAGE DIMENSIONS

SOD-523  
CASE 502  
ISSUE E



TOP VIEW

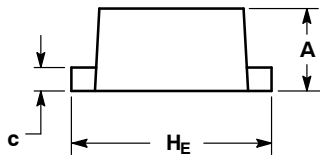

SIDE VIEW

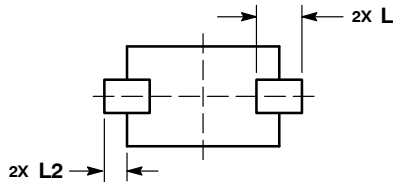

BOTTOM VIEW

NOTES:

1. DIMENSIONING AND TOLERANCING PER ASME Y14.5M, 1994.
2. CONTROLLING DIMENSION: MILLIMETERS.
3. MAXIMUM LEAD THICKNESS INCLUDES LEAD FINISH. MINIMUM LEAD THICKNESS IS THE MINIMUM THICKNESS OF BASE MATERIAL.
4. DIMENSIONS D AND E DO NOT INCLUDE MOLD FLASH, PROTRUSIONS, OR GATE BURRS.

DIM	MILLIMETERS		
	MIN	NOM	MAX
A	0.50	0.60	0.70
b	0.25	0.30	0.35
c	0.07	0.14	0.20
D	1.10	1.20	1.30
E	0.70	0.80	0.90
H E	1.50	1.60	1.70
L	0.30 REF		
L2	0.15	0.20	0.25

### RECOMMENDED SOLDERING FOOTPRINT\*

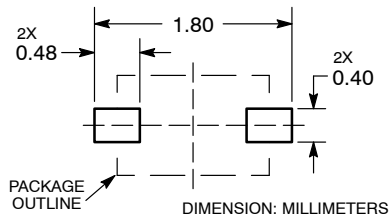

\*For additional information on our Pb-Free strategy and soldering details, please download the ON Semiconductor Soldering and Mounting Techniques Reference Manual, SOLDERRM/D.

ON Semiconductor and are registered trademarks of Semiconductor Components Industries, LLC (SCILLC). SCILLC owns the rights to a number of patents, trademarks, copyrights, trade secrets, and other intellectual property. A listing of SCILLC's product/patent coverage may be accessed at [www.onsemi.com/site/pdf/Patent-Marking.pdf](http://www.onsemi.com/site/pdf/Patent-Marking.pdf). SCILLC reserves the right to make changes without further notice to any products herein. SCILLC makes no warranty, representation or guarantee regarding the suitability of its products for any particular purpose, nor does SCILLC assume any liability arising out of the application or use of any product or circuit, and specifically disclaims any and all liability, including without limitation special, consequential or incidental damages. "Typical" parameters which may be provided in SCILLC data sheets and/or specifications can and do vary in different applications and actual performance may vary over time. All operating parameters, including "Typicals" must be validated for each customer application by customer's technical experts. SCILLC does not convey any license under its patent rights nor the rights of others. SCILLC products are not designed, intended, or authorized for use as components in systems intended for surgical implant into the body, or other applications intended to support or sustain life, or for any other application in which the failure of the SCILLC product could create a situation where personal injury or death may occur. Should Buyer purchase or use SCILLC products for any such unintended or unauthorized application, Buyer shall indemnify and hold SCILLC and its officers, employees, subsidiaries, affiliates, and distributors harmless against all claims, costs, damages, and expenses, and reasonable attorney fees arising out of, directly or indirectly, any claim of personal injury or death associated with such unintended or unauthorized use, even if such claim alleges that SCILLC was negligent regarding the design or manufacture of the part. SCILLC is an Equal Opportunity/Affirmative Action Employer. This literature is subject to all applicable copyright laws and is not for resale in any manner.

### PUBLICATION ORDERING INFORMATION

**LITERATURE FULFILLMENT:**  
Literature Distribution Center for ON Semiconductor  
P.O. Box 5163, Denver, Colorado 80217 USA  
**Phone:** 303-675-2175 or 800-344-3860 Toll Free USA/Canada  
**Fax:** 303-675-2176 or 800-344-3867 Toll Free USA/Canada  
**Email:** [orderlit@onsemi.com](mailto:orderlit@onsemi.com)

**N. American Technical Support:** 800-282-9855 Toll Free  
USA/Canada  
**Europe, Middle East and Africa Technical Support:**  
Phone: 421 33 790 2910  
**Japan Customer Focus Center**  
Phone: 81-3-5817-1050

**ON Semiconductor Website:** [www.onsemi.com](http://www.onsemi.com)  
**Order Literature:** <http://www.onsemi.com/orderlit>  
For additional information, please contact your local Sales Representative

# Mouser Electronics

Authorized Distributor

Click to View Pricing, Inventory, Delivery & Lifecycle Information:

[ON Semiconductor:](#)

[NSR0340V2T1G](#)