

# OPERATING INSTRUCTION

## 1000A AC CLAMP METER

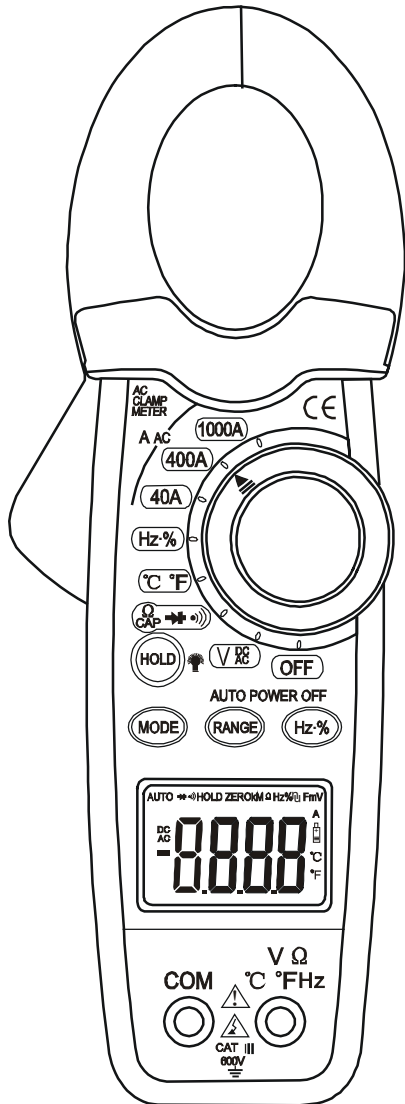

### Safety

#### International Safety Symbols



This symbol, adjacent to another symbol or terminal, indicates the user must refer to the manual for further information.



This symbol, adjacent to a terminal, indicates that, under normal use, hazardous voltages may be present



Double insulation

#### SAFETY NOTES

- Do not exceed the maximum allowable input range of any function
- Do not apply voltage to meter when resistance function is selected.
- Set the function switch OFF when the meter is not in use.

#### WARNINGS

- Set function switch to the appropriate position before measuring.
- When measuring volts do not switch to current/resistance modes.
- Do not measure current on a circuit whose voltage exceeds 240V.
- When changing ranges using the selector switch always disconnect the test leads from the circuit under test.
- Do not exceed the maximum rated input limits.

#### CAUTIONS

Improper use of this meter can cause damage, shock, injury or death. Read and understand this user manual before operating the meter.

Always remove the test leads before replacing the battery.

Inspect the condition of the test leads and the meter itself for any damage before operating the meter. Repair or replace any damage before use.

Use great care when making measurements if the voltages are greater than 25VAC rms or 35VDC. These voltages are considered a shock hazard.

Remove the battery if the meter is to be stored for long periods.

Always discharge capacitors and remove power from the device under test before performing Diode, Resistance or Continuity tests.

- Voltage checks on electrical outlets can be difficult and misleading because of the uncertainty of connection to the recessed electrical contacts. Other means should be used to ensure that the terminals are not "live".
- If the equipment is used in a manner not specified by the manufacturer, the protection provided by the equipment may be impaired.

Input Limits	
Function	Maximum Input
A AC	1000A
V DC, V AC	600V DC/AC
Resistance, Diode, Continuity, Capacitance, Frequency, Duty Cycle, Test	250V DC/AC
Temperature (°C/°F)	60V DC/24V AC

## Meter Description

1. Current clamp
2. Clamp trigger
3. Data Hold and Backlight button
4. Mode select button
5. LCD display
6. COM input jack
7. Rotary Function swith
8. Range select button
9. Hz/%duty button
10. V Ω °C/°F jack
11. Battery Cover

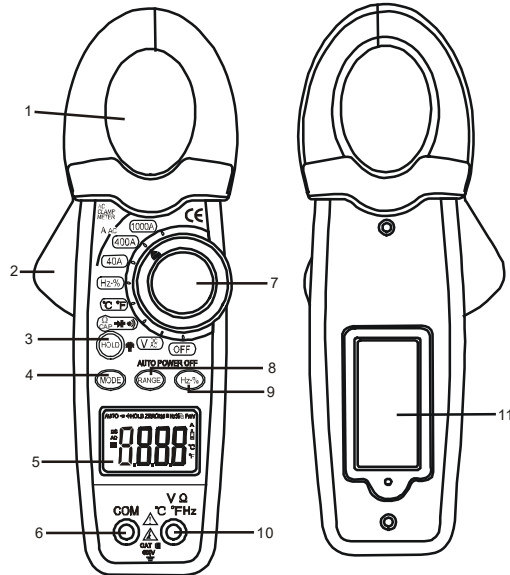

1. **AC DC** AC (alternating current) and DC (direct current)
2. **—** Minus sign
3. **8.8.8.8** 4000 count (0 to 3999) measurement reading
4. **AUTO** AutoRange mode
5. **→|—** Diode test mode
6. **•)))** Audible Continuity
7. **HOLD** Data Hold mode
8. **°C, °F, μ, m, V, A, K, M, Ω**, Units of measure list

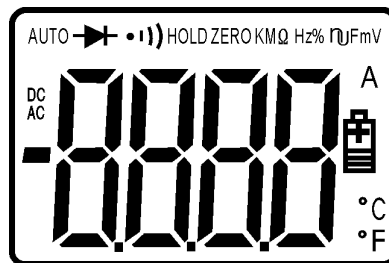

## Specifications

Function	Range & Resolution	Accuracy (% of reading)
AC Current	40.00 AAC	± (2.5% + 10 digits)
	400.0 AAC	± (2.5 % + 5 digits)
	1000 AAC	± (3.0 % + 4 digits)
DC Voltage	400.0 mVDC	± (0.8% + 3 digits)
	4.000 VDC	± (1.5% + 3 digits)
	40.00 VDC	
	400.0 VDC	
600 VDC	± (2.0% + 3 digits)	
AC Voltage	400.0 mVAC	± (0.8% + 20 digits)
	4.000 VAC	± (1.8% + 5 digits)
	40.00 VAC	
	400.0 VAC	
600 VAC	± (2.5% + 5 digits)	
Resistance	400.0 Ω	± (1.0% + 4 digits)
	4.000K Ω	± (1.5% + 2 digits)
	40.00K Ω	
	400.0K Ω	
	4.000M Ω	± (2.5% + 3 digits)
40.00M Ω	± (3.5% + 5 digits)	
Capacitance	40.00nF	±(5.0% reading + 100 digits)
	400.0nF	±(3.0% reading + 5 digits)
	4.000 μF	±(3.5% reading + 5 digits)
	40.00 μF	
	100.0 μF	±(5.0% reading + 5 digits)
Frequency	5.000Hz	±(1.5% reading + 5 digits)
	50.00Hz	±(1.2% reading + 2 digits) Sensitivity: 10Vrms min.
	500.0Hz	
	5.000kHz	
	50.00kHz	
	500.0kHz	±(1.5% reading + 10 digits)
5MHz		
10.00MHz		
Duty Cycle	0.5 to 99.0%	±(1.2% reading + 2 digits)
	Pulse width: 100μs - 100ms	
Temp (type-K) (probe ccuracy not included)	-50.0 to 400.0°C	±(3.0% reading + 5°C)
	400 to 1000 °C	
	-58.0 to 400.0°F	±(3.0% reading + 7°F)
	400 to 1832 °F	

Note: No Autoranging & 400mV AC Voltage Range

<b>Clamp size</b>	Opening 1.2" (30mm) approx
<b>Diode Test</b>	Test current of 0.3mA typical; Open circuit voltage 1.5V DC typical.
<b>Continuity Check</b>	Threshold <100Ω; Test current < 1mA
<b>Low Battery Indication</b>	"  " is displayed
<b>Overrange Indication</b>	"OL" is displayed
<b>Measurements Rate</b>	2 per second, nominal
<b>Input Impedance</b>	7.8MΩ (VDC and VAC)
<b>Display</b>	4000 counts LCD
<b>AC Current</b>	50/60Hz (AAC)
<b>AC Voltage bandwidth</b>	50/60Hz (VAC)
<b>Operating Temperature</b>	14 to 122°F (-10 to 50°C)
<b>Storage Temperature</b>	-14 to 140°F (-30 to 60°C)
<b>Relative Humidity</b>	90%(0°C to 30°C); 75%(30°C to 40°C); 45%(40°C to 50°C)
<b>Altitude</b>	Operating: 3000m; Storage 10,000m
<b>Over voltage</b>	Category III 600V
<b>Battery</b>	One "9V" Battery
<b>Auto OFF</b>	approx. 30 minutes
<b>Dimensions/Weight</b>	229x80x49mm/303g
<b>Safety</b>	For indoor use and in accordance with Overvoltage Category II, Pollution Degree 2. Category II includes local level, appliance, portable equipment, etc., with transient overvoltages less than Overvoltage Cat. III

## Operation

**NOTICES:** Read and understand all **warning** and **precaution** statements listed in the safety section of this operation manual prior to using this meter. Set the function select switch to the OFF position when the meter is not in use.

### AC Current Measurements

**WARNING:** Ensure that the test leads are disconnected from the meter before making current clamp measurements.

1. Set the Function switch to the **1000A or 400A or 40A** range. If the range of the measured is not known, select the higher range first then move to the lower range if necessary.
2. Press the trigger to open jaw. Fully enclose one conductor to be measured.
3. The clamp meter LCD will display the reading.

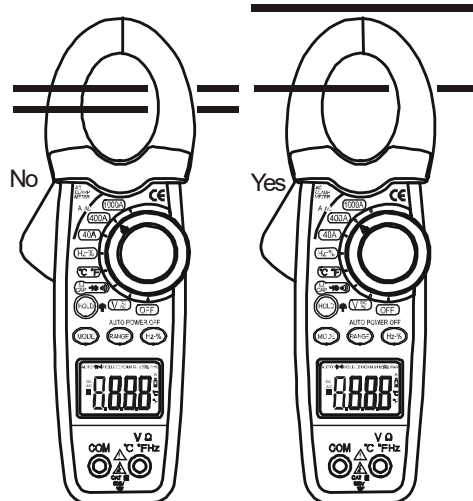

### DC/AC Voltage Measurements



5

1. Insert the black test lead into the negative **COM** terminal and the red test lead into the positive **V** terminal.
2. Set the function switch to the V position.
3. Select AC or DC with the **MODE** button.
4. Connect the test leads in parallel to the circuit under test.
5. Read the voltage measurement on the LCD display.

### Resistance and Continuity Measurements

1. Insert the black test lead into the negative **COM** terminal and the red test lead into the positive terminal.
2. Set the function switch to the  Ω position.
3. Use the multifunction **MODE** button to select resistance.
4. Touch the test probe tips across the circuit or component under test. It is best to disconnect one side of the device under test so the rest of the circuit will not interfere with the resistance reading.
5. For Resistance tests, read the resistance on the LCD display.
6. For Continuity tests, if the resistance is < 100Ω, a tone will sound.

### Diode Measurements

1. Insert the black test lead banana plug into the negative **COM** jack and the red test lead banana plug into the positive diode jack.
2. Turn the rotary switch to the  position.
3. Press the **MODE** button until " " appears in the display.
4. Touch the test probes to the diode under test. Forward voltage will indicate 0.4V to 0.7V. Reverse voltage will indicate "OL". Shorted devices will indicate near 0mV and an open device will indicate "OL" in both polarities.

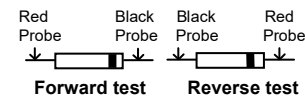

### Capacitance Measurements

**WARNING:** To avoid electric shock, disconnect power to the unit under test and discharge all capacitors before taking any capacitance measurements. Remove the batteries and unplug the line cords.

1. Set the rotary function switch to the cap position.
2. Insert the black test lead banana plug into the negative (**COM**) jack. Insert the red test lead banana plug into the positive (**V**) jack.
3. Touch the test leads to the capacitor to be tested.
4. Read the capacitance value in the display

### Frequency or % duty cycle measurements

1. Set the rotary function switch to the “**Hz/%**” position.
2. Insert the black lead banana plug into the negative **COM** jack and the red test lead banana plug into the positive **V** jack.
3. Select Hz or % duty with the **Hz/%** button.
4. Touch the test probe tips to the circuit under test.
5. Read the frequency on the display.

### Temperature Measurements

**WARNING:** To avoid electric shock, disconnect both test probes from any source of voltage before making a temperature measurement.

1. Set the function switch to **TEMP**.
2. Insert the Temperature Probe into the negative (**COM**) and the V jacks, making sure to observe the correct polarity.
3. Select °C or °F with the **MODE** button.
4. Touch the Temperature Probe head to the part whose temperature you wish to measure. Keep the probe touching the part under test until the reading stabilizes (about 30 seconds).
5. Read the temperature in the display. The digital reading will indicate the proper decimal point and value.

**WARNING:** To avoid electric shock, be sure the thermocouple has been removed before changing to another measurement function

### Data Hold and Backlight

To freeze the LCD meter reading, press the data hold button. The data hold button is located on the left side of the meter (top button). While data hold is active, the **HOLD** display icon appears on the LCD. Press the data hold button again to return to normal operation.

**Note:** The HOLD feature will activate when the Backlight is turned on. Press the HOLD key again to exit Hold.

The backlight function illuminates the display and is used when the ambient light is too low to permit viewing of the displayed readings.

Press the  (HOLD) button for one second to turn the backlight on and press the button a second time to turn the backlight off.

### Manual Ranging

The meter turns on in the autoranging mode. Press the **Range** button to go to manual ranging. Each press of the range button will step to the next range as indicated by the units and decimal point location. Press and hold the **Range** button for two seconds to return to autoranging. Manual ranging does not function in the AC Current, Diode and Continuity check functions

### Battery Replacement

1. Remove the one rear Phillips head screw
2. Open the battery compartment
3. Replace the Requires one “9V” battery (NEDA1604, 6F22 006P)
4. Re-assemble the meter