

CDBC5150-HF Thru. CDBC5200-HF

Reverse Voltage: 150 to 200 Volts

Forward Current: 5.0 Amp

RoHS Device

Halogen Free

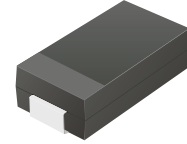

Features

- Low Profile surface mount applications in order to optimize board space.
- Low power loss, high efficiency.
- High current capability, low forward voltage drop.
- High surge capability.
- Guardring for overvoltage protection.
- Ultra high-speed switching.
- Silicon epitaxial planar chip, metal silicon junction.

Mechanical data

- Epoxy: UL94-V0 rate flame retardant.
- Case: Molded plastic, DO-214AB / SMC
- Terminals: solderable per MIL-STD-750, method 2026.
- Polarity: Indicated by cathode band.
- weight: 0.226 grams

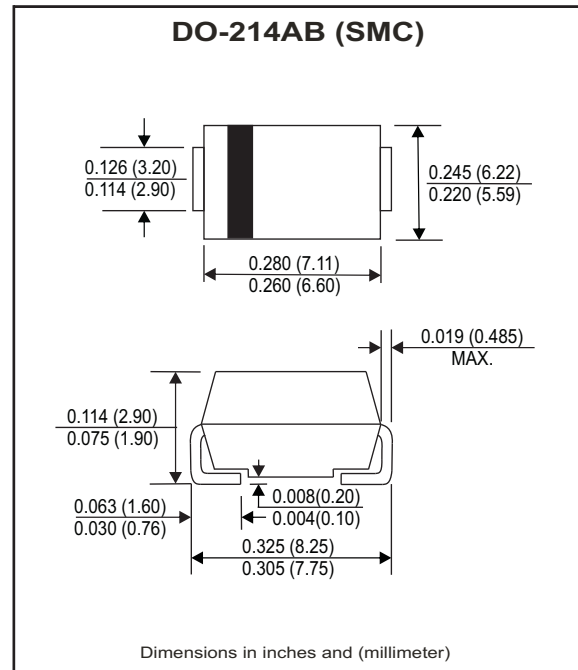

Maximum Ratings and Electrical Characteristics

Ratings at $T_a=25^\circ\text{C}$ unless otherwise noted.
 Single phase, half wave, 60Hz, resistive or inductive loaded.
 For capacitive load, derate current by 20% .

Parameter	Symbol	CDBC 5150-HF	CDBC 5200-HF	Units
Max. repetitive peak reverse voltage	V_{RRM}	150	200	V
Max. DC blocking voltage	V_{DC}	150	200	V
Max. RMS voltage	V_{RMS}	105	140	V
Max. instantaneous forward voltage @ 5.0A, $T_A=25^\circ\text{C}$	V_F	0.87	0.90	V
Operating Temperature	T_J	-50 to +175		$^\circ\text{C}$

Parameter	Conditions	Symbol	MIN.	TYP.	MAX.	Units
Forward rectified current	see Fig.1	I_o			5.0	A
Forward surge current	8.3ms single half sine-wave superimposed on rate load (JEDEC method)	I_{FSM}			125	A
Reverse Current	$V_R = V_{RRM}$ $T_A=25^\circ\text{C}$	I_R			0.5	mA
	$V_R = V_{RRM}$ $T_A=100^\circ\text{C}$	I_R			20	mA
Thermal Resistance	Junction to ambient	$R_{\theta JA}$		24		$^\circ\text{C}/\text{W}$
Diode Junction capacitance	f=1MHz and applied 4V DC reverse Voltage	C_J		380		pF
Storage temperature		T_{STG}	-50		+175	$^\circ\text{C}$

RATING AND CHARACTERISTIC CURVES (CDBC5150-HF thru. CDBC5200-HF)

Fig.1 - Typical Forward Current Derating Curve

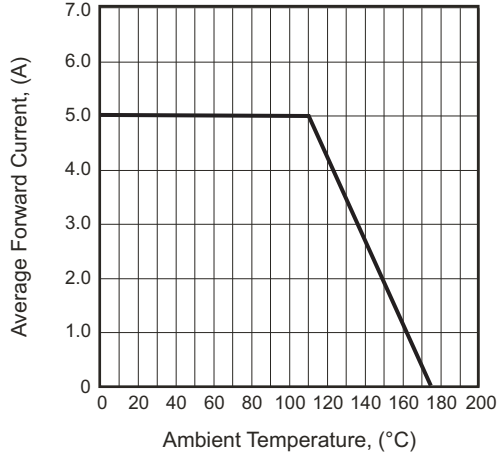

Fig.2 - Typical Forward Characteristics

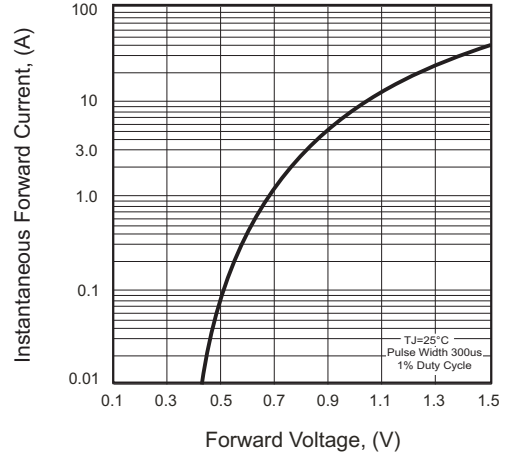

Fig.3 - Maximum Non-repetitive Forward Surge Current

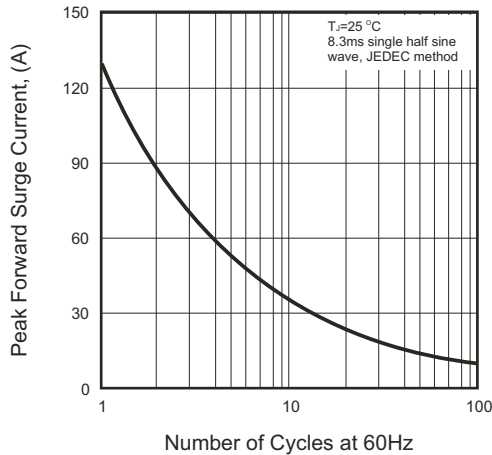

Fig.4 - Typical Junction Capacitance

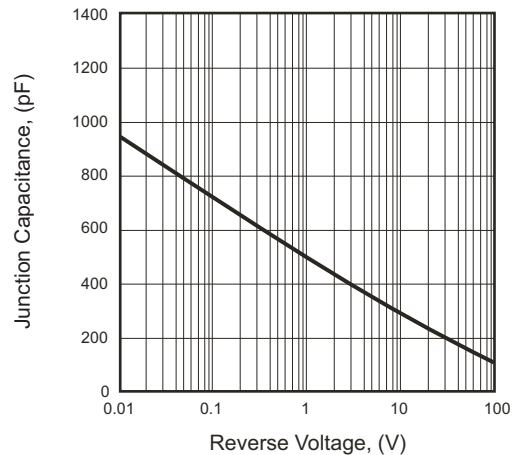
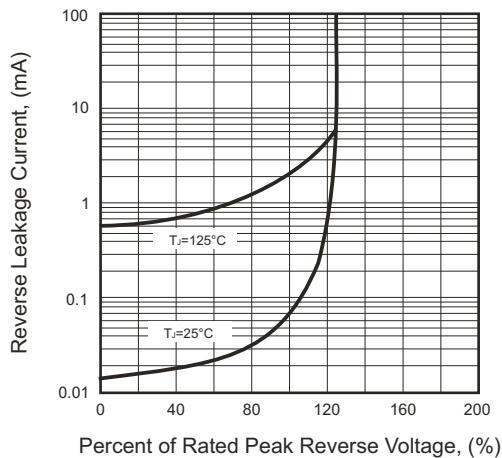
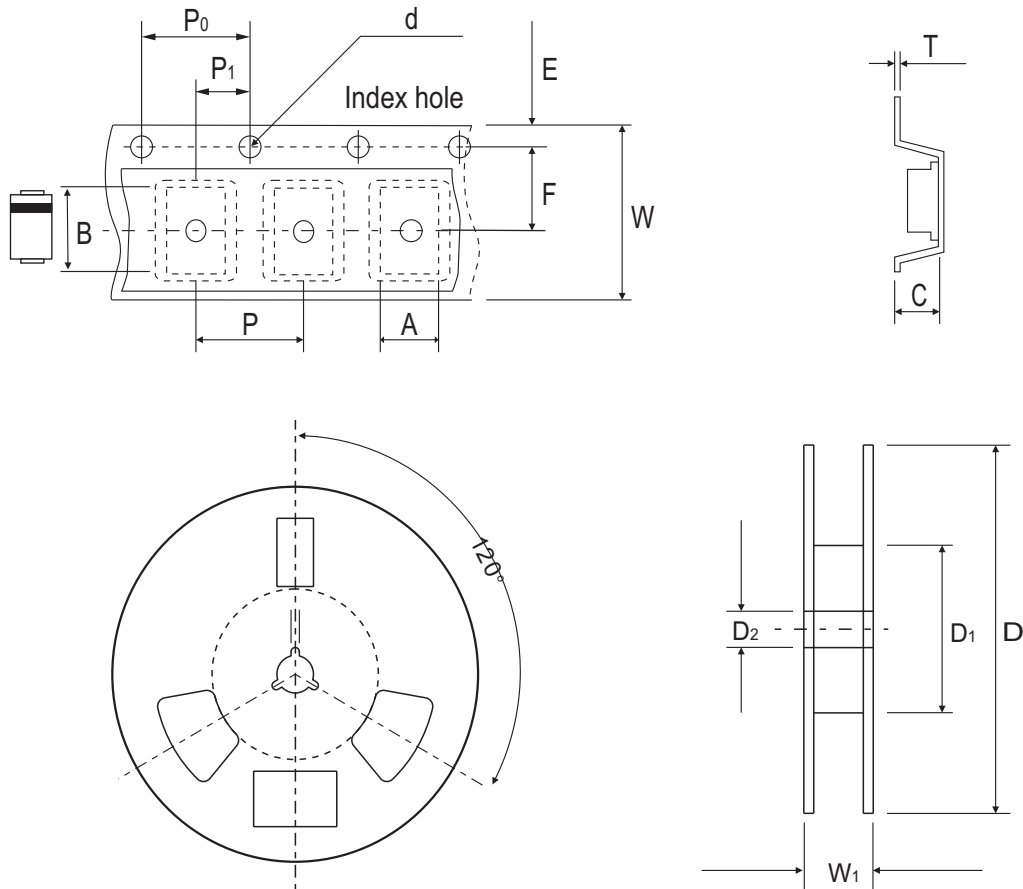

Fig.5 - Typical Reverse Characteristics



Reel Taping Specification



DO-214AB (SMC)	SYMBOL	A	B	C	d	D	D1	D2
	(mm)	6.30 ± 0.10	8.60 ± 0.10	2.90 ± 0.10	1.50 ± 0.10	330 ± 2.00	50.0 MIN.	13.50 ± 0.50
	(inch)	0.248 ± 0.004	0.339 ± 0.004	0.114 ± 0.004	0.059 ± 0.004	12.99 ± 0.079	1.969 MIN.	0.531 ± 0.020

DO-214AB (SMC)	SYMBOL	E	F	P	P0	P1	T	W	W1
	(mm)	1.75 ± 0.10	7.50 ± 0.10	8.00 ± 0.10	4.00 ± 0.10	2.00 ± 0.10	0.60 ± 0.10	16.00 ± 0.30	22.40 ± 1.00
	(inch)	0.069 ± 0.004	0.295 ± 0.004	0.315 ± 0.004	0.157 ± 0.004	0.079 ± 0.004	0.236 ± 0.004	0.630 ± 0.012	0.882 ± 0.039

Marking Code

Part Number	Marking Code
CDBC5150-HF	SK515
CDBC5200-HF	SK520

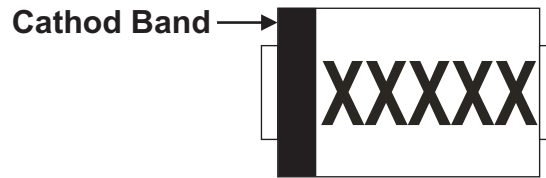

XXXXXX = Product type marking code

Suggested PAD Layout

SIZE	DO-214AB (SMC)	
	(mm)	(inch)
A	6.90	0.272
B	2.50	0.098
C	3.30	0.130
D	9.40	0.370
E	4.40	0.173

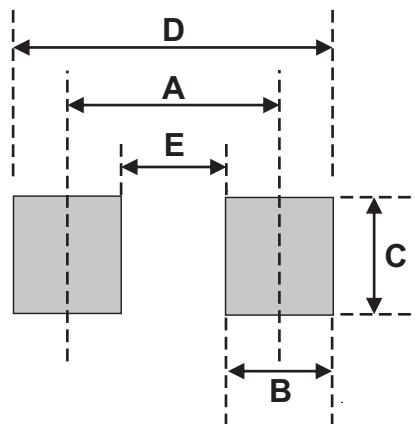

Standard Packaging

Case Type	REEL PACK	
	REEL (pcs)	Reel Size (inch)
DO-214AB (SMC)	3,000	13

Mouser Electronics

Authorized Distributor

Click to View Pricing, Inventory, Delivery & Lifecycle Information:

[Comchip Technology:](#)

[CDBC5200-HF](#)