

HCP0704

High current power inductors

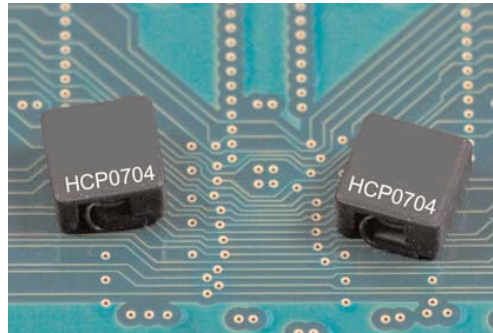

Product features

- 6.8 x 6.8 x 4.2 mm surface mount package
- Iron powder core material
- Magnetically shielded, low EMI
- High temperature core material eliminates thermal aging issues
- High current carrying capacity, low core losses
- Tight DCR tolerance for sensing circuits
- Inductance range from 0.40 μ H to 4.7 μ H
- Current range from 5.0 A to 27 A
- Frequency range up to 2 MHz
- Halogen free, lead free, RoHS compliant

Applications

- Voltage Regulator Module (VRM)
- Multi-phase regulators
- Desktop and servers
- Base station equipment
- Notebook and laptop regulators
- Data networking and storage systems
- Point-of-load modules (POL)
- Battery power systems
- DCR sensing circuits

Environmental Data

- Storage temperature range (Component): -40 °C to +155 °C
- Operating temperature range: -40 °C to +155 °C (ambient plus self-temperature rise)
- Solder reflow temperature: J-STD-020 (latest revision) compliant



Product Specifications

Part Number ⁶	OCL ¹ ± 25% (μH)	FLL ² Min. (μH)	I _{rms} ³ (A)	I _{sat} ⁴ @ +25 °C (A)	DCR (mΩ) @ +20 °C	K-factor ⁵
HCP0704-R40-R	0.40	0.28	17	27	3.2 ±10%	383.1
HCP0704-R60-R	0.60	0.42	14	21	4.5 ±10%	313.5
HCP0704-1R0-R	1.00	0.7	12	17	6.2 ±10%	265.3
HCP0704-1R8-R	1.80	1.26	8.5	13	11.0 ±10%	202.8
HCP0704-2R3-R	2.30	1.56	7.5	11.5	16.5 ±10%	164.2
HCP0704-3R3-R	3.30	2.31	6.0	9.5	25.0 ±10%	149.9
HCP0704-4R7-R	4.70	3.29	5.0	8.0	29.5 ±10%	127.7

1 OCL¹: Open Circuit Inductance (OCL) Test Parameters: 100 kHz, 0.10 V_{rms}, 0.0 Adc

2 FLL²: Full Load Inductance (FLL) Test Parameters: 100 kHz, 0.1 V_{rms}, I_{sat}¹

3 I_{rms}³: DC current for an approximate temperature rise of 40 °C without core loss. Derating

^{is} necessary for AC currents. PCB pad layout, trace thickness and width, air-flow and proximity of other heat generating components will affect the temperature rise. It is recommended the part temperature not exceed +125 °C under worst case operating conditions verified in the end application.

4 I_{sat}⁴: Peak current for approximately 20% rolloff at +25 °C.

5 K-factor: Used to determine B_{p-p} for core loss (see graph). B_{p-p} = K * L * ΔI : (Gauss), K: (K-factor from table), L: (inductance in μH), ΔI (peak-to-peak ripple current in amps).

6 Part Number Definition: HCP0704-xxx-R

- HCP0704 = Product code and size
- xxx= Inductance value in μH, R = decimal point. If no "R" is present, then third character = # of zeros
- "R" suffix = RoHS compliant

Dimensions (mm)

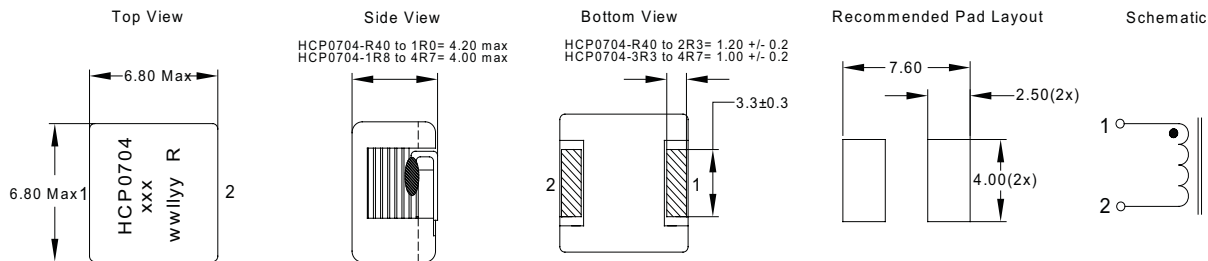

The nominal DCR test point is in the middle of the terminal

Part Marking: HCP0704 xxx = Inductance value in μH. (R = Decimal point). If no "R" is present, then last character is # of zeros wwlyy = Date code R = Revision level

Do not route traces or vias underneath the inductor

Packaging information (mm)

Supplied in tape and reel packaging, 1000 parts per 13" diameter reel.

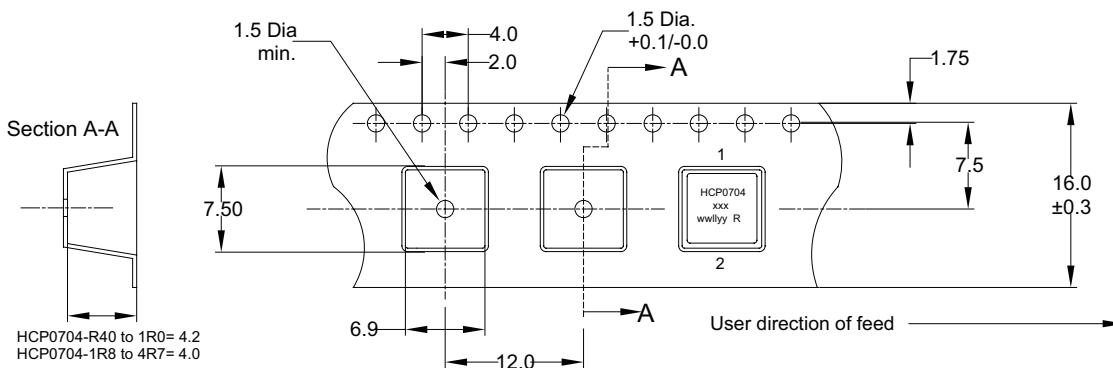

Temperature rise vs. total loss

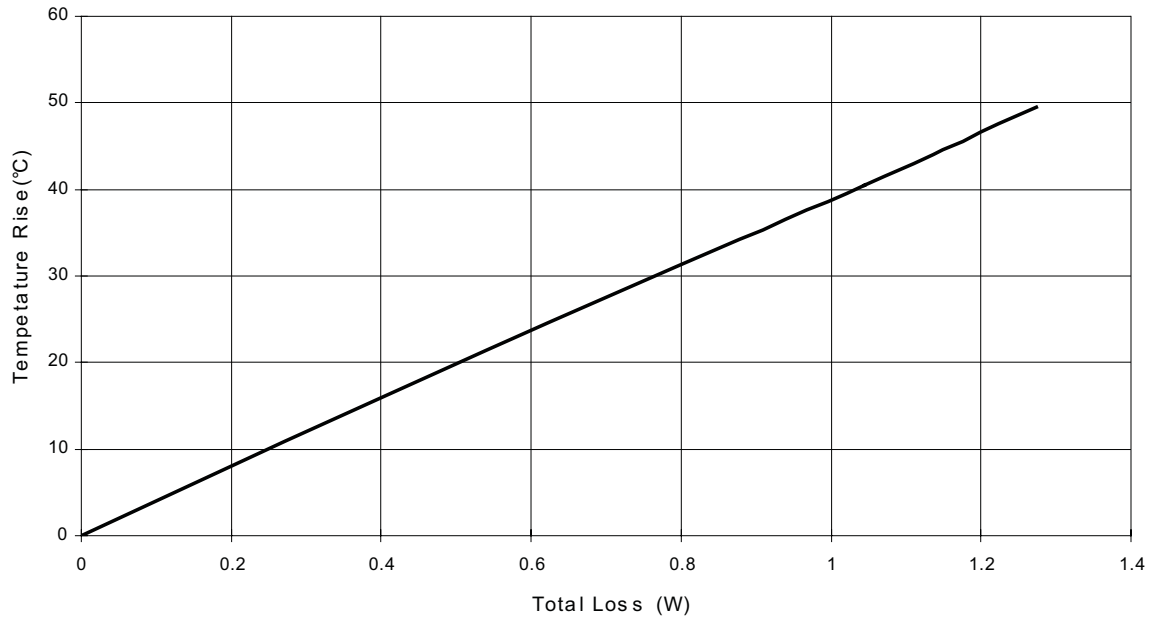

Core loss vs. B_{p-p}

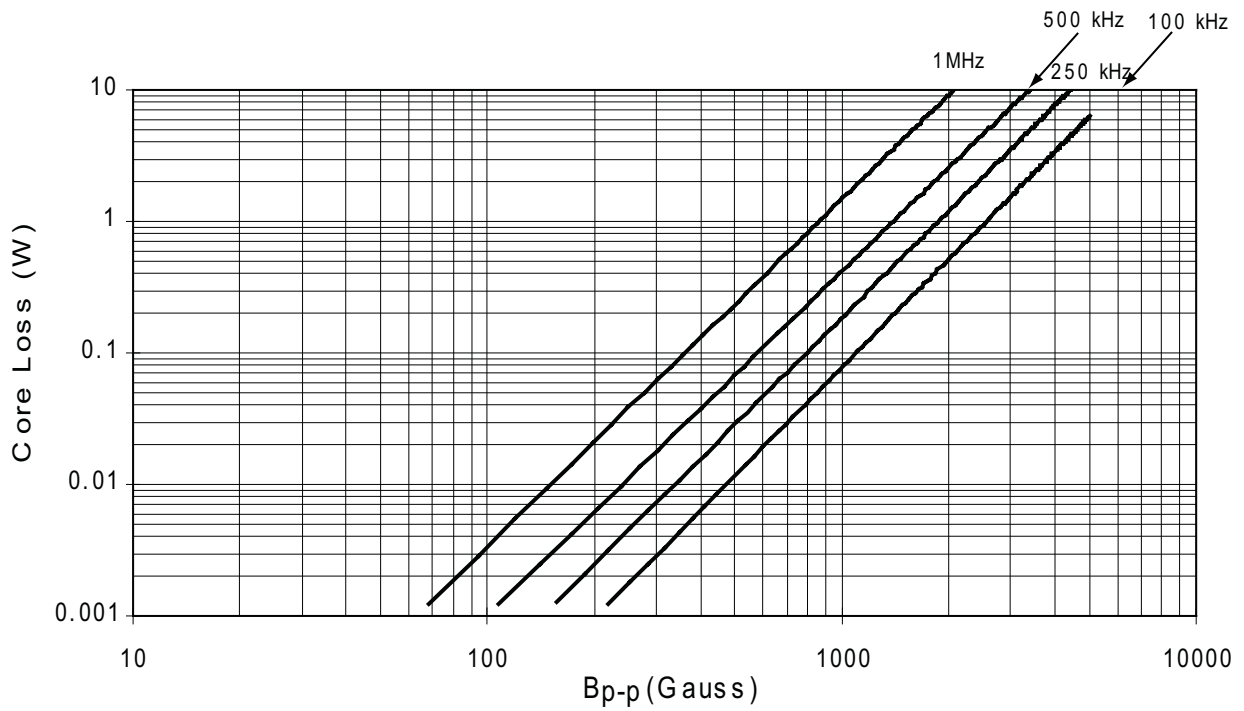

Inductance characteristics

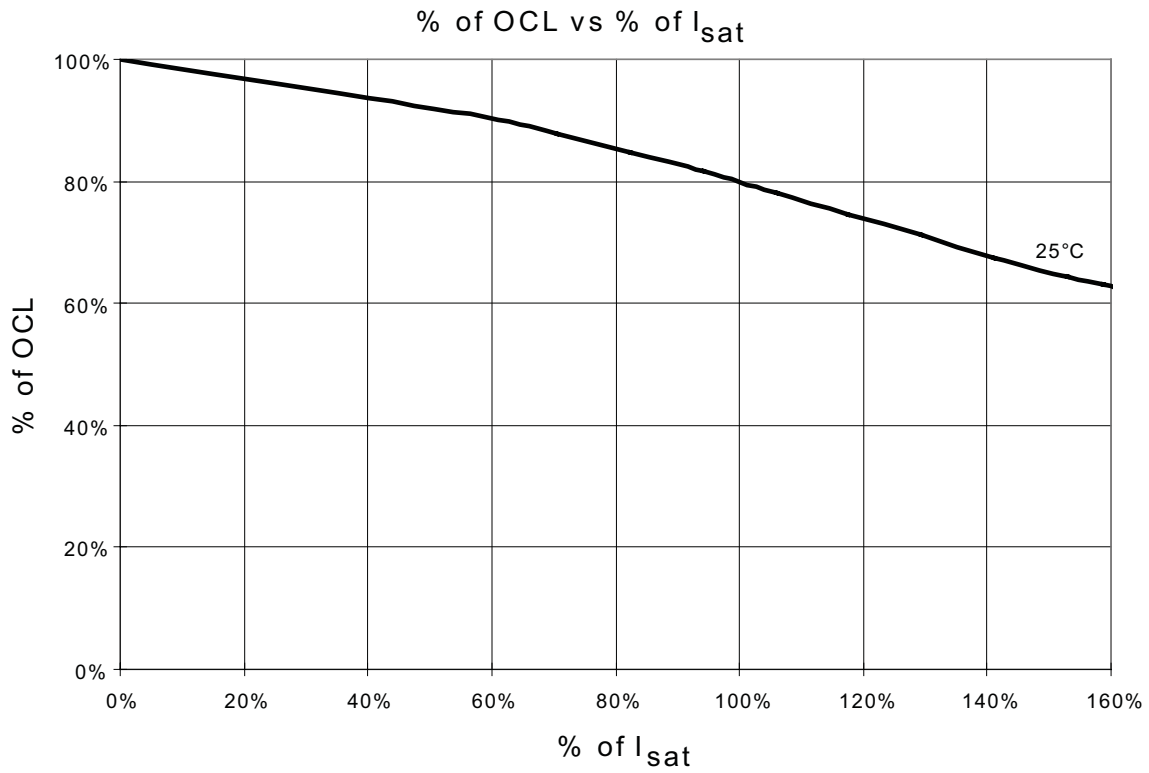

Solder reflow profile

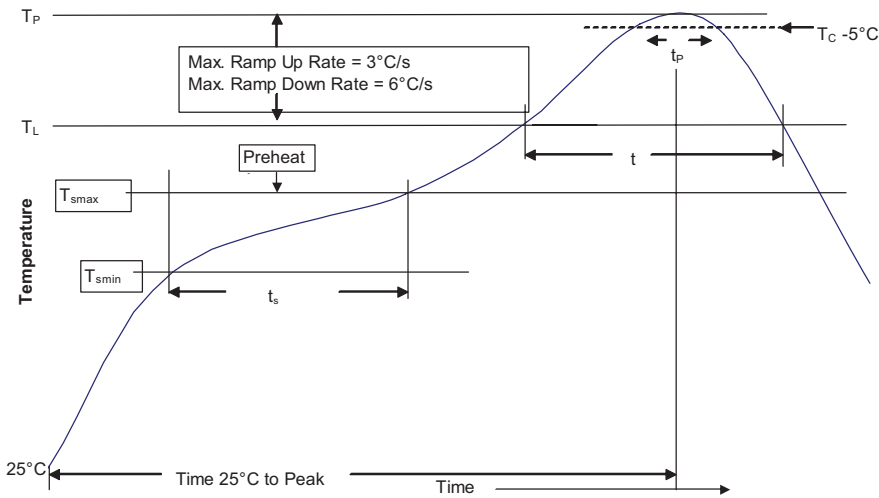

Table 1 - Standard SnPb Solder (T_c)

Package Thickness	Volume mm ³ <350	Volume mm ³ ≥350
<2.5mm)	235°C	220°C
≥2.5mm	220°C	220°C

Table 2 - Lead (Pb) Free Solder (T_c)

Package Thickness	Volume mm ³ <350	Volume mm ³ 350 - 2000	Volume mm ³ >2000
<1.6mm	260°C	260°C	260°C
1.6 - 2.5mm	260°C	250°C	245°C
>2.5mm	250°C	245°C	245°C

Reference JEDEC J-STD-020

Profile Feature	Standard SnPb Solder	Lead (Pb) Free Solder
Preheat and Soak		
• Temperature min. (T_{smin})	100°C	150°C
• Temperature max. (T_{smax})	150°C	200°C
• Time (T_{smin} to T_{smax}) (t_s)	60-120 Seconds	60-120 Seconds
Average ramp up rate T_{smax} to T_p	3°C/ Second Max.	3°C/ Second Max.
Liquidous temperature (T_L)	183°C	217°C
Time at liquidous (t_L)	60-150 Seconds	60-150 Seconds
Peak package body temperature (T_p)*	Table 1	Table 2
Time (t_p)** within 5 °C of the specified classification temperature (T_c)	20 Seconds**	30 Seconds**
Average ramp-down rate (T_p to T_{smax})	6°C/ Second Max.	6°C/ Second Max.
Time 25°C to Peak Temperature	6 Minutes Max.	8 Minutes Max.

* Tolerance for peak profile temperature (T_p) is defined as a supplier minimum and a user maximum.

** Tolerance for time at peak profile temperature (t_p) is defined as a supplier minimum and a user maximum.

Life Support Policy: Eaton does not authorize the use of any of its products for use in life support devices or systems without the express written approval of an officer of the Company. Life support systems are devices which support or sustain life, and whose failure to perform, when properly used in accordance with instructions for use provided in the labeling, can be reasonably expected to result in significant injury to the user.

Eaton reserves the right, without notice, to change design or construction of any products and to discontinue or limit distribution of any products. Eaton also reserves the right to change or update, without notice, any technical information contained in this bulletin.

Eaton
Electronics Division
1000 Eaton Boulevard
Cleveland, OH 44122
United States
www.eaton.com/electronics

© 2017 Eaton
All Rights Reserved
Printed in USA
Publication No. 4348 BU-SB09086
July 2017

Eaton is a registered trademark.

All other trademarks are property of their respective owners.

Mouser Electronics

Authorized Distributor

Click to View Pricing, Inventory, Delivery & Lifecycle Information:

[Eaton:](#)

[HCP0704-1R8-R](#) [HCP0704-1R0-R](#) [HCP0704-3R3-R](#) [HCP0704-R40-R](#) [HCP0704-4R7-R](#) [HCP0704-2R3-R](#)
[HCP0704-R60-R](#)