

**NOTES**

**MATERIAL:** -ABS UL94 VO WITH BRASS INSERTS & M3 SCREWS.  
 -STYRENE SELF TAPPING SCREWS.  
 -AVAILABLE IN BLACK & GRAY

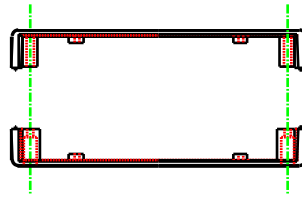
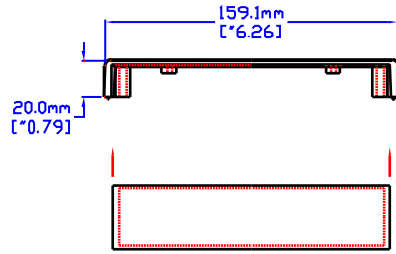

**CASE 'A' & 'B'**

**3D VIEW  
 (NOT TO SCALE)**

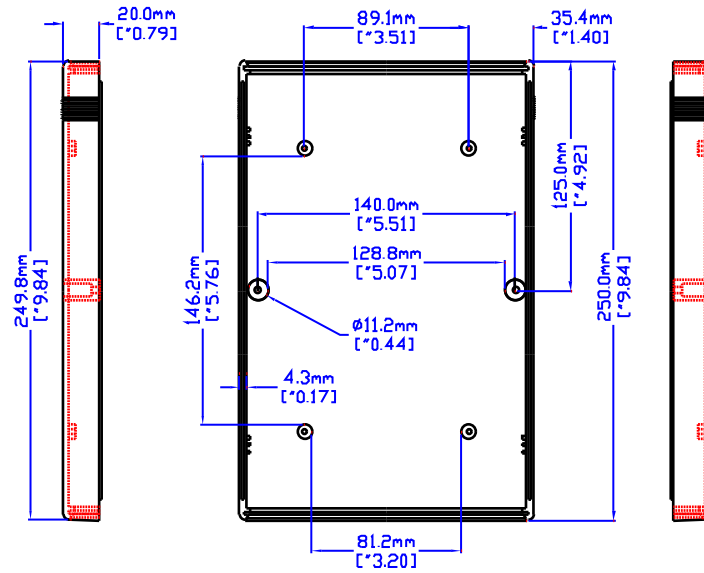
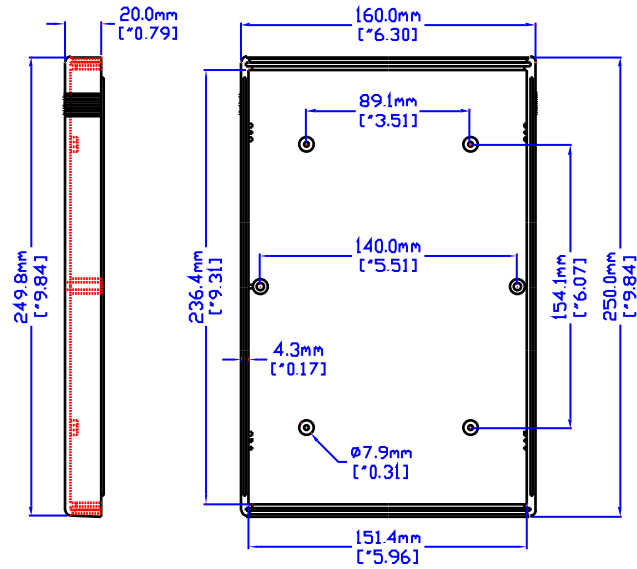
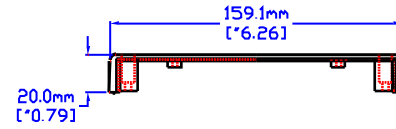
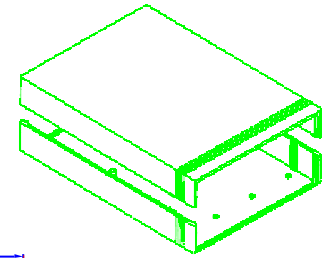

**CASE 'B'**

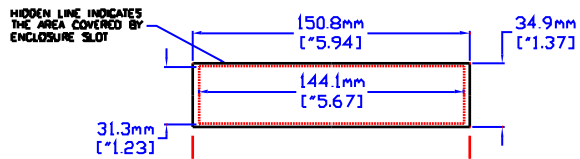

**CASE 'A'**

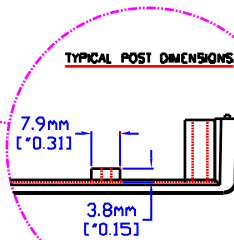

**HAMMOND MANUFACTURING**

**1598F**

CANADA - PH (519) 886 7170 - FAX (519) 886 8311  
 U.S.A. - PH (716) 631 5700 - FAX (716) 631 1156