

N-Channel Enhancement Mode Field Effect Transistor

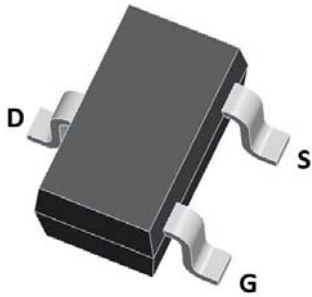

SOT-323

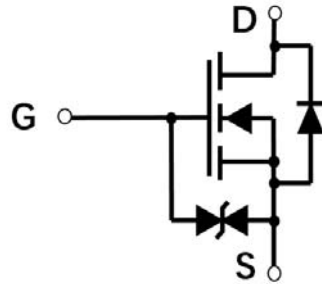
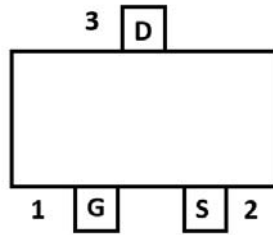

Product Summary

- V_{DS} 60V
- I_D 300mA
- $R_{DS(ON)}$ (at $V_{GS}=10V$) <2.5ohm
- $R_{DS(ON)}$ (at $V_{GS}=4.5V$) <3.0ohm
- ESD Protected Up to 2.0KV (HBM)

General Description

- Trench Power MV MOSFET technology
- Voltage controlled small signal switch
- Low input Capacitance
- Fast Switching Speed
- Low Input / Output Leakage
- Part no. with suffix "Q" means AEC-Q101 qualified

Applications

- Battery operated systems
- Solid-state relays
- Direct logic-level interface: TTL/CMOS

■ Absolute Maximum Ratings ($T_A=25^\circ\text{C}$ unless otherwise noted)

Parameter	Symbol	Limit	Unit
Drain-source Voltage	V_{DS}	60	V
Gate-source Voltage	V_{GS}	± 20	V
Drain Current	I_D	$T_A=25^\circ\text{C}$ @ Steady State	300
		$T_A=70^\circ\text{C}$ @ Steady State	240
Pulsed Drain Current ^A	I_{DM}	1.5	A
Total Power Dissipation @ $T_A=25^\circ\text{C}$	P_D	300	mW
Thermal Resistance Junction-to-Ambient @ Steady State ^B	$R_{\theta JA}$	416	$^\circ\text{C}/\text{W}$
Junction and Storage Temperature Range	T_J, T_{STG}	-55~+150	$^\circ\text{C}$

■ Ordering Information (Example)

PREFERRED P/N	PACKING CODE	Marking	MINIMUM PACKAGE(pcs)	INNER BOX QUANTITY(pcs)	OUTER CARTON QUANTITY(pcs)	DELIVERY MODE
2N7002KCWQ	F2	72KC.	3000	30000	120000	7" reel



2N7002KCWQ

■ Electrical Characteristics (T_J=25°C unless otherwise noted)

Parameter	Symbol	Conditions	Min	Typ	Max	Units
Static Parameter						
Drain-Source Breakdown Voltage	BV _{DSS}	V _{GS} = 0V, I _D =250μA	60			V
Zero Gate Voltage Drain Current	I _{DSS}	V _{DS} =60V, V _{GS} =0V			1	μA
Gate-Body Leakage Current	I _{GSS}	V _{GS} = ±20V, V _{DS} =0V			±10	μA
Gate Threshold Voltage	V _{GS(th)}	V _{DS} = V _{GS} , I _D =250μA	1	1.5	2.5	V
Static Drain-Source On-Resistance	R _{DS(ON)}	V _{GS} = 10V, I _D =300mA		1.9	2.5	Ω
		V _{GS} = 4.5V, I _D =200mA		2.0	3.0	
Diode Forward Voltage	V _{SD}	I _S =300mA, V _{GS} =0V			1.2	V
Maximum Body-Diode Continuous Current	I _S				300	mA
Dynamic Parameters						
Input Capacitance	C _{iss}	V _{DS} =30V, V _{GS} =0V, f=1MHZ		27		pF
Output Capacitance	C _{oss}			3		
Reverse Transfer Capacitance	C _{rss}			2		
Switching Parameters						
Total Gate Charge	Q _g	V _{GS} =10V, V _{DS} =30V, I _D =0.3A		1.65	2.4	nC
Turn-on Delay Time	t _{D(on)}	V _{GS} =10V, V _{DD} =30V, I _D =300mA, R _{GEN} =6Ω		6.5		ns
Turn-off Delay Time	t _{D(off)}			9.6		
Reverse recovery Time	t _{rr}	V _{GS} =0V, I _S =300mA, V _R =25V, di/dt=-100A/μs		24		ns

A. Pulse Test: Pulse Width ≤ 300us, Duty cycle ≤ 2%.

B. Device mounted on FR-4 PCB, 1 inch x 0.85 inch x 0.062 inch.



■ Typical Performance Characteristics

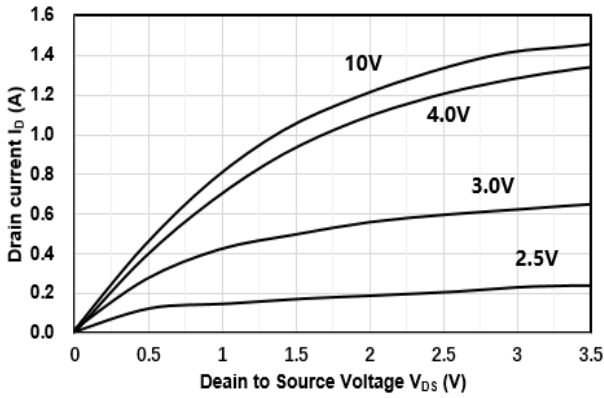

Figure1. Output Characteristics

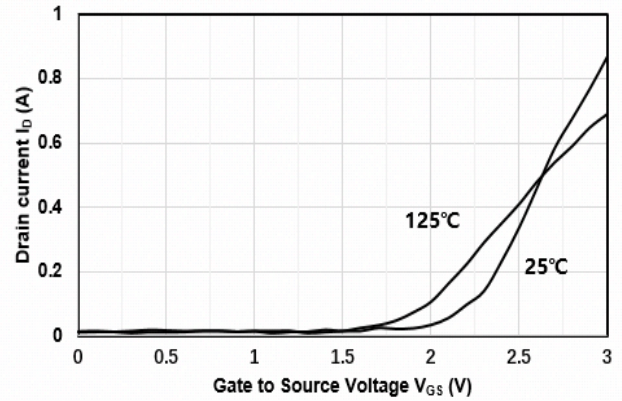

Figure2. Transfer Characteristics

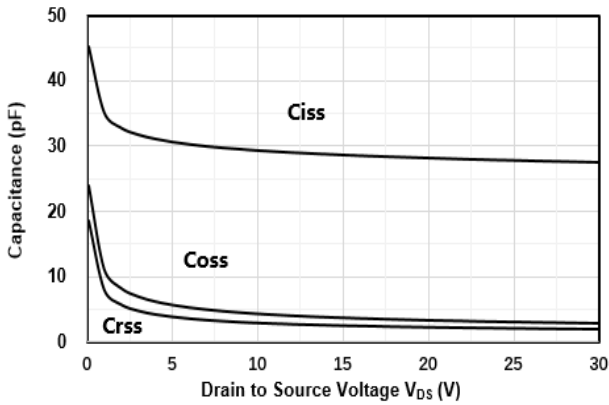

Figure3. Capacitance Characteristics

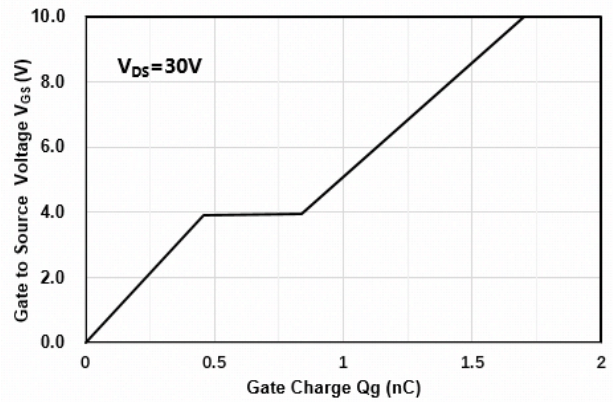

Figure4. Gate Charge

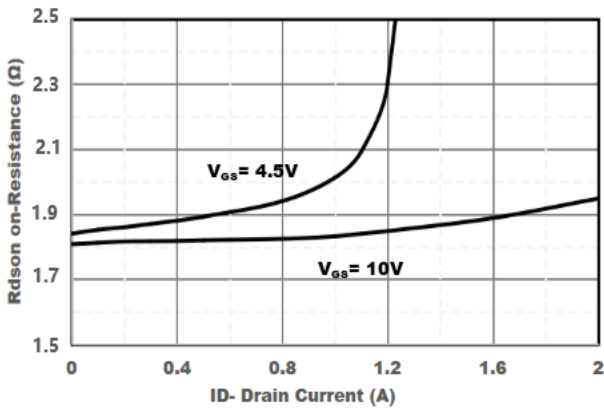

Figure5. Drain-Source on Resistance

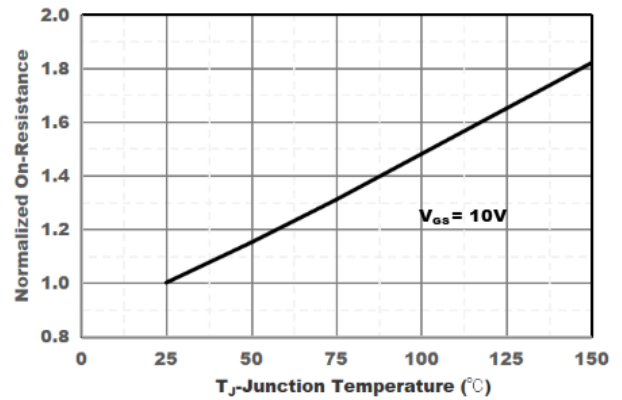

Figure6. Drain-Source on Resistance



2N7002KCWQ

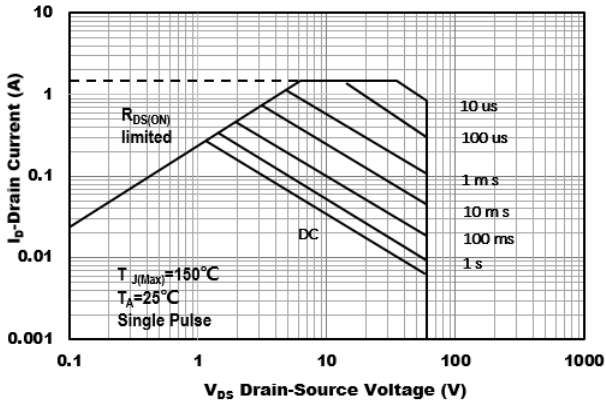

Figure7. Safe Operation Area

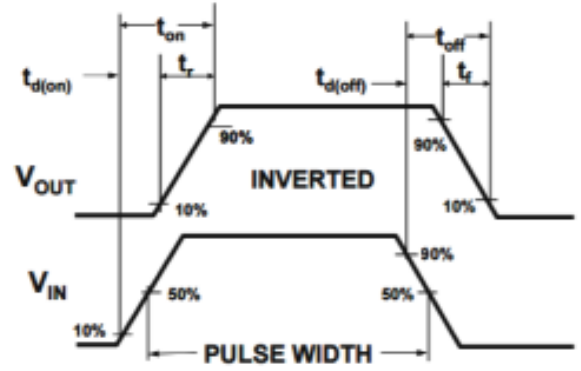
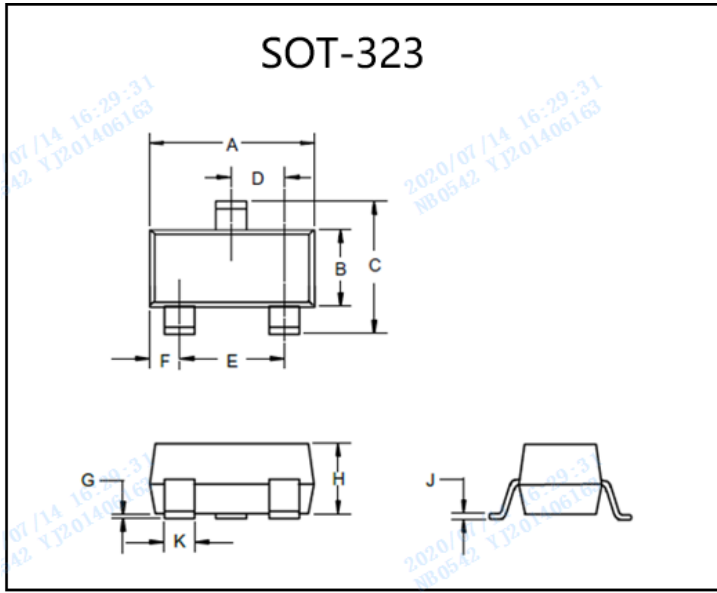

Figure8. Switching wave



2N7002KCWQ

■SOT-323 Package Outline Dimensions



DIM	INCHES		MM		NOTE
	MIN	MAX	MIN	MAX	
A	0.071	0.087	1.80	2.20	
B	0.045	0.053	1.15	1.35	
C	0.083	0.096	2.10	2.45	
D	0.026Nominal		0.65Nominal		
E	0.047	0.055	1.20	1.40	
F	0.012	0.016	0.30	0.40	
G	0.000	0.004	0.00	0.10	
H	0.035	0.039	0.90	1.00	
J	0.004	0.010	0.10	0.250	
K	0.006	0.016	0.15	0.40	

■SOT-323 Suggested Pad Layout

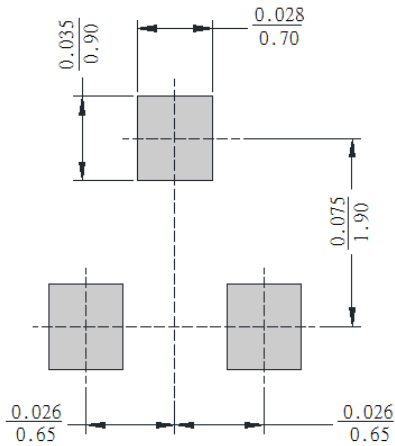



Disclaimer

The information presented in this document is for reference only. Yangzhou Yangjie Electronic Technology Co., Ltd. reserves the right to make changes without notice for the specification of the products displayed herein to improve reliability, function or design or otherwise.

The product listed herein is designed to be used with automotive electronics, are not designed for use in medical, life-saving, lifesustaining, or military, Yangjie or anyone on its behalf, assumes no responsibility or liability for any damages resulting from such improper use of sale.

This publication supersedes & replaces all information previously supplied. For additional information, please visit our website [http:// www.21yangjie.com](http://www.21yangjie.com) , or consult your nearest Yangjie's sales office for further assistance.



2N7002KCWQ

REV.	EFFECTIVE DATE	REVISION HISTORY	PREPARED
1.0	2021.06.11	New release	Zhenzhong Zhao