

N-Channel Enhancement Mode Power MOSFET

- Features**

$V_{DS} = 100V,$
 $I_D = 10.5A$
 $R_{DS(ON)} @ V_{GS} = 10V, \text{ TYP } 9.7m\Omega$
 $R_{DS(ON)} @ V_{GS} = 6V, \text{ TYP } 11 m\Omega$
 $R_{DS(ON)} @ V_{GS} = 4.5V, \text{ TYP } 13.5m\Omega$

- General Description**

- load switch
- Power Management
- DC-DC Converter

- Pin Configurations**

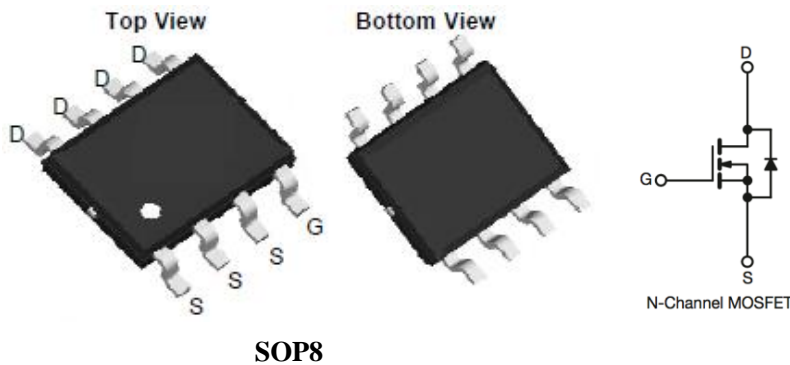

- Absolute Maximum Ratings @ $T_A=25^\circ\text{C}$ unless otherwise noted**

Parameter		Symbol	Ratings	Unit
Drain-Source Voltage		V_{DSS}	100	V
Gate-Source Voltage		V_{GSS}	± 20	V
Drain Current (Continuous) *AC	$T_A=25^\circ\text{C}$	I_D	10.5	A
	$T_A=70^\circ\text{C}$		8.4	
Drain Current (Pulse) *B		I_{DM}	45	A
Power Dissipation	$T_A=25^\circ\text{C}$	P_D	2.5	W
Operating Temperature/ Storage Temperature		T_J/T_{STG}	-55~150	$^\circ\text{C}$

- Thermal Resistance Ratings**

Parameter		Symbol	Maximum	Unit
Maximum Junction-to-Ambient	$t \leq 10s$	R_{thJA}	50	$^\circ\text{C/W}$

● **Electrical Characteristics @ $T_A=25^\circ\text{C}$ unless otherwise noted**

Parameter	Symbol	Test Conditions	Min	Typ	Max	Unit
Static						
Drain-Source Breakdown Voltage	$V_{(BR)DSS}$	$V_{GS} = 0V, I_D = 250\mu A$	100	--	--	V
Zero Gate Voltage Drain Current	I_{DSS}	$V_{DS} = 80V, V_{GS} = 0V$	--	--	1	μA
Gate Threshold Voltage	$V_{GS(TH)}$	$V_{GS} = V_{DS}, I_{DS} = 250\mu A$	1	2.2	3	V
Gate Leakage Current	I_{GSS}	$V_{GS} = \pm 20V, V_{DS} = 0V$	--	--	± 100	nA
Drain-Source On-state Resistance	$R_{DS(on)}$	$V_{GS} = 10V, I_D = 15A$	--	9.7	12.5	m Ω
	$R_{DS(on)}$	$V_{GS} = 6V, I_D = 12A$	--	11	14.5	m Ω
	$R_{DS(on)}$	$V_{GS} = 4.5V, I_D = 8A$	--	13.5	17.5	m Ω
Diode Forward Voltage	V_{SD}	$I_{SD} = 1A, V_{GS} = 0V$	--	0.73	1.2	V
Diode Forward Current *AC	I_S	$T_A = 25^\circ\text{C}$	--	--	3.4	A
Switching B						
Total Gate Charge	Q_g	$V_{GS} = 10V, V_{DS} = 50V,$ $I_{DS} = 20A$	--	33	--	nC
Gate-Source Charge	Q_{gs}		--	8.6	--	nC
Gate-Drain Charge	Q_{gd}		--	7.5	--	nC
Turn-on Delay Time	$t_{d(on)}$	$V_{GS} = 10V, V_{DS} = 50V,$ $R_L = 5\Omega, R_{GEN} = 1\Omega$	--	13	--	ns
Turn-on Rise Time	t_r		--	9	--	ns
Turn-off Delay Time	$t_{d(off)}$		--	38	--	ns
Turn-Off Fall Time	t_f		--	11	--	ns
Dynamic						
Input Capacitance	C_{iss}	$V_{DS} = 50V, V_{GS} = 0V, f = 1.0\text{MHz}$	--	1681	--	pF
Output Capacitance	C_{oss}		--	832	--	pF
Reverse Transfer Capacitance	C_{rss}		--	11	--	pF

A: The value of $R_{\theta JA}$ is measured with the device mounted on 1in² FR-4 board with 2oz. Copper, in a still air environment with $T_A=25^\circ\text{C}$. The value in any given application depends on the user's specific board design.

B: Repetitive rating, pulse width limited by junction temperature.

C: The current rating is based on the $t \leq 10s$ junction to ambient thermal resistance rating.

● **Typical Performance Characteristics (T_J = 25 °C, unless otherwise noted)**

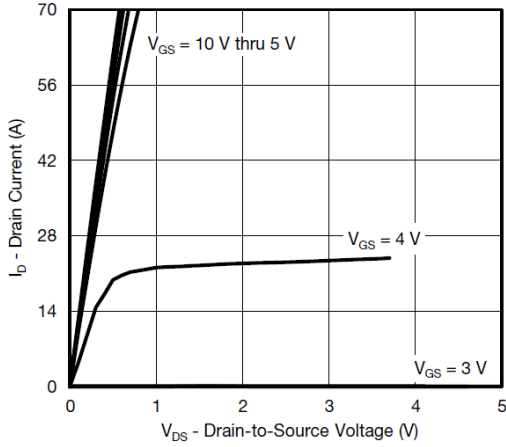

Output Characteristics

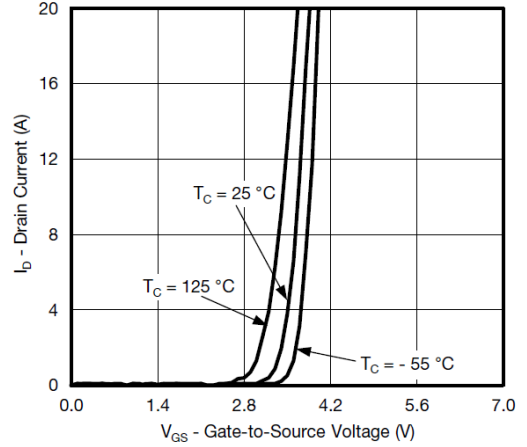

Transfer Characteristics

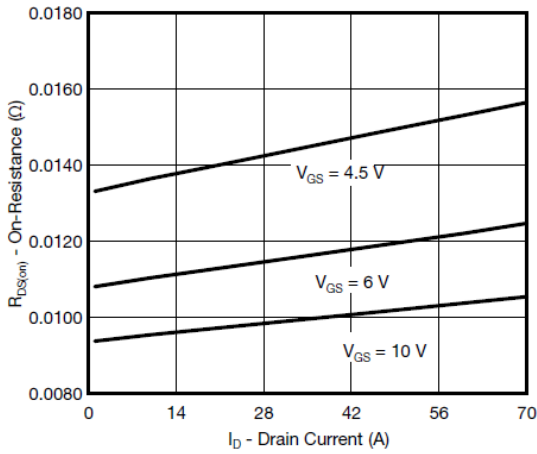

On-Resistance vs. Drain Current

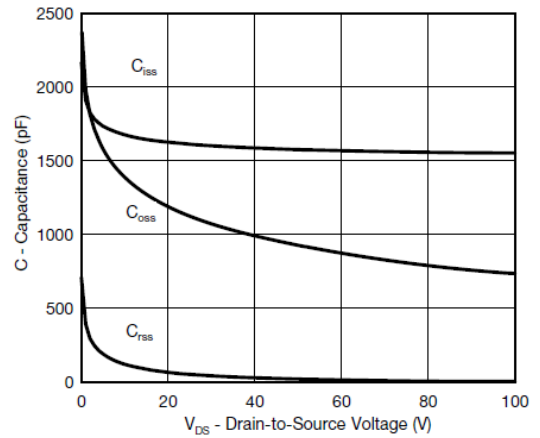

Capacitance

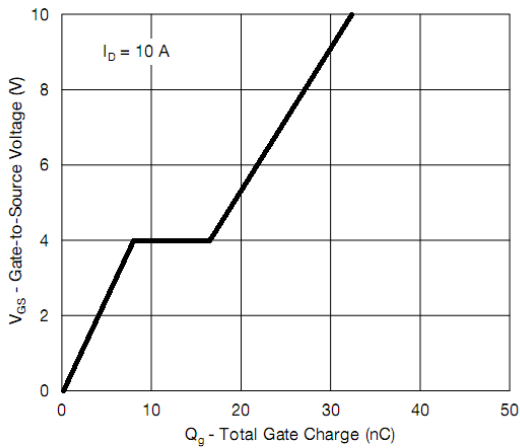

Gate Charge

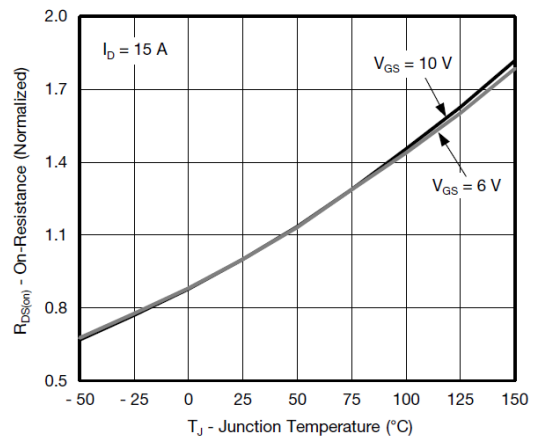

On-Resistance vs. Junction Temperature

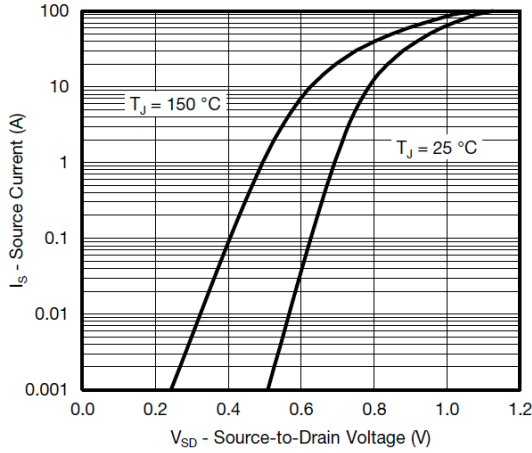

Source-Drain Diode Forward Voltage

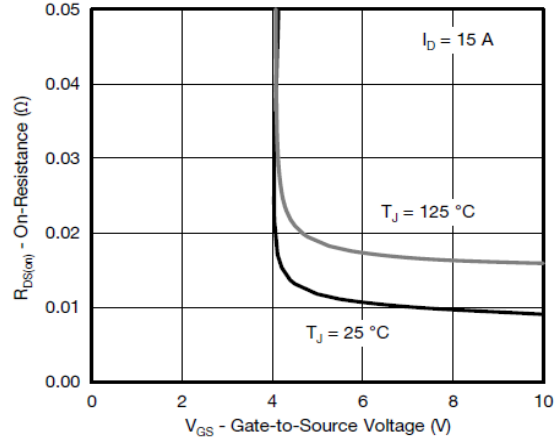

On-Resistance vs. Gate-to-Source Voltage

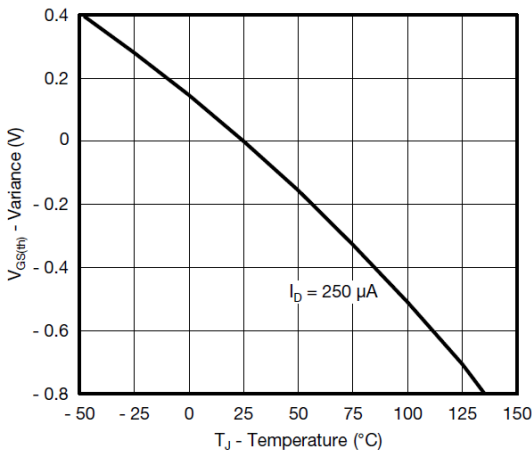

Threshold Voltage

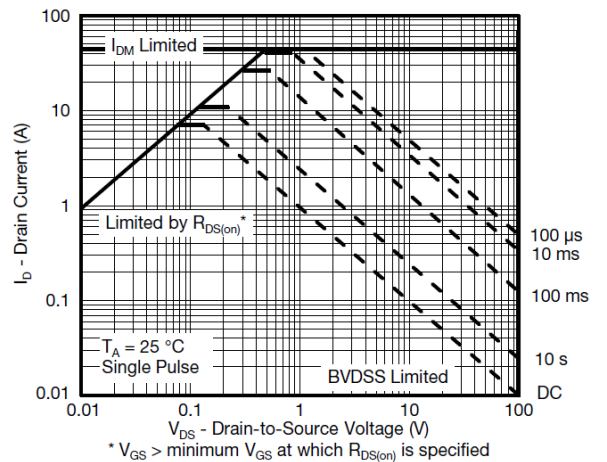

Safe Operating Area, Junction-to-Ambient

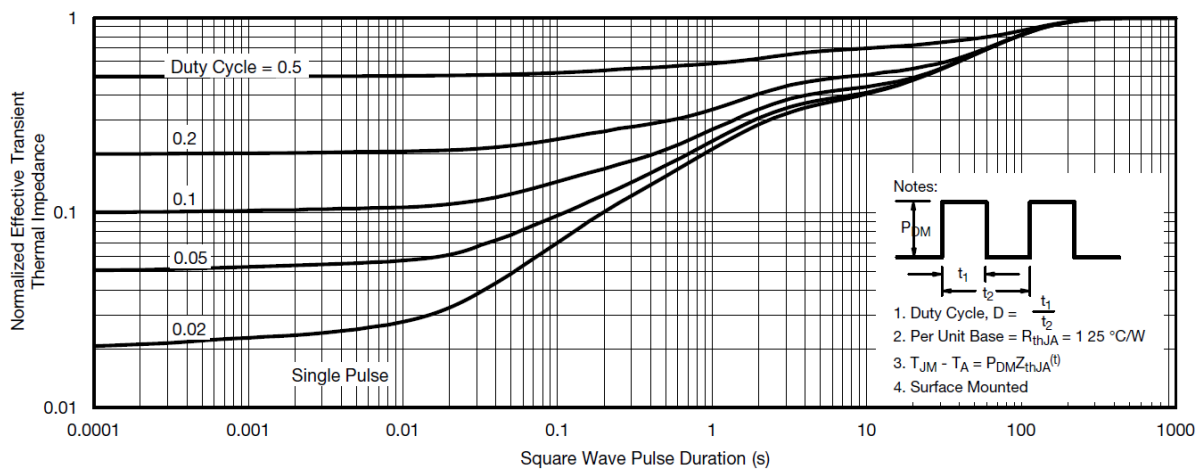

Normalized Thermal Transient Impedance, Junction-to-Ambient

● Package Information

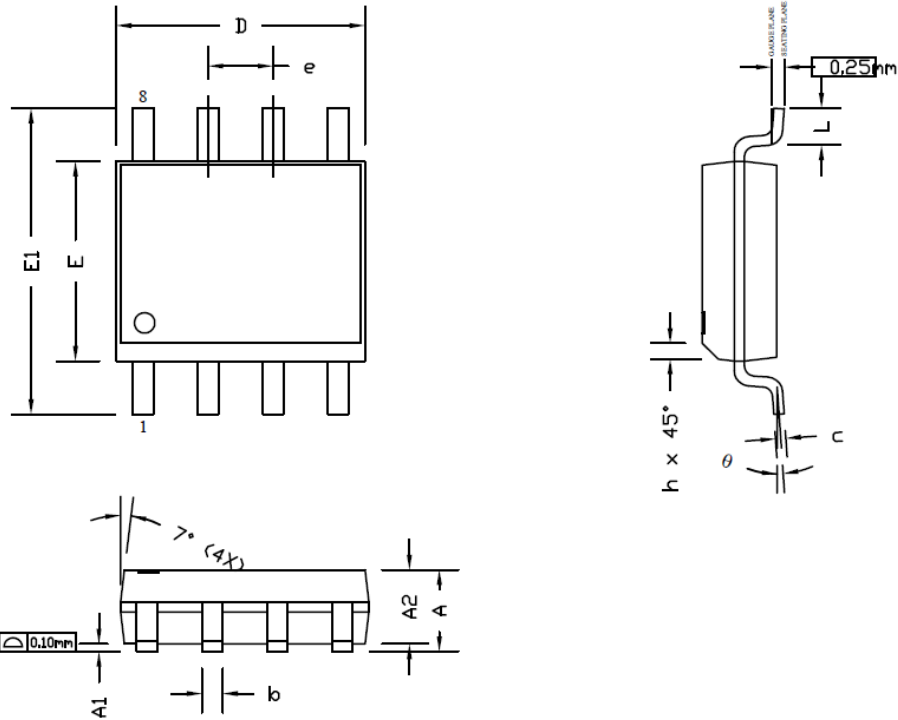

RECOMMENDED LAND PATTERN

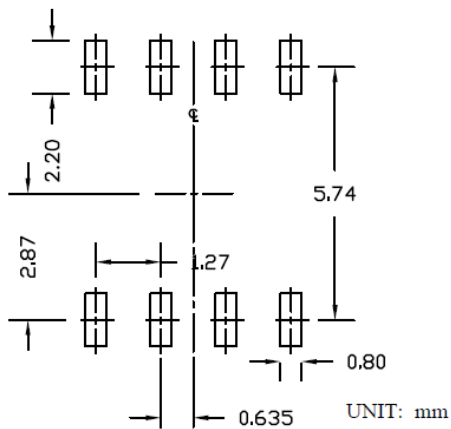

SYMBOLS	DIMENSIONS IN MILLIMETERS			DIMENSIONS IN INCHES		
	MIN	NOM	MAX	MIN	NOM	MAX
A	1.35	1.65	1.75	0.053	0.065	0.069
A1	0.10	0.15	0.25	0.004	0.006	0.010
A2	1.25	1.50	1.65	0.049	0.059	0.065
b	0.31	0.41	0.51	0.012	0.016	0.020
c	0.17	0.20	0.25	0.007	0.008	0.010
D	4.80	4.90	5.00	0.189	0.193	0.197
E	3.80	3.90	4.00	0.150	0.154	0.157
e	1.27 BSC			0.050 BSC		
E1	5.80	6.00	6.20	0.228	0.236	0.244
h	0.25	0.30	0.50	0.010	0.012	0.020
L	0.40	0.69	1.27	0.016	0.027	0.050
θ	0°	4°	8°	0°	4°	8°

NOTE

1. ALL DIMENSIONS ARE IN MILLIMETERS.
2. DIMENSIONS ARE INCLUSIVE OF PLATING.
3. PACKAGE BODY SIZES EXCLUDE MOLD FLASH AND GATE BURRS.
MOLD FLASH AT THE NON-LEAD SIDES SHOULD BE LESS THAN 6 MILS EACH.
4. DIMENSION L IS MEASURED IN GAUGE PLANE.
5. CONTROLLING DIMENSION IS MILLIMETER.
CONVERTED INCH DIMENSIONS ARE NOT NECESSARILY EXACT.