

# TRANSFORMERS FOR DIGITAL AUDIO DATA TRANSMISSION



For Use with Cirrus Logic's CS8401, CS8402, CS8403 & CS8404 ICs



- Operating transmission rates: 1 to 7 Mbps
- Controlled rise time: 25 nsec MAX
- High isolation voltage: 2 kV MIN

## Electrical Specifications @ 25°C — Operating Temperature 0°C to 70°C

RoHS-6 Compliant Part No.	Turns Ratio (±5%)	Primary Inductance (mH ±20%)	L <sub>L</sub> (μH) MAX	Rise Time (nsec) MAX	ET (V-μsec) MIN	Isolation (V <sub>rms</sub> ) MIN	Bandwidth (100 KHz-55 MHz) TYP	Return Loss (100 kHz-10 MHz) MIN	Schematic
PE-65612NL	1:1	2.5	.50	25	20	2000	3 dB	20 dB	THT

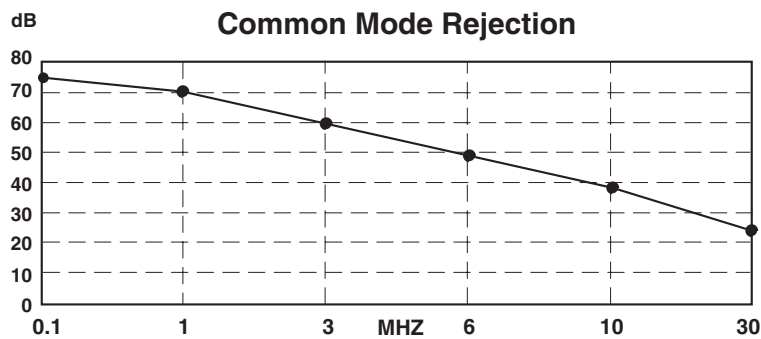

## Mechanical

## Schematic

PE-65612NL

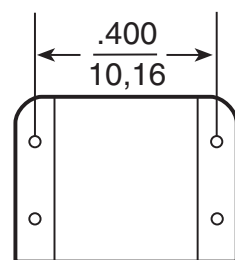
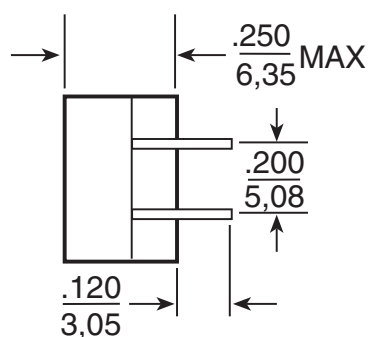
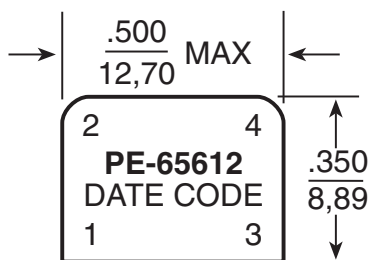

Leads are 24 AWG-solderable

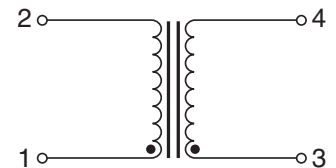

PE-65612NL  
 Weight.....1.2 grams  
 Tape & Reel.....NA  
 Tube.....60/tube

Dimensions:  $\frac{\text{Inches}}{\text{mm}}$   
 Unless otherwise specified all tolerances are  $\pm \frac{.010}{0,25}$

# TRANSFORMERS FOR DIGITAL AUDIO DATA TRANSMISSION

For Use with Cirrus Logic's CS8401, CS8402, CS8403 & CS8404 ICs

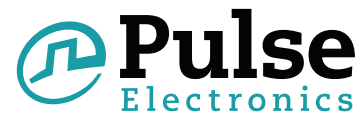

## Application

This transformer has been designed for use at the interface between line driver and receiver and the interconnecting medium in Digital Audio Data Transmission Systems according to AES 3-199X or IEC 958. In such systems, two channels of periodically sampled and uniformly quantized audio signals are transmitted on a single shielded twisted pair.

The electrical parameters of the interface are based on those of CCITT V.11 or balanced voltage digital circuits which allow signal transmission up to a few hundred meters. The isolation transformers are essential in improving the balance of the transmitter and the receiver circuitry, and reducing common mode noise and EMI.

This transformer is recommended for use with the Cirrus Logic CS8401, CS8402, CS8403 and CS8404 "Digital Audio Interface Transmit Device."

The schematic below represents an implementation of transmit and receive circuits using isolation transformers at both ends. Equalization in the receiver may permit to increase the length of the interconnecting cable.

## Applicable Documents

AES 3-1985 (ANSI S4.40-1985), AES 3-199XDraft, IEC 958, CP-340, EBU 3250

## Application Circuit

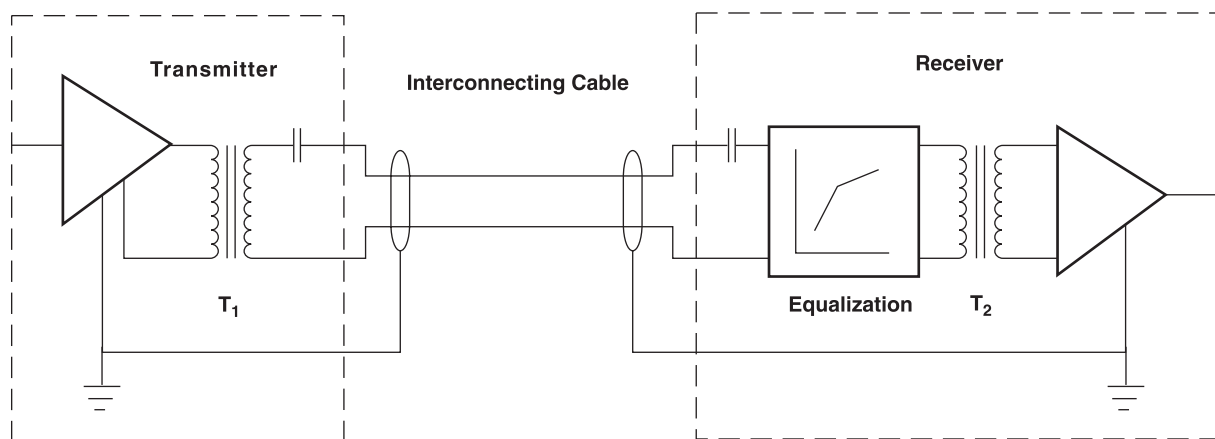

T<sub>1</sub>, T<sub>2</sub>: PE-65612NL

## For More Information

**Pulse Worldwide Headquarters**  
12220 World Trade Drive  
San Diego, CA 92128  
U.S.A.

**Pulse Europe**  
Zeppelinstrasse 15  
71083 Herrenberg  
Germany

**Pulse China Headquarters**  
B402, Shenzhen Academy of  
Aerospace Technology Bldg.  
10th Kejinan Road  
High-Tech Zone  
Nanshan District  
Shenzhen, PR China 518057  
Tel: 86 755 33966678  
Fax: 86 755 33966700

**Pulse North China**  
Room 2704/2705  
Super Ocean Finance Ctr.  
2067 Yan An Road West  
Shanghai 200336  
China

Tel: 86 21 62787060  
Fax: 86 21 62786973

**Pulse South Asia**  
135 Joo Seng Road  
#03-02  
PM Industrial Bldg.  
Singapore 368363

Tel: 65 6287 8998  
Fax: 65 6287 8998

**Pulse North Asia**  
3F No. 198, Zhongyuan Road  
Zhongli City  
Taoyuan County (32068)  
Taiwan

Tel: 886 3 4356768  
Fax: 886 3 4356823

Performance warranty of products offered on this data sheet is limited to the parameters specified. Data is subject to change without notice. Other brand and product names mentioned herein may be trademarks or registered trademarks of their respective owners. © Copyright, 2013. Pulse Electronics, Inc. All rights reserved.

# Mouser Electronics

Authorized Distributor

Click to View Pricing, Inventory, Delivery & Lifecycle Information:

Pulse:

[PE-65612NL](#)