

DIO7527

5.5V Current Limited Load Switch

Features

- Input voltage range: 2.7V to 5.5V
- 2A Maximum Load Current
- 70m Ω typical $R_{DS(ON)}$
- 70 μ A quiescent current
- Under-Voltage Lockout
- High precision over current trigger point
- Open-drain Fault Flag Pin
- Output Reverse-Voltage Protection
- 6kV output pin ESD
- Available in Packages of SOT23-6, MSOP-8, EP-MSOP-8

Descriptions

The DIO7527 is a current limited P-channel MOSFET power switch, which designed for high side load switch applications.

An open-drain flag output is also available to indicate fault condition, including over current, thermal shut down, input UVLO and output reverse-voltage condition.

The load-switch product family from DIOO including almost all industry standard. Please contact our sales if you are interested.

Application

- Hot Swap Supplies
- Notebook Computers
- Peripheral Ports
- Personal Communication Devices

Block Diagram

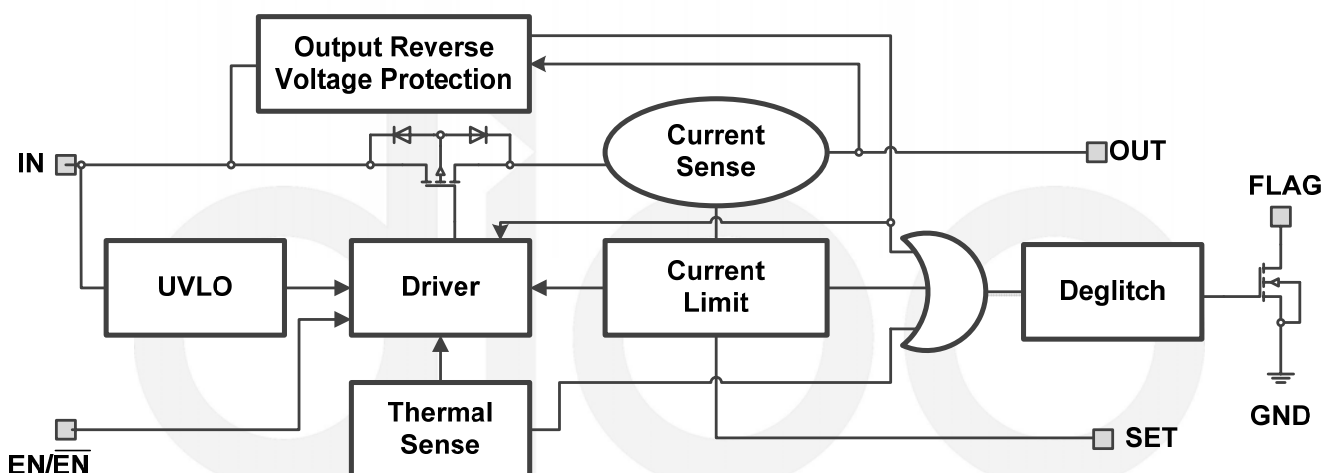

Figure 1 Functional Block Diagram

Ordering Information

Order Part Number	Top Marking	Enable	Output Shut down Resistor	T _A	Package	
DIO7527AST6	YW7A	Active High	Yes	-40 to +85°C	SOT23-6	Tape & Reel, 3000
DIO7527BST6	YW7B	Active Low	Yes	-40 to +85°C	SOT23-6	Tape & Reel, 3000
DIO7527CST6	YW7C	Active High	No	-40 to +85°C	SOT23-6	Tape & Reel, 3000
DIO7527DST6	YW7D	Active Low	No	-40 to +85°C	SOT23-6	Tape & Reel, 3000
DIO7527AMP8	D27A	Active High	Yes	-40 to +85°C	MSOP-8	Tape & Reel, 3000
DIO7527BMP8	D27B	Active Low	Yes	-40 to +85°C	MSOP-8	Tape & Reel, 3000
DIO7527CMP8	D27C	Active High	No	-40 to +85°C	MSOP-8	Tape & Reel, 3000
DIO7527DMP8	D27D	Active Low	No	-40 to +85°C	MSOP-8	Tape & Reel, 3000
DIO7527AXM8	D27A	Active High	Yes	-40 to +85°C	EP-MSOP-8	Tape & Reel, 3000
DIO7527BXM8	D27B	Active Low	Yes	-40 to +85°C	EP-MSOP-8	Tape & Reel, 3000
DIO7527CXM8	D27C	Active High	No	-40 to +85°C	EP-MSOP-8	Tape & Reel, 3000
DIO7527DXM8	D27D	Active Low	No	-40 to +85°C	EP-MSOP-8	Tape & Reel, 3000

Pin Assignment

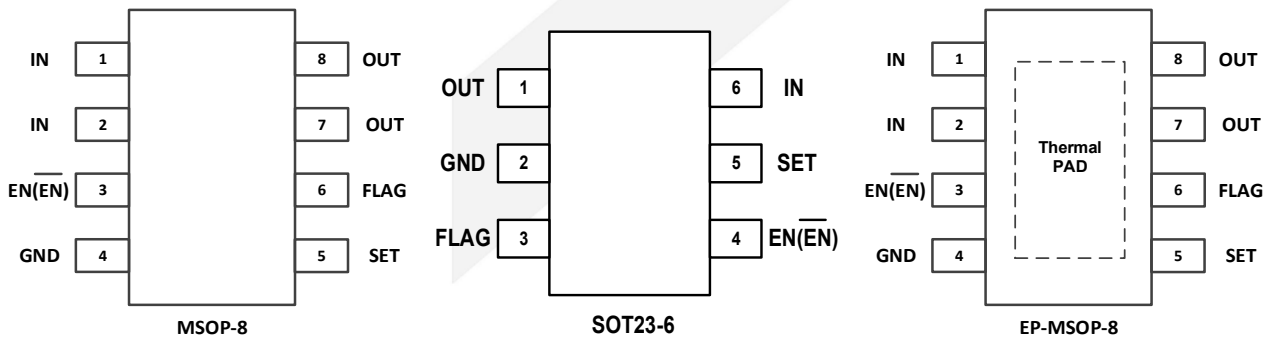

Figure 1 Pin Assignment

Pin Description

Name	Function
OUT	Output pin, decoupled with a capacitor to GND
GND	Ground pin
SET	Current limit programming pin. Connect a resistor R _{SET} from this pin to ground to program the current limit.
EN($\overline{\text{EN}}$)	ON/OFF control. Pull high to enable IC. Do not leave it floating
FLAG	Open-drain Fault Flag Pin.
IN	Input pin, decoupled with a capacitor to GND.

Absolute Maximum Ratings

Stresses beyond those listed under "Absolute Maximum Rating" may cause permanent damage to the device. These are stress ratings only and functional operation of the device at these or any other condition beyond those indicated in the operational sections of the specifications is not implied. Exposure to absolute maximum rating conditions for extended periods may affect device reliability.

Parameter		Rating	Unit
Terminal Voltage(With respect to GND)	V _{IN}	-0.3 to 6.0	V
	Other Inputs	-0.3 to 6.0	
Fault Flag Voltage	V _{FLG}	-0.3 to 6.0	V
Fault Flag Current	I _{FLG}	50	mA
Package Thermal Resistance	SOT23-6	190	°C/W
	EP-MSOP-8	100	°C/W
Maximum Junction Temperature		150	°C
Operating Temperature/T _A		-40 to 85	°C
Storage Temperature/T _{STO}		-65 to 150	°C
Lead Temperature Rating		300	°C
ESD Susceptibility	HBM (Human Body Mode)	6	KV
	CDM (Charged Device Mode)	2	

Recommended Operating Conditions

The Recommended Operating Conditions table defines the conditions for actual device operation. Recommended Operating conditions are specified to ensure optimal performance to the datasheet specifications. DIOO does not Recommend exceeding them or designing to Absolute Maximum Ratings.

Parameter	Rating	Unit
IN	2.7-5.5	V
All other pins	0-5.5	V
Junction Temperature Range	-40 to 125	°C
Ambient Temperature Range	-40 to 85	°C

Electrical Characteristics

Typical value: $T_A = 25^{\circ}\text{C}$, $V_{IN}=5\text{V}$, unless otherwise specified.

Symbol	Parameters	Conditions	Min	Typ.	Max	Unit
V_{IN}	Operation Voltage		2.7		5.5	V
$R_{DS(ON)}$	On Resistance	$V_{IN}=5\text{V}$		70		m Ω
I_{OS}	Over Current Limit	$R_{SET}=39\text{k}\Omega$	0.9	1	1.1	A
I_Q	Quiescent Supply Current	Open load, IC Enabled.		70		μA
T_r	Turn On Time	$R_L=10\Omega$, 90% Setting		0.4		ms
$V_{EN(H)}$	EN Input Threshold-High V_{IH}		1.4			V
$V_{EN(L)}$	EN Input Threshold-Low V_{IL}				0.4	V
	FLAG Deglitch Time	FLAG assertion or desertion	4	8	15	ms
	Output Reverse Voltage Deglitch Time		2.5	4	7	ms
I_{SHDN}	Shut down Input Current	Open load, IC Disabled.			1	μA
	Shut down Pull low Resistance			330		Ω
T_{SD}	Thermal Shut down			140		$^{\circ}\text{C}$
	Thermal Limit Hysteresis			20		$^{\circ}\text{C}$

Specifications subject to change without notice.



Typical Performance Characteristic

Typical value: $T_A = 25^\circ\text{C}$, $C_{IN}=C_{OUT}=10\mu\text{F}$, $R_{set}=19.5\text{k}\Omega$, unless otherwise specified.

Supply Current vs. Input Voltage

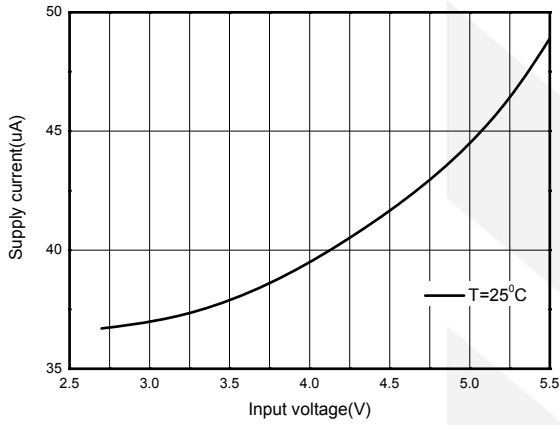

Operation Current vs. Ambient temperature

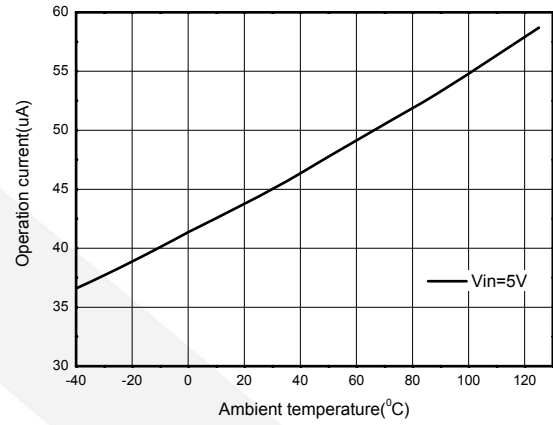

Enable Voltage vs. Input Voltage

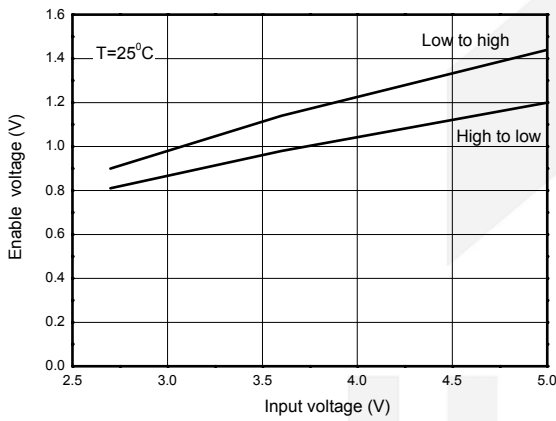

On Resistance vs. Input Voltage

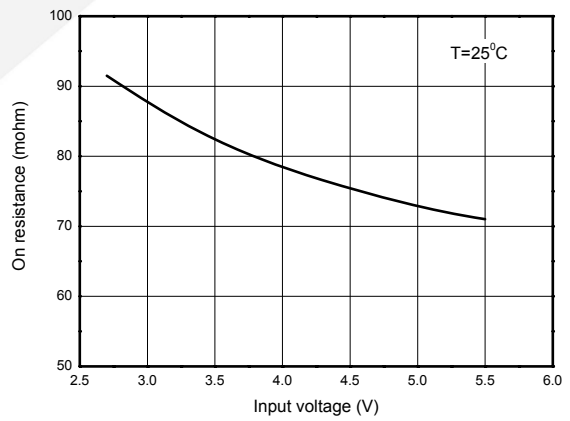

On Resistance vs. Ambient Temperature

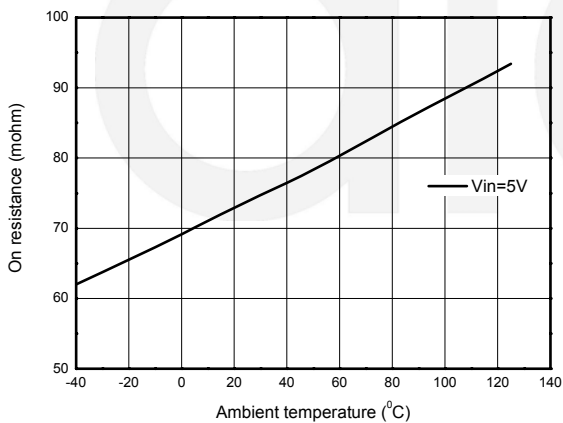

VIN Startup

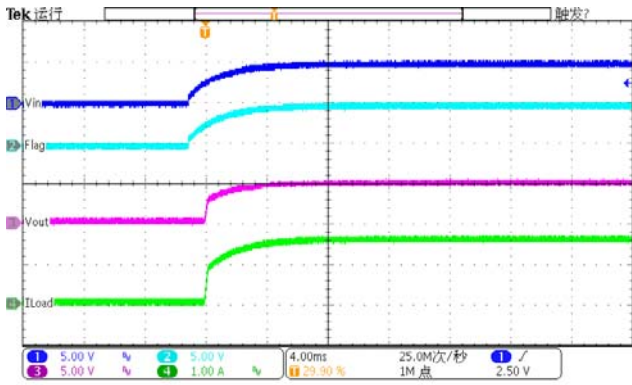

VIN Shutdown

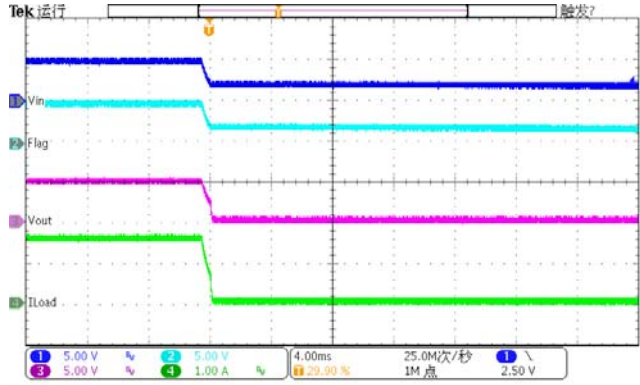

EN Startup

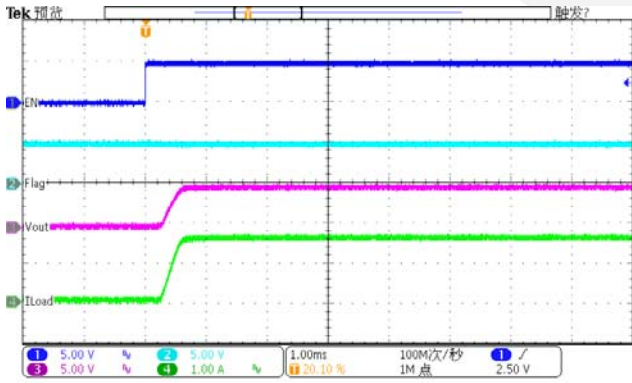

EN Shutdown

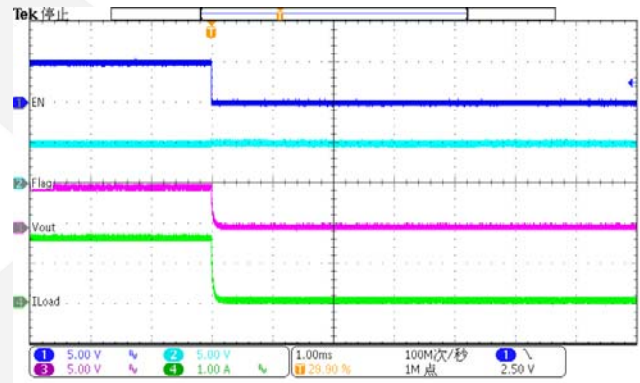

Short Circuit Protection (no load)

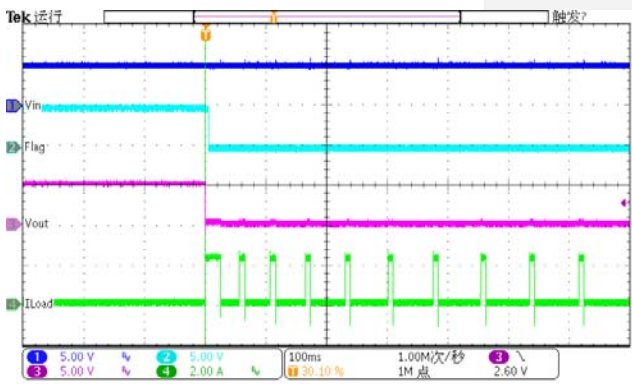

Short Circuit Recovery (no load)

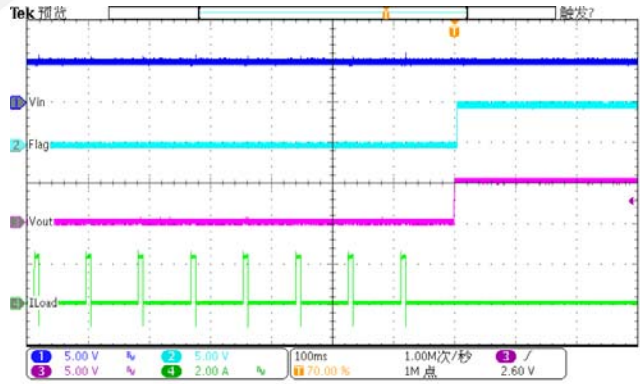

Short Circuit Protection (Rload=3Ω)

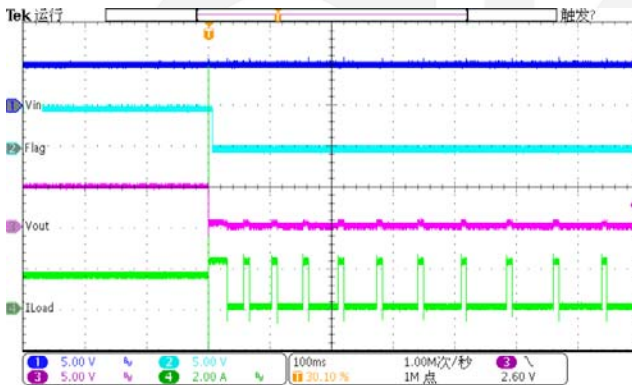

Short Circuit Recovery (Rload=3Ω)

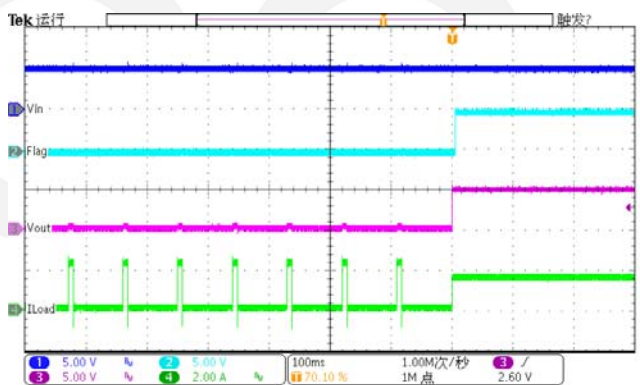

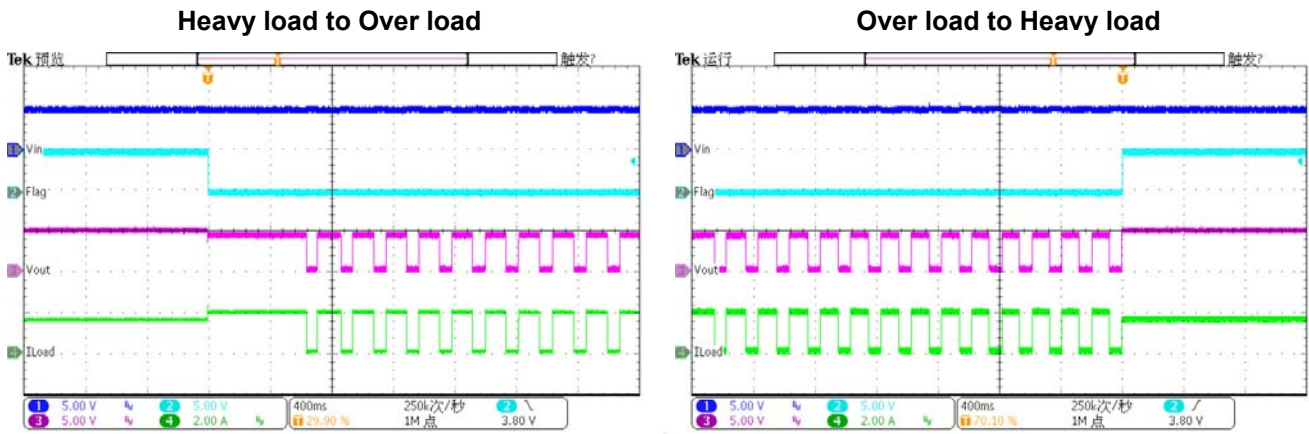

Applicaion Information

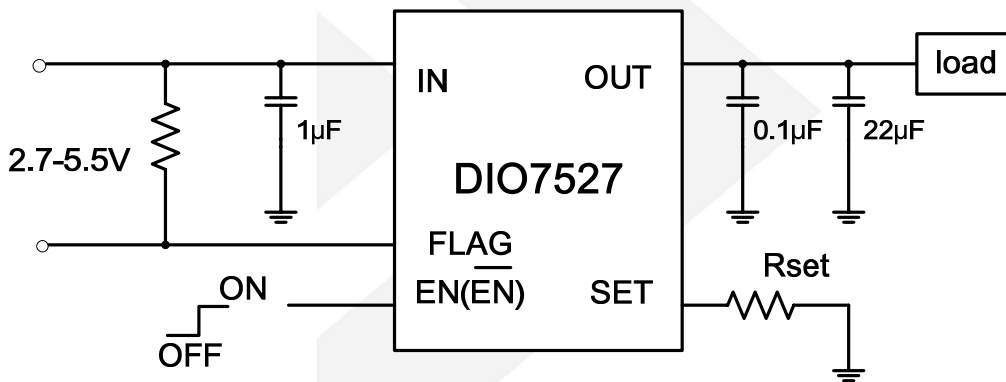

Figure 2 Typical Characteristics Reference Schematic

Operation Information

DIO7527 is a current limited P-channel MOSFET power switch with over current, thermal shut down, input UVLO and output reverse-voltage condition.

Under Voltage Lockout

A voltage sense circuit monitors the input voltage. When the input voltage is below approximately 2.4V, a control signal turns off the power switch.

Over-current Protection

When the over-current condition is detected, the switch is regulated to achieve constant output current. If the over current condition lasts for a long time, and results in a junction temperature over 140°C, the switch will be shut down. Once the junction temperature drops to 120°C, the part will restart.

Supply Filter Capacitor

In order to prevent the input voltage from dropping during hot-plug condition, a 10µF ceramic capacitor from V_{IN} to GND is strongly recommended. However, higher capacitance could help reduce the voltage drop. Further more an output short will cause ringing on the input without the input capacitor. It could destroy the internal circuitry when the input transient voltage exceeds the absolute maximum supply voltage even for a short duration.

Current Limiting Setting

Current limit is programmable to protect the power source from over current and short circuit conditions. Connect

a resistor R_{SET} from I_{SET} pin to GND to program the current limit:

$$I_{OS}(A) = 39K/R_{set} (\Omega).$$

The minimum current limit is 0.4A. Current limit beyond 2A is not recommended.

Thermal Protection

Thermal protection prevents damage to the IC when heavy overload or short circuit conditions are present for extended periods of time. The conditions force the DIO7527 into constant current mode, and under short circuit conditions, the voltage across the switch is equal to the input voltage. The increased dissipation causes the junction temperature to rise to high levels. The protection circuit senses the junction temperature of the switch and shuts it off. Hysteresis is built into the thermal sense circuit, and after the device has cooled approximately 20 degrees, the switch turns back on. The switch continues to cycle in this way until the overload or input power is removed.

FLG Output

An error Flag is an open-drained output of an N-channel MOSFET. Flag output is pulled low when the below conditions happen: input under voltage lockout, output current limit, output short circuit and over temperature shut down. The flag response delay time is 5ms typically.



Physical Dimensions: SOT-23-6

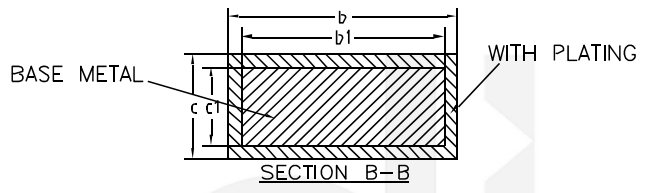
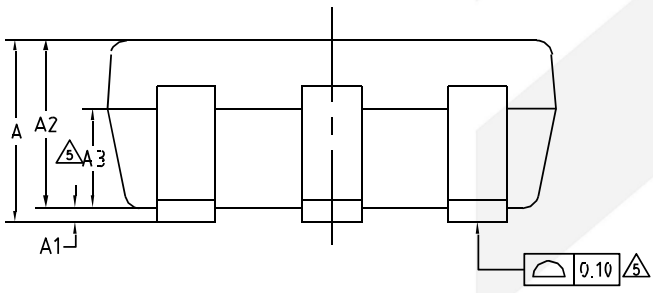
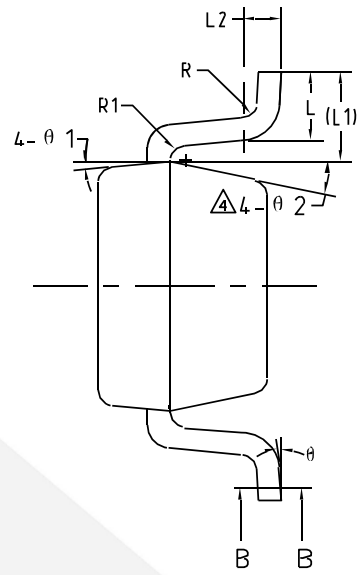
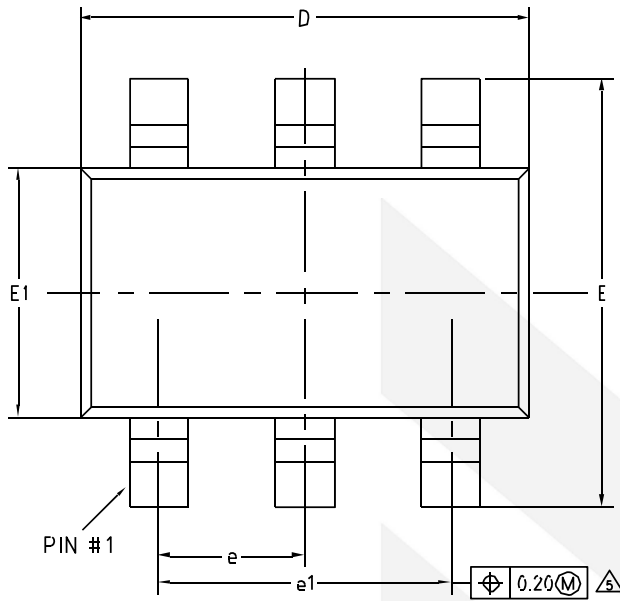

COMMON DIMENSIONS (UNITS OF MEASURE=MILLIMETER)			
Symbol	MIN	NOM	MAX
A	-	-	1.25
A1	0	-	0.15
A2	1.00	1.10	1.20
A3	0.60	0.65	0.70
b	0.36	-	0.50
b1	0.36	0.38	0.45
c	0.14	-	0.20
c1	0.14	0.15	0.16
D	2.826	2.926	3.026
E	2.60	2.80	3.00
E1	1.526	1.626	1.726
e	0.90	0.95	1.00
e1	1.80	1.90	2.00
L	0.35	0.45	0.60
L1	0.59REF		
L2	0.25BSC		
R	0.10	-	-
R1	0.10	-	0.20
theta	0°	-	8°
theta 1	3°	5°	7°
theta 2	6°	-	14°

Physical Dimensions: MSOP-8

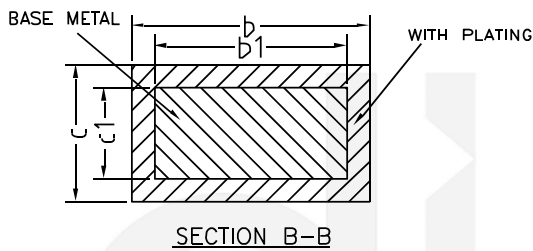
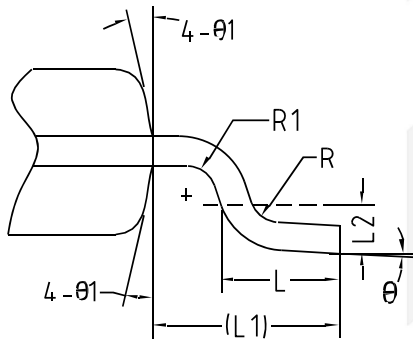
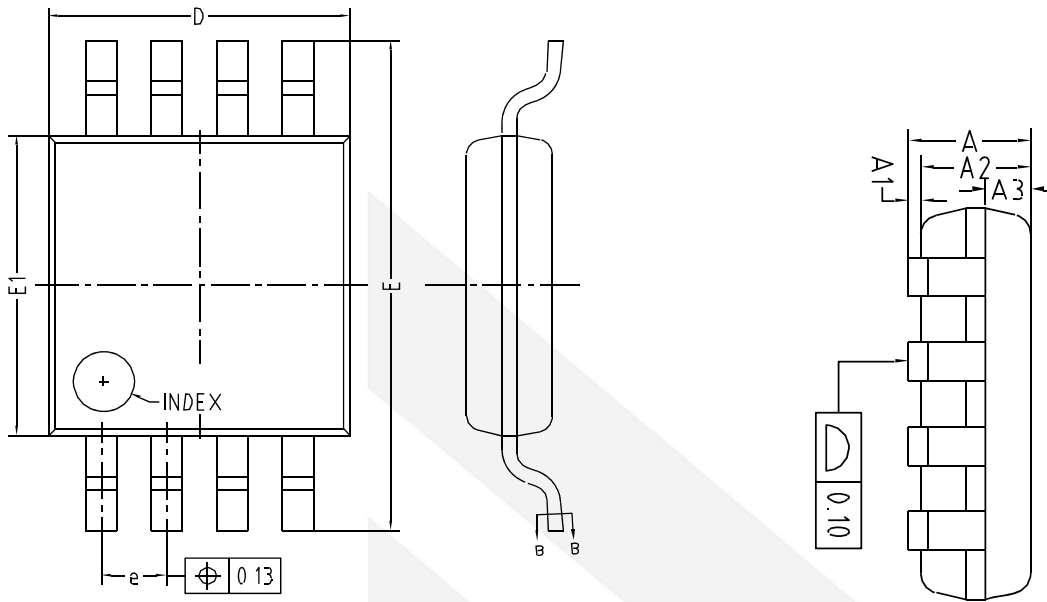

COMMON DIMENSIONS (UNITS OF MEASURE=MILLIMETER)			
Symbol	MIN	NOM	MAX
A	-	-	1.10
A1	0	-	0.15
A2	0.75	0.85	0.95
A3	0.25	0.35	0.39
b	0.28	-	0.37
b1	0.27	0.30	0.33
c	0.15	-	0.20
c1	0.14	0.15	0.16
D	2.90	3.00	3.10
E	4.70	4.90	5.10
E1	2.90	3.00	3.10
e	0.55	0.65	0.75
L	0.40	0.60	0.80
L1	0.95REF		
L2	0.25BSC		
R	0.07	-	-
R1	0.07	-	-
θ	0°	-	8°
θ1	9°	12°	15°

Physical Dimensions: EP-MSOP-8

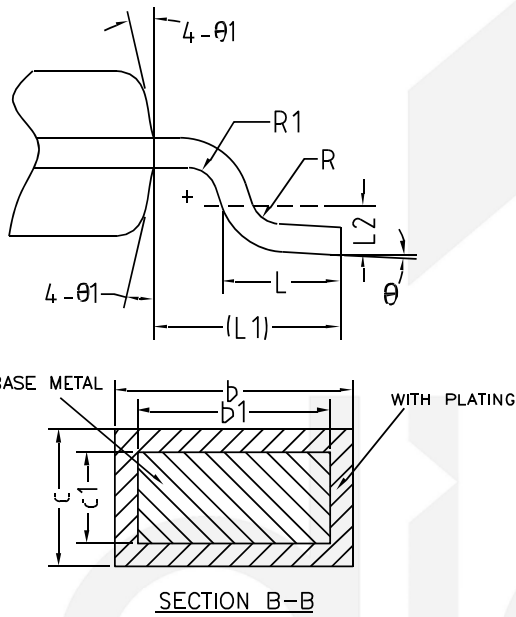
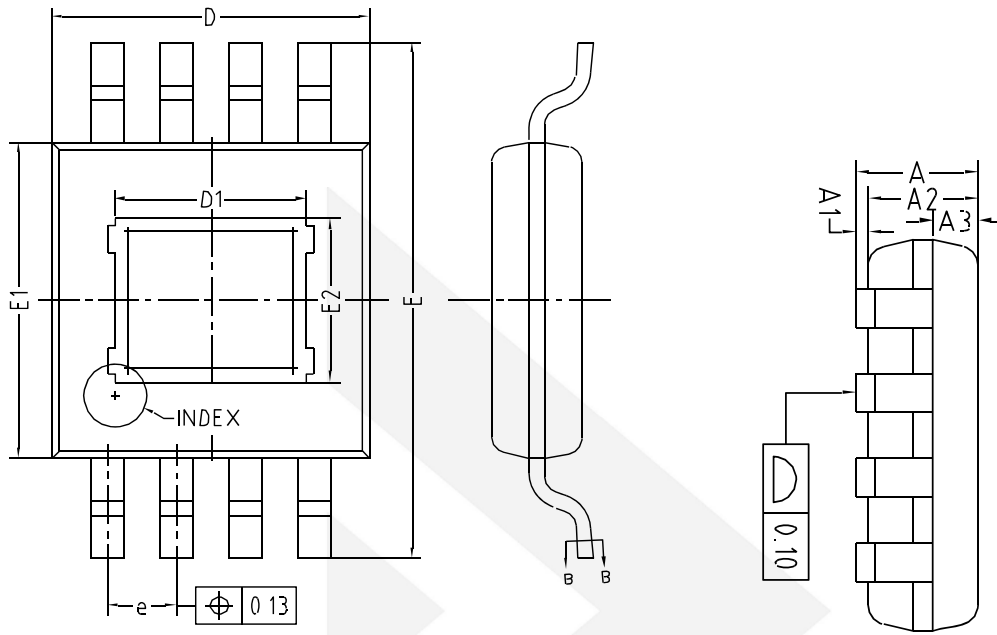

COMMON DIMENSIONS (UNITS OF MEASURE=MILLIMETER)			
Symbol	MIN	NOM	MAX
A	-	-	1.10
A1	0	-	0.15
A2	0.75	0.85	0.95
A3	0.25	0.35	0.39
b	0.28	-	0.37
b1	0.27	0.30	0.33
c	0.15	-	0.20
c1	0.14	0.15	0.16
D	2.90	3.00	3.10
D1	0.75	-	2.50
E	4.70	4.90	5.10
E1	2.90	3.00	3.10
E2	0.75	-	2.50
e	0.55	0.65	0.75
L	0.40	0.60	0.80
L1	0.95REF		
L2	0.25BSC		
R	0.07	-	-
R1	0.07	-	-
θ	0°	-	8°
θ1	9°	12°	15°

CONTACT US

Dioo is a professional design and sales corporation for high-quality and performance analog semiconductors. The company focuses on industry markets, such as, cell phone, handheld products, laptop, and medical equipment and so on. Dioo's product families include analog signal processing and amplifying, LED drivers and charger IC. Go to <http://www.dioo.com> for a complete list of Dioo product families.

For additional product information, or full datasheet, please contact with our Sales Department or Representatives.



Mouser Electronics

Authorized Distributor

Click to View Pricing, Inventory, Delivery & Lifecycle Information:

DIOO:

[DIO7527XST6](#) [DIO7527AST6](#) [DIO7527CST6](#) [DIO7527BST6](#) [DIO7527DST6](#)