

GSM-34-900-58-30CM-1814

860-960MHz PANEL 6dBi+RG58(30CM)+TNC FEMALE RP

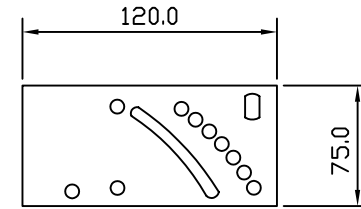
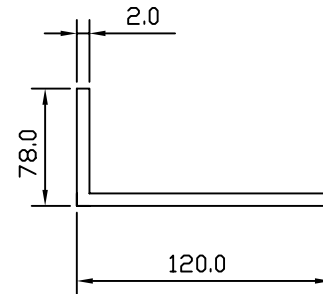
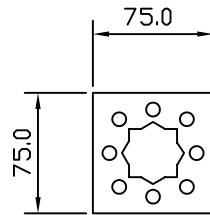
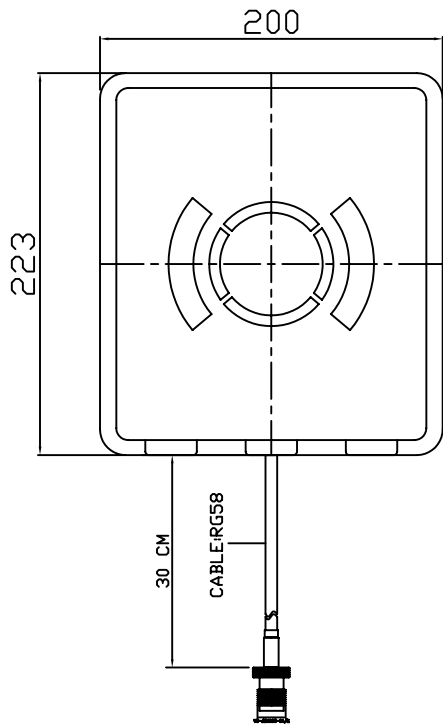
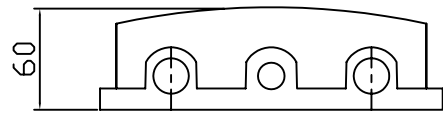

⊙ X4
WASHER

⊕ X4
NUT

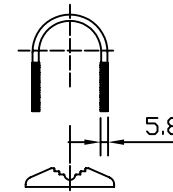
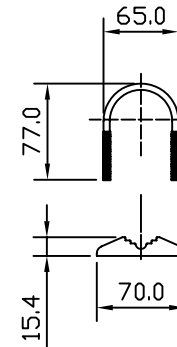

ANTENNA CONNECTOR : TNC FEMALE RP

1	FREQUENCY RANGE : 860-960 MHz	8	Dimensions : L223XW200XH60mm
2	GAIN : 6 dBi	9	
3	VSWR : < 1.6 : 1	10	
4	IMPEDANCE : 50 Ω	11	
5	POLARIZATION : LINEAR VERTICAL	12	
6	Antenna Connector : TNC FEMALE RP	13	
7	Maximum Power : 100W		

Mouser Electronics

Authorized Distributor

Click to View Pricing, Inventory, Delivery & Lifecycle Information:

[SparkFun Electronics:](#)

[WRL-14131](#)