

The miniature ECX-2236 is a compact SMD Crystal. The industry standard 2.5 x 2.0 x 0.55 mm is ideal for bluetooth, LoRa WAN, and wireless applications.

ECX-2236 SMD CRYSTAL

Request a Sample

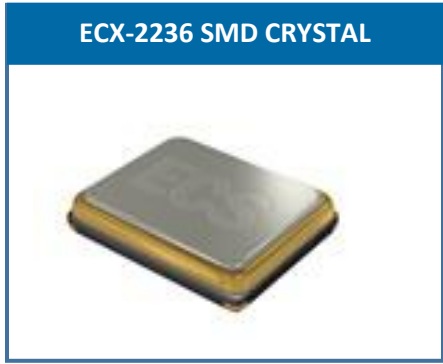

- Low Profile
- 2.5 x 2.0 mm Footprint
- Extended Temp. Range
- IOT/Wearable applications

OPERATING CONDITIONS / ELECTRICAL CHARACTERISTICS

PARAMETERS	CONDITIONS	ECX-2236			UNITS
		MIN	TYP	MAX	
Frequency		12.000		80.000	MHz
Mode of Oscillation	Fundamental				
Frequency Tolerance*	@ +25°C			± 50	ppm
Frequency Stability*	-20 ~ +70°C			± 50	ppm
Shunt Capacitance	Co			5	pF
Load Capacitance	Specify in P/N		8		pF
Drive Level	DL			100	μW
Operating Temperature*	Topr	-20		+70	°C
Storage Temperature	Tstg	-55		+125	°C
Aging (First Year)	@ +25°C ±3°C			±5	ppm

DIMENSIONS (mm)

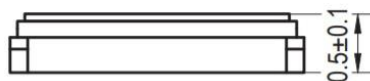
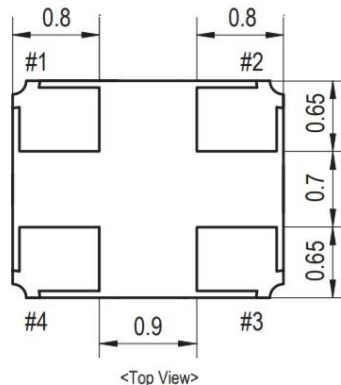
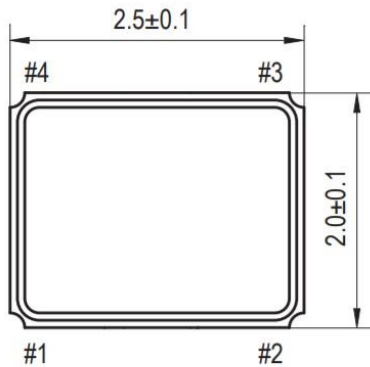
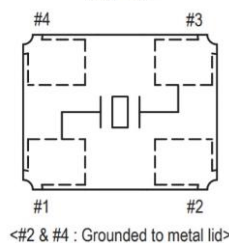

Figure 1) Top, Side, and Bottom

Crystal is symmetrical, pad 1 & 3 are interchangeable. Chamfer on the bottom pad has no electrical significance.



Pad Connections	
1	In/Out
2	Gnd
3	Out/In
4	Gnd

Frequency (MHz)	ESR Ω Max.
12.000 ~ 15.999	150
16.000 ~ 19.999	80
20.000 ~ 29.999	60
30.000 ~ 34.999	50
35.000 ~ 80.000	40

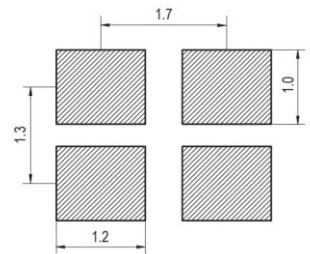

Figure 2) Suggested land

PART NUMBERING GUIDE: Example ECS-240-8-36-TR

ECS - FREQUENCY ABBREVIATION	LOAD CAPACITANCE	PACKAGE	AVAILABLE OPTIONS			PACKAGING	
			Tolerance	Stability	Temp Range		
ECS	240 = 24.000 MHz See P/N Guide	8 = 8 pF 10=10 pF	-36 = ECX-2236	Blank = Std A = ± 25 ppm J = ± 20 ppm R = ± 15 ppm C = ± 10 ppm	Blank= Std D = ± 100 ppm E = ± 50 ppm G = ± 30 ppm H = ± 25 ppm T = ± 20 ppm † W = ± 15 ppm † K = ± 10 ppm †	Blank= Std L = -10 ~ +70°C M = -20 ~ +70°C Y = -30 ~ +85°C N = -40 ~ +85°C P = -40 ~ +105°C S = -40 ~ +125°C U = -55 ~ +125°C	TR = Tape & Reel 1K/Reel

* Specify available options in P/N.

† Contact ECS for availability over extended temp range.

POCKET TAPE DIMENSIONS (mm)

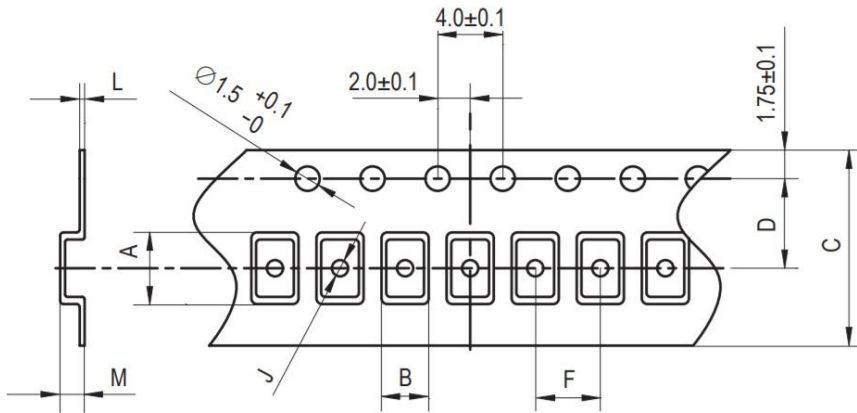

A	B	C	D	F	J	L	M	Reel Dia.	Qty/Reel
2.8	2.3	8.0	3.5	4.0	1.05	0.25	0.75	180	1000

SOLDER PROFILE	
Peak solder Temp +260°C Max 10 sec Max.	
2 Cycles Max.	
MSL 1, Lead Finish Au	

DEVELOPED FREQUENCIES	
Abbreviation	Frequency (MHZ)
120	12.000
160	16.000
192	19.200
200	20.000
240	24.000
245.7	24.576
250	25.000
260	26.000
270	27.000
300	30.000
320	32.000
360	36.000
400	40.000
480	48.000



Figure 1) Suggested Reflow Profile

Mouser Electronics

Authorized Distributor

Click to View Pricing, Inventory, Delivery & Lifecycle Information:

ECS:

[ECS-400-8-36CKM-TR](#) [ECS-260-8-36CKM-TR](#) [ECS-200-8-36CKM-TR](#) [ECS-270-8-36CKM-TR](#) [ECS-250-8-36CKM-TR](#) [ECS-320-8-36CKM-TR](#) [ECS-160-8-36CKM-TR](#) [ECS-300-8-36CKM-TR](#) [ECS-192-8-36CKM-TR](#) [ECS-360-8-36CKM-TR](#) [ECS-240-8-36CKM-TR](#) [ECS-245.7-8-36CKM-TR](#) [ECS-184-8-36CKM-TR](#) [ECS-480-8-36CKM-TR](#) [ECS-196-8-36CKM-TR](#) [ECS-143-8-36CKM-TR](#) [ECS-135-8-36CKM-TR](#) [ECS-800-8-36CKM-TR](#) [ECS-200-10-36-JGN-TR](#) [ECS-160-10-36-JTM-TR](#) [ECS-240-10-36-JGN-TR](#) [ECS-160-10-36-JGN-TR](#) [ECS-200-10-36-JTM-TR](#) [ECS-240-10-36-JTM-TR](#) [ECS-192-10-36-JGN-TR](#) [ECS-300-10-36-JGN-TR](#) [ECS-320-10-36-JGN-TR](#) [ECS-160-8-36-RWN-TR](#) [ECS-480-8-36-RWN-TR](#) [ECS-320-8-36-RWN-TR](#) [ECS-240-8-36-RWN-TR](#) [ECS-250-8-36-RWN-TR](#) [ECS-300-8-36-RWN-TR](#) [ECS-245.7-8-36-RWN-TR](#) [ECS-260-8-36-RWN-TR](#) [ECS-200-8-36-RWN-TR](#) [ECS-184.3-8-36-RWN-TR](#) [ECS-192.0-8-36-RWN-TR](#) [ECS-270-8-36-RWN-TR](#) [ECS-240-10-36-CKM-TR](#) [ECS-384-8-36-CKY-TR](#) [ECS-260-10-36-CKM-TR](#) [ECS-271.2-10-36-AGN-TR](#) [ECS-160-18-36-AGM-TR](#) [ECS-120-8-36-CGN-TR](#) [ECS-250-12-36-AGN-TR](#) [ECS-400-10-36-JGN-TR](#) [ECS-200-18-36-AGM-TR](#) [ECS-250-10-36-JGN-TR](#) [ECS-480-10-36-CKL-TR](#) [ECS-260-10-36-JGN-TR](#) [ECS-192-7-36-CKY-TR](#) [ECS-270-10-36-JGN-TR](#) [ECS-184-10-36-JGN-TR](#) [ECS-320-10-36-CTN-TR](#) [ECS-120-8-36-CKM-TR](#) [ECS-260-8-36-CKY-TR](#) [ECS-240-12-36-AGN-TR](#) [ECS-163.84-10-36-JGN-TR](#) [ECS-240-18-36-AGM-TR](#) [ECS-120-12-36-AGN-TR](#) [ECS-400-10-36-CKY-TR](#) [ECS-160-12-36-AGN-TR](#) [ECS-160-10-36-CKM-TR](#) [ECS-250-10-36-CKM-TR](#) [ECS-192-12-36-AGN-TR](#) [ECS-160-8-36-JTN-TR](#) [ECS-271.2-8-36-AGM-TR](#) [ECS-160-8-36-CKY-TR](#) [ECS-260-7-36-CKY-TR](#) [ECS-192-10-36-CKM-TR](#) [ECS-245.7-10-36-JGN-TR](#) [ECS-320-12-36-CKM-TR](#) [ECS-240-8-36-AGM-TR](#) [ECS-320-10-36-CKM-TR](#) [ECS-120-10-36-AGY-TR](#) [ECS-160-20-36-AEL-TR](#) [ECS-160-8-36-AGM-TR](#) [ECS-120-18-36-AGM-TR](#) [ECS-143-18-36-AGM-TR](#) [ECS-160-10-36-CKL-TR](#) [ECS-160-13-36-AEM-TR](#) [ECS-270-10-36-JTM-TR](#) [ECS-270-18-36-AGM-TR](#) [ECS-300-10-36-CKL-TR](#) [ECS-300-10-36-JTM-TR](#) [ECS-320-10-36-CKL-TR](#) [ECS-384-8.5-36-CKY-TR](#) [ECS-240-8-36-AEL-TR](#) [ECS-245.7-10-36-CKL-TR](#) [ECS-245.7-10-36-JTM-TR](#) [ECS-250-10-36-JTM-TR](#) [ECS-250-18-36-AGM-TR](#) [ECS-260-10-36-CKL-TR](#) [ECS-166.666-12-36-AGM-TR](#) [ECS-184-10-36-JTM-TR](#) [ECS-192-10-36-JTM-TR](#) [ECS-200-10-36-CKL-TR](#) [ECS-240-10-36-CKL-TR](#) [ECS-240-20-36-AEL-TR](#)