

AK7



ESD Sensitive



7.0 x 5.0 x 1.8 mm  
RoHS/RoHS II Compliant  
MSL = 1

## Features

- 3rd overtone solution
- Ultra-Low jitter: 75 fs typ RMS (100fs MAX, F= 156.25MHz LVPECL); spurs included
- Frequency range: 100MHz to 220MHz
- Lowest in-class power consumption (16mA Typ LVDS)
- ± 20ppm & ± 25ppm stability (-40 to +85°C) options available (dependent on frequency)
- 3.3V, 2.5V, 1.8V V<sub>dd</sub> supply
- LVPECL, LVDS, & HCSL differential output options
- Output enable standard

## Applications

- Networking & communications
- Gigabit Ethernet
- Fibre Channel
- SONET/SDH
- RF systems, base stations (BTS)
- Datacenter
- PCI Express
- Test & measurement

## Options and Part Identification [Note 1]

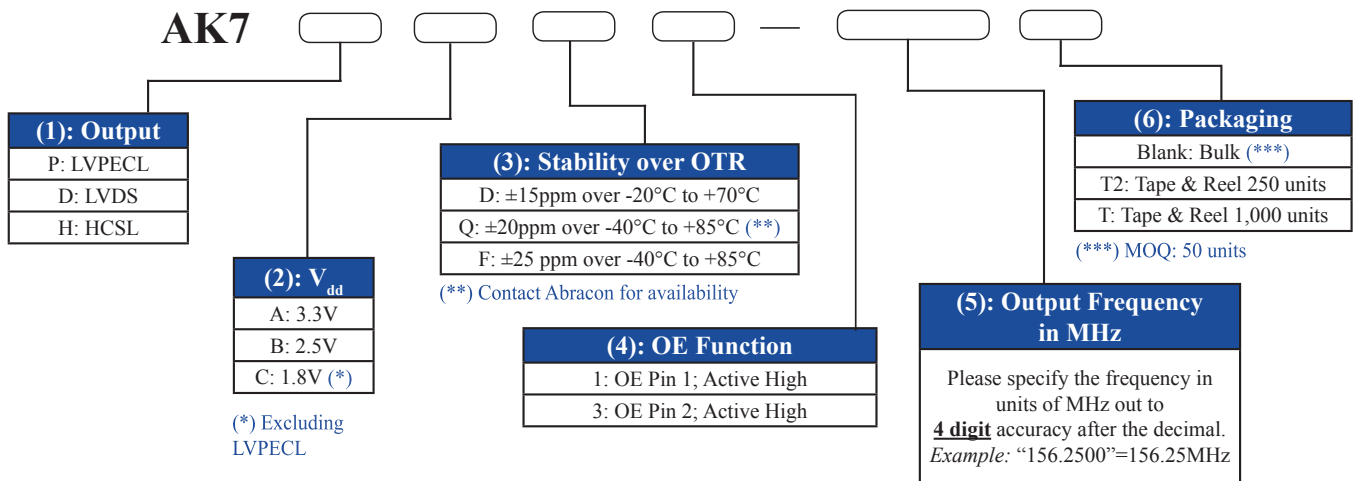

### Part Number Example:

**AK7PAF1-156.2500**

**AK7PAF1-156.2500T2**

**AK7PAF1-156.2500T**

Note 1: Contact Abracon for non-standard part number configurations and/or requests with carrier frequency callouts up to 5 & 6 digit accuracy after the decimal.

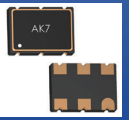

AK7



ESD Sensitive



7.0 x 5.0 x 1.8 mm  
RoHS/RoHS II Compliant  
MSL = 1

## Electrical Characteristics

Parameters		Min.	Typ.	Max.	Unit	Notes
Frequency Range		100		220	MHz	
Standard Available Frequencies		100, 122.88, 125, 148.5 156.25, 200, 212.5			MHz	Contact Abracon for availability of frequencies not listed
Supply Voltage ( $V_{dd}$ ) <sup>[Note 2]</sup>		2.97	3.3	3.63	V	Option "A"
		2.37	2.5	2.62		Option "B"
		1.71	1.8	1.89		Option "C"
Supply Current ( $I_{dd}$ )	LVPECL		30	50	mA	@ 220MHz; @ $V_{dd} = 3.3V$
	LVDS		16	27		@ 220MHz; @ $V_{dd} = 3.3V$
	HCSL		17	30		@ 220MHz; @ $V_{dd} = 3.3V$
Operating Temperature Range		-20		+70	°C	Option "D"
		-40		+85		Option "F" or "Q"
Storage Temperature		-55		+150	°C	
Frequency Accuracy (Initial Set-Tolerance) <sup>[Note 3]</sup> at time of shipment (Pre-Reflow) @ +25°C		-10	< ±5	+10	ppm	Relative to carrier frequency
Frequency Stability over <sup>[Note 4]</sup> Operating Temperature Range		-15		+15	ppm	Option "D" (-20°C to +70°C)
		-20		+20		Option "Q" (-40°C to +85°C)
		-25		+25		Option "F" (-40°C to +85°C)
Aging over 20 Year Product Life <sup>[Note 5]</sup>		-15		+15	ppm	
All-Inclusive Frequency Accuracy (Total Stability) over 20 Year Product Life <sup>[Note 5, 6]</sup>		-40		+40	ppm	Option "D" (-20°C to +70°C)
		-45		+45		Option "Q" (-40°C to +85°C)
		-50		+50		Option "F" (-40°C to +85°C)
Rise (Tr) / Fall (Tf) Time 20% to 80% $V_{peak\ to\ peak}$	LVPECL		0.2	0.4	ns	@ $V_{dd} = 3.3V, R_L = 50\Omega$
			0.3	0.6		@ $V_{dd} = 2.5V, R_L = 50\Omega$
	LVDS		0.15	0.4		@ $V_{dd} = 3.3V, R_L = 100\Omega$
			0.15	0.4		@ $V_{dd} = 2.5V, R_L = 100\Omega$
			0.3	0.5		@ $V_{dd} = 1.8V, R_L = 100\Omega$
	HCSL		0.3	0.5		@ $V_{dd} = 3.3V, R_L = 50\Omega\ to\ GND$
			0.3	0.5		@ $V_{dd} = 2.5V, R_L = 50\Omega\ to\ GND$
			0.3	0.6		@ $V_{dd} = 1.8V, R_L = 50\Omega\ to\ GND$
			0.3	0.6		@ $V_{dd} = 1.8V, R_L = 50\Omega\ to\ GND$
Duty Cycle		45		55	%	
Start-up Time <sup>[Note 3]</sup>			< 2	5.0	ms	

Note 2: Supply Voltage ( $V_{dd}$ ) = 1.8V option not available with LVPECL output

Note 3: Relative to initial measured frequency @ +25°C

Note 4: Option Q only available in select frequencies. Please contact Abracon for availability

Note 5: Relative to post-reflow frequency

Note 6: Includes temperature stability, initial frequency accuracy, load pulling, power supply variation, and 20-year aging

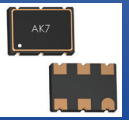

AK7



ESD Sensitive



7.0 x 5.0 x 1.8 mm  
RoHS/RoHS II Compliant  
MSL = 1

## Electrical Characteristics Cont.

Parameters		Min.	Typ.	Max.	Unit	Notes	
Differential Output High Voltage ( $V_{OH}$ ) Output Low Voltage ( $V_{OL}$ )	LVPECL	$V_{OH}$	$V_{dd}-1.03$		$V_{dd}-0.88$	V $R_L=50\Omega$ to $V_{dd}-2.0V$ $R_L=100\Omega$ between both outputs $R_L=50\Omega$ to ground on each output	
		$V_{OL}$	$V_{dd}-1.85$		$V_{dd}-1.60$		
	LVDS	$V_{OH}$		1.40	1.60		
		$V_{OL}$	0.90	1.10			
	HCSL	$V_{OH}$	0.40	0.74	0.85		
		$V_{OL}$	-0.15	0.00	0.15		
Output Voltage Swing			0.595	0.75	0.93	V LVPECL	
			0.25	0.35	0.45	LVDS	
			0.620	0.70	0.78	HCSL	
Output Enable & Disable Control			$0.7*(V_{dd})$			V Output Enable; or No Connect	
					$0.3*(V_{dd})$	Output Disable; High Impedance	
Output Enable Time			< 1	5.0	ms		
Output Disable Time				0.2	$\mu s$		
Output Disable Current Consumption				< 10	$\mu A$	$OE \leq 0.3V$	
RMS Phase Jitter [Note 7, 8, 9] @ +25°C (12kHz-20MHz BW)	@ 200 MHz	LVPECL		70	95	fsec	@ $V_{dd}=3.3V$
				80	105		@ $V_{dd}=2.5V$
		LVDS		125	150		@ $V_{dd}=3.3V$
				150	175		@ $V_{dd}=2.5V$
		HCSL		120	145		@ $V_{dd}=3.3V$
				135	160		@ $V_{dd}=2.5V$
	@ 156.25 MHz	LVPECL		75	100		@ $V_{dd}=3.3V$
				80	105		@ $V_{dd}=2.5V$
		LVDS		90	115		@ $V_{dd}=3.3V$
				80	105		@ $V_{dd}=2.5V$
		HCSL		110	135		@ $V_{dd}=3.3V$
				115	140		@ $V_{dd}=2.5V$

Note 7: Guaranteed by characterization; RMS Phase Jitter specifications are inclusive of any spurs  
 Note 8: Phase jitter measured with Keysight E5052B Signal Source Analyzer  
 Note 9: Refer to the next section for phase noise test setup and representative phase noise plots

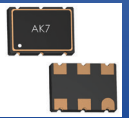

AK7



ESD Sensitive



7.0 x 5.0 x 1.8 mm  
RoHS/RoHS II Compliant  
MSL = 1

## Electrical Characteristics Cont.

Parameters		Min.	Typ.	Max.	Unit	Notes	
RMS Phase Jitter <sup>[Note 7, 8, 9]</sup> @ +25°C (12kHz-20MHz BW)	@ 148.5 MHz	LVPECL		115	140	fsec	@ V <sub>dd</sub> =3.3V
				95	120		@ V <sub>dd</sub> =2.5V
		LVDS		125	150		@ V <sub>dd</sub> =3.3V
				120	145		@ V <sub>dd</sub> =2.5V
		HCSL		130	155		@ V <sub>dd</sub> =3.3V
				135	160		@ V <sub>dd</sub> =2.5V
	@ 125 MHz	LVPECL		100	125	fsec	@ V <sub>dd</sub> =3.3V
				100	125		@ V <sub>dd</sub> =2.5V
		LVDS		150	175		@ V <sub>dd</sub> =3.3V
				110	135		@ V <sub>dd</sub> =2.5V
		HCSL		140	165		@ V <sub>dd</sub> =1.8V
				135	160		@ V <sub>dd</sub> =3.3V
	@ 122.88 MHz	LVPECL		150	175	fsec	@ V <sub>dd</sub> =3.3V
				155	180		@ V <sub>dd</sub> =2.5V
		LVDS		130	155		@ V <sub>dd</sub> =3.3V
				115	140		@ V <sub>dd</sub> =2.5V
		HCSL		165	190		@ V <sub>dd</sub> =1.8V
				135	160		@ V <sub>dd</sub> =3.3V
	@ 100 MHz	LVDS		155	180	fsec	@ V <sub>dd</sub> =2.5V
				145	170		@ V <sub>dd</sub> =3.3V
		HCSL		120	145		@ V <sub>dd</sub> =2.5V
				155	180		@ V <sub>dd</sub> =1.8V

Note 7: Guaranteed by characterization; RMS Phase Jitter specifications are inclusive of any spurs  
 Note 8: Phase jitter measured with Keysight E5052B Signal Source Analyzer  
 Note 9: Refer to the next section for phase noise test setup and representative phase noise plots

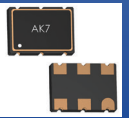

AK7



ESD Sensitive



7.0 x 5.0 x 1.8 mm  
RoHS/RoHS II Compliant  
MSL = 1

## Phase Noise Test Setup <sup>[Note 10]</sup>

- Keysight E5052B Signal Source Analyzer
- Integration Bandwidth = 12kHz to 20MHz
- Spurious Activity (entire plot trace) = NOT Omitted (Normalized in dBc/Hz)
- Specified Spur Omission Function = NOT Enabled
- IF Gain = 20dB
- Correlation = 5
- Average = 3

F=156.2500MHz | V<sub>dd</sub>=3.3V | LVPECL  
RMS Phase Jitter = 69 fsec

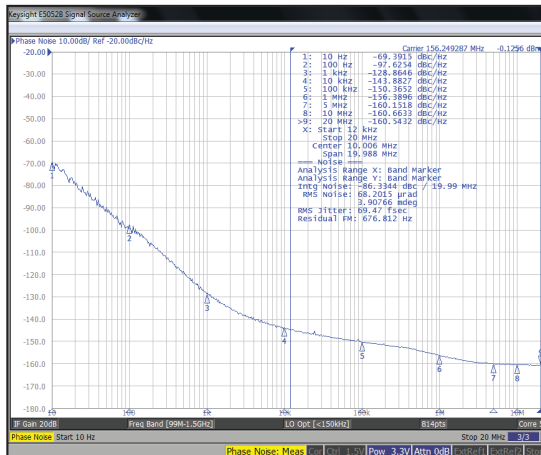

F=156.2500MHz | V<sub>dd</sub>=2.5V | LVPECL  
RMS Phase Jitter = 77 fsec

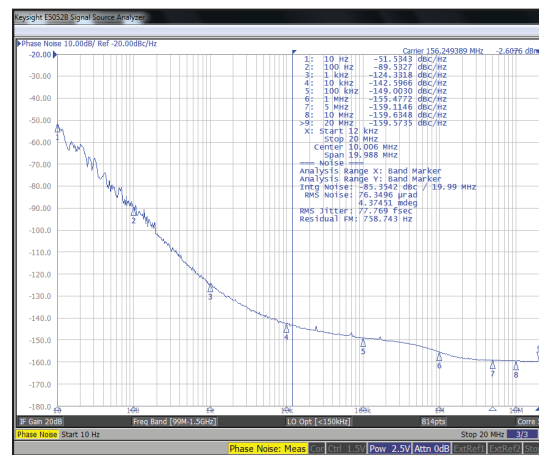

F=156.2500MHz | V<sub>dd</sub>=3.3V | LVDS  
RMS Phase Jitter = 88 fsec

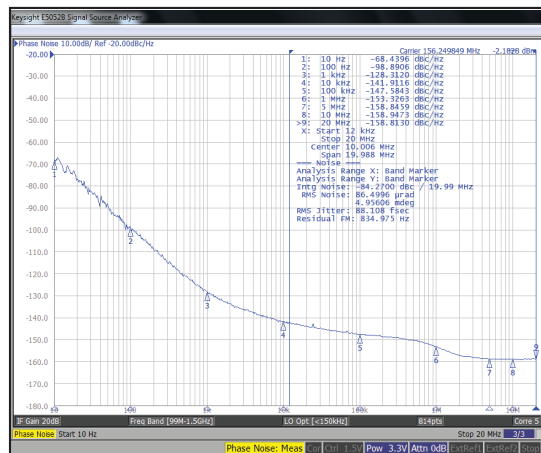

F=156.2500MHz | V<sub>dd</sub>=2.5V | LVDS  
RMS Phase Jitter = 79 fsec

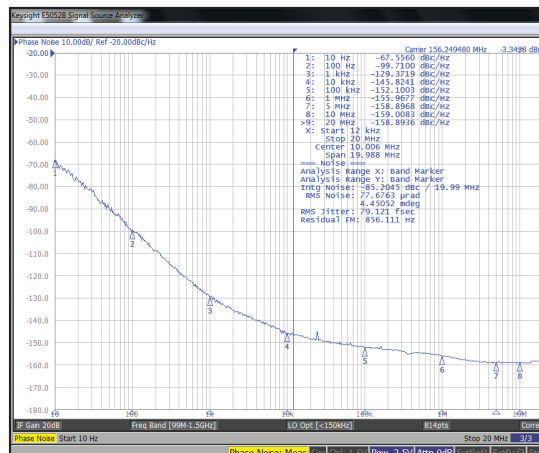

Note 10: Contact Abracon for phase noise plots at alternative supply voltage (V<sub>dd</sub>) & differential output formats.

# ClearClock™ | Ultra-Low Jitter 7.0 x 5.0mm XO

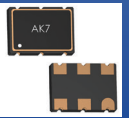

AK7



ESD Sensitive



7.0 x 5.0 x 1.8 mm  
RoHS/RoHS II Compliant  
MSL = 1

## Representative Phase Noise Plots @ +25°C [Note 10]

F=156.2500MHz |  $V_{dd}$ =3.3V | HCSSL  
RMS Phase Jitter = 103 fsec

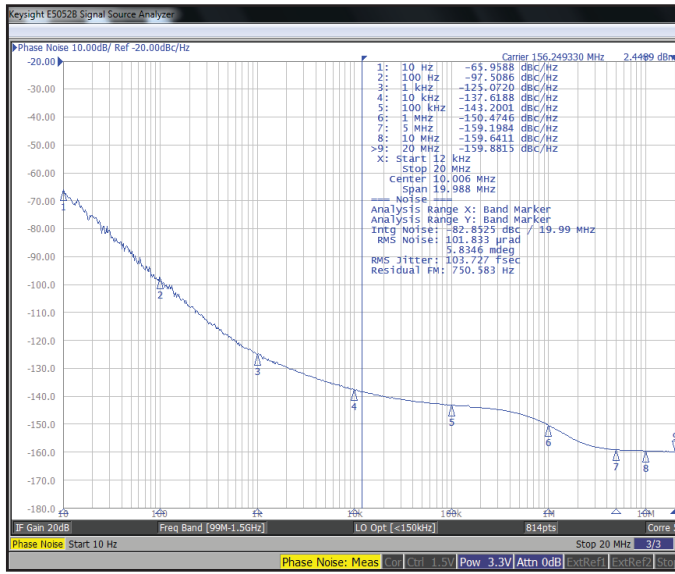

F=156.2500MHz |  $V_{dd}$ =2.5V | HCSSL  
RMS Phase Jitter = 109 fsec

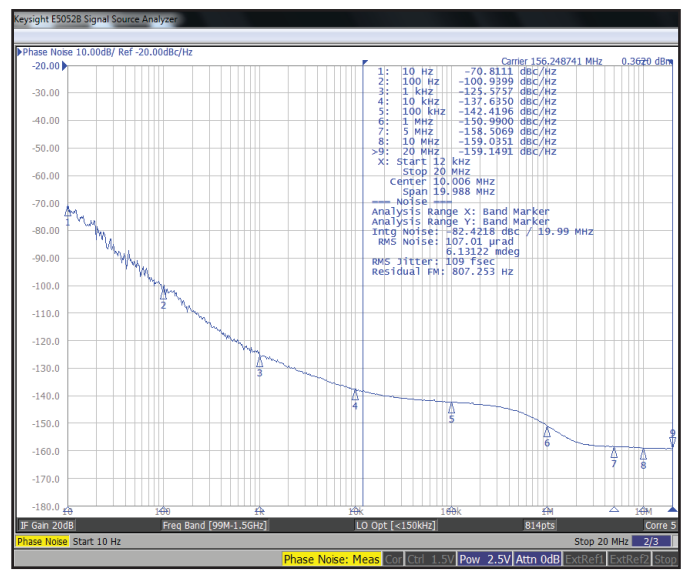

F=125.0000MHz |  $V_{dd}$ =3.3V | LVPECL  
RMS Phase Jitter = 88 fsec

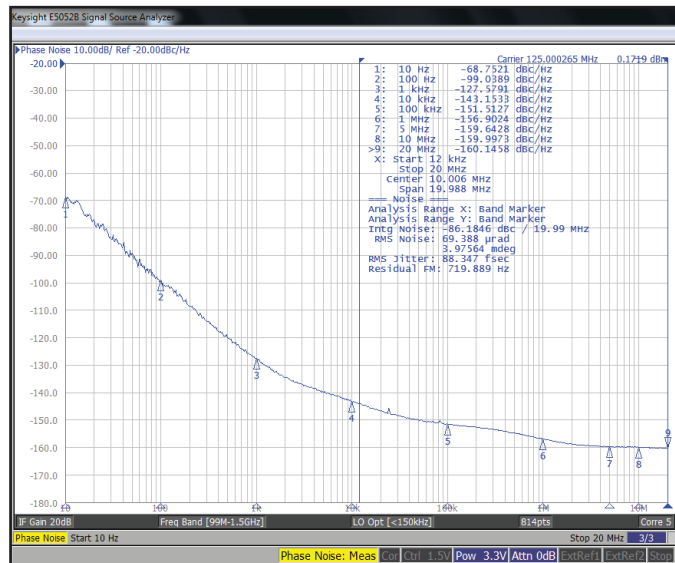

F=125.0000MHz |  $V_{dd}$ =1.8V | LVDS  
RMS Phase Jitter = 136 fsec

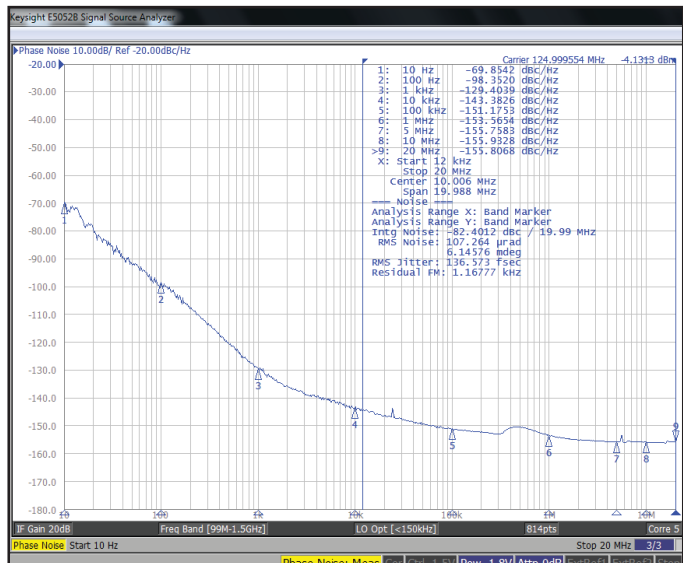

Note 10: Contact Abracon for phase noise plots at alternative supply voltage ( $V_{dd}$ ) & differential output formats.



5101 Hidden Creek Ln Spicewood TX 78669  
Phone: 512-371-6159 | Fax: 512-351-8858  
For terms and conditions of sales, please visit:  
www.abracon.com

REVISED: 04.15.2019

ABRACON IS  
ISO9001-2015  
CERTIFIED

# ClearClock™ | Ultra-Low Jitter 7.0 x 5.0mm XO

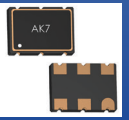

AK7



ESD Sensitive



7.0 x 5.0 x 1.8 mm  
RoHS/RoHS II Compliant  
MSL = 1

## Representative Phase Noise Plots @ +25°C Cont. [Note 10]

F= 100.000MHz | V<sub>dd</sub>=3.3V | HCSL  
RMS Phase Jitter = 131 fsec

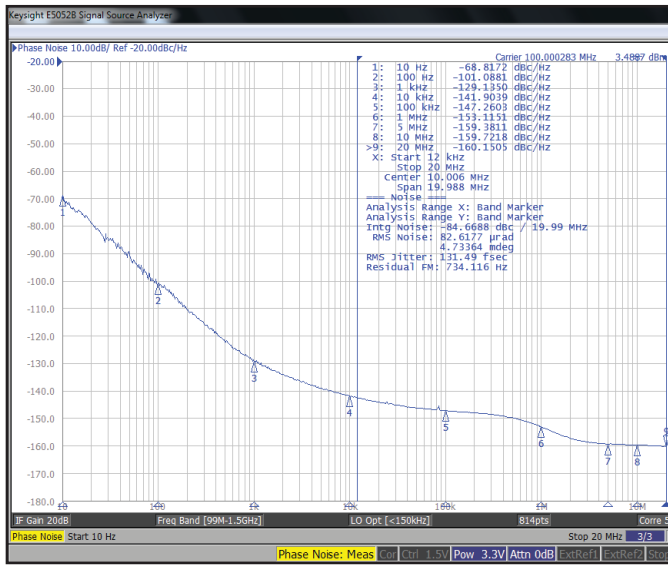

F=100.000MHz | V<sub>dd</sub>=2.5V | HCSL  
RMS Phase Jitter = 114 fsec

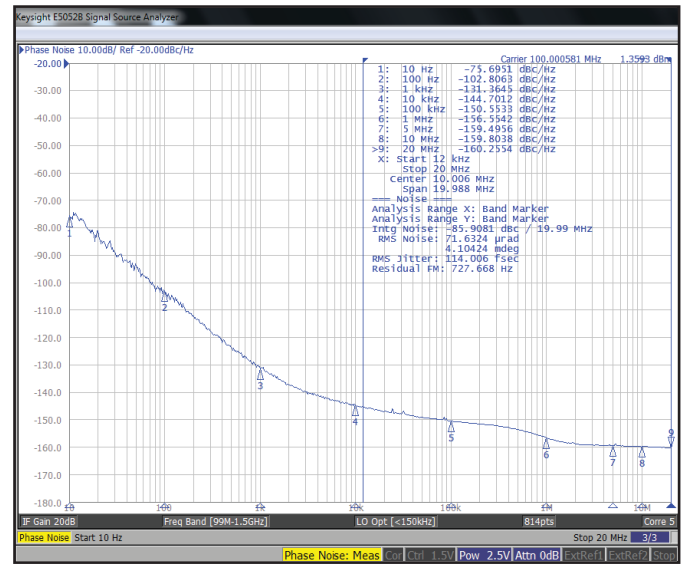

F=148.5000MHz | V<sub>dd</sub>=3.3V | LVPECL  
RMS Phase Jitter = 114 fsec

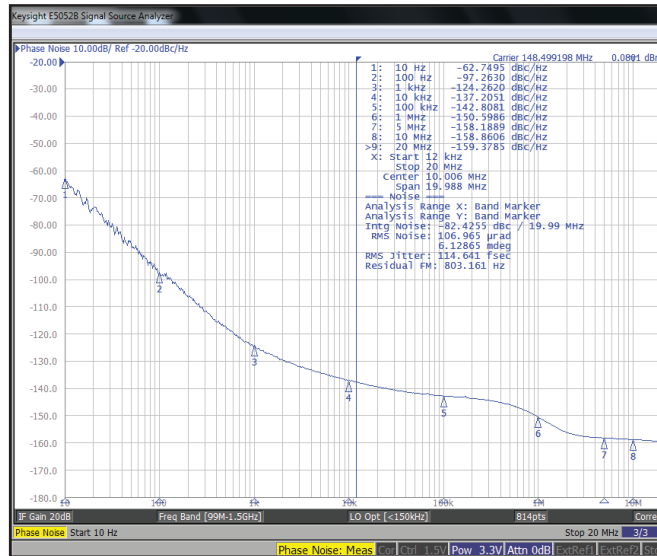

Note 10: Contact Abracon for phase noise plots at alternative supply voltage (V<sub>dd</sub>) & differential output formats.



5101 Hidden Creek Ln Spicewood TX 78669  
Phone: 512-371-6159 | Fax: 512-351-8858  
For terms and conditions of sales, please visit:  
www.abracon.com

REVISED: 04.15.2019

ABRACON IS  
ISO9001-2015  
CERTIFIED

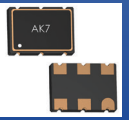

AK7



ESD Sensitive



7.0 x 5.0 x 1.8 mm  
RoHS/RoHS II Compliant  
MSL = 1

Typical Frequency vs. Temperature Characteristics

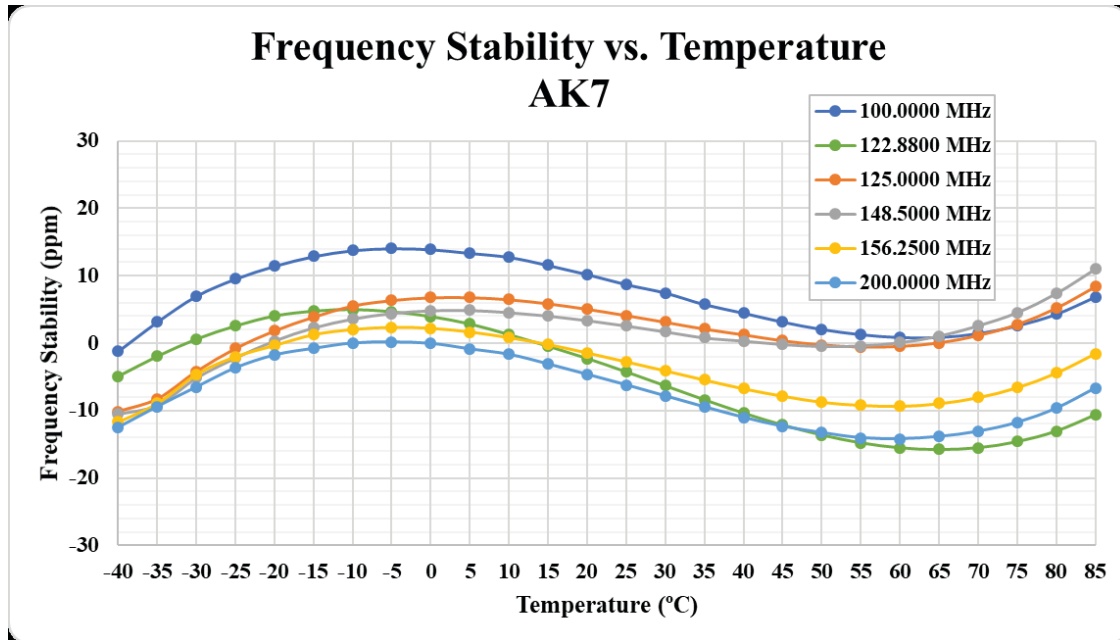

Differential Output Waveform

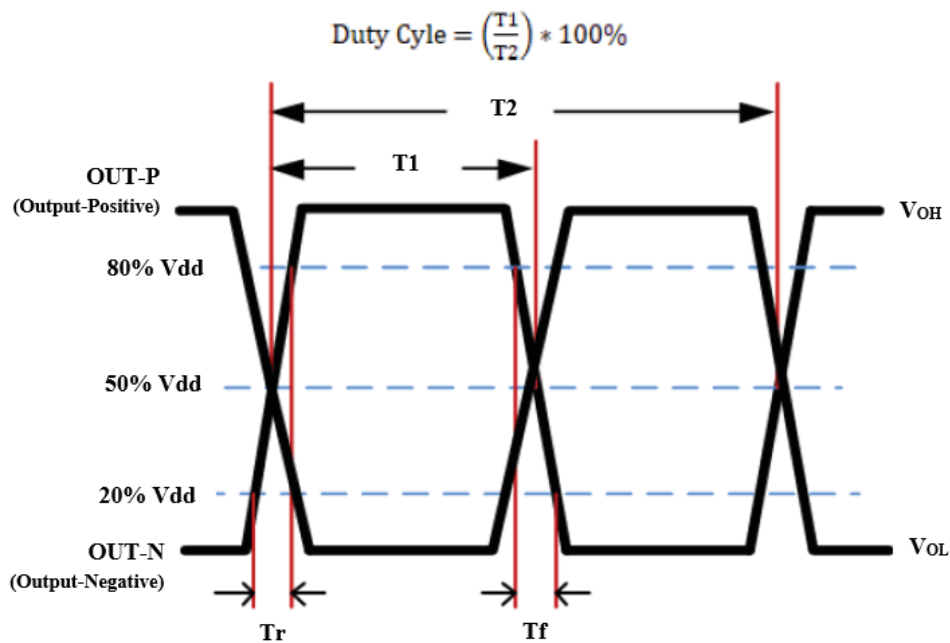



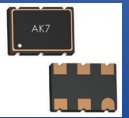

AK7



ESD Sensitive



7.0 x 5.0 x 1.8 mm  
RoHS/RoHS II Compliant  
MSL = 1

## Recommended Test Circuit <sup>[Note 11]</sup>

### LVPECL

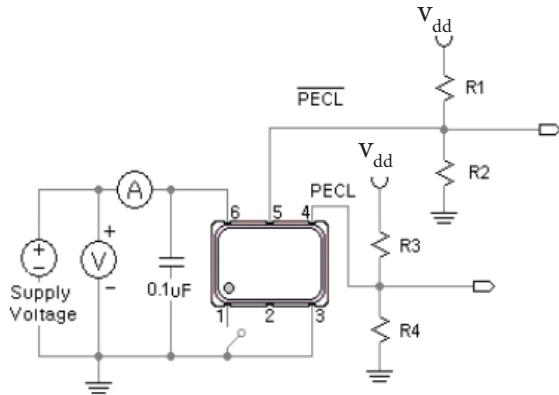

$V_{dd} = 3.3V$ :  $R1=R3=127\Omega$ ;  $R2=R4=82.5\Omega$   
 $V_{dd} = 2.5V$ :  $R1=R3=250\Omega$ ;  $R2=R4=62.5\Omega$

### LVDS

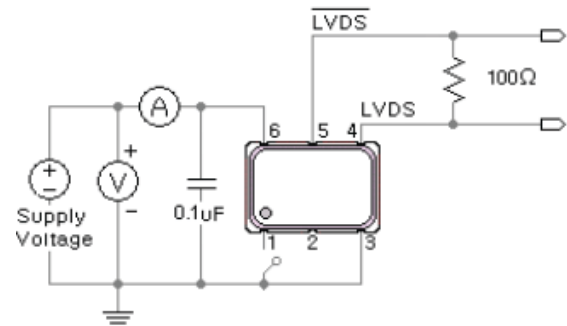

### HCSL

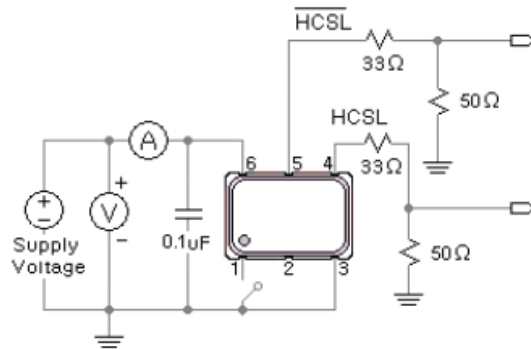

Note 11: Recommended test circuit images are representative of when the OE Function is located on Pin 1; when the OE Function is located on Pin 2, then Pin 1=No Connect & Pin 2=OE or No Connect.

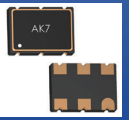

AK7



ESD Sensitive



7.0 x 5.0 x 1.8 mm  
RoHS/RoHS II Compliant  
MSL = 1

## Mechanical Dimensions

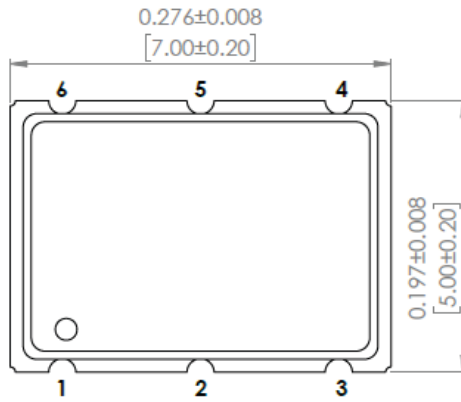

TOP VIEW

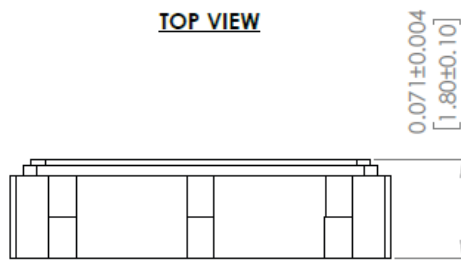

SIDE VIEW

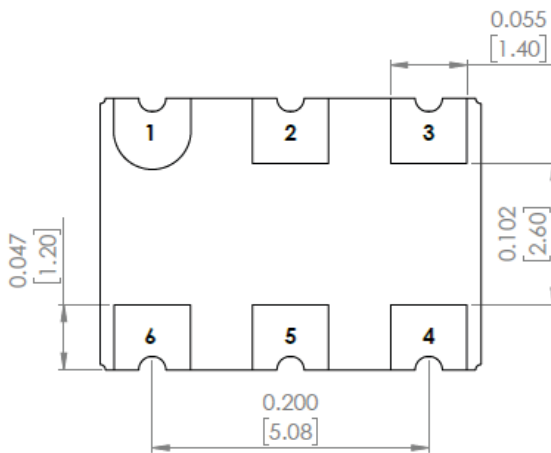

BOTTOM VIEW

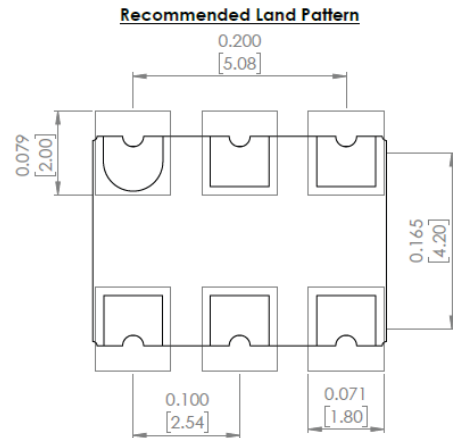

Case 1 Pin #1=Output Enable/Disable Function where OE is Active HIGH		Case 2 Pin #2=Output Enable/Disable Function where OE is Active HIGH	
Pin	Description	Pin	Description
# 1	Output Enable = Logic High, "1", V <sub>dd</sub>	# 1	No Connect
	Output Disable = Logic Low, "0", GND	# 2	Output Enable = Logic High, "1", V <sub>dd</sub>
# 2	No Connect		Output Enable = Logic Low, "0", GND
# 3	GND	# 3	GND
# 4	Output	# 4	Output
# 5	Complementary output	# 5	Complementary output
# 6	Supply Voltage (V <sub>dd</sub> )	# 6	Supply Voltage (V <sub>dd</sub> )

Dimensions: inches [mm]

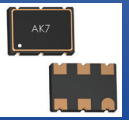

AK7



ESD Sensitive



7.0 x 5.0 x 1.8 mm  
RoHS/RoHS II Compliant  
MSL = 1

## Recommended Reflow Profile [Note 12]

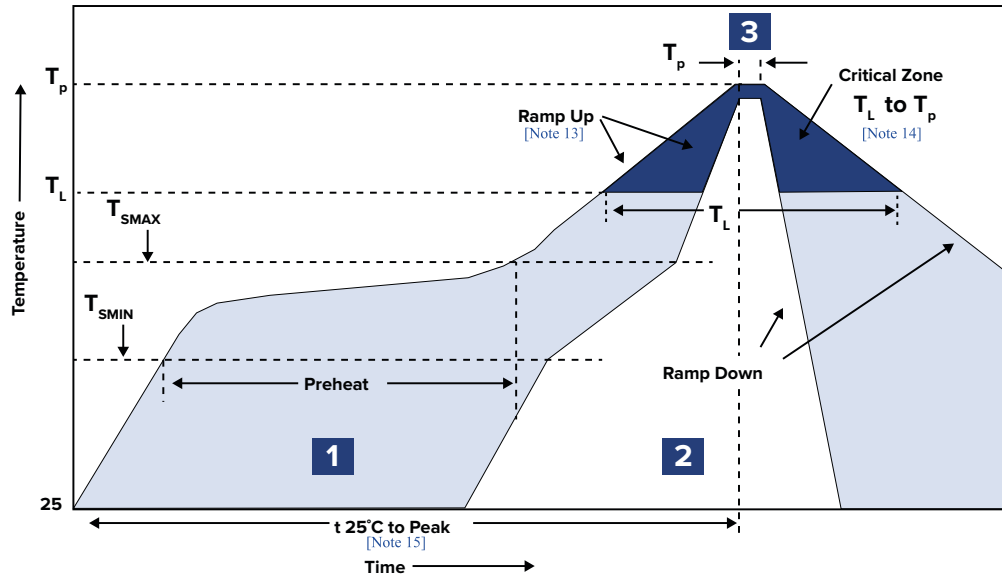

Zone	Description	Temperature	Time
1	Preheat / Soak	$T_{SMIN} \sim T_{SMAX}$ 150°C ~ 200°C	60 ~ 180 sec.
2	Reflow	$T_L$ 217°C	60 ~ 150 sec.
3	Peak heat	$T_P$ 260°C±5°C	20 ~ 40 sec.

Note 12: Can withstand: 2 reflows

Note 13: Ramp Up Rate ( $T_L \rightarrow T_P$ ) = 3°C / sec. MAX

Note 14: Ramp Down Rate ( $T_P \rightarrow T_L$ ) = 6°C / sec. MAX

Note 15: Time 25°C to Peak Temperature (25°C  $\rightarrow$   $T_P$ ) = 8 minutes MAX

All temperatures refer to topside of the package, measured on the package body surface.

# ClearClock™ | Ultra-Low Jitter 7.0 x 5.0mm XO

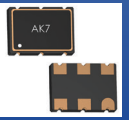

AK7



ESD Sensitive



7.0 x 5.0 x 1.8 mm  
RoHS/RoHS II Compliant  
MSL = 1

## Packaging

Bulk (MOQ = 50 units)  
T2 = Tape & Reel 250 units/reel  
T = Tape & Reel 1,000 units/reel

Feeding (PULL) Direction →

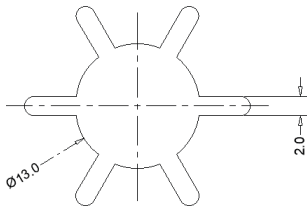
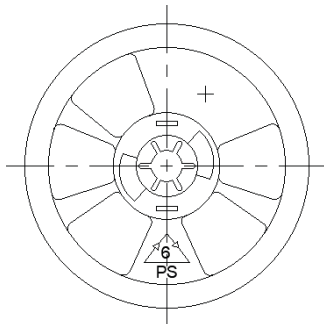
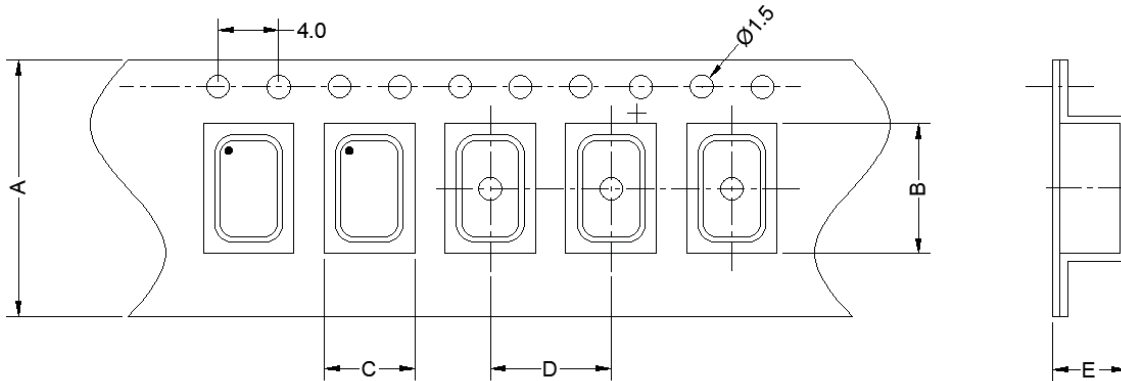

### Tape Dimensions

A	16.0
B	7.2
C	5.4
D	8.0
E	1.8

### Reel Dimensions

F	180.0
G	16.5
H	19.6

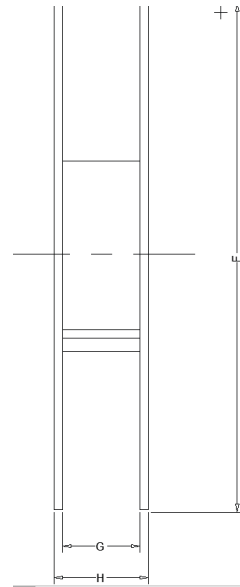

Dimensions: mm

**ATTENTION:** Abracon LLC's products are COTS – Commercial-Off-The-Shelf products; suitable for Commercial, Industrial and, where designated, Automotive Applications. Abracon's products are not specifically designed for Military, Aviation, Aerospace, Life-dependent Medical applications or any application requiring high reliability where component failure could result in loss of life and/or property. For applications requiring high reliability and/or presenting an extreme operating environment, written consent and authorization from Abracon LLC is required. Please contact Abracon LLC for more information.



5101 Hidden Creek Ln Spicewood TX 78669  
Phone: 512-371-6159 | Fax: 512-351-8858  
For terms and conditions of sales, please visit:  
[www.abracon.com](http://www.abracon.com)

REVISED: 04.15.2019

ABRACON IS  
ISO9001-2015  
CERTIFIED

# Mouser Electronics

Authorized Distributor

Click to View Pricing, Inventory, Delivery & Lifecycle Information:

## ABRACON:

[AK7HAF1-156.2500](#) [AK7PBF1-156.2500](#) [AK7DBF1-200.0000](#) [AK7DBF1-125.0000](#) [AK7PAF1-148.5000T2](#)  
[AK7HBF1-200.0000](#) [AK7DBF1-156.2500T2](#) [AK7PAF1-122.8800T2](#) [AK7HAF1-156.2500T2](#) [AK7PAF1-125.0000T2](#)  
[AK7DBF1-156.2500](#) [AK7DBF1-200.0000T2](#) [AK7DCF1-122.8800](#) [AK7DAF1-125.0000](#) [AK7DBF1-148.5000](#)  
[AK7HBF1-125.0000](#) [AK7PBF1-125.0000T2](#) [AK7DBF1-100.0000](#) [AK7PAF1-200.0000T2](#) [AK7PBF1-122.8800](#)  
[AK7PBF1-125.0000](#) [AK7HAF1-200.0000](#) [AK7PAF1-148.5000](#) [AK7HAF1-148.5000T2](#) [AK7DAF1-122.8800T2](#)  
[AK7PAF1-156.2500](#) [AK7HBF1-100.0000T2](#) [AK7DAF1-156.2500](#) [AK7HBF1-148.5000T2](#) [AK7DBF1-122.8800T2](#)  
[AK7DCF1-125.0000](#) [AK7PBF1-148.5000T2](#) [AK7DAF1-148.5000](#) [AK7HBF1-100.0000](#) [AK7HBF1-156.2500](#)  
[AK7HBF1-122.8800T2](#) [AK7DAF1-122.8800](#) [AK7PBF1-200.0000](#) [AK7HAF1-122.8800T2](#) [AK7DBF1-122.8800](#)  
[AK7DAF1-156.2500T2](#) [AK7HCF1-125.0000](#) [AK7HBF1-148.5000](#) [AK7HAF1-100.0000T2](#) [AK7PAF1-156.2500T2](#)  
[AK7PBF1-148.5000](#) [AK7DAF1-125.0000T2](#) [AK7PBF1-156.2500T2](#) [AK7DBF1-125.0000T2](#) [AK7HAF1-100.0000](#)  
[AK7DAF1-200.0000](#) [AK7HCF1-125.0000T2](#) [AK7HBF1-200.0000T2](#) [AK7DCF1-125.0000T2](#) [AK7HAF1-125.0000](#)  
[AK7PAF1-122.8800](#) [AK7HAF1-125.0000T2](#) [AK7PBF1-122.8800T2](#) [AK7HAF1-200.0000T2](#) [AK7HAF1-148.5000](#)  
[AK7DBF1-148.5000T2](#) [AK7DAF1-148.5000T2](#) [AK7PAF1-125.0000](#) [AK7PBF1-200.0000T2](#) [AK7PAF1-200.0000](#)  
[AK7DBF1-100.0000T2](#) [AK7HBF1-156.2500T2](#) [AK7DCF1-122.8800T2](#) [AK7HBF1-125.0000T2](#) [AK7HAF1-122.8800](#)  
[AK7DAF1-200.0000T2](#) [AK7HBF1-122.8800](#)