

Common mode Noise Filters

Type: **EXC14CG**
EXC14CE



Features

- Small and thin (L 0.85 mm×W 0.65 mm×H 0.45 mm)
- Noise suppression of high-speed differential transmission lines with little influence of waveform rounding on signal transmission
- Low DC resistance and low insertion loss
- High-Q value and high impedance of GHz zone : EXC14CG type
- Strong multilayer/sintered structure, excellent reflow resistance and high mounting reliability
- Lead, halogen and antimony-free
- RoHS compliant

Recommended Applications

- Smartphones, Tablet PCs and DSC
- Noise suppression of high-speed differential data lines such as USB, LVDS and MHL

Explanation of Part Numbers

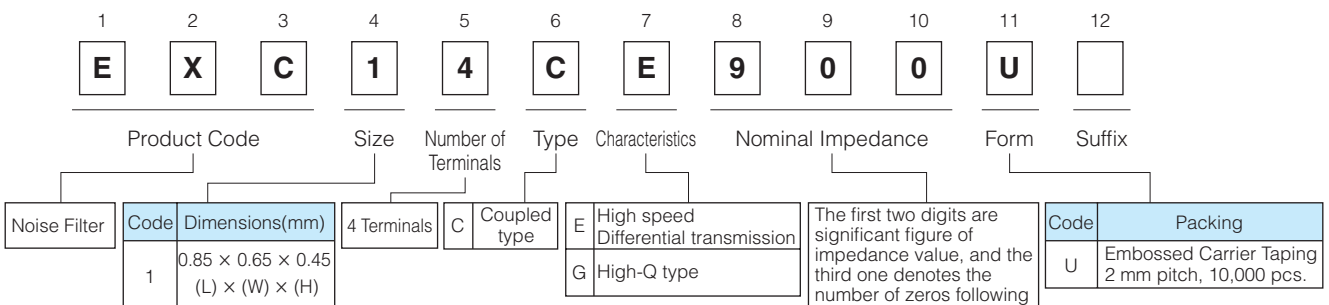

Construction

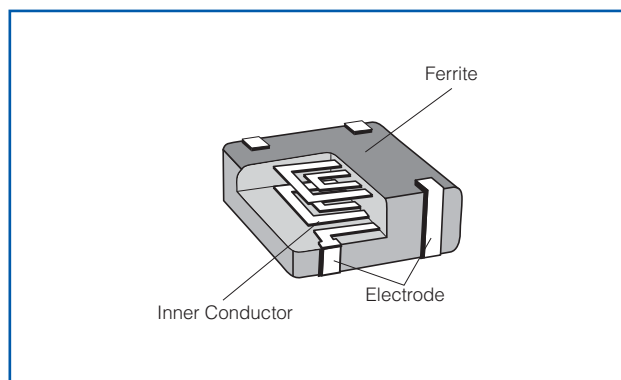

Dimensions in mm (not to scale)

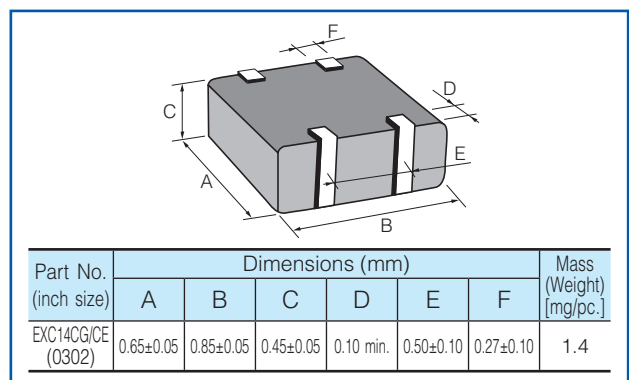

Circuit Configuration(No Polarity)

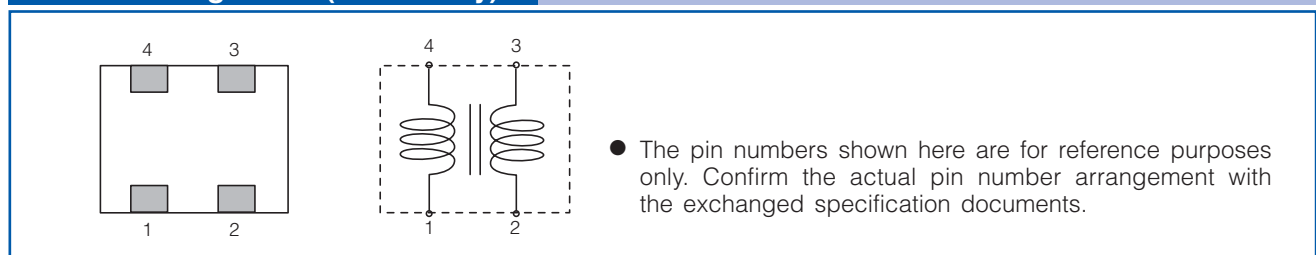

Ratings

Part Number	Impedance (Ω) at 100 MHz		Rated Voltage (V DC)	Rated Current (mA DC)	DC Resistance (Ω)max.
	Common Mode	Differential Mode			
EXC14CG120U	12 $\Omega \pm 30\%$	10 Ω max.	5	130	2.0
EXC14CG350U	35 $\Omega \pm 30\%$	15 Ω max.	5	100	2.0
EXC14CG430U	43 $\Omega \pm 25\%$	15 Ω max.	5	100	2.7
EXC14CE650U	65 $\Omega \pm 20\%$	20 Ω max.	5	130	2.5
EXC14CE900U	90 $\Omega \pm 20\%$	20 Ω max.	5	130	2.5
EXC14CE121U	120 $\Omega \pm 20\%$	20 Ω max.	5	100	3.8

- Category Temperature Range $-40\text{ }^{\circ}\text{C}$ to $+85\text{ }^{\circ}\text{C}$

Impedance Characteristics (Typical)

● EXC14CG120U

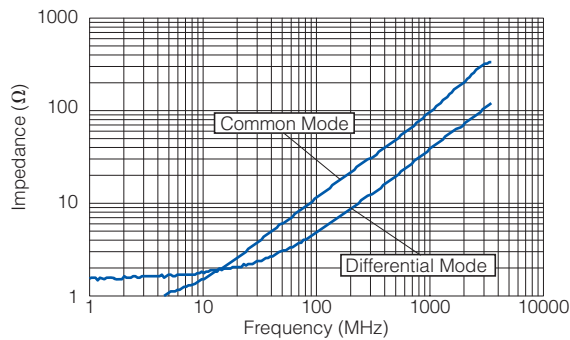

● EXC14CG350U

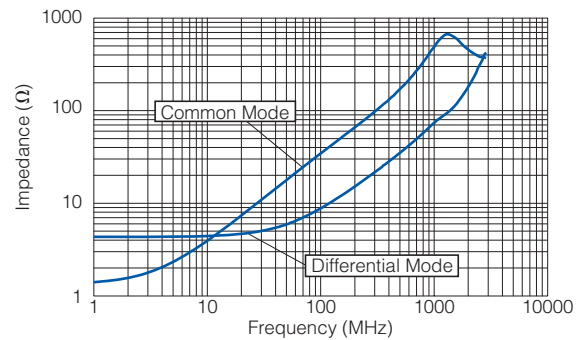

● EXC14CG430U

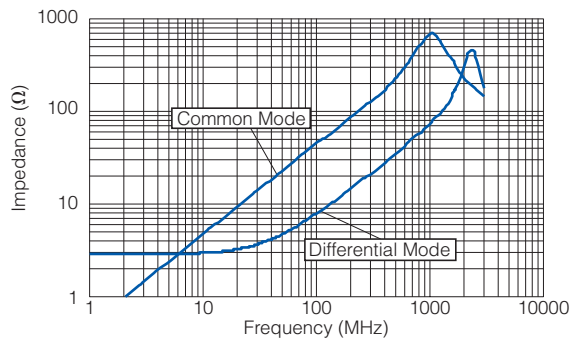

● EXC14CE650U

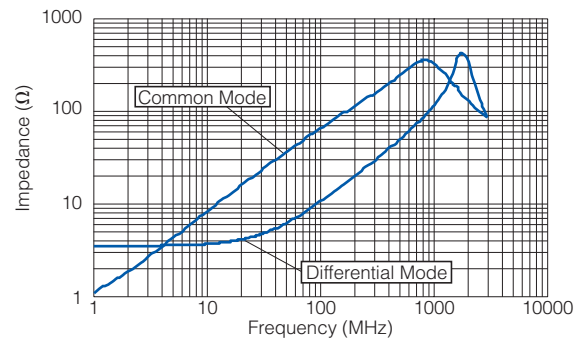

● EXC14CE900U

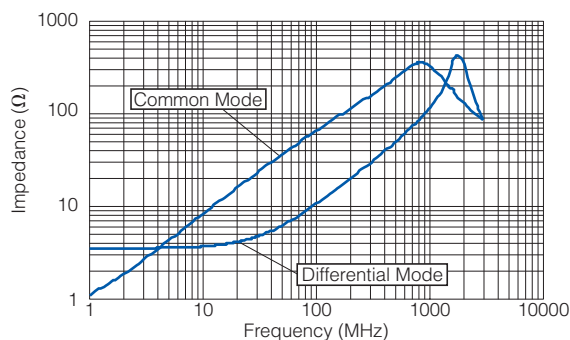

● EXC14CE121U

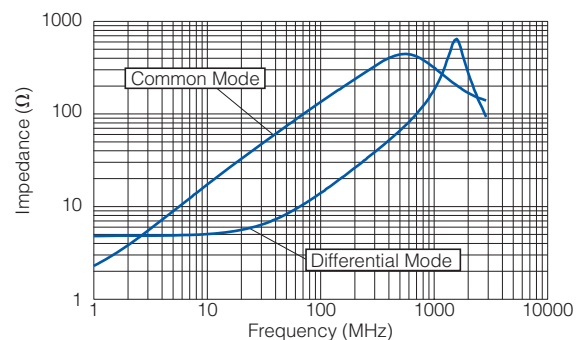

● Measurement Circuit

(A) Common Mode

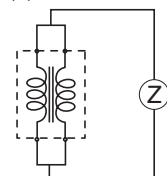

(B) Differential Mode

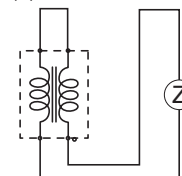

Attenuation Characteristics (Typical)

● EXC14CG120U

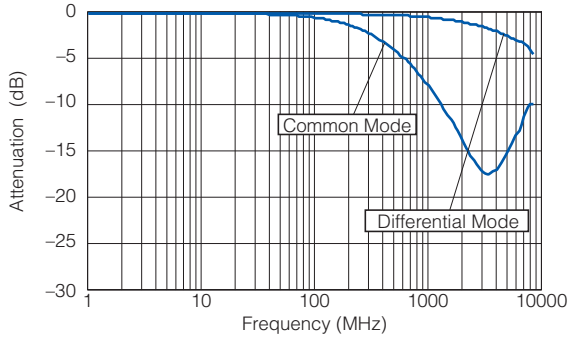

● EXC14CG350U

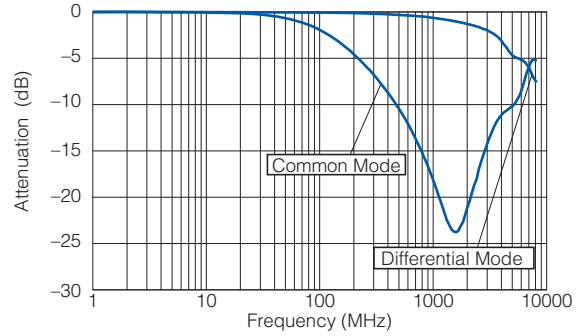

● EXC14CG430U

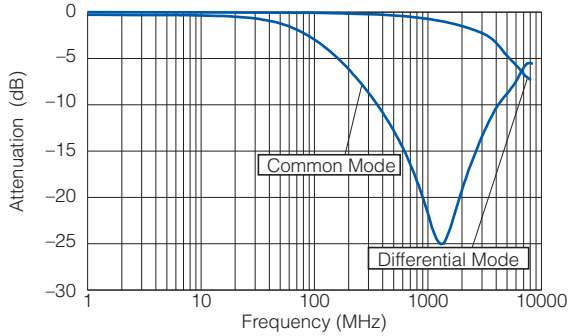

● EXC14CE650U

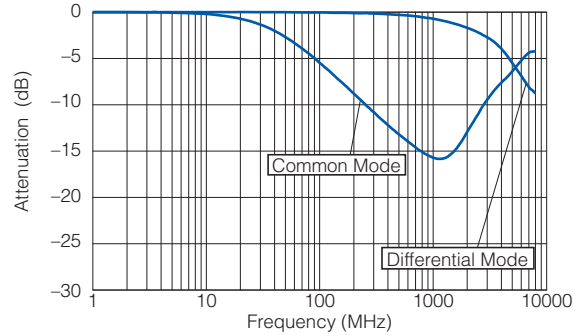

● EXC14CE900U

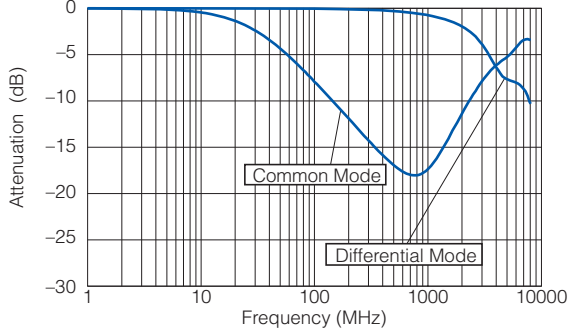

● EXC14CE121U

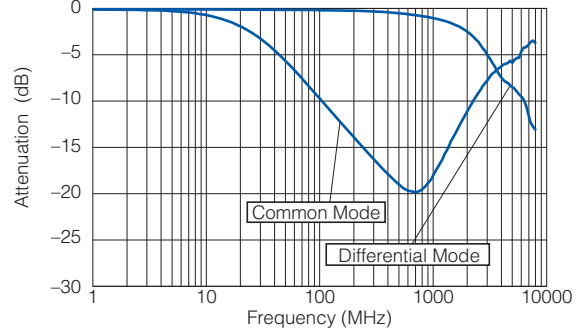

■ As for Packaging Methods, Land Pattern, Soldering Conditions and Safety Precautions, Please see Data Files

Mouser Electronics

Authorized Distributor

Click to View Pricing, Inventory, Delivery & Lifecycle Information:

[Panasonic:](#)

[EXC-14CE900U](#) [EXC-14CE650U](#) [EXC-14CG430U](#) [EXC-14CG120U](#) [EXC-14CG350U](#) [EXC-14CE121U](#)