

AREQ-90C0-00000

3528 PLCC-4 Surface Mount Infrared LED



Description

The Broadcom[®] AREQ-90C0-00000 is a double-junction 850-nm infrared emitter packaged in an industrial-standard PLCC-4. This high-efficiency infrared emitter is suitable to be used in industrial sensing and infrared illumination for cameras.

The package is compatible with the reflow soldering process. To facilitate easy pick-and-place assembly, the products are packed in tape and reel.

Features

- Available in peak wavelength 940 nm
- Wide viewing angle at 120°
- JEDEC MSL 3

Applications

- Infrared illumination for cameras
- Industrial sensing

Figure 1: Package Drawing

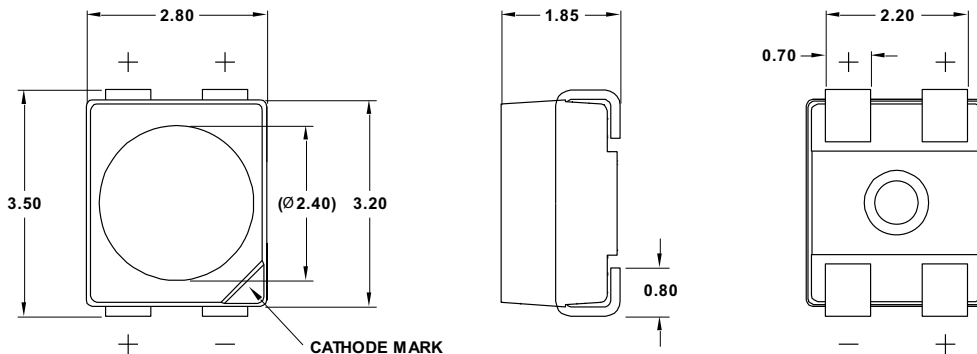

NOTE:

1. All dimensions are in millimeters (mm).
2. Tolerance is ± 0.20 mm unless otherwise specified.
3. Terminal finish = silver plating.
4. Dimensions in bracket are for reference only.

CAUTION! This LED is ESD sensitive. Observe appropriate precautions during handling and processing. Refer to Application Note AN-1142 for additional details.

Device Selection Guide ($T_J = 25^\circ\text{C}$, $I_F = 100\text{ mA}$, $t_p = 20\text{ ms}$)

Part Number	Viewing Angle, $2\theta_{1/2}$ (°)	Peak Wavelength, λ_p (nm)	Radiant Intensity, I_e (mW/sr) ^{a, b}		
	Typ.	Typ.	Min.	Typ.	Max.
AREQ-90C0-00000	120	940	11.2	18.0	45.0

a. The radiant intensity, I_e is measured at the mechanical axis of the package and it is tested with a single current pulse condition. The actual peak of the spatial radiation pattern may not be aligned with the axis.

b. Tolerance is $\pm 15\%$.

Absolute Maximum Ratings

Parameters	AREQ-90C0-00000	Units
DC Forward Current ^a	100	mA
Peak Forward Current ^b	1000	mA
Power Dissipation	200	mW
Reverse Voltage	Not designed for reverse bias operation	
LED Junction Temperature	125	°C
Operating Temperature Range	-40 to +100	°C
Storage Temperature Range	-40 to +100	°C

a. Derate linearly as shown in [Figure 6](#) and [Figure 7](#).

b. Duty factor = 1%, frequency = 100 Hz, $T_s = 25^\circ\text{C}$.

Optical and Electrical Characteristics ($T_J = 25^\circ\text{C}$)

Parameters	Min.	Typ.	Max.	Units	Test Conditions
Viewing Angle, $2\theta_{1/2}$ ^a	—	120	—	°	$I_F = 100\text{ mA}$, $t_p = 20\text{ ms}$
Spectral Half-Width, $\Delta\lambda_{1/2}$	—	41	—	nm	$I_F = 100\text{ mA}$, $t_p = 20\text{ ms}$
Forward Voltage, V_F ^b	—	1.6	2.0	V	$I_F = 100\text{ mA}$, $t_p = 20\text{ ms}$
Forward Voltage, V_F ^b	—	3.1	—	V	$I_F = 1\text{ A}$, $t_p = 100\text{ }\mu\text{s}$
Rise time, t_r ^c	—	20	—	ns	$I_F = 100\text{ mA}$
Fall time, t_f ^c	—	55	—	ns	$I_F = 100\text{ mA}$
Thermal Resistance, $R_{\theta J-S}$ ^d	—	140	—	°C/W	—
Temperature Coefficient of Radiant Intensity, TC_{I_e}	—	-0.25	—	%/°C	$I_F = 100\text{ mA}$, $25^\circ\text{C} \leq T \leq 85^\circ\text{C}$
Temperature Coefficient of Forward Voltage, TC_{V_F}	—	-1.0	—	mV/°C	$I_F = 100\text{ mA}$, $25^\circ\text{C} \leq T \leq 85^\circ\text{C}$
Temperature Coefficient of Peak Wavelength, TC_{λ_p}	—	0.04	—	nm/°C	$I_F = 100\text{ mA}$, $25^\circ\text{C} \leq T \leq 85^\circ\text{C}$

a. $\theta_{1/2}$ is the off-axis angle where the luminous intensity is half of the peak intensity.

b. Forward voltage tolerance is $\pm 0.1\text{ V}$.

c. 10% and 90% of $I_{e\text{ max}}$.

d. Thermal resistance from LED junction to solder point.

Part Numbering System

A R E Q -

x ₁	x ₂	x ₃
----------------	----------------	----------------

 0 - 0 0 0 0 0 0

Code	Description	Option	
x ₁	Peak Wavelength	9	940 nm
x ₂	Viewing Angle	0	120°
x ₃	Junction type	C	Single junction

Part Number Example

AREQ-90C0-00000

- x₁ : 9 – Peak wavelength 940 nm
- x₂ : 0 – 120° viewing angle
- x₃ : C – Single junction type

Bin Information

Radiant Intensity Bin Limits (CAT)

Bin ID	Radiant Intensity, I _e (mW/sr)	
	Min.	Max.
L	11.2	18.0
M	18.0	28.5
N	28.5	45.0

Tolerance = ± 12%.

Figure 2: Spectral Power Distribution

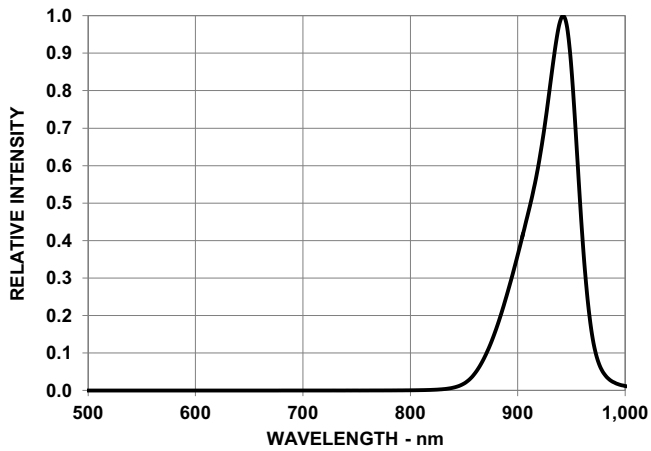

Figure 3: Forward Current vs. Forward Voltage

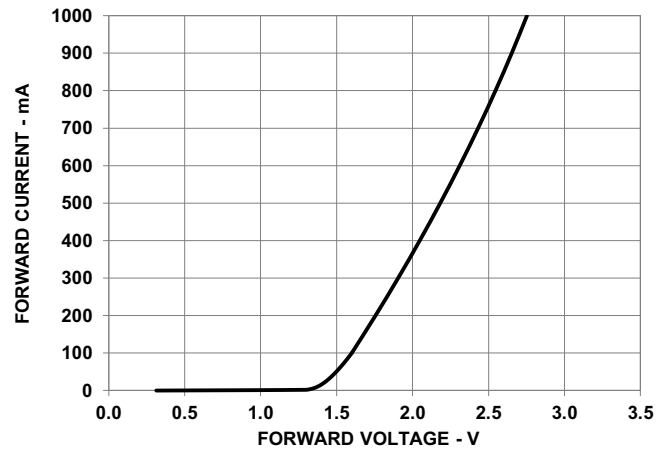

Figure 4: Relative Radiant Intensity vs. Mono Pulse Current

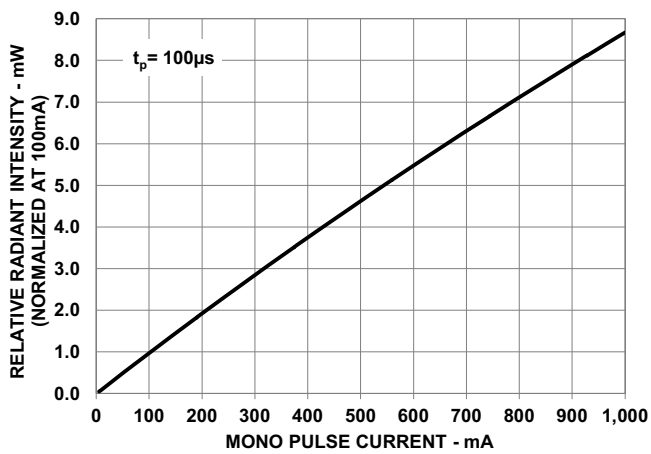

Figure 5: Radiation Pattern

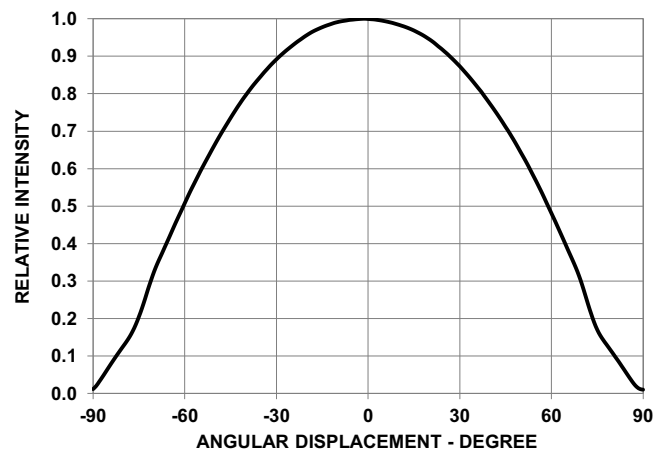

Figure 6: Maximum Forward Current vs. Ambient Temperature. Derated based on $T_{JMAX} = 125^{\circ}C$, $R_{\theta J-A} = 400^{\circ}C/W$, $450^{\circ}C/W$, and $500^{\circ}C/W$

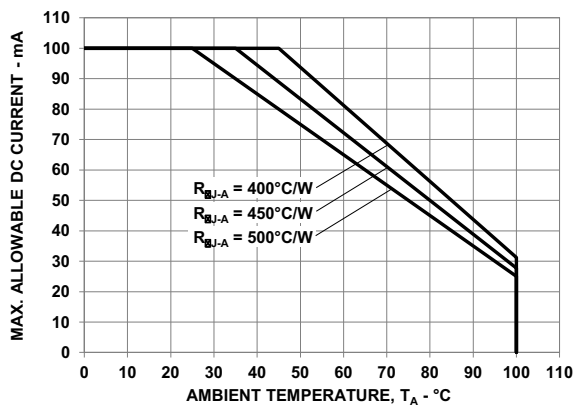

Figure 7: Maximum Forward Current vs. Solder Point Temperature. Derated based on $T_{JMAX} = 125^{\circ}C$, $R_{\theta J-S} = 140^{\circ}C/W$

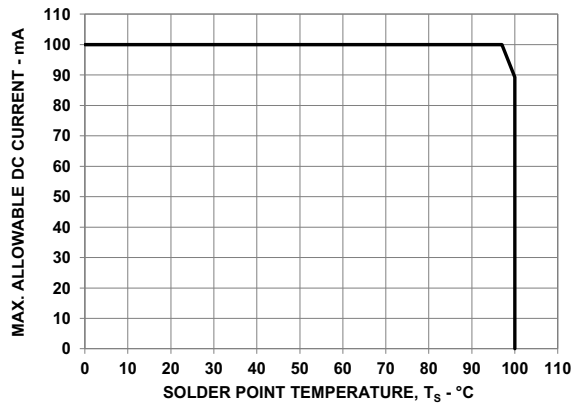

Figure 8: Maximum Pulse Current vs. Ambient Temperature at Ts = 100°C

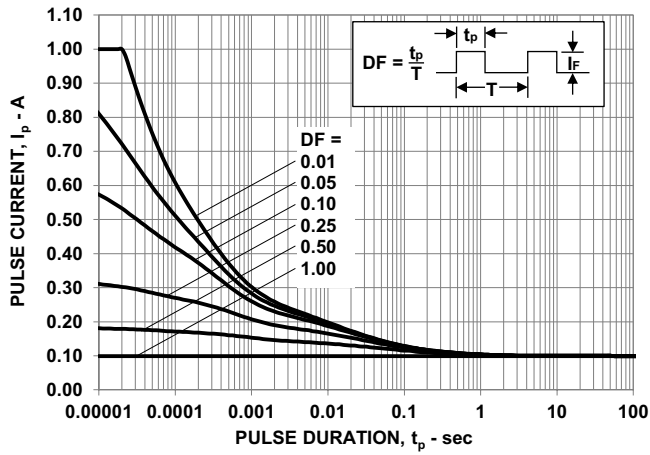
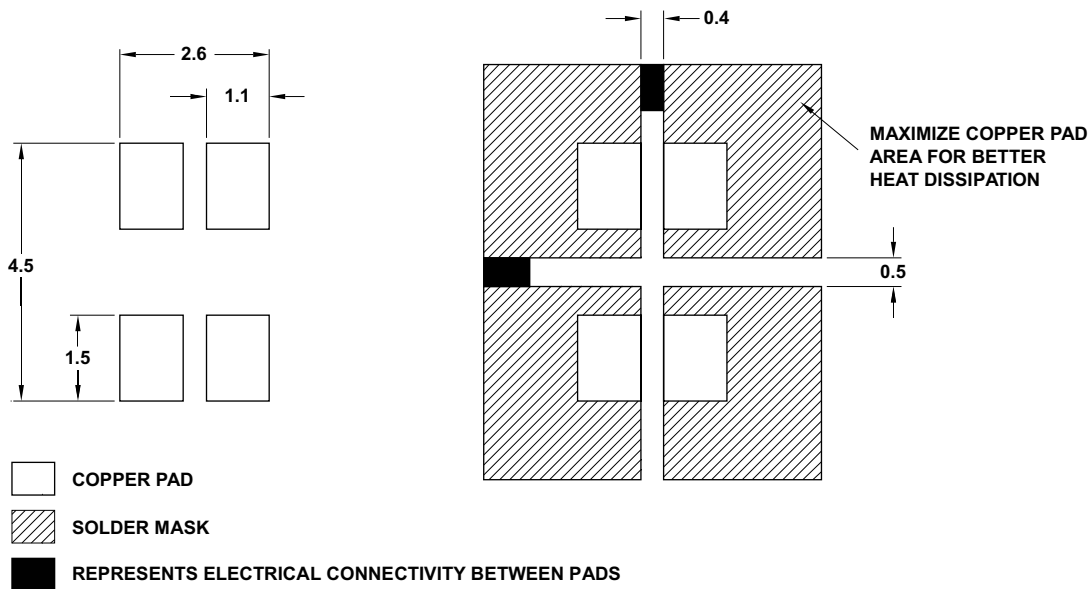
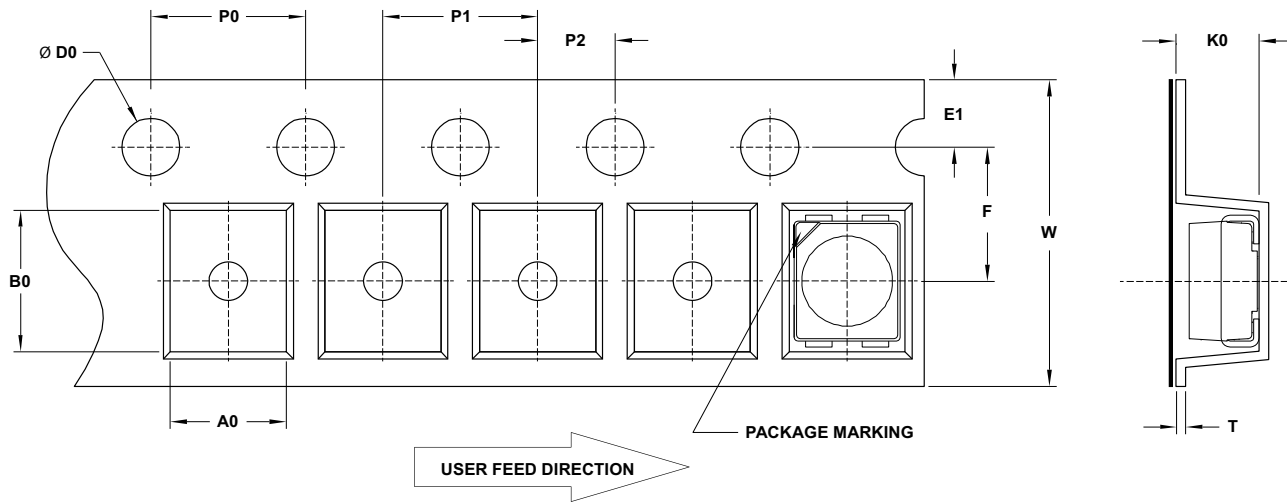

Figure 9: Recommended Soldering Land Pattern



NOTE: All dimensions are in millimeters (mm).

Figure 10: Carrier Tape Dimensions



F	P0	P1	P2	D0	E1	W
3.5 ± 0.05	4.0 ± 0.1	4.0 ± 0.1	2.0 ± 0.05	1.5 + 0.1/-0	1.75 ± 0.1	8.0 + 0.3/-0.1

T	B0	K0	A0
0.25 ± 0.05	3.7 ± 0.1	2.15 ± 0.1	3.0 ± 0.1

NOTE: All dimensions are in millimeters (mm).

Figure 11: Reel Dimensions

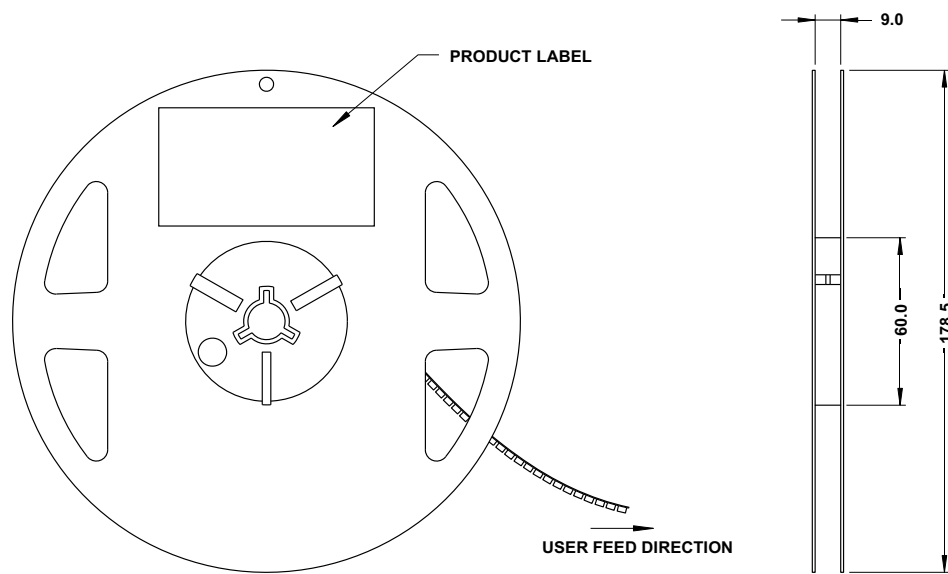

NOTE: All dimensions are in millimeters (mm).

Precautionary Notes

Soldering

- Do not perform reflow soldering more than twice. Observe necessary precautions for handling moisture-sensitive devices as stated in the following section.
- Do not apply any pressure or force on the LED during reflow and after reflow when the LED is still hot.
- Use reflow soldering to solder the LED. Use hand soldering only for rework if unavoidable, but it must be strictly controlled to following conditions:
 - Soldering iron tip temperature = 315°C maximum.
 - Soldering duration = 3 seconds maximum.
 - Number of cycles = 1 only
 - Power of soldering iron = 50W maximum.
- Do not touch the LED package body with the soldering iron except for the soldering terminals, because it may cause damage to the LED.
- Confirm beforehand whether the functionality and performance of the LED is affected by soldering with hand soldering.

Figure 12: Recommended Lead-Free Reflow Soldering Profile

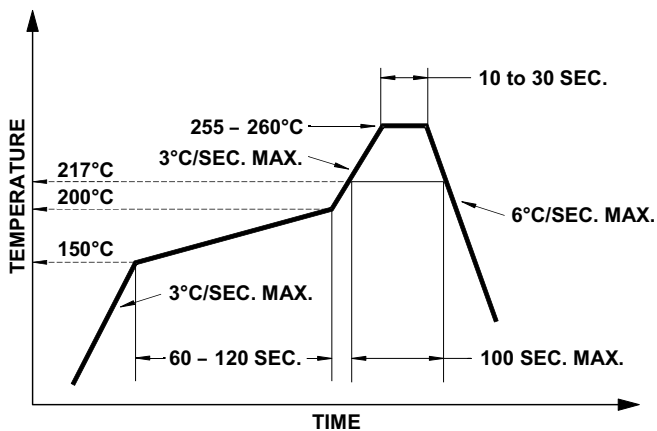
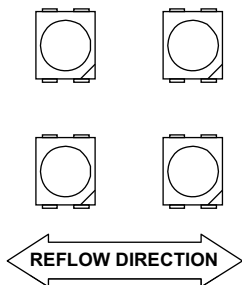

Figure 13: Recommended Board Reflow Direction



Handling of Moisture-Sensitive Devices

This product has a Moisture Sensitive Level 3 rating per JEDEC J-STD-020. Refer to Broadcom Application Note AN5305, *Handling of Moisture Sensitive Surface Mount Devices* for additional details and a review of proper handling procedures.

Before use:

- An unopened moisture barrier bag (MBB) can be stored at <40°C/90% RH for 12 months. If the actual shelf life has exceeded 12 months and the humidity indicator card (HIC) indicates that baking is not required, then it is safe to reflow the LEDs per the original MSL rating.
- Do not open the MBB prior to assembly (for example, for IQC). If unavoidable, the MBB must be properly resealed with fresh desiccant and HIC. The exposed duration must be taken in as floor life.

Control after opening the MBB:

- Read the HIC immediately upon opening of the MBB.
- Keep the LEDs at <30°/60% RH at all times, and complete all high temperature-related processes, including soldering, curing, or rework, within 168 hours.

Control for unfinished reel:

Store unused LEDs in a sealed MBB with desiccant or a desiccator at <5% RH.

Control of assembled boards:

If the PCB soldered with the LEDs is to be subjected to other high-temperature processes, store the PCB in a sealed MBB with desiccant or desiccator at <5% RH to ensure that all LEDs have not exceeded their floor life of 168 hours.

Baking is required if:

- The HIC indicator indicates a change in color for 10% and 5%, as stated on the HIC.
- The LEDs are exposed to conditions of >30°C/60% RH at any time.
- The LED's floor life exceeded 168 hours.

The recommended baking condition is: 60°C ± 5°C for 20 hours.

Baking can only be done once.

Storage:

The soldering terminals of these Broadcom LEDs are silver plated. If the LEDs are exposed in ambient environments for too long, the silver plating might be oxidized, thus affecting its solderability performance. As such, keep unused LEDs in a sealed MBB with desiccant or in a desiccator at <5% RH.

Application Precautions

- The drive current of the LED must not exceed the maximum allowable limit across temperature as stated in the data sheet. Constant current driving is recommended to ensure consistent performance.
- Circuit design must cater to the whole range of forward voltage (V_F) of the LEDs to ensure the intended drive current can always be achieved.
- The LED exhibits slightly different characteristics at different drive currents, which may result in a larger variation of performance (such as intensity, wavelength, and forward voltage). Set the application current as close as possible to the test current to minimize these variations.
- This LED is designed to have enhanced gas corrosion resistance. Its performance has been tested according to the following conditions:
 - IEC 60068-2-43: 25°C/75% RH, H2S 15ppm, 21 days.
 - IEC 60068-2-42: 25°C/75% RH, SO2 25ppm, 21 days.
 - IEC 60068-2-60: 25°C/75% RH, SO2 200ppb, NO2 200ppb, H2S 10ppb, Cl2 10ppb, 21 days.

As actual application might not be exactly similar to the test conditions, verify that the LED will not be damaged by prolonged exposure in the intended environment.
- Avoid rapid change in ambient temperatures, especially in high-humidity environments, because they cause condensation on the LED.
- If the LED is intended to be used in harsh or outdoor environments, protect the LED against damages caused by rain water, water, dust, oil, corrosive gases, external mechanical stresses, and so on.

Thermal Management

The optical, electrical, and reliability characteristics of the LED are affected by temperature. Keep the junction temperature (T_J) of the LED below the allowable limit at all times. T_J can be calculated as follows:

$$T_J = T_A + R_{\theta J-A} \times I_F \times V_{Fmax}$$

where:

T_A = Ambient temperature (°C)

$R_{\theta J-A}$ = Thermal resistance from LED junction to ambient (°C/W)

I_F = Forward current (A)

V_{Fmax} = Maximum forward voltage (V)

The complication of using this formula lies in T_A and $R_{\theta J-A}$. Actual T_A is sometimes subjective and hard to determine. $R_{\theta J-A}$ varies from system to system depending on design and is usually not known.

Another way of calculating T_J is by using the solder point temperature, T_S as follows:

$$T_J = T_S + R_{\theta J-S} \times I_F \times V_{Fmax}$$

where:

T_S = LED solder point temperature as shown in the following figure (°C)

$R_{\theta J-S}$ = Thermal resistance from junction to solder point (°C/W)

I_F = Forward current (A)

V_{Fmax} = Maximum forward voltage (V)

Figure 14: Solder Point Temperature on PCB

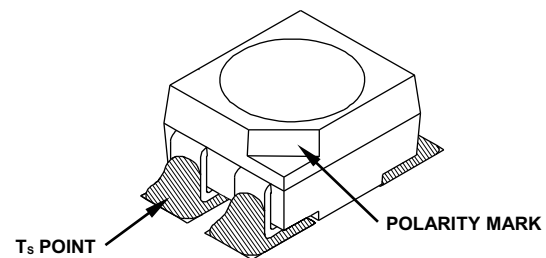

T_S can be easily measured by mounting a thermocouple on the soldering joint as shown in preceding figure, while $R_{\theta J-S}$ is provided in the data sheet. Verify the T_S of the LED in the final product to ensure that the LEDs are operating within all maximum ratings stated in the data sheet.

Eye Safety Precautions

LEDs may pose optical hazards when in operation. Do not look directly at operating LEDs because it might be harmful to the eyes. For safety reasons, use appropriate shielding or personal protective equipment.

Disclaimer

Broadcom's products and software are not specifically designed, manufactured, or authorized for sale as parts, components, or assemblies for the planning, construction, maintenance, or direct operation of a nuclear facility or for use in medical devices or applications. The customer is solely responsible, and waives all rights to make claims against Broadcom or its suppliers, for all loss, damage, expense, or liability in connection with such use.

Broadcom, the pulse logo, Connecting everything, Avago Technologies, Avago, and the A logo are among the trademarks of Broadcom and/or its affiliates in the United States, certain other countries, and/or the EU.

Copyright © 2019 Broadcom. All Rights Reserved.

The term "Broadcom" refers to Broadcom Inc. and/or its subsidiaries. For more information, please visit www.broadcom.com.

Broadcom reserves the right to make changes without further notice to any products or data herein to improve reliability, function, or design. Information furnished by Broadcom is believed to be accurate and reliable. However, Broadcom does not assume any liability arising out of the application or use of this information, nor the application or use of any product or circuit described herein, neither does it convey any license under its patent rights nor the rights of others.



Mouser Electronics

Authorized Distributor

Click to View Pricing, Inventory, Delivery & Lifecycle Information:

[Broadcom Limited:](#)

[AREQ-90C0-00000](#)