

IoT Optimized Ultra-Miniature Quartz Crystal



ABM13W SERIES



1.20 x 1.00 x 0.33mm
RoHS/RoHS II Complaint
MSL = N/A: Not Applicable

FEATURES

- World's smallest At-Cut MHz Crystal (1.20 x 1.00 x 0.33 mm package)
- Ideally suited for space constraint IoT, Wearables & Wireless applications
- Simultaneously optimized for low plating load & ESR over extended temperature range
- Enhanced performance for start-up time and power savings with Low Energy SoC's
- Low profile ideal for height constraint designs
- Available with ± 10 ppm set-tolerance

APPLICATIONS

- Wearables
- Wireless Modules
- Internet of Things (IoT)
- Bluetooth / Bluetooth Low Energy (BLE)
- Machine-to-Machine (M2M) Connectivity
- Ultra-Low Power MCU's, SoC's, Transceivers
- Near Field Communication
- ISM Band Applications

Electrical Specifications

Parameters	Min.	Typ.	Max.	Units	Note
Frequency Range	32.0000		80.0000	MHz	
Standard Available Frequencies	32.0000, 37.4000, 38.4000, 40.0000, 45.0000, 48.0000, 52.0000, 60.0000, 76.8000, 80.0000			MHz	Contact Abracon for Nonstandard Frequencies
Operation Mode	Fundamental				
Operating Temperature Range	-40		+85	°C	See Options
Storage Temperature	-40		+125	°C	
Frequency Tolerance @ +25°C	-10		+10	ppm	See options
Frequency Stability over the Operating Temperature (ref. to +25°C)	-15		+15	ppm	See options
Equivalent series resistance (R1) (over -40°C to +125°C) at 5pF plating load*		< 45	100	Ω	32.0000-32.9999MHz
		< 35	80		33.0000-36.9999MHz
		< 25	50		37.0000-80.0000MHz
Shunt capacitance (C0)			1.0	pF	
Load capacitance (CL)		5.0		pF	See options
Drive Level		10	100	μ W	
Aging (1 year)	-2		+2	ppm	@25°C \pm 3°C
Insulation Resistance	500			M Ω	@100 Vdc \pm 15V

(*) Plating Load = Load Capacitance (CL)



5101 Hidden Creek Ln Spicewood TX 78669
 Phone: 512-371-6159 | Fax: 512-351-8858
 For terms and conditions of sales, please visit:
www.abracon.com

REVISED: 09.17.2020

ABRACON IS
 ISO9001-2015
 CERTIFIED

IoT Optimized Ultra-Miniature Quartz Crystal



ABM13W SERIES



1.20 x 1.00 x 0.33mm
RoHS/RoHS II Complaint
MSL = N/A: Not Applicable

Options and Part Identification [Note 1]

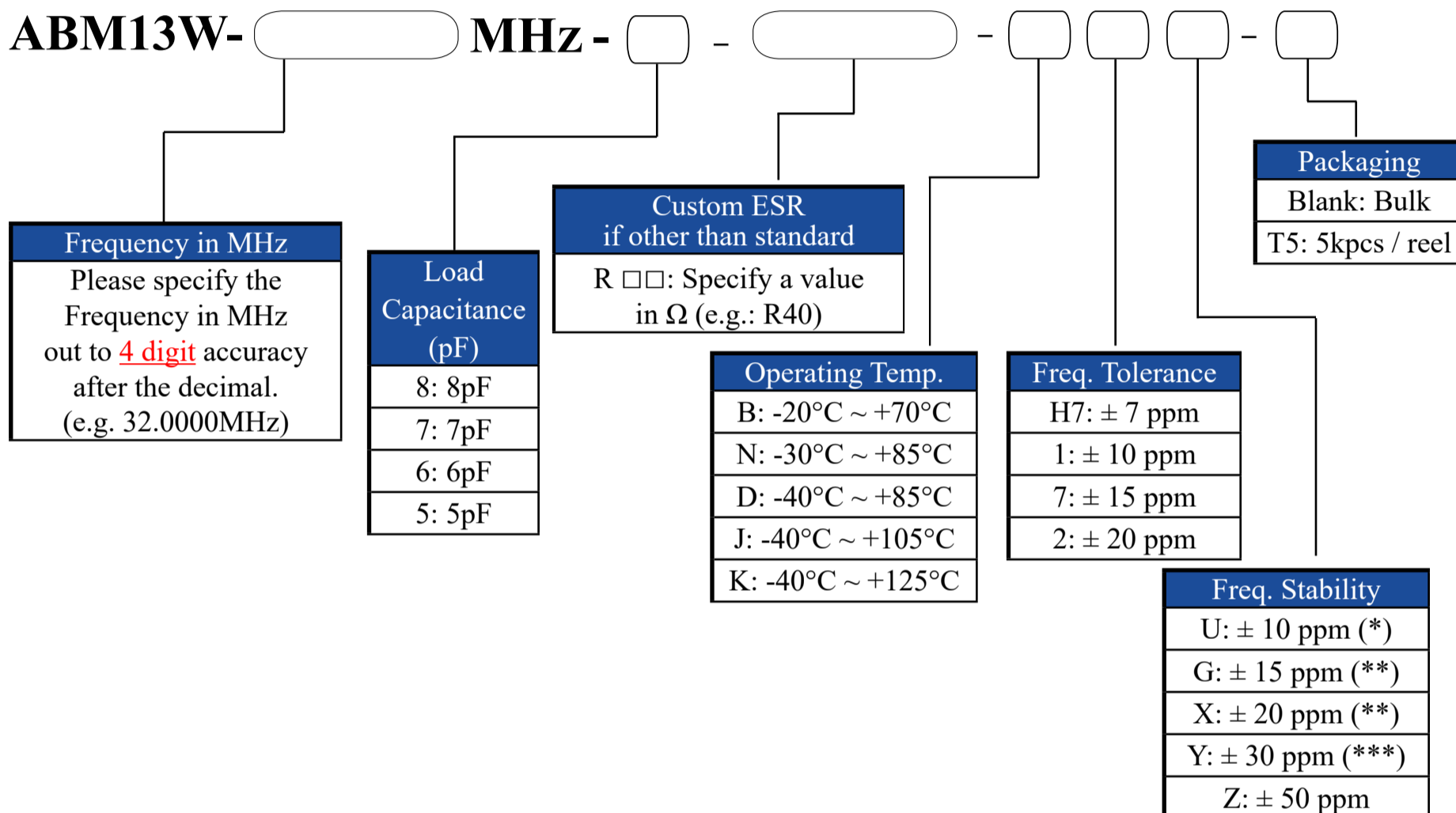

(*) Only offered @ Operating Temp. Range options: B & N
 (**) Only offered @ Operating Temp. Range options: B, N, & D
 (***) Only offered @ Operating Temp. Range options: B, N, D, & J
 Contact ABRACON for tighter Frequency Stability options.

Note 1:

Contact Abracon for part number requests with carrier frequency callouts up to 5 & 6 digit accuracy after the decimal.



5101 Hidden Creek Ln Spicewood TX 78669
 Phone: 512-371-6159 | Fax: 512-351-8858
 For terms and conditions of sales, please visit:
www.abracon.com

REVISED: 09.17.2020

ABRACON IS
 ISO9001-2015
 CERTIFIED

IoT Optimized Ultra-Miniature Quartz Crystal



ABM13W SERIES



1.20 x 1.00 x 0.33mm
 RoHS/RoHS II Complaint
 MSL = N/A: Not Applicable

Typical Frequency vs. Temperature Characteristics (ref. to +25°C):



Typical ESR (Equivalent Series Resistance) vs. Temperature Characteristics:

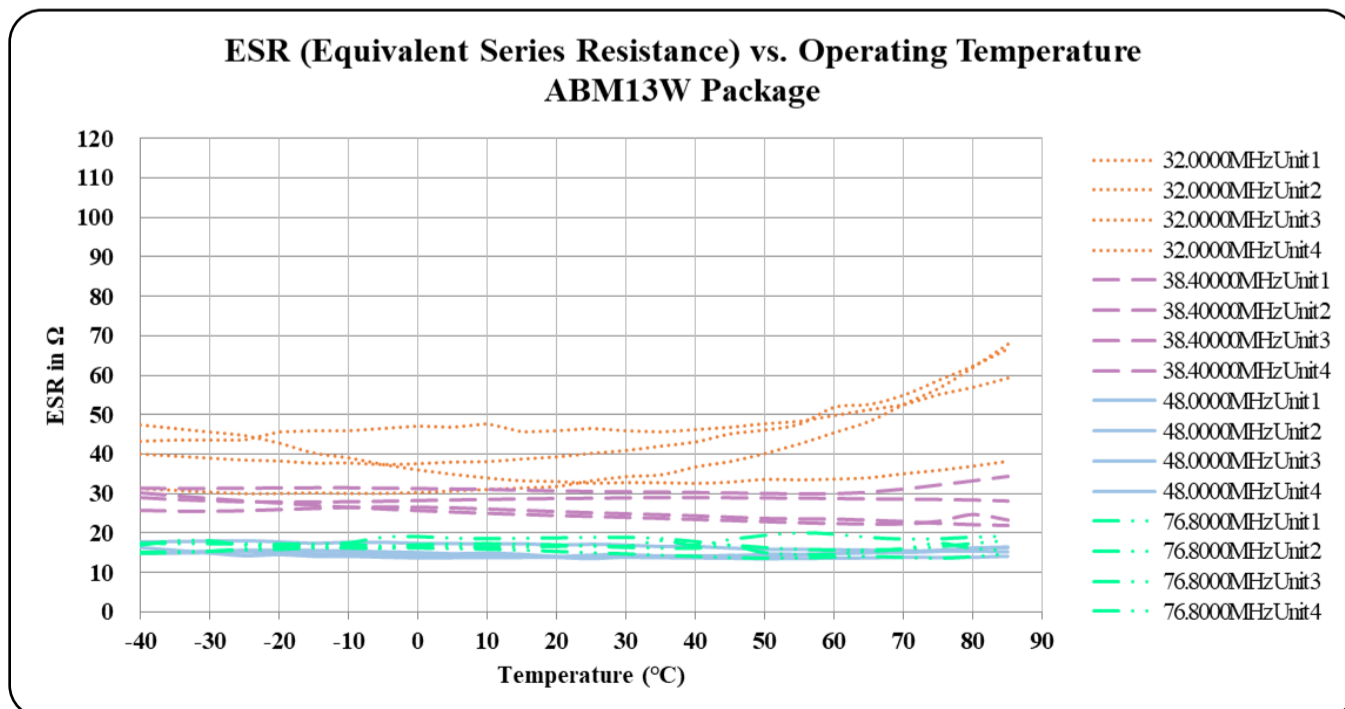

IoT Optimized Ultra-Miniature Quartz Crystal

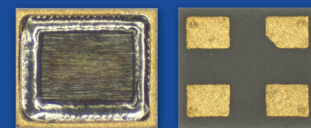

ABM13W SERIES



1.20 x 1.00 x 0.33mm
 RoHS/RoHS II Complaint
 MSL = N/A: Not Applicable

SPICE Models (based on typical values at 25°C ± 3°C):



Frequency: 32.0000MHz				Frequency: 38.4000MHz			
Plating Load: 8pF				Plating Load: 6pF			
C0	=	0.46	pF	C0	=	0.48	pF
R1	=	41.19	Ω	R1	=	22.48	Ω
L1	=	16.91	mH	L1	=	10.99	mH
C1	=	1.46	fF	C1	=	1.57	fF
Frequency: 48.0000MHz				Frequency: 76.8000MHz			
Plating Load: 6pF				Plating Load: 6pF			
C0	=	0.86	pF	C0	=	0.77	pF
R1	=	19.50	Ω	R1	=	16.97	Ω
L1	=	5.73	mH	L1	=	1.58	mH
C1	=	1.92	fF	C1	=	2.74	fF

Typical Frequency Tolerance Distribution (at 25°C ± 3°C):

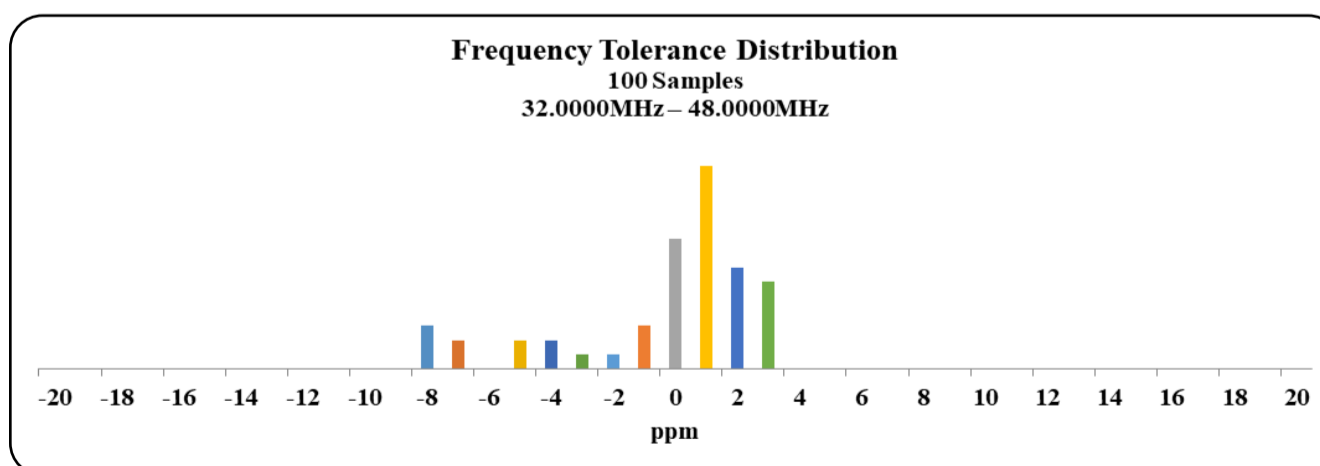

IoT Optimized Ultra-Miniature Quartz Crystal



ABM13W SERIES



1.20 x 1.00 x 0.33mm
RoHS/RoHS II Complaint
MSL = N/A: Not Applicable

Typical ESR Distribution (at 25°C ± 3°C):

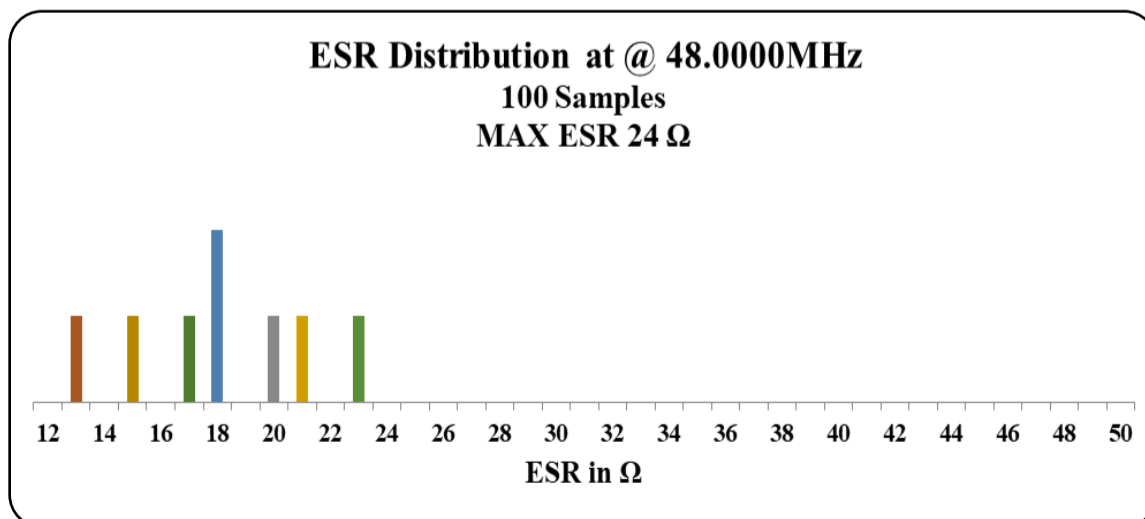
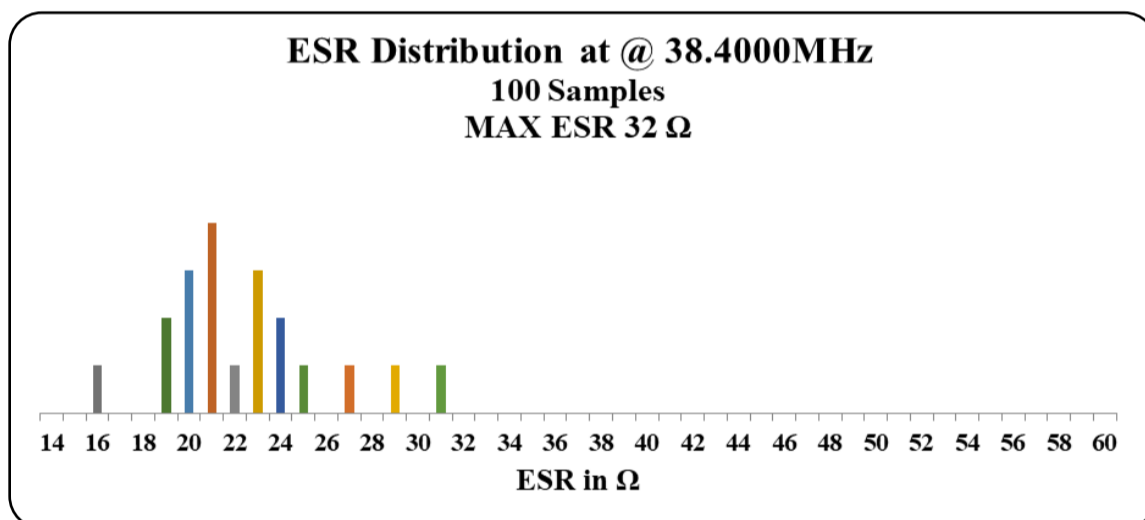
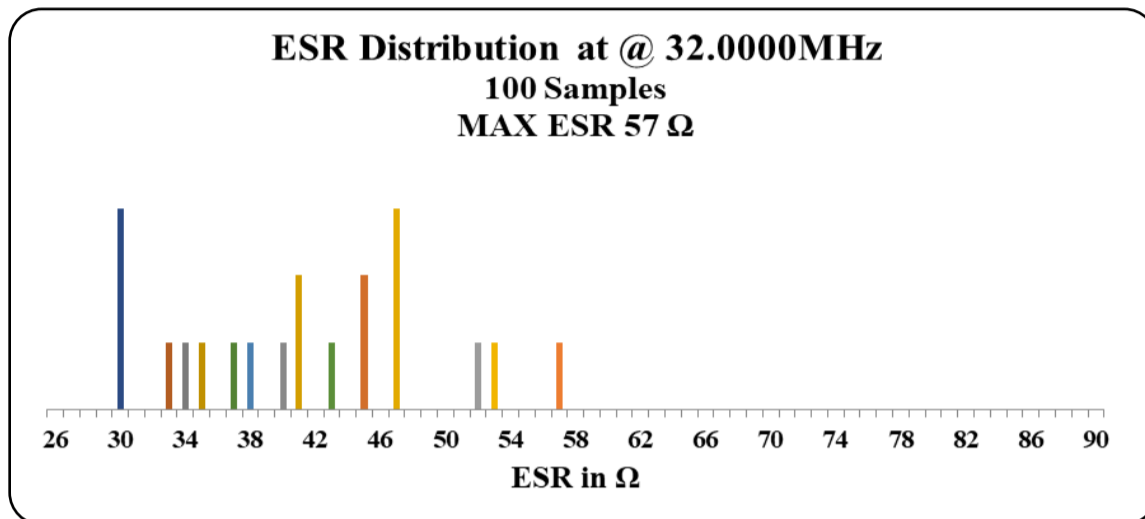

IoT Optimized Ultra-Miniature Quartz Crystal



ABM13W SERIES



1.20 x 1.00 x 0.33mm
 RoHS/RoHS II Complaint
 MSL = N/A: Not Applicable

Mechanical Dimensions



Top View



Recommended Land Pattern

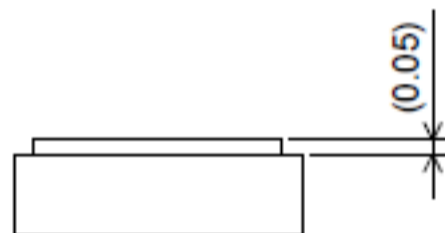
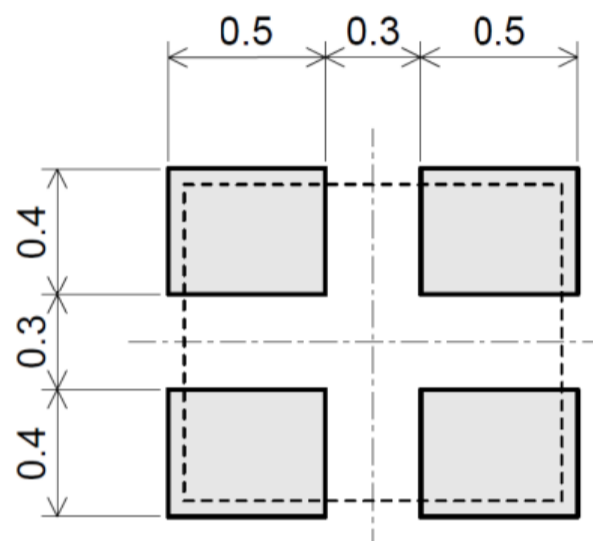

Bottom View

Internal connection

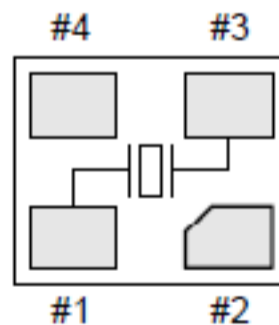

Pin #2: GND (Electrically connected to metallic package lid)
 Pin #4: NC (No internal connection, leave floating or connect to GND)

Dimensions: mm



5101 Hidden Creek Ln Spicewood TX 78669
 Phone: 512-371-6159 | Fax: 512-351-8858
 For terms and conditions of sales, please visit:
www.abracon.com

REVISED: 09.17.2020

ABRACON IS
 ISO9001-2015
 CERTIFIED

IoT Optimized Ultra-Miniature Quartz Crystal



ABM13W SERIES



1.20 x 1.00 x 0.33mm
 RoHS/RoHS II Complaint
 MSL = N/A: Not Applicable

Reflow Profile



Zone	Description	Temperature	Time
1	Preheat / Soak	$T_{SMIN} \sim T_{SMAX}$ $160 \pm 10^{\circ}C$	80 ~ 100 sec.
2	Reflow	T_L $220^{\circ}C$	50 ~ 70 sec.
3	Peak heat	T_p $260 \pm 5^{\circ}C$	5 sec. MAX.

IoT Optimized Ultra-Miniature Quartz Crystal



ABM13W SERIES



1.20 x 1.00 x 0.33mm
 RoHS/RoHS II Complaint
 MSL = N/A: Not Applicable

Packaging:

T5: Tape and reel (5,000pcs/reel)



Dimensions: mm

ATTENTION: Abracon LLC's products are COTS – Commercial-Off-The-Shelf products; suitable for Commercial, Industrial and, where designated, Automotive Applications. Abracon's products are not specifically designed for Military, Aviation, Aerospace, Life-dependant Medical applications or any application requiring high reliability where component failure could result in loss of life and/or property. For applications requiring high reliability and/or presenting an extreme operating environment, written consent and authorization from Abracon LLC is required. Please contact Abracon LLC for more information.



5101 Hidden Creek Ln Spicewood TX 78669
 Phone: 512-371-6159 | Fax: 512-351-8858
 For terms and conditions of sales, please visit:
www.abracon.com

REVISED: 09.17.2020

ABRACON IS
 ISO9001-2015
 CERTIFIED

Mouser Electronics

Authorized Distributor

Click to View Pricing, Inventory, Delivery & Lifecycle Information:

ABRACON:

[ABM13W-32.0000MHZ-8-NH7Y-T5](#) [ABM13W-48.0000MHZ-8-JH7Y-T5](#) [ABM13W-37.4000MHZ-8-BH7Z-T5](#)
[ABM13W-45.0000MHZ-8-N1U-T5](#) [ABM13W-45.0000MHZ-5-B1Z-T5](#) [ABM13W-40.0000MHZ-8-DH7X-T5](#) [ABM13W-60.0000MHZ-7-B2U-T5](#) [ABM13W-48.0000MHZ-7-D2G-T5](#) [ABM13W-80.0000MHZ-5-B2Z-T5](#) [ABM13W-45.0000MHZ-7-K2Z-T5](#) [ABM13W-52.0000MHZ-8-D1X-T5](#) [ABM13W-45.0000MHZ-8-B2U-T5](#) [ABM13W-60.0000MHZ-5-B2Y-T5](#)
[ABM13W-80.0000MHZ-8-D2Z-T5](#) [ABM13W-76.8000MHZ-5-NH7U-T5](#) [ABM13W-40.0000MHZ-6-B1Y-T5](#) [ABM13W-45.0000MHZ-5-J1Y-T5](#) [ABM13W-45.0000MHZ-7-DH7Y-T5](#) [ABM13W-32.0000MHZ-6-B2U-T5](#) [ABM13W-32.0000MHZ-5-BH7Z-T5](#) [ABM13W-45.0000MHZ-5-N1G-T5](#) [ABM13W-52.0000MHZ-7-N2Y-T5](#) [ABM13W-80.0000MHZ-6-D1G-T5](#)
[ABM13W-80.0000MHZ-7-J2Z-T5](#) [ABM13W-80.0000MHZ-7-B2G-T5](#) [ABM13W-60.0000MHZ-7-NH7U-T5](#) [ABM13W-32.0000MHZ-8-B1Z-T5](#) [ABM13W-80.0000MHZ-5-J1Y-T5](#) [ABM13W-60.0000MHZ-5-N1Z-T5](#) [ABM13W-37.4000MHZ-8-B1G-T5](#) [ABM13W-37.4000MHZ-8-K2Z-T5](#) [ABM13W-38.4000MHZ-6-B2Z-T5](#) [ABM13W-45.0000MHZ-6-N2U-T5](#)
[ABM13W-40.0000MHZ-8-D2G-T5](#) [ABM13W-80.0000MHZ-5-N2G-T5](#) [ABM13W-37.4000MHZ-8-B2Z-T5](#) [ABM13W-60.0000MHZ-8-D2Y-T5](#) [ABM13W-32.0000MHZ-7-N1U-T5](#) [ABM13W-76.8000MHZ-5-B1Z-T5](#) [ABM13W-76.8000MHZ-5-BH7Y-T5](#) [ABM13W-76.8000MHZ-6-J2Z-T5](#) [ABM13W-48.0000MHZ-8-N2Z-T5](#) [ABM13W-40.0000MHZ-6-NH7G-T5](#)
[ABM13W-40.0000MHZ-7-B1Z-T5](#) [ABM13W-48.0000MHZ-6-D2Z-T5](#) [ABM13W-76.8000MHZ-6-B2G-T5](#) [ABM13W-52.0000MHZ-7-D2G-T5](#) [ABM13W-52.0000MHZ-7-N2U-T5](#) [ABM13W-32.0000MHZ-5-B2G-T5](#) [ABM13W-32.0000MHZ-8-N1X-T5](#) [ABM13W-48.0000MHZ-8-N2X-T5](#) [ABM13W-40.0000MHZ-8-N2U-T5](#) [ABM13W-52.0000MHZ-8-N2X-T5](#)
[ABM13W-38.4000MHZ-5-B1U-T5](#) [ABM13W-48.0000MHZ-8-D2X-T5](#) [ABM13W-37.4000MHZ-5-J2Z-T5](#) [ABM13W-38.4000MHZ-6-B2X-T5](#) [ABM13W-32.0000MHZ-7-NH7G-T5](#) [ABM13W-32.0000MHZ-8-J1Y-T5](#) [ABM13W-80.0000MHZ-8-JH7Y-T5](#) [ABM13W-76.8000MHZ-8-KH7Z-T5](#) [ABM13W-45.0000MHZ-7-B2Z-T5](#) [ABM13W-45.0000MHZ-5-DH7Y-T5](#)
[ABM13W-60.0000MHZ-5-JH7Y-T5](#) [ABM13W-60.0000MHZ-7-B1Z-T5](#) [ABM13W-45.0000MHZ-7-JH7Z-T5](#) [ABM13W-48.0000MHZ-5-B2X-T5](#) [ABM13W-76.8000MHZ-7-J2Y-T5](#) [ABM13W-40.0000MHZ-8-BH7G-T5](#) [ABM13W-80.0000MHZ-7-NH7X-T5](#) [ABM13W-38.4000MHZ-5-DH7X-T5](#) [ABM13W-80.0000MHZ-7-BH7Z-T5](#) [ABM13W-37.4000MHZ-6-N2X-T5](#)
[ABM13W-45.0000MHZ-8-K1Z-T5](#) [ABM13W-60.0000MHZ-6-NH7Z-T5](#) [ABM13W-80.0000MHZ-8-D1G-T5](#) [ABM13W-38.4000MHZ-7-K1Z-T5](#) [ABM13W-76.8000MHZ-5-N2Z-T5](#) [ABM13W-48.0000MHZ-6-N1Z-T5](#) [ABM13W-60.0000MHZ-8-J1Z-T5](#) [ABM13W-76.8000MHZ-5-BH7U-T5](#) [ABM13W-45.0000MHZ-8-NH7U-T5](#) [ABM13W-32.0000MHZ-7-D2Y-T5](#)
[ABM13W-60.0000MHZ-6-N2G-T5](#) [ABM13W-40.0000MHZ-5-N1X-T5](#) [ABM13W-37.4000MHZ-8-J1Y-T5](#) [ABM13W-80.0000MHZ-5-D1X-T5](#) [ABM13W-37.4000MHZ-7-DH7Z-T5](#) [ABM13W-45.0000MHZ-6-KH7Z-T5](#) [ABM13W-37.4000MHZ-6-B1G-T5](#) [ABM13W-52.0000MHZ-7-B2Y-T5](#) [ABM13W-45.0000MHZ-7-N2G-T5](#) [ABM13W-48.0000MHZ-5-NH7X-T5](#) [ABM13W-60.0000MHZ-8-N1Y-T5](#) [ABM13W-38.4000MHZ-6-NH7X-T5](#) [ABM13W-48.0000MHZ-8-N1X-T5](#)

[ABM13W-52.0000MHZ-6-B1X-T5](#) [ABM13W-48.0000MHZ-8-D1Z-T5](#) [ABM13W-38.4000MHZ-5-K1Z-T5](#) [ABM13W-80.0000MHZ-7-DH7G-T5](#)